



**Standard** ECMA-262

14<sup>th</sup> Edition / June 2023

**ECMAScript® 2023  
Language Specification**

**Standard**

Ecma International  
Rue du Rhone 114  
CH-1204 Geneva  
Tel: +41 22 849 6000  
Fax: +41 22 849 6001  
Web: <https://www.ecma-international.org>



**COPYRIGHT PROTECTED DOCUMENT**

## ALTERNATIVE COPYRIGHT NOTICE AND COPYRIGHT LICENSE

© 2023 Ecma International

*By obtaining and/or copying this work, you (the licensee) agree that you have read, understood, and will comply with the following terms and conditions.*

*Permission under Ecma's copyright to copy, modify, prepare derivative works of, and distribute this work, with or without modification, for any purpose and without fee or royalty is hereby granted, provided that you include the following on ALL copies of the work or portions thereof, including modifications:*

*(i) The full text of this ALTERNATIVE COPYRIGHT NOTICE AND COPYRIGHT LICENSE in a location viewable to users of the redistributed or derivative work.*

*(ii) Any pre-existing intellectual property disclaimers, notices, or terms and conditions. If none exist, the Ecma alternative copyright notice should be included.*

*(iii) Notice of any changes or modifications, through a copyright statement on the document such as "This document includes material copied from or derived from [title and URI of the Ecma document]. Copyright © Ecma International."*

### **Disclaimers**

*THIS WORK IS PROVIDED "AS IS," AND COPYRIGHT HOLDERS MAKE NO REPRESENTATIONS OR WARRANTIES, EXPRESS OR IMPLIED, INCLUDING BUT NOT LIMITED TO, WARRANTIES OF MERCHANTABILITY OR FITNESS FOR ANY PARTICULAR PURPOSE OR THAT THE USE OF THE DOCUMENT WILL NOT INFRINGE ANY THIRD PARTY PATENTS, COPYRIGHTS, TRADEMARKS OR OTHER RIGHTS.*

*COPYRIGHT HOLDERS WILL NOT BE LIABLE FOR ANY DIRECT, INDIRECT, SPECIAL OR CONSEQUENTIAL DAMAGES ARISING OUT OF ANY USE OF THE DOCUMENT.*

*The name and trademarks of copyright holders may NOT be used in advertising or publicity pertaining to the work without specific, written prior permission. Title to copyright in this work will at all times remain with copyright holders.*

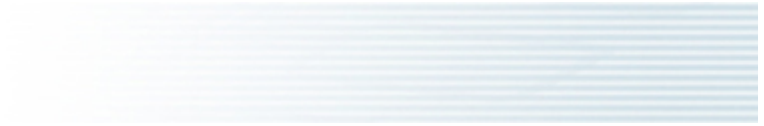

Contents	Page	
1	Scope	1
2	Conformance	1
3	Normative References	2
4	Overview	2
4.1	Web Scripting	3
4.2	Hosts and Implementations	3
4.3	ECMAScript Overview	3
4.4	Terms and Definitions	6
4.5	Organization of This Specification	11
5	Notational Conventions	12
5.1	Syntactic and Lexical Grammars	12
5.2	Algorithm Conventions	20
6	ECMAScript Data Types and Values	26
6.1	ECMAScript Language Types	26
6.2	ECMAScript Specification Types	53
7	Abstract Operations	65
7.1	Type Conversion	65
7.2	Testing and Comparison Operations	76
7.3	Operations on Objects	81
7.4	Operations on Iterator Objects	92
8	Syntax-Directed Operation	95
8.1	Runtime Semantics: Scope Analysis	96
8.2	Labels	115
8.3	Function Name Inference	124
8.4	Contains	129
8.5	Miscellaneous	132
9	Executable Code and Execution Contexts	141
9.1	Environment Records	141
9.2	PrivateEnvironment Records	159
9.3	Realms	160
9.4	Execution Contexts	162
9.5	Jobs and Host Operations to Enqueue Jobs	165
9.6	InitializeHostDefinedRealm ( )	167
9.7	Agents	168
9.8	Agent Clusters	170
9.9	Forward Progress	171
9.10	Processing Model of WeakRef and FinalizationRegistry Targets	171
9.11	ClearKeptObjects ( )	174
9.12	AddToKeptObjects ( <i>value</i> )	174
9.13	CleanupFinalizationRegistry ( <i>finalizationRegistry</i> )	174
9.14	CanBeHeldWeakly ( <i>v</i> )	175
10	Ordinary and Exotic Objects Behaviours	175
10.1	Ordinary Object Internal Methods and Internal Slots	175
10.2	ECMAScript Function Objects	184
10.3	Built-in Function Objects	194
10.4	Built-in Exotic Object Internal Methods and Slots	197
10.5	Proxy Object Internal Methods and Internal Slots	214
11	ECMAScript Language: Source Text	224
11.1	Source Text	224
11.2	Types of Source Code	226
12	ECMAScript Language: Lexical Grammar	228
12.1	Unicode Format-Control Characters	230
12.2	White Space	230
12.3	Line Terminators	231
12.4	Comments	232
12.5	Hashbang Comments	233

12.6	Tokens	233
12.7	Names and Keywords	233
12.8	unctuators	236
12.9	Literals	237
12.10	Automatic Semicolon Insertion	249
13	ECMAScript Language: Expressions	254
13.1	Identifiers	254
13.2	Primary Expression	256
13.3	Left-Hand-Side Expressions	269
13.4	Update Expressions	282
13.5	Unary Operators	284
13.6	Exponentiation Operator	287
13.7	Multiplicative Operators	287
13.8	Additive Operators	288
13.9	Bitwise Shift Operators	289
13.10	Relational Operators	289
13.11	Equality Operators	292
13.12	Binary Bitwise Operators	293
13.13	Binary Logical Operators	294
13.14	Conditional Operator ( ? : )	295
13.15	Assignment Operators	296
13.16	Comma Operator	306
14	ECMAScript Language: Statements and Declarations	307
14.1	Statement Semantics	307
14.2	Block	308
14.3	Declarations and the Variable Statement	309
14.4	Empty Statement	315
14.5	Expression Statement	315
14.6	The if Statement	315
14.7	Iteration Statements	316
14.8	The continue Statement	330
14.9	The break Statement	330
14.10	The return Statement	331
14.11	The with Statement	332
14.12	The switch Statement	332
14.13	Labelled Statements	335
14.14	The throw Statement	337
14.15	The try Statement	337
14.16	The debugger Statement	339
15	ECMAScript Language: Functions and Classes	340
15.1	Parameter Lists	340
15.2	Function Definitions	344
15.3	Arrow Function Definitions	348
15.4	Method Definitions	350
15.5	Generator Function Definition	353
15.6	Async Generator Function Definitions	358
15.7	Class Definitions	361
15.8	Async Function Definitions	373
15.9	Async Arrow Function Definitions	376
15.10	Tail Position Calls	378
16	ECMAScript Language: Scripts and Modules	384
16.1	Scripts	384
16.2	Modules	388
17	Error Handling and Language Extensions	425
17.1	Forbidden Extensions	426
18	ECMAScript Standard Built-in Objects	426
19	The Global Object	428
19.1	Value Properties of the Global Object	428
19.2	Function Properties of the Global Object	429

19.3	Constructor Properties of the Global Object	438
19.4	Other Properties of the Global Object	441
20	Fundamental Objects	442
20.1	Object Objects	442
20.2	Function Objects	451
20.3	Boolean Objects	458
20.4	Symbol Objects	459
20.5	Error Objects	464
21	Numbers and Dates	470
21.1	Number Objects	470
21.2	BigInt Objects	478
21.3	The Math Object	480
21.4	Date Objects	493
22	Text Processing	520
22.1	String Objects	520
22.2	RegExp (Regular Expression) Objects	541
23	Indexed Collections	588
23.1	Array Objects	588
23.2	TypedArray Objects	621
24	Keyed Collections	646
24.1	Map Objects	647
24.2	Set Objects	653
24.3	WeakMap Objects	658
24.4	WeakSet Objects	661
25	Structured Data	664
25.1	ArrayBuffer Objects	664
25.2	SharedArrayBuffer Objects	672
25.3	DataView Objects	675
25.4	The Atomics Object	681
25.5	The JSON Object	691
26	Managing Memory	699
26.1	WeakRef Objects	699
26.2	FinalizationRegistry Objects	701
27	Control Abstraction Objects	703
27.1	Iteration	703
27.2	Promise Objects	709
27.3	GeneratorFunction Objects	728
27.4	AsyncGeneratorFunction Objects	730
27.5	Generator Objects	733
27.6	AsyncGenerator Objects	737
27.7	AsyncFunction Objects	744
28	Reflection	748
28.1	The Reflect Object	748
28.2	Proxy Objects	751
28.3	Module Namespace Objects	752
29	Memory Model	752
29.1	Memory Model Fundamentals	752
29.2	Agent Events Records	754
29.3	Chosen Value Records	754
29.4	Candidate Executions	754
29.5	Abstract Operations for the Memory Model	755
29.6	Relations of Candidate Executions	757
29.7	Properties of Valid Executions	758
29.8	Races	761
29.9	Data Races	761
29.10	Data Race Freedom	761
29.11	Shared Memory Guidelines	761

<b>Annex A (informative) Grammar Summary</b> .....	<b>765</b>
<b>A.1 Lexical Grammar</b> .....	<b>765</b>
<b>A.2 Expressions</b> .....	<b>771</b>
<b>A.3 Statements</b> .....	<b>778</b>
<b>A.4 Functions and Classes</b> .....	<b>782</b>
<b>A.5 Scripts and Modules</b> .....	<b>786</b>
<b>A.6 Number Conversions</b> .....	<b>787</b>
<b>A.7 Time Zone Offset String Format</b> .....	<b>788</b>
<b>A.8 Regular Expressions</b> .....	<b>788</b>
<b>Annex B (normative) Additional ECMAScript Features for Web Browsers</b> .....	<b>793</b>
<b>B.1 Additional Syntax</b> .....	<b>793</b>
<b>B.2 Additional Built-in Properties</b> .....	<b>799</b>
<b>B.3 Other Additional Features</b> .....	<b>805</b>
<b>Annex C (informative) The Strict Mode of ECMAScript</b> .....	<b>813</b>
<b>Annex D (informative) Host Layering Points</b> .....	<b>815</b>
<b>D.1 Host Hooks</b> .....	<b>815</b>
<b>D.2 Host-defined Fields</b> .....	<b>815</b>
<b>D.3 Host-defined Objects</b> .....	<b>815</b>
<b>D.4 Running Jobs</b> .....	<b>816</b>
<b>D.5 Internal Methods of Exotic Objects</b> .....	<b>816</b>
<b>D.6 Built-in Objects and Methods</b> .....	<b>816</b>
<b>Annex E (informative) Corrections and Clarifications in ECMAScript 2015 with Possible Compatibility Impact</b> .....	<b>817</b>
<b>Annex F (informative) Additions and Changes That Introduce Incompatibilities with Prior Editions</b> .....	<b>819</b>
<b>Bibliography</b> .....	<b>823</b>
<b>Software License</b> .....	<b>825</b>
<b>Colophon</b> .....	<b>827</b>



## Introduction

This Ecma Standard defines the ECMAScript 2023 Language. It is the fourteenth edition of the ECMAScript Language Specification. Since publication of the first edition in 1997, ECMAScript has grown to be one of the world's most widely used general-purpose programming languages. It is best known as the language embedded in web browsers but has also been widely adopted for server and embedded applications.

ECMAScript is based on several originating technologies, the most well-known being JavaScript (Netscape) and JScript (Microsoft). The language was invented by Brendan Eich at Netscape and first appeared in that company's Navigator 2.0 browser. It has appeared in all subsequent browsers from Netscape and in all browsers from Microsoft starting with Internet Explorer 3.0.

The development of the ECMAScript Language Specification started in November 1996. The first edition of this Ecma Standard was adopted by the Ecma General Assembly of June 1997.

That Ecma Standard was submitted to ISO/IEC JTC 1 for adoption under the fast-track procedure, and approved as international standard ISO/IEC 16262, in April 1998. The Ecma General Assembly of June 1998 approved the second edition of ECMA-262 to keep it fully aligned with ISO/IEC 16262. Changes between the first and the second edition are editorial in nature.

The third edition of the Standard introduced powerful regular expressions, better string handling, new control statements, try/catch exception handling, tighter definition of errors, formatting for numeric output and minor changes in anticipation of future language growth. The third edition of the ECMAScript standard was adopted by the Ecma General Assembly of December 1999 and published as ISO/IEC 16262:2002 in June 2002.

After publication of the third edition, ECMAScript achieved massive adoption in conjunction with the World Wide Web where it has become the programming language that is supported by essentially all web browsers. Significant work was done to develop a fourth edition of ECMAScript. However, that work was not completed and not published as the fourth edition of ECMAScript but some of it was incorporated into the development of the sixth edition.

The fifth edition of ECMAScript (published as ECMA-262 5<sup>th</sup> edition) codified de facto interpretations of the language specification that have become common among browser implementations and added support for new features that had emerged since the publication of the third edition. Such features include [accessor properties](#), reflective creation and inspection of objects, program control of property attributes, additional array manipulation functions, support for the JSON object encoding format, and a strict mode that provides enhanced error checking and program security. The fifth edition was adopted by the Ecma General Assembly of December 2009.

The fifth edition was submitted to ISO/IEC JTC 1 for adoption under the fast-track procedure, and approved as international standard ISO/IEC 16262:2011. Edition 5.1 of the ECMAScript Standard incorporated minor corrections and is the same text as ISO/IEC 16262:2011. The 5.1 Edition was adopted by the Ecma General Assembly of June 2011.

Focused development of the sixth edition started in 2009, as the fifth edition was being prepared for publication. However, this was preceded by significant experimentation and language enhancement design efforts dating to the publication of the third edition in 1999. In a very real sense, the completion of the sixth edition is the culmination of a fifteen year effort. The goals for this edition included providing better support for large applications, library creation, and for use of ECMAScript as a compilation target for other languages. Some of its major enhancements included modules, class declarations, lexical block scoping, iterators and generators, promises for asynchronous programming, destructuring patterns, and proper tail calls. The ECMAScript library of built-ins was expanded to support additional data abstractions including maps, sets, and arrays of binary numeric values as well as additional support for Unicode supplementary characters in strings and regular expressions. The built-ins were also made extensible via subclassing. The sixth edition provides the foundation for regular, incremental language and library enhancements. The sixth edition was adopted by the General Assembly of June 2015.

ECMAScript 2016 was the first ECMAScript edition released under Ecma TC39's new yearly release cadence and open development process. A plain-text source document was built from the ECMAScript 2015 source document to serve as the base for further development entirely on GitHub. Over the year of this standard's development, hundreds of pull requests and issues were filed representing thousands of bug fixes, editorial fixes and other improvements. Additionally, numerous software tools were developed to aid in this effort including Ecm Markup, Ecm Markdown, and Grammarkdown. ES2016 also included support for a new exponentiation operator and adds a new method to **Array.prototype** called **includes**.

ECMAScript 2017 introduced Async Functions, Shared Memory, and Atomics along with smaller language and library enhancements, bug fixes, and editorial updates. Async functions improve the asynchronous programming experience by providing syntax for promise-returning functions. Shared Memory and Atomics introduce a new **memory model** that allows multi-agent programs to communicate using atomic operations that ensure a well-defined execution order even on parallel CPUs. It also included new static methods on Object: **Object.values**, **Object.entries**, and **Object.getPrototypeOf**.

ECMAScript 2018 introduced support for asynchronous iteration via the AsyncIterator protocol and async generators. It also included four new regular expression features: the **dotAll** flag, named capture groups, Unicode property escapes, and look-behind assertions. Lastly it included object rest and spread properties.

ECMAScript 2019 introduced a few new built-in functions: **flat** and **flatMap** on **Array.prototype** for flattening arrays, **Object.fromEntries** for directly turning the return value of **Object.entries** into a new Object, and **trimStart** and **trimEnd** on **String.prototype** as better-named alternatives to the widely implemented but non-standard **String.prototype.trimLeft** and **trimRight** built-ins. In addition, it included a few minor updates to syntax and semantics. Updated syntax included optional catch binding parameters and allowing U+2028 (LINE SEPARATOR) and U+2029 (PARAGRAPH SEPARATOR) in string literals to align with JSON. Other updates included requiring that **Array.prototype.sort** be a stable sort, requiring that **JSON.stringify** return well-formed UTF-8 regardless of input, and clarifying **Function.prototype.toString** by requiring that it either return the corresponding original source text or a standard placeholder.

ECMAScript 2020, the 11<sup>th</sup> edition, introduced the **matchAll** method for Strings, to produce an iterator for all match objects generated by a global regular expression; **import()**, a syntax to asynchronously import Modules with a dynamic specifier; **BigInt**, a new number primitive for working with arbitrary precision integers; **Promise.allSettled**, a new Promise combinator that does not short-circuit; **globalThis**, a universal way to access the global **this** value; dedicated **export \* as ns from 'module'** syntax for use within modules; increased standardization of **for-in** enumeration order; **import.meta**, a host-populated object available in Modules that may contain contextual information about the Module; as well as adding two new syntax features to improve working with “nullish” values (**null** or **undefined**): nullish coalescing, a value selection operator; and optional chaining, a property access and function invocation operator that short-circuits if the value to access/invoke is nullish.

ECMAScript 2021, the 12<sup>th</sup> edition, introduced the **replaceAll** method for Strings; **Promise.any**, a Promise combinator that short-circuits when an input value is fulfilled; **AggregateError**, a new Error type to represent multiple errors at once; logical assignment operators (**??=**, **&&=**, **||=**); **WeakRef**, for referring to a target object without preserving it from garbage collection, and **FinalizationRegistry**, to manage registration and unregistration of cleanup operations performed when target objects are garbage collected; separators for numeric literals (**1\_000**); and **Array.prototype.sort** was made more precise, reducing the amount of cases that result in an **implementation-defined sort order**.

ECMAScript 2022, the 13<sup>th</sup> edition, introduced top-level **await**, allowing the **keyword** to be used at the top level of modules; new class elements: public and private instance fields, public and private static fields, private instance methods and accessors, and private static methods and accessors; static blocks inside classes, to perform per-class evaluation initialization; the **#x in obj** syntax, to test for presence of private fields on objects; regular expression match indices via the **/d** flag, which provides start and end indices for matched substrings; the **cause** property on **Error** objects, which can be used to record a causation chain in errors; the **at** method for Strings, Arrays, and TypedArrays, which allows relative indexing; and **Object.hasOwn**, a convenient alternative to **Object.prototype.hasOwnProperty**.

ECMAScript 2023, the 14<sup>th</sup> edition, introduced the **toSorted**, **toReversed**, **with**, **findLast**, and **findLastIndex** methods on **Array.prototype** and **TypedArray.prototype**, as well as the

**toSpliced** method on **Array.prototype**; added support for **#!** comments at the beginning of files to better facilitate executable ECMAScript files; and allowed the use of most Symbols as keys in weak collections.

Dozens of individuals representing many organizations have made very significant contributions within Ecma TC39 to the development of this edition and to the prior editions. In addition, a vibrant community has emerged supporting TC39's ECMAScript efforts. This community has reviewed numerous drafts, filed thousands of bug reports, performed implementation experiments, contributed test suites, and educated the world-wide developer community about ECMAScript. Unfortunately, it is impossible to identify and acknowledge every person and organization who has contributed to this effort.

Allen Wirfs-Brock

ECMA-262, Project Editor, 6<sup>th</sup> Edition

Brian Terlson

ECMA-262, Project Editor, 7<sup>th</sup> through 10<sup>th</sup> Editions

Jordan Harband

ECMA-262, Project Editor, 10<sup>th</sup> through 12<sup>th</sup> Editions

Shu-yu Guo

ECMA-262, Project Editor, 12<sup>th</sup> through 14<sup>th</sup> Editions

Michael Ficarra

ECMA-262, Project Editor, 12<sup>th</sup> through 14<sup>th</sup> Editions

Kevin Gibbons

ECMA-262, Project Editor, 12<sup>th</sup> through 14<sup>th</sup> Editions

This Ecma Standard was developed by Technical Committee 39 and was adopted by the General Assembly of June 2023.

## About this Specification

The document at <https://tc39.es/ecma262/> is the most accurate and up-to-date ECMAScript specification. It contains the content of the most recent yearly snapshot plus any [finished proposals](#) (those that have reached Stage 4 in the [proposal process](#) and thus are implemented in several implementations and will be in the next practical revision) since that snapshot was taken.

This document is available as [a single page](#) and as [multiple pages](#).

## Contributing to this Specification

This specification is developed on GitHub with the help of the ECMAScript community. There are a number of ways to contribute to the development of this specification:

GitHub Repository: <https://github.com/tc39/ecma262>

Issues: [All Issues](#), [File a New Issue](#)

Pull Requests: [All Pull Requests](#), [Create a New Pull Request](#)

Test Suite: [Test262](#)

Editors:

- [Shu-yu Guo \(@\\_shu\)](#)
- [Michael Ficarra \(@smooshMap\)](#)
- [Kevin Gibbons \(@bakkoting\)](#)

Community:

- Discourse: <https://es.discourse.group>
- Chat: [Matrix](#)
- Mailing List Archives: <https://esdiscuss.org/>

Refer to the [colophon](#) for more information on how this document is created.

- Community:
- Matrix: [#tc39:matrix.org](#)
- Matrix: [#tc39-ecma402:matrix.org](#)

Refer to the [colophon](#) for more information on how this document is created.

# ECMAScript® 2023 Language Specification

## 1 Scope

This Standard defines the ECMAScript 2023 general-purpose programming language.

## 2 Conformance

A conforming implementation of ECMAScript must provide and support all the types, values, objects, properties, functions, and program syntax and semantics described in this specification.

A conforming implementation of ECMAScript must interpret source text input in conformance with the latest version of the Unicode Standard and ISO/IEC 10646.

A conforming implementation of ECMAScript that provides an application programming interface (API) that supports programs that need to adapt to the linguistic and cultural conventions used by different human languages and countries must implement the interface defined by the most recent edition of ECMA-402 that is compatible with this specification.

A conforming implementation of ECMAScript may provide additional types, values, objects, properties, and functions beyond those described in this specification. In particular, a conforming implementation of ECMAScript may provide properties not described in this specification, and values for those properties, for objects that are described in this specification.

A conforming implementation of ECMAScript may support program and regular expression syntax not described in this specification. In particular, a conforming implementation of ECMAScript may support program syntax that makes use of any “future [reserved words](#)” noted in subclause [12.7.2](#) of this specification.

A conforming implementation of ECMAScript must not implement any extension that is listed as a Forbidden Extension in subclause [17.1](#).

A conforming implementation of ECMAScript must not redefine any facilities that are not [implementation-defined](#), [implementation-approximated](#), or [host-defined](#).

A conforming implementation of ECMAScript may choose to implement or not implement *Normative Optional* subclauses. If any Normative Optional behaviour is implemented, all of the behaviour in the containing Normative Optional clause must be implemented. A Normative Optional clause is denoted in this specification with the words “Normative Optional” in a coloured box, as shown below.

### NORMATIVE OPTIONAL

#### 2.1 Example Normative Optional Clause Heading

Example clause contents.

A conforming implementation of ECMAScript must implement *Legacy* subclauses, unless they are also marked as Normative Optional. All of the language features and behaviours specified within Legacy subclauses have one or more undesirable characteristics. However, their continued usage in existing applications prevents their removal from this specification. These features are not considered part of the core ECMAScript language. Programmers should not use or assume the existence of these features and behaviours when writing new ECMAScript code.

## LEGACY

### 2.2 Example Legacy Clause Heading

Example clause contents.

## NORMATIVE OPTIONAL, LEGACY

### 2.3 Example Legacy Normative Optional Clause Heading

Example clause contents.

## 3 Normative References

The following referenced documents are indispensable for the application of this document. For dated references, only the edition cited applies. For undated references, the latest edition of the referenced document (including any amendments) applies.

ISO/IEC 10646 *Information Technology — Universal Multiple-Octet Coded Character Set (UCS) plus Amendment 1:2005, Amendment 2:2006, Amendment 3:2008, and Amendment 4:2008*, plus additional amendments and corrigenda, or successor

ECMA-402, *ECMAScript 2015 Internationalization API Specification*.  
<https://ecma-international.org/publications/standards/Ecma-402.htm>

ECMA-404, *The JSON Data Interchange Format*.  
<https://ecma-international.org/publications/standards/Ecma-404.htm>

## 4 Overview

This section contains a non-normative overview of the ECMAScript language.

ECMAScript is an object-oriented programming language for performing computations and manipulating computational objects within a [host environment](#). ECMAScript as defined here is not intended to be computationally self-sufficient; indeed, there are no provisions in this specification for input of external data or output of computed results. Instead, it is expected that the computational environment of an ECMAScript program will provide not only the objects and other facilities described in this specification but also certain environment-specific objects, whose description and behaviour are beyond the scope of this specification except to indicate that they may provide certain properties that can be accessed and certain functions that can be called from an ECMAScript program.

ECMAScript was originally designed to be used as a scripting language, but has become widely used as a general-purpose programming language. A *scripting language* is a programming language that is used to manipulate, customize, and automate the facilities of an existing system. In such systems, useful functionality is already available through a user interface, and the scripting language is a mechanism for exposing that functionality to program control. In this way, the existing system is said to provide a [host environment](#) of objects and facilities, which completes the capabilities of the scripting language. A scripting language is intended for use by both professional and non-professional programmers.

ECMAScript was originally designed to be a *Web scripting language*, providing a mechanism to enliven Web pages in browsers and to perform server computation as part of a Web-based client-server architecture. ECMAScript is now used to provide core scripting capabilities for a variety of [host environments](#). Therefore the core language is specified in this document apart from any particular [host environment](#).

ECMAScript usage has moved beyond simple scripting and it is now used for the full spectrum of programming tasks in many different environments and scales. As the usage of ECMAScript has expanded, so have the features and facilities it provides. ECMAScript is now a fully featured general-purpose programming language.

## 4.1 Web Scripting

A web browser provides an ECMAScript [host environment](#) for client-side computation including, for instance, objects that represent windows, menus, pop-ups, dialog boxes, text areas, anchors, frames, history, cookies, and input/output. Further, the [host environment](#) provides a means to attach scripting code to events such as change of focus, page and image loading, unloading, error and abort, selection, form submission, and mouse actions. Scripting code appears within the HTML and the displayed page is a combination of user interface elements and fixed and computed text and images. The scripting code is reactive to user interaction, and there is no need for a main program.

A web server provides a different [host environment](#) for server-side computation including objects representing requests, clients, and files; and mechanisms to lock and share data. By using browser-side and server-side scripting together, it is possible to distribute computation between the client and server while providing a customized user interface for a Web-based application.

Each Web browser and server that supports ECMAScript supplies its own [host environment](#), completing the ECMAScript execution environment.

## 4.2 Hosts and Implementations

To aid integrating ECMAScript into [host environments](#), this specification defers the definition of certain facilities (e.g., [abstract operations](#)), either in whole or in part, to a source outside of this specification. Editorially, this specification distinguishes the following kinds of deferrals.

An *implementation* is an external source that further defines facilities enumerated in Annex D or those that are marked as [implementation-defined](#) or [implementation-approximated](#). In informal use, an implementation refers to a concrete artefact, such as a particular web browser.

An *implementation-defined* facility is one that defers its definition to an external source without further qualification. This specification does not make any recommendations for particular behaviours, and conforming implementations are free to choose any behaviour within the constraints put forth by this specification.

An *implementation-approximated* facility is one that defers its definition to an external source while recommending an ideal behaviour. While conforming implementations are free to choose any behaviour within the constraints put forth by this specification, they are encouraged to strive to approximate the ideal. Some mathematical operations, such as [Math.exp](#), are [implementation-approximated](#).

A *host* is an external source that further defines facilities listed in Annex D but does not further define other [implementation-defined](#) or [implementation-approximated](#) facilities. In informal use, a [host](#) refers to the set of all implementations, such as the set of all web browsers, that interface with this specification in the same way via Annex D. A [host](#) is often an external specification, such as WHATWG HTML (<https://html.spec.whatwg.org/>). In other words, facilities that are [host-defined](#) are often further defined in external specifications.

A *host hook* is an abstract operation that is defined in whole or in part by an external source. All [host hooks](#) must be listed in Annex D. A [host hook](#) must conform to at least the following requirements:

- It must return either a [normal completion](#) or a [throw completion](#).

A *host-defined* facility is one that defers its definition to an external source without further qualification and is listed in Annex D. Implementations that are not *hosts* may also provide definitions for *host-defined* facilities.

A *host environment* is a particular choice of definition for all *host-defined* facilities. A *host environment* typically includes objects or functions which allow obtaining input and providing output as *host-defined* properties of the *global object*.

This specification follows the editorial convention of always using the most specific term. For example, if a facility is *host-defined*, it should not be referred to as *implementation-defined*.

Both *hosts* and implementations may interface with this specification via the language types, specification types, *abstract operations*, grammar productions, intrinsic objects, and intrinsic symbols defined herein.

## 4.3 ECMAScript Overview

The following is an informal overview of ECMAScript—not all parts of the language are described. This overview is not part of the standard proper.

ECMAScript is object-based: basic language and *host* facilities are provided by objects, and an ECMAScript program is a cluster of communicating objects. In ECMAScript, an *object* is a collection of zero or more *properties* each with *attributes* that determine how each property can be used—for example, when the Writable attribute for a property is set to **false**, any attempt by executed ECMAScript code to assign a different value to the property fails. Properties are containers that hold other objects, *primitive values*, or *functions*. A primitive value is a member of one of the following built-in types: **Undefined**, **Null**, **Boolean**, **Number**, **BigInt**, **String**, and **Symbol**; an object is a member of the built-in type **Object**; and a function is a callable object. A function that is associated with an object via a property is called a *method*.

ECMAScript defines a collection of *built-in objects* that round out the definition of ECMAScript entities. These built-in objects include the *global object*; objects that are fundamental to the *runtime semantics* of the language including **Object**, **Function**, **Boolean**, **Symbol**, and various **Error** objects; objects that represent and manipulate numeric values including **Math**, **Number**, and **Date**; the text processing objects **String** and **RegExp**; objects that are indexed collections of values including **Array** and nine different kinds of Typed Arrays whose elements all have a specific numeric data representation; keyed collections including **Map** and **Set** objects; objects supporting structured data including the **JSON** object, **ArrayBuffer**, **SharedArrayBuffer**, and **DataView**; objects supporting control abstractions including generator functions and **Promise** objects; and reflection objects including **Proxy** and **Reflect**.

ECMAScript also defines a set of built-in *operators*. ECMAScript operators include various unary operations, multiplicative operators, additive operators, bitwise shift operators, relational operators, equality operators, binary bitwise operators, binary logical operators, assignment operators, and the comma operator.

Large ECMAScript programs are supported by *modules* which allow a program to be divided into multiple sequences of statements and declarations. Each module explicitly identifies declarations it uses that need to be provided by other modules and which of its declarations are available for use by other modules.

ECMAScript syntax intentionally resembles Java syntax. ECMAScript syntax is relaxed to enable it to serve as an easy-to-use scripting language. For example, a variable is not required to have its type declared nor are types associated with properties, and defined functions are not required to have their declarations appear textually before calls to them.

### 4.3.1 Objects

Even though ECMAScript includes syntax for class definitions, ECMAScript objects are not fundamentally class-based such as those in C++, Smalltalk, or Java. Instead objects may be created in various ways including via a literal notation or via *constructors* which create objects and then execute code that initializes all or part of them by assigning initial values to their properties. Each *constructor* is a function that has a property named **"prototype"** that is used to implement *prototype-based inheritance* and *shared properties*.



Objects are created by using **constructors** in **new** expressions; for example, **new Date(2009, 11)** creates a new Date object. Invoking a **constructor** without using **new** has consequences that depend on the **constructor**. For example, **Date()** produces a string representation of the current date and time rather than an object.

Every object created by a **constructor** has an implicit reference (called the object's *prototype*) to the value of its **constructor's "prototype"** property. Furthermore, a prototype may have a non-**null** implicit reference to its prototype, and so on; this is called the *prototype chain*. When a reference is made to a property in an object, that reference is to the property of that name in the first object in the prototype chain that contains a property of that name. In other words, first the object mentioned directly is examined for such a property; if that object contains the named property, that is the property to which the reference refers; if that object does not contain the named property, the prototype for that object is examined next; and so on.

Figure 1: Object/Prototype Relationships

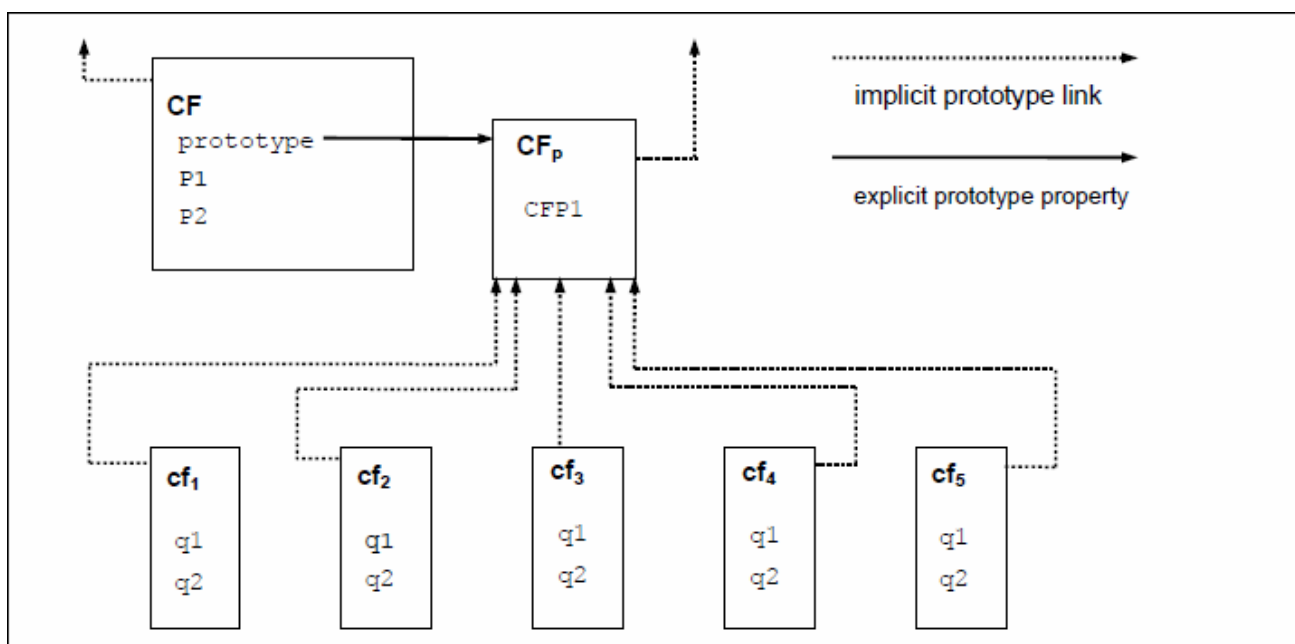

In a class-based object-oriented language, in general, state is carried by instances, methods are carried by classes, and inheritance is only of structure and behaviour. In ECMAScript, the state and methods are carried by objects, while structure, behaviour, and state are all inherited.

All objects that do not directly contain a particular property that their prototype contains share that property and its value. Figure 1 illustrates this:

**CF** is a **constructor** (and also an object). Five objects have been created by using **new** expressions: **cf<sub>1</sub>**, **cf<sub>2</sub>**, **cf<sub>3</sub>**, **cf<sub>4</sub>**, and **cf<sub>5</sub>**. Each of these objects contains properties named "**q1**" and "**q2**". The dashed lines represent the implicit prototype relationship; so, for example, **cf<sub>3</sub>**'s prototype is **CF<sub>p</sub>**. The **constructor**, **CF**, has two properties itself, named "**P1**" and "**P2**", which are not visible to **CF<sub>p</sub>**, **cf<sub>1</sub>**, **cf<sub>2</sub>**, **cf<sub>3</sub>**, **cf<sub>4</sub>**, or **cf<sub>5</sub>**. The property named "**CFP1**" in **CF<sub>p</sub>** is shared by **cf<sub>1</sub>**, **cf<sub>2</sub>**, **cf<sub>3</sub>**, **cf<sub>4</sub>**, and **cf<sub>5</sub>** (but not by **CF**), as are any properties found in **CF<sub>p</sub>**'s implicit prototype chain that are not named "**q1**", "**q2**", or "**CFP1**". Notice that there is no implicit prototype link between **CF** and **CF<sub>p</sub>**.

Unlike most class-based object languages, properties can be added to objects dynamically by assigning values to them. That is, **constructors** are not required to name or assign values to all or any of the constructed object's properties. In the above diagram, one could add a new shared property for **cf<sub>1</sub>**, **cf<sub>2</sub>**, **cf<sub>3</sub>**, **cf<sub>4</sub>**, and **cf<sub>5</sub>** by assigning a new value to the property in **CF<sub>p</sub>**.

Although ECMAScript objects are not inherently class-based, it is often convenient to define class-like abstractions based upon a common pattern of **constructor** functions, prototype objects, and methods. The

ECMAScript built-in objects themselves follow such a class-like pattern. Beginning with ECMAScript 2015, the ECMAScript language includes syntactic class definitions that permit programmers to concisely define objects that conform to the same class-like abstraction pattern used by the built-in objects.

### 4.3.2 The Strict Variant of ECMAScript

The ECMAScript Language recognizes the possibility that some users of the language may wish to restrict their usage of some features available in the language. They might do so in the interests of security, to avoid what they consider to be error-prone features, to get enhanced error checking, or for other reasons of their choosing. In support of this possibility, ECMAScript defines a strict variant of the language. The strict variant of the language excludes some specific syntactic and semantic features of the regular ECMAScript language and modifies the detailed semantics of some features. The strict variant also specifies additional error conditions that must be reported by throwing error exceptions in situations that are not specified as errors by the non-strict form of the language.

The strict variant of ECMAScript is commonly referred to as the *strict mode* of the language. Strict mode selection and use of the strict mode syntax and semantics of ECMAScript is explicitly made at the level of individual [ECMAScript source text](#) units as described in [11.2.2](#). Because strict mode is selected at the level of a syntactic source text unit, strict mode only imposes restrictions that have local effect within such a source text unit. Strict mode does not restrict or modify any aspect of the ECMAScript semantics that must operate consistently across multiple source text units. A complete ECMAScript program may be composed of both strict mode and non-strict mode [ECMAScript source text](#) units. In this case, strict mode only applies when actually executing code that is defined within a strict mode source text unit.

In order to conform to this specification, an ECMAScript implementation must implement both the full unrestricted ECMAScript language and the strict variant of the ECMAScript language as defined by this specification. In addition, an implementation must support the combination of unrestricted and strict mode source text units into a single composite program.

## 4.4 Terms and Definitions

For the purposes of this document, the following terms and definitions apply.

### 4.4.1 implementation-approximated

an [implementation-approximated](#) facility is defined in whole or in part by an external source but has a recommended, ideal behaviour in this specification

### 4.4.2 implementation-defined

an [implementation-defined](#) facility is defined in whole or in part by an external source to this specification

### 4.4.3 host-defined

same as [implementation-defined](#)

NOTE Editorially, see clause [4.2](#).

### 4.4.4 type

set of data values as defined in clause [6](#)

#### 4.4.5 primitive value

member of one of the types Undefined, Null, Boolean, Number, BigInt, Symbol, or String as defined in clause 6

NOTE A primitive value is a datum that is represented directly at the lowest level of the language implementation.

#### 4.4.6 object

member of the type Object

NOTE An object is a collection of properties and has a single prototype object. The prototype may be **null**.

#### 4.4.7 constructor

[function object](#) that creates and initializes objects

NOTE The value of a [constructor's "prototype"](#) property is a prototype object that is used to implement inheritance and shared properties.

#### 4.4.8 prototype

object that provides shared properties for other objects

NOTE When a [constructor](#) creates an object, that object implicitly references the [constructor's "prototype"](#) property for the purpose of resolving property references. The [constructor's "prototype"](#) property can be referenced by the program expression [constructor.prototype](#), and properties added to an object's prototype are shared, through inheritance, by all objects sharing the prototype. Alternatively, a new object may be created with an explicitly specified prototype by using the [Object.create](#) built-in function.

#### 4.4.9 ordinary object

object that has the default behaviour for the essential internal methods that must be supported by all objects

#### 4.4.10 exotic object

object that does not have the default behaviour for one or more of the essential internal methods

NOTE Any object that is not an [ordinary object](#) is an [exotic object](#).

#### 4.4.11 standard object

object whose semantics are defined by this specification

#### 4.4.12 built-in object

object specified and supplied by an ECMAScript implementation

**NOTE** Standard built-in objects are defined in this specification. An ECMAScript implementation may specify and supply additional kinds of built-in objects. A *built-in constructor* is a built-in object that is also a *constructor*.

#### 4.4.13 undefined value

primitive value used when a variable has not been assigned a value

#### 4.4.14 Undefined type

type whose sole value is the **undefined** value

#### 4.4.15 null value

primitive value that represents the intentional absence of any object value

#### 4.4.16 Null type

type whose sole value is the **null** value

#### 4.4.17 Boolean value

member of the *Boolean type*

**NOTE** There are only two Boolean values, **true** and **false**.

#### 4.4.18 Boolean type

type consisting of the primitive values **true** and **false**

#### 4.4.19 Boolean object

member of the Object type that is an instance of the standard built-in Boolean *constructor*

**NOTE** A Boolean object is created by using the Boolean *constructor* in a **new** expression, supplying a Boolean value as an argument. The resulting object has an internal slot whose value is the Boolean value. A Boolean object can be coerced to a Boolean value.

#### 4.4.20 String value

primitive value that is a [finite](#) ordered sequence of zero or more 16-bit unsigned [integer](#) values

**NOTE** A String value is a member of the [String type](#). Each [integer](#) value in the sequence usually represents a single 16-bit unit of UTF-16 text. However, ECMAScript does not place any restrictions or requirements on the values except that they must be 16-bit unsigned [integers](#).

#### 4.4.21 String type

set of all possible String values

#### 4.4.22 String object

member of the Object type that is an instance of the standard built-in String [constructor](#)

**NOTE** A String object is created by using the String [constructor](#) in a **new** expression, supplying a String value as an argument. The resulting object has an internal slot whose value is the String value. A String object can be coerced to a String value by calling the String [constructor](#) as a function ([22.1.1.1](#)).

#### 4.4.23 Number value

primitive value corresponding to a double-precision 64-bit binary format [IEEE 754-2019](#) value

**NOTE** A Number value is a member of the [Number type](#) and is a direct representation of a number.

#### 4.4.24 Number type

set of all possible Number values including the special “Not-a-Number” (NaN) value, positive infinity, and negative infinity

#### 4.4.25 Number object

member of the Object type that is an instance of the standard built-in Number [constructor](#)

**NOTE** A Number object is created by using the Number [constructor](#) in a **new** expression, supplying a Number value as an argument. The resulting object has an internal slot whose value is the Number value. A Number object can be coerced to a Number value by calling the Number [constructor](#) as a function ([21.1.1.1](#)).

#### 4.4.26 Infinity

Number value that is the positive infinite Number value

#### 4.4.27 NaN

Number value that is an [IEEE 754-2019](#) “Not-a-Number” value

#### 4.4.28 BigInt value

primitive value corresponding to an arbitrary-precision [integer](#) value

#### 4.4.29 BigInt type

set of all possible BigInt values

#### 4.4.30 BigInt object

member of the Object type that is an instance of the standard built-in BigInt [constructor](#)

#### 4.4.31 Symbol value

primitive value that represents a unique, non-String Object [property key](#)

#### 4.4.32 Symbol type

set of all possible Symbol values

#### 4.4.33 Symbol object

member of the Object type that is an instance of the standard built-in Symbol [constructor](#)

#### 4.4.34 function

member of the Object type that may be invoked as a subroutine

**NOTE** In addition to its properties, a function contains executable code and state that determine how it behaves when invoked. A function's code may or may not be written in ECMAScript.

#### 4.4.35 built-in function

built-in object that is a function

**NOTE** Examples of built-in functions include [parseInt](#) and [Math.exp](#). A [host](#) or implementation may provide additional built-in functions that are not described in this specification.

#### 4.4.36 property

part of an object that associates a key (either a String value or a Symbol value) and a value

**NOTE** Depending upon the form of the property the value may be represented either directly as a data value (a primitive value, an object, or a [function object](#)) or indirectly by a pair of accessor functions.

#### 4.4.37 method

function that is the value of a property

**NOTE** When a function is called as a method of an object, the object is passed to the function as its **this** value.

#### 4.4.38 built-in method

method that is a built-in function

**NOTE** Standard built-in methods are defined in this specification. A [host](#) or implementation may provide additional built-in methods that are not described in this specification.

#### 4.4.39 attribute

internal value that defines some characteristic of a property

#### 4.4.40 own property

property that is directly contained by its object

#### 4.4.41 inherited property

property of an object that is not an own property but is a property (either own or inherited) of the object's prototype

### 4.5 Organization of This Specification

The remainder of this specification is organized as follows:

Clause [5](#) defines the notational conventions used throughout the specification.

Clauses [6](#) through [10](#) define the execution environment within which ECMAScript programs operate.

Clauses [11](#) through [17](#) define the actual ECMAScript programming language including its syntactic encoding and the execution semantics of all language features.

Clauses [18](#) through [28](#) define the ECMAScript standard library. They include the definitions of all of the standard objects that are available for use by ECMAScript programs as they execute.

Clause [29](#) describes the memory consistency model of accesses on SharedArrayBuffer-backed memory and methods of the Atomics object.

## 5 Notational Conventions

### 5.1 Syntactic and Lexical Grammars

#### 5.1.1 Context-Free Grammars

A *context-free grammar* consists of a number of *productions*. Each production has an abstract symbol called a *nonterminal* as its *left-hand side*, and a sequence of zero or more nonterminal and *terminal* symbols as its *right-hand side*. For each grammar, the terminal symbols are drawn from a specified alphabet.

A *chain production* is a production that has exactly one nonterminal symbol on its right-hand side along with zero or more terminal symbols.

Starting from a sentence consisting of a single distinguished nonterminal, called the *goal symbol*, a given context-free grammar specifies a *language*, namely, the (perhaps infinite) set of possible sequences of terminal symbols that can result from repeatedly replacing any nonterminal in the sequence with a right-hand side of a production for which the nonterminal is the left-hand side.

#### 5.1.2 The Lexical and RegExp Grammars

A *lexical grammar* for ECMAScript is given in clause 12. This grammar has as its terminal symbols Unicode code points that conform to the rules for *SourceCharacter* defined in 11.1. It defines a set of productions, starting from the *goal symbol* *InputElementDiv*, *InputElementTemplateTail*, *InputElementRegExp*, *InputElementRegExpOrTemplateTail*, or *InputElementHashbangOrRegExp*, that describe how sequences of such code points are translated into a sequence of input elements.

Input elements other than white space and comments form the terminal symbols for the syntactic grammar for ECMAScript and are called ECMAScript *tokens*. These tokens are the *reserved words*, identifiers, literals, and punctuators of the ECMAScript language. Moreover, line terminators, although not considered to be tokens, also become part of the stream of input elements and guide the process of automatic semicolon insertion (12.10). Simple white space and single-line comments are discarded and do not appear in the stream of input elements for the syntactic grammar. A *MultiLineComment* (that is, a comment of the form */\*...\*/* regardless of whether it spans more than one line) is likewise simply discarded if it contains no line terminator; but if a *MultiLineComment* contains one or more line terminators, then it is replaced by a single line terminator, which becomes part of the stream of input elements for the syntactic grammar.

A *RegExp grammar* for ECMAScript is given in 22.2.1. This grammar also has as its terminal symbols the code points as defined by *SourceCharacter*. It defines a set of productions, starting from the *goal symbol* *Pattern*, that describe how sequences of code points are translated into regular expression patterns.

Productions of the lexical and RegExp grammars are distinguished by having two colons “::” as separating punctuation. The lexical and RegExp grammars share some productions.

#### 5.1.3 The Numeric String Grammar

A *numeric string grammar* appears in 7.1.4.1. It has as its terminal symbols *SourceCharacter*, and is used for translating Strings into numeric values starting from the *goal symbol* *StringNumericLiteral* (which is similar to but distinct from the *lexical grammar for numeric literals*).

Productions of the numeric string grammar are distinguished by having three colons “:::” as punctuation, and are never used for parsing source text.



## 5.1.4 The Syntactic Grammar

The *syntactic grammar* for ECMAScript is given in clauses 13 through 16. This grammar has ECMAScript tokens defined by the lexical grammar as its terminal symbols (5.1.2). It defines a set of productions, starting from two alternative *goal symbols* *Script* and *Module*, that describe how sequences of tokens form syntactically correct independent components of ECMAScript programs.

When a stream of code points is to be parsed as an ECMAScript *Script* or *Module*, it is first converted to a stream of input elements by repeated application of the lexical grammar; this stream of input elements is then parsed by a single application of the syntactic grammar. The input stream is syntactically in error if the tokens in the stream of input elements cannot be parsed as a single instance of the goal nonterminal (*Script* or *Module*), with no tokens left over.

When a parse is successful, it constructs a *parse tree*, a rooted tree structure in which each node is a *Parse Node*. Each Parse Node is an *instance* of a symbol in the grammar; it represents a span of the source text that can be derived from that symbol. The root node of the parse tree, representing the whole of the source text, is an instance of the parse's *goal symbol*. When a Parse Node is an instance of a nonterminal, it is also an instance of some production that has that nonterminal as its left-hand side. Moreover, it has zero or more *children*, one for each symbol on the production's right-hand side: each child is a Parse Node that is an instance of the corresponding symbol.

New Parse Nodes are instantiated for each invocation of the parser and never reused between parses even of identical source text. Parse Nodes are considered *the same Parse Node* if and only if they represent the same span of source text, are instances of the same grammar symbol, and resulted from the same parser invocation.

NOTE 1 Parsing the same String multiple times will lead to different Parse Nodes. For example, consider:

```
let str = "1 + 1;";  
eval(str);  
eval(str);
```

Each call to **eval** converts the value of **str** into *ECMAScript source text* and performs an independent parse that creates its own separate tree of Parse Nodes. The trees are distinct even though each parse operates upon a source text that was derived from the same String value.

NOTE 2 Parse Nodes are specification artefacts, and implementations are not required to use an analogous data structure.

Productions of the syntactic grammar are distinguished by having just one colon “:” as punctuation.

The syntactic grammar as presented in clauses 13 through 16 is not a complete account of which token sequences are accepted as a correct ECMAScript *Script* or *Module*. Certain additional token sequences are also accepted, namely, those that would be described by the grammar if only semicolons were added to the sequence in certain places (such as before line terminator characters). Furthermore, certain token sequences that are described by the grammar are not considered acceptable if a line terminator character appears in certain “awkward” places.

In certain cases, in order to avoid ambiguities, the syntactic grammar uses generalized productions that permit token sequences that do not form a valid ECMAScript *Script* or *Module*. For example, this technique is used for object literals and object destructuring patterns. In such cases a more restrictive *supplemental grammar* is provided that further restricts the acceptable token sequences. Typically, an *early error* rule will then state that, in certain contexts, “*P* must cover an *N*”, where *P* is a Parse Node (an instance of the generalized production) and *N* is a nonterminal from the supplemental grammar. This means:

1. The sequence of tokens originally matched by *P* is parsed again using *N* as the [goal symbol](#). If *N* takes grammatical parameters, then they are set to the same values used when *P* was originally parsed.
2. If the sequence of tokens can be parsed as a single instance of *N*, with no tokens left over, then:
  1. We refer to that instance of *N* (a Parse Node, unique for a given *P*) as "the *N* that is covered by *P*".
  2. All Early Error rules for *N* and its derived productions also apply to the *N* that is covered by *P*.
3. Otherwise (if the parse fails), it is an early Syntax Error.

## 5.1.5 Grammar Notation

### 5.1.5.1 Terminal Symbols

In the ECMAScript grammars, some terminal symbols are shown in **fixed-width** font. These are to appear in a source text exactly as written. All terminal symbol code points specified in this way are to be understood as the appropriate Unicode code points from the Basic Latin block, as opposed to any similar-looking code points from other Unicode ranges. A code point in a terminal symbol cannot be expressed by a `\UnicodeEscapeSequence`.

In grammars whose terminal symbols are individual Unicode code points (i.e., the lexical, RegExp, and numeric string grammars), a contiguous run of multiple fixed-width code points appearing in a production is a simple shorthand for the same sequence of code points, written as standalone terminal symbols.

For example, the production:

```
HexIntegerLiteral :: 0x HexDigits
```

is a shorthand for:

```
HexIntegerLiteral :: 0 x HexDigits
```

In contrast, in the syntactic grammar, a contiguous run of fixed-width code points is a single terminal symbol.

Terminal symbols come in two other forms:

- In the lexical and RegExp grammars, Unicode code points without a conventional printed representation are instead shown in the form "<ABBREV>" where "ABBREV" is a mnemonic for the code point or set of code points. These forms are defined in [Unicode Format-Control Characters](#), [White Space](#), and [Line Terminators](#).
- In the syntactic grammar, certain terminal symbols (e.g. *IdentifierName* and *RegularExpressionLiteral*) are shown in italics, as they refer to the nonterminals of the same name in the lexical grammar.

### 5.1.5.2 Nonterminal Symbols and Productions

Nonterminal symbols are shown in *italic* type. The definition of a nonterminal (also called a "production") is introduced by the name of the nonterminal being defined followed by one or more colons. (The number of colons indicates to which grammar the production belongs.) One or more alternative right-hand sides for the nonterminal then follow on succeeding lines. For example, the syntactic definition:

```
WhileStatement :  
    while ( Expression ) Statement
```

states that the nonterminal *WhileStatement* represents the token **while**, followed by a left parenthesis token, followed by an *Expression*, followed by a right parenthesis token, followed by a *Statement*. The occurrences of *Expression* and *Statement* are themselves nonterminals. As another example, the syntactic definition:

*ArgumentList* :  
*AssignmentExpression*  
*ArgumentList* , *AssignmentExpression*

states that an *ArgumentList* may represent either a single *AssignmentExpression* or an *ArgumentList*, followed by a comma, followed by an *AssignmentExpression*. This definition of *ArgumentList* is recursive, that is, it is defined in terms of itself. The result is that an *ArgumentList* may contain any positive number of arguments, separated by commas, where each argument expression is an *AssignmentExpression*. Such recursive definitions of nonterminals are common.

### 5.1.5.3 Optional Symbols

The subscripted suffix “*opt*”, which may appear after a terminal or nonterminal, indicates an optional symbol. The alternative containing the optional symbol actually specifies two right-hand sides, one that omits the optional element and one that includes it. This means that:

*VariableDeclaration* :  
*BindingIdentifier* *Initializer*<sub>opt</sub>

is a convenient abbreviation for:

*VariableDeclaration* :  
*BindingIdentifier*  
*BindingIdentifier* *Initializer*

and that:

*ForStatement* :  
**for** ( *LexicalDeclaration* *Expression*<sub>opt</sub> ; *Expression*<sub>opt</sub> ) *Statement*

is a convenient abbreviation for:

*ForStatement* :  
**for** ( *LexicalDeclaration* ; *Expression*<sub>opt</sub> ) *Statement*  
**for** ( *LexicalDeclaration* *Expression* ; *Expression*<sub>opt</sub> ) *Statement*

which in turn is an abbreviation for:

*ForStatement* :  
**for** ( *LexicalDeclaration* ; ) *Statement*  
**for** ( *LexicalDeclaration* ; *Expression* ) *Statement*  
**for** ( *LexicalDeclaration* *Expression* ; ) *Statement*  
**for** ( *LexicalDeclaration* *Expression* ; *Expression* ) *Statement*

so, in this example, the nonterminal *ForStatement* actually has four alternative right-hand sides.

### 5.1.5.4 Grammatical Parameters

A production may be parameterized by a subscripted annotation of the form “[*parameters*]”, which may appear as a suffix to the nonterminal symbol defined by the production. “*parameters*” may be either a single name or a comma separated list of names. A parameterized production is shorthand for a set of productions defining all combinations of the parameter names, preceded by an underscore, appended to the parameterized nonterminal symbol. This means that:

*StatementList*<sub>[Return]</sub> :  
    *ReturnStatement*  
    *ExpressionStatement*

is a convenient abbreviation for:

*StatementList* :  
    *ReturnStatement*  
    *ExpressionStatement*

*StatementList\_Return* :  
    *ReturnStatement*  
    *ExpressionStatement*

and that:

*StatementList*<sub>[Return, In]</sub> :  
    *ReturnStatement*  
    *ExpressionStatement*

is an abbreviation for:

*StatementList* :  
    *ReturnStatement*  
    *ExpressionStatement*

*StatementList\_Return* :  
    *ReturnStatement*  
    *ExpressionStatement*

*StatementList\_In* :  
    *ReturnStatement*  
    *ExpressionStatement*

*StatementList\_Return\_In* :  
    *ReturnStatement*  
    *ExpressionStatement*

Multiple parameters produce a combinatory number of productions, not all of which are necessarily referenced in a complete grammar.

References to nonterminals on the right-hand side of a production can also be parameterized. For example:

*StatementList* :  
    *ReturnStatement*  
    *ExpressionStatement*<sub>[+In]</sub>

is equivalent to saying:

*StatementList* :  
    *ReturnStatement*  
    *ExpressionStatement\_In*

and:

*StatementList* :  
    *ReturnStatement*  
    *ExpressionStatement*<sub>[~In]</sub>

is equivalent to:

*StatementList* :  
*ReturnStatement*  
*ExpressionStatement*

A nonterminal reference may have both a parameter list and an “opt” suffix. For example:

*VariableDeclaration* :  
*BindingIdentifier Initializer* [+In] opt

is an abbreviation for:

*VariableDeclaration* :  
*BindingIdentifier*  
*BindingIdentifier Initializer\_In*

Prefixing a parameter name with “?” on a right-hand side nonterminal reference makes that parameter value dependent upon the occurrence of the parameter name on the reference to the current production's left-hand side symbol. For example:

*VariableDeclaration* [In] :  
*BindingIdentifier Initializer* [?In]

is an abbreviation for:

*VariableDeclaration* :  
*BindingIdentifier Initializer*

*VariableDeclaration\_In* :  
*BindingIdentifier Initializer\_In*

If a right-hand side alternative is prefixed with “[+parameter]” that alternative is only available if the named parameter was used in referencing the production's nonterminal symbol. If a right-hand side alternative is prefixed with “[~parameter]” that alternative is only available if the named parameter was *not* used in referencing the production's nonterminal symbol. This means that:

*StatementList* [Return] :  
[+Return] *ReturnStatement*  
*ExpressionStatement*

is an abbreviation for:

*StatementList* :  
*ExpressionStatement*

*StatementList\_Return* :  
*ReturnStatement*  
*ExpressionStatement*

and that:

*StatementList* [Return] :  
[~Return] *ReturnStatement*  
*ExpressionStatement*

is an abbreviation for:

*StatementList :*  
*ReturnStatement*  
*ExpressionStatement*

*StatementList\_Return :*  
*ExpressionStatement*

### 5.1.5.5 one of

When the words “**one of**” follow the colon(s) in a grammar definition, they signify that each of the terminal symbols on the following line or lines is an alternative definition. For example, the lexical grammar for ECMAScript contains the production:

*NonZeroDigit :: one of*  
**1 2 3 4 5 6 7 8 9**

which is merely a convenient abbreviation for:

*NonZeroDigit ::*  
**1**  
**2**  
**3**  
**4**  
**5**  
**6**  
**7**  
**8**  
**9**

### 5.1.5.6 [empty]

If the phrase “[empty]” appears as the right-hand side of a production, it indicates that the production’s right-hand side contains no terminals or nonterminals.

### 5.1.5.7 Lookahead Restrictions

If the phrase “[lookahead = *seq*]” appears in the right-hand side of a production, it indicates that the production may only be used if the token sequence *seq* is a prefix of the immediately following input token sequence. Similarly, “[lookahead  $\in$  *set*]”, where *set* is a *finite* non-empty set of token sequences, indicates that the production may only be used if some element of *set* is a prefix of the immediately following token sequence. For convenience, the set can also be written as a nonterminal, in which case it represents the set of all token sequences to which that nonterminal could expand. It is considered an editorial error if the nonterminal could expand to infinitely many distinct token sequences.

These conditions may be negated. “[lookahead  $\neq$  *seq*]” indicates that the containing production may only be used if *seq* is *not* a prefix of the immediately following input token sequence, and “[lookahead  $\notin$  *set*]” indicates that the production may only be used if *no* element of *set* is a prefix of the immediately following token sequence.

As an example, given the definitions:

*DecimalDigit :: one of*  
**0 1 2 3 4 5 6 7 8 9**

*DecimalDigits* ::  
    *DecimalDigit*  
    *DecimalDigits* *DecimalDigit*

the definition:

*LookaheadExample* ::  
    **n** [lookahead  $\notin$  { 1 , 3 , 5 , 7 , 9 }] *DecimalDigits*  
    *DecimalDigit* [lookahead  $\notin$  *DecimalDigit*]

matches either the letter **n** followed by one or more decimal digits the first of which is even, or a decimal digit not followed by another decimal digit.

Note that when these phrases are used in the syntactic grammar, it may not be possible to unambiguously identify the immediately following token sequence because determining later tokens requires knowing which lexical [goal symbol](#) to use at later positions. As such, when these are used in the syntactic grammar, it is considered an editorial error for a token sequence [seq](#) to appear in a lookahead restriction (including as part of a set of sequences) if the choices of lexical [goal symbols](#) to use could change whether or not [seq](#) would be a prefix of the resulting token sequence.

#### 5.1.5.8 [no *LineTerminator* here]

If the phrase “[no *LineTerminator* here]” appears in the right-hand side of a production of the syntactic grammar, it indicates that the production is a *restricted production*: it may not be used if a *LineTerminator* occurs in the input stream at the indicated position. For example, the production:

*ThrowStatement* :  
    **throw** [no *LineTerminator* here] *Expression* ;

indicates that the production may not be used if a *LineTerminator* occurs in the script between the **throw** token and the *Expression*.

Unless the presence of a *LineTerminator* is forbidden by a restricted production, any number of occurrences of *LineTerminator* may appear between any two consecutive tokens in the stream of input elements without affecting the syntactic acceptability of the script.

#### 5.1.5.9 but not

The right-hand side of a production may specify that certain expansions are not permitted by using the phrase “**but not**” and then indicating the expansions to be excluded. For example, the production:

*Identifier* ::  
    *IdentifierName* but not *ReservedWord*

means that the nonterminal *Identifier* may be replaced by any sequence of code points that could replace *IdentifierName* provided that the same sequence of code points could not replace *ReservedWord*.

#### 5.1.5.10 Descriptive Phrases

Finally, a few nonterminal symbols are described by a descriptive phrase in sans-serif type in cases where it would be impractical to list all the alternatives:

*SourceCharacter* ::  
    any Unicode code point

## 5.2 Algorithm Conventions

The specification often uses a numbered list to specify steps in an algorithm. These algorithms are used to precisely specify the required semantics of ECMAScript language constructs. The algorithms are not intended to imply the use of any specific implementation technique. In practice, there may be more efficient algorithms available to implement a given feature.

Algorithms may be explicitly parameterized with an ordered, comma-separated sequence of alias names which may be used within the algorithm steps to reference the argument passed in that position. Optional parameters are denoted with surrounding brackets ([ , *name* ]) and are no different from required parameters within algorithm steps. A rest parameter may appear at the end of a parameter list, denoted with leading ellipsis ( , ...*name* ). The rest parameter captures all of the arguments provided following the required and optional parameters into a [List](#). If there are no such additional arguments, that [List](#) is empty.

Algorithm steps may be subdivided into sequential substeps. Substeps are indented and may themselves be further divided into indented substeps. Outline numbering conventions are used to identify substeps with the first level of substeps labelled with lowercase alphabetic characters and the second level of substeps labelled with lowercase roman numerals. If more than three levels are required these rules repeat with the fourth level using numeric labels. For example:

1. Top-level step
  - a. Substep.
    - b. Substep.
      - i. Subsubstep.
        1. Subsubsubstep
          - a. Subsubsubsubstep
            - i. Subsubsubsubsubstep

A step or substep may be written as an “if” predicate that conditions its substeps. In this case, the substeps are only applied if the predicate is true. If a step or substep begins with the word “else”, it is a predicate that is the negation of the preceding “if” predicate step at the same level.

A step may specify the iterative application of its substeps.

A step that begins with “Assert:” asserts an invariant condition of its algorithm. Such assertions are used to make explicit algorithmic invariants that would otherwise be implicit. Such assertions add no additional semantic requirements and hence need not be checked by an implementation. They are used simply to clarify algorithms.

Algorithm steps may declare named aliases for any value using the form “Let *x* be *someValue*”. These aliases are reference-like in that both *x* and *someValue* refer to the same underlying data and modifications to either are visible to both. Algorithm steps that want to avoid this reference-like behaviour should explicitly make a copy of the right-hand side: “Let *x* be a copy of *someValue*” creates a shallow copy of *someValue*.

Once declared, an alias may be referenced in any subsequent steps and must not be referenced from steps prior to the alias's declaration. Aliases may be modified using the form “Set *x* to *someOtherValue*”.

### 5.2.1 Abstract Operations

In order to facilitate their use in multiple parts of this specification, some algorithms, called *abstract operations*, are named and written in parameterized functional form so that they may be referenced by name from within other algorithms. Abstract operations are typically referenced using a functional application style such as `OperationName(arg1, arg2)`. Some abstract operations are treated as polymorphically dispatched methods of class-like specification abstractions. Such method-like abstract operations are typically referenced using a method application style such as `someValue.OperationName(arg1, arg2)`.



## 5.2.2 Syntax-Directed Operations

A *syntax-directed operation* is a named operation whose definition consists of algorithms, each of which is associated with one or more productions from one of the ECMAScript grammars. A production that has multiple alternative definitions will typically have a distinct algorithm for each alternative. When an algorithm is associated with a grammar production, it may reference the terminal and nonterminal symbols of the production alternative as if they were parameters of the algorithm. When used in this manner, nonterminal symbols refer to the actual alternative definition that is matched when parsing the source text. The *source text matched* by a grammar production or [Parse Node](#) derived from it is the portion of the source text that starts at the beginning of the first terminal that participated in the match and ends at the end of the last terminal that participated in the match.

When an algorithm is associated with a production alternative, the alternative is typically shown without any “[ ]” grammar annotations. Such annotations should only affect the syntactic recognition of the alternative and have no effect on the associated semantics for the alternative.

Syntax-directed operations are invoked with a parse node and, optionally, other parameters by using the conventions on steps 1, 3, and 4 in the following algorithm:

1. Let *status* be `SyntaxDirectedOperation` of *SomeNonTerminal*.
2. Let *someParseNode* be the parse of some source text.
3. Perform `SyntaxDirectedOperation` of *someParseNode*.
4. Perform `SyntaxDirectedOperation` of *someParseNode* with argument **"value"**.

Unless explicitly specified otherwise, all [chain productions](#) have an implicit definition for every operation that might be applied to that production's left-hand side nonterminal. The implicit definition simply reapplies the same operation with the same parameters, if any, to the [chain production](#)'s sole right-hand side nonterminal and then returns the result. For example, assume that some algorithm has a step of the form: “Return [Evaluation](#) of *Block*” and that there is a production:

*Block* :  
    { *StatementList* }

but the [Evaluation](#) operation does not associate an algorithm with that production. In that case, the [Evaluation](#) operation implicitly includes an association of the form:

### Runtime Semantics: [Evaluation](#)

*Block* : { *StatementList* }

1. Return [Evaluation](#) of *StatementList*.

## 5.2.3 Runtime Semantics

Algorithms which specify semantics that must be called at runtime are called *runtime semantics*. Runtime semantics are defined by [abstract operations](#) or [syntax-directed operations](#).

### 5.2.3.1 Completion ( [completionRecord](#) )

The abstract operation `Completion` takes argument [completionRecord](#) (a [Completion Record](#)) and returns a [Completion Record](#). It is used to emphasize that a [Completion Record](#) is being returned. It performs the following steps when called:

1. **Assert**: [completionRecord](#) is a [Completion Record](#).
2. Return [completionRecord](#).

### 5.2.3.2 Throw an Exception

Algorithms steps that say to throw an exception, such as

1. Throw a **TypeError** exception.

mean the same things as:

1. Return `ThrowCompletion`(a newly created **TypeError** object).

### 5.2.3.3 ReturnIfAbrupt

Algorithms steps that say or are otherwise equivalent to:

1. `ReturnIfAbrupt(argument)`.

mean the same thing as:

1. **Assert**: *argument* is a `Completion Record`.
2. If *argument* is an `abrupt completion`, return `Completion(argument)`.
3. Else, set *argument* to *argument*.[[Value]].

Algorithms steps that say or are otherwise equivalent to:

1. `ReturnIfAbrupt(AbstractOperation())`.

mean the same thing as:

1. Let *hygienicTemp* be `AbstractOperation()`.
2. **Assert**: *hygienicTemp* is a `Completion Record`.
3. If *hygienicTemp* is an `abrupt completion`, return `Completion(hygienicTemp)`.
4. Else, set *hygienicTemp* to *hygienicTemp*.[[Value]].

Where *hygienicTemp* is ephemeral and visible only in the steps pertaining to `ReturnIfAbrupt`.

Algorithms steps that say or are otherwise equivalent to:

1. Let *result* be `AbstractOperation(ReturnIfAbrupt(argument))`.

mean the same thing as:

1. **Assert**: *argument* is a `Completion Record`.
2. If *argument* is an `abrupt completion`, return `Completion(argument)`.
3. Else, set *argument* to *argument*.[[Value]].
4. Let *result* be `AbstractOperation(argument)`.

### 5.2.3.4 ReturnIfAbrupt Shorthands

Invocations of `abstract operations` and `syntax-directed operations` that are prefixed by `?` indicate that `ReturnIfAbrupt` should be applied to the resulting `Completion Record`. For example, the step:

1. `? OperationName()`.

is equivalent to the following step:

1. `ReturnIfAbrupt(OperationName())`.

Similarly, for method application style, the step:

1. ? `someValue.OperationName()`.

is equivalent to:

1. `ReturnIfAbrupt(someValue.OperationName())`.

Similarly, prefix `!` is used to indicate that the following invocation of an abstract or [syntax-directed operation](#) will never return an [abrupt completion](#) and that the resulting [Completion Record](#)'s `[[Value]]` field should be used in place of the return value of the operation. For example, the step:

1. Let `val` be `! OperationName()`.

is equivalent to the following steps:

1. Let `val` be `OperationName()`.
2. `Assert`: `val` is a [normal completion](#).
3. Set `val` to `val.[[Value]]`.

[Syntax-directed operations](#) for [runtime semantics](#) make use of this shorthand by placing `!` or `?` before the invocation of the operation:

1. Perform `! SyntaxDirectedOperation` of *NonTerminal*.

### 5.2.3.5 Implicit Normal Completion

In algorithms within [abstract operations](#) which are declared to return a [Completion Record](#), and within all built-in functions, the returned value is first passed to [NormalCompletion](#), and the result is used instead. This rule does not apply within the [Completion](#) algorithm or when the value being returned is clearly marked as a [Completion Record](#) in that step; these cases are:

- when the result of applying [Completion](#), [NormalCompletion](#), or [ThrowCompletion](#) is directly returned
- when the result of constructing a [Completion Record](#) is directly returned

It is an editorial error if a [Completion Record](#) is returned from such an abstract operation through any other means. For example, within these [abstract operations](#),

1. Return `true`.

means the same things as any of

1. Return `NormalCompletion(true)`.

or

1. Let `completion` be `NormalCompletion(true)`.
2. Return `Completion(completion)`.

or

1. Return [Completion Record](#) { `[[Type]]`: `normal`, `[[Value]]`: `true`, `[[Target]]`: `empty` }.

Note that, through the [ReturnIfAbrupt](#) expansion, the following example is allowed, as within the expanded steps, the result of applying [Completion](#) is returned directly in the abrupt case and the implicit

[NormalCompletion](#) application occurs after unwrapping in the normal case.

1. Return ? [completion](#).

The following example would be an editorial error because a [Completion Record](#) is being returned without being annotated in that step.

1. Let [completion](#) be [NormalCompletion\(true\)](#).
2. Return [completion](#).

## 5.2.4 Static Semantics

Context-free grammars are not sufficiently powerful to express all the rules that define whether a stream of input elements form a valid ECMAScript *Script* or *Module* that may be evaluated. In some situations additional rules are needed that may be expressed using either ECMAScript algorithm conventions or prose requirements. Such rules are always associated with a production of a grammar and are called the *static semantics* of the production.

Static Semantic Rules have names and typically are defined using an algorithm. Named Static Semantic Rules are associated with grammar productions and a production that has multiple alternative definitions will typically have for each alternative a distinct algorithm for each applicable named static semantic rule.

A special kind of static semantic rule is an *Early Error Rule*. [Early error](#) rules define [early error](#) conditions (see clause 17) that are associated with specific grammar productions. [Evaluation](#) of most [early error](#) rules are not explicitly invoked within the algorithms of this specification. A conforming implementation must, prior to the first evaluation of a *Script* or *Module*, validate all of the [early error](#) rules of the productions used to parse that *Script* or *Module*. If any of the [early error](#) rules are violated the *Script* or *Module* is invalid and cannot be evaluated.

## 5.2.5 Mathematical Operations

This specification makes reference to these kinds of numeric values:

- *Mathematical values*: Arbitrary real numbers, used as the default numeric type.
- *Extended mathematical values*: [Mathematical values](#) together with  $+\infty$  and  $-\infty$ .
- *Numbers*: [IEEE 754-2019](#) double-precision floating point values.
- *BigInts*: [ECMAScript language values](#) representing arbitrary [integers](#) in a one-to-one correspondence.

In the language of this specification, numerical values are distinguished among different numeric kinds using subscript suffixes. The subscript  $\mathbb{F}$  refers to Numbers, and the subscript  $\mathbb{Z}$  refers to BigInts. Numeric values without a subscript suffix refer to [mathematical values](#).

Numeric operators such as  $+$ ,  $\times$ ,  $=$ , and  $\geq$  refer to those operations as determined by the type of the operands. When applied to [mathematical values](#), the operators refer to the usual mathematical operations. When applied to [extended mathematical values](#), the operators refer to the usual mathematical operations over the extended real numbers; indeterminate forms are not defined and their use in this specification should be considered an editorial error. When applied to Numbers, the operators refer to the relevant operations within [IEEE 754-2019](#). When applied to BigInts, the operators refer to the usual mathematical operations applied to the [mathematical value](#) of the BigInt.

In general, when this specification refers to a numerical value, such as in the phrase, "the length of  $y$ " or "the [integer](#) represented by the four hexadecimal digits ...", without explicitly specifying a numeric kind, the phrase refers to a [mathematical value](#). Phrases which refer to a Number or a BigInt value are explicitly annotated as such; for example, "the [Number value](#) for the number of code points in ..." or "the [BigInt value](#) for ...".

Numeric operators applied to mixed-type operands (such as a Number and a [mathematical value](#)) are not defined and should be considered an editorial error in this specification.

This specification denotes most numeric values in base 10; it also uses numeric values of the form 0x followed by digits 0-9 or A-F as base-16 values.

When the term *integer* is used in this specification, it refers to a [mathematical value](#) which is in the set of [integers](#), unless otherwise stated. When the term *integral Number* is used in this specification, it refers to a Number value whose [mathematical value](#) is in the set of [integers](#).

Conversions between [mathematical values](#) and Numbers or BigInts are always explicit in this document. A conversion from a [mathematical value](#) or [extended mathematical value](#)  $x$  to a Number is denoted as "the [Number value for  \$x\$](#) " or  $\mathbb{F}(x)$ , and is defined in 6.1.6.1. A conversion from an [integer](#)  $x$  to a BigInt is denoted as "the [BigInt value for  \$x\$](#) " or  $\mathbb{Z}(x)$ . A conversion from a Number or BigInt  $x$  to a [mathematical value](#) is denoted as "the [mathematical value of  \$x\$](#) ", or  $\mathbb{R}(x)$ . The [mathematical value of  \$+0\_{\mathbb{F}}\$](#)  and  $-0_{\mathbb{F}}$  is the [mathematical value 0](#). The [mathematical value of non-finite values](#) is not defined. The [extended mathematical value of  \$x\$](#)  is the [mathematical value of  \$x\$](#)  for [finite values](#), and is  $+\infty$  and  $-\infty$  for  $+\infty_{\mathbb{F}}$  and  $-\infty_{\mathbb{F}}$  respectively; it is not defined for **NaN**.

The mathematical function  $\text{abs}(x)$  produces the absolute value of  $x$ , which is  $-x$  if  $x < 0$  and otherwise is  $x$  itself.

The mathematical function  $\text{min}(x_1, x_2, \dots, x_N)$  produces the mathematically smallest of  $x_1$  through  $x_N$ . The mathematical function  $\text{max}(x_1, x_2, \dots, x_N)$  produces the mathematically largest of  $x_1$  through  $x_N$ . The domain and range of these mathematical functions are the [extended mathematical values](#).

The notation " $x$  modulo  $y$ " ( $y$  must be [finite](#) and non-zero) computes a value  $k$  of the same sign as  $y$  (or zero) such that  $\text{abs}(k) < \text{abs}(y)$  and  $x - k = q \times y$  for some [integer](#)  $q$ .

The phrase "the result of *clamping*  $x$  between *lower* and *upper*" (where  $x$  is an [extended mathematical value](#) and *lower* and *upper* are [mathematical values](#) such that  $\text{lower} \leq \text{upper}$ ) produces *lower* if  $x < \text{lower}$ , produces *upper* if  $x > \text{upper}$ , and otherwise produces  $x$ .

The mathematical function  $\text{floor}(x)$  produces the largest [integer](#) (closest to  $+\infty$ ) that is not larger than  $x$ .

The mathematical function  $\text{truncate}(x)$  removes the fractional part of  $x$  by rounding towards zero, producing  $-\text{floor}(-x)$  if  $x < 0$  and otherwise producing  $\text{floor}(x)$ .

Mathematical functions [min](#), [max](#), [abs](#), [floor](#), and [truncate](#) are not defined for Numbers and BigInts, and any usage of those methods that have non-[mathematical value](#) arguments would be an editorial error in this specification.

NOTE  $\text{floor}(x) = x - (x \text{ modulo } 1)$ .

An *interval* from lower bound  $a$  to upper bound  $b$  is a possibly-infinite, possibly-empty set of numeric values of the same numeric type. Each bound will be described as either inclusive or exclusive, but not both. There are four kinds of intervals, as follows:

- An [interval](#) from  $a$  (inclusive) to  $b$  (inclusive), also called an *inclusive interval* from  $a$  to  $b$ , includes all values  $x$  of the same numeric type such that  $a \leq x \leq b$ , and no others.
- An [interval](#) from  $a$  (inclusive) to  $b$  (exclusive) includes all values  $x$  of the same numeric type such that  $a \leq x < b$ , and no others.
- An [interval](#) from  $a$  (exclusive) to  $b$  (inclusive) includes all values  $x$  of the same numeric type such that  $a < x \leq b$ , and no others.
- An [interval](#) from  $a$  (exclusive) to  $b$  (exclusive) includes all values  $x$  of the same numeric type such that  $a < x < b$ , and no others.

For example, the [interval](#) from 1 (inclusive) to 2 (exclusive) consists of all [mathematical values](#) between 1 and 2, including 1 and not including 2. For the purpose of defining intervals,  $-0_{\mathbb{F}} < +0_{\mathbb{F}}$ , so, for example, an [inclusive interval](#) with a lower bound of  $+0_{\mathbb{F}}$  includes  $+0_{\mathbb{F}}$  but not  $-0_{\mathbb{F}}$ . **NaN** is never included in an [interval](#).

## 5.2.6 Value Notation

In this specification, [ECMAScript language values](#) are displayed in **bold**. Examples include **null**, **true**, or **"hello"**. These are distinguished from [ECMAScript source text](#) such as **Function.prototype.apply** or **let n = 42;**.

## 5.2.7 Identity

In this specification, both specification values and [ECMAScript language values](#) are compared for equality. When comparing for equality, values fall into one of two categories. *Values without identity* are equal to other values without identity if all of their innate characteristics are the same — characteristics such as the magnitude of an [integer](#) or the length of a sequence. Values without identity may be manifest without prior reference by fully describing their characteristics. In contrast, each *value with identity* is unique and therefore only equal to itself. Values with identity are like values without identity but with an additional unguessable, unchangeable, universally-unique characteristic called *identity*. References to existing values with identity cannot be manifest simply by describing them, as the identity itself is indescribable; instead, references to these values must be explicitly passed from one place to another. Some values with identity are mutable and therefore can have their characteristics (except their identity) changed in-place, causing all holders of the value to observe the new characteristics. A value without identity is never equal to a value with identity.

From the perspective of this specification, the word “is” is used to compare two values for equality, as in “If [bool](#) is **true**, then ...”, and the word “contains” is used to search for a value inside lists using equality comparisons, as in “If [list](#) contains a [Record](#) *r* such that *r*.[[Foo]] is **true**, then ...”. The *specification identity* of values determines the result of these comparisons and is axiomatic in this specification.

From the perspective of the ECMAScript language, language values are compared for equality using the [SameValue](#) abstract operation and the [abstract operations](#) it transitively calls. The algorithms of these comparison [abstract operations](#) determine *language identity* of [ECMAScript language values](#).

For specification values, examples of values without specification identity include, but are not limited to: [mathematical values](#) and [extended mathematical values](#); [ECMAScript source text](#), [surrogate pairs](#), [Directive Prologues](#), etc; UTF-16 code units; Unicode code points; [enums](#); [abstract operations](#), including [syntax-directed operations](#), [host hooks](#), etc; and ordered pairs. Examples of specification values with specification identity include, but are not limited to: any kind of [Records](#), including [Property Descriptors](#), [PrivateElements](#), etc; [Parse Nodes](#); [Lists](#); [Sets](#) and [Relations](#); [Abstract Closures](#); [Data Blocks](#); [Private Names](#); [execution contexts](#) and [execution context stacks](#); [agent signifiers](#); and [WaiterLists](#).

Specification identity agrees with language identity for all [ECMAScript language values](#) except Symbol values produced by [Symbol.for](#). The [ECMAScript language values](#) without specification identity and without language identity are **undefined**, **null**, [Booleans](#), [Strings](#), [Numbers](#), and [BigInts](#). The [ECMAScript language values](#) with specification identity and language identity are [Symbols](#) not produced by [Symbol.for](#) and [Objects](#). Symbol values produced by [Symbol.for](#) have specification identity, but not language identity.

## 6 ECMAScript Data Types and Values

Algorithms within this specification manipulate values each of which has an associated type. The possible value types are exactly those defined in this clause. Types are further subclassified into [ECMAScript language types](#) and specification types.

Within this specification, the notation “Type(*x*)” is used as shorthand for “the *type* of *x*” where “type” refers to the ECMAScript language and specification types defined in this clause.

## 6.1 ECMAScript Language Types

An *ECMAScript language type* corresponds to values that are directly manipulated by an ECMAScript programmer using the ECMAScript language. The ECMAScript language types are Undefined, Null, Boolean, String, Symbol, Number, BigInt, and Object. An *ECMAScript language value* is a value that is characterized by an ECMAScript language type.

### 6.1.1 The Undefined Type

The Undefined type has exactly one value, called **undefined**. Any variable that has not been assigned a value has the value **undefined**.

### 6.1.2 The Null Type

The Null type has exactly one value, called **null**.

### 6.1.3 The Boolean Type

The *Boolean type* represents a logical entity having two values, called **true** and **false**.

### 6.1.4 The String Type

The *String type* is the set of all ordered sequences of zero or more 16-bit unsigned [integer](#) values (“elements”) up to a maximum length of  $2^{53} - 1$  elements. The String type is generally used to represent textual data in a running ECMAScript program, in which case each element in the String is treated as a UTF-16 code unit value. Each element is regarded as occupying a position within the sequence. These positions are indexed with non-negative [integers](#). The first element (if any) is at index 0, the next element (if any) at index 1, and so on. The length of a String is the number of elements (i.e., 16-bit values) within it. The empty String has length zero and therefore contains no elements.

ECMAScript operations that do not interpret String contents apply no further semantics. Operations that do interpret String values treat each element as a single UTF-16 code unit. However, ECMAScript does not restrict the value of or relationships between these code units, so operations that further interpret String contents as sequences of Unicode code points encoded in UTF-16 must account for ill-formed subsequences. Such operations apply special treatment to every code unit with a numeric value in the [inclusive interval](#) from 0xD800 to 0xDBFF (defined by the Unicode Standard as a *leading surrogate*, or more formally as a *high-surrogate code unit*) and every code unit with a numeric value in the [inclusive interval](#) from 0xDC00 to 0xDFFF (defined as a *trailing surrogate*, or more formally as a *low-surrogate code unit*) using the following rules:

- A code unit that is not a [leading surrogate](#) and not a [trailing surrogate](#) is interpreted as a code point with the same value.
- A sequence of two code units, where the first code unit *c1* is a [leading surrogate](#) and the second code unit *c2* a [trailing surrogate](#), is a *surrogate pair* and is interpreted as a code point with the value  $(c1 - 0xD800) \times 0x400 + (c2 - 0xDC00) + 0x10000$ . (See [11.1.3](#))
- A code unit that is a [leading surrogate](#) or [trailing surrogate](#), but is not part of a [surrogate pair](#), is interpreted as a code point with the same value.

The function **String.prototype.normalize** (see [22.1.3.14](#)) can be used to explicitly normalize a String value. **String.prototype.localeCompare** (see [22.1.3.11](#)) internally normalizes String values, but no other operations implicitly normalize the strings upon which they operate. Operation results are not language- and/or locale-sensitive unless stated otherwise.

**NOTE** The rationale behind this design was to keep the implementation of Strings as simple and high-performing as possible. If *ECMAScript source text* is in Normalized Form C, string literals are guaranteed to also be normalized, as long as they do not contain any Unicode escape sequences.

In this specification, the phrase "the *string-concatenation* of *A, B, ...*" (where each argument is a String value, a code unit, or a sequence of code units) denotes the String value whose sequence of code units is the concatenation of the code units (in order) of each of the arguments (in order).

The phrase "the *substring* of *S* from *inclusiveStart* to *exclusiveEnd*" (where *S* is a String value or a sequence of code units and *inclusiveStart* and *exclusiveEnd* are *integers*) denotes the String value consisting of the consecutive code units of *S* beginning at index *inclusiveStart* and ending immediately before index *exclusiveEnd* (which is the empty String when *inclusiveStart* = *exclusiveEnd*). If the "to" suffix is omitted, the length of *S* is used as the value of *exclusiveEnd*.

The phrase "the *ASCII word characters*" denotes the following String value, which consists solely of every letter and number in the Unicode Basic Latin block along with U+005F (LOW LINE):

**"ABCDEFGHIJKLMNOPQRSTUVWXYZabcdefghijklmnopqrstuvwxyz0123456789\_".**

For historical reasons, it has significance to various algorithms.

#### 6.1.4.1 *StringIndexOf* ( *string*, *searchValue*, *fromIndex* )

The abstract operation *StringIndexOf* takes arguments *string* (a String), *searchValue* (a String), and *fromIndex* (a non-negative *integer*) and returns an *integer*. It performs the following steps when called:

1. Let *len* be the length of *string*.
2. If *searchValue* is the empty String and  $fromIndex \leq len$ , return *fromIndex*.
3. Let *searchLen* be the length of *searchValue*.
4. For each *integer* *i* such that  $fromIndex \leq i \leq len - searchLen$ , in ascending order, do
  - a. Let *candidate* be the *substring* of *string* from *i* to *i* + *searchLen*.
  - b. If *candidate* is *searchValue*, return *i*.
5. Return -1.

**NOTE 1** If *searchValue* is the empty String and  $fromIndex \leq$  the length of *string*, this algorithm returns *fromIndex*. The empty String is effectively found at every position within a string, including after the last code unit.

**NOTE 2** This algorithm always returns -1 if  $fromIndex +$  the length of *searchValue* > the length of *string*.

### 6.1.5 The Symbol Type

The *Symbol type* is the set of all non-String values that may be used as the key of an Object property (6.1.7).

Each possible Symbol value is unique and immutable.

Each Symbol value immutably holds an associated value called [[Description]] that is either **undefined** or a String value.

#### 6.1.5.1 Well-Known Symbols

Well-known symbols are built-in Symbol values that are explicitly referenced by algorithms of this specification. They are typically used as the keys of properties whose values serve as extension points of a



specification algorithm. Unless otherwise specified, well-known symbols values are shared by all [realms](#) (9.3).

Within this specification a well-known symbol is referred to by using a notation of the form @@name, where “name” is one of the values listed in [Table 1](#).

Table 1: Well-known Symbols

Specification Name	[[Description]]	Value and Purpose
<a href="#">@@asyncIterator</a>	"Symbol.asyncIterator"	A method that returns the default AsyncIterator for an object. Called by the semantics of the <b>for-await-of</b> statement.
<a href="#">@@hasInstance</a>	"Symbol.hasInstance"	A method that determines if a <a href="#">constructor</a> object recognizes an object as one of the <a href="#">constructor</a> 's instances. Called by the semantics of the <b>instanceof</b> operator.
<a href="#">@@isConcatSpreadable</a>	"Symbol.isConcatSpreadable"	A Boolean valued property that if true indicates that an object should be flattened to its array elements by <a href="#">Array.prototype.concat</a> .
<a href="#">@@iterator</a>	"Symbol.iterator"	A method that returns the default Iterator for an object. Called by the semantics of the <b>for</b> statement.
<a href="#">@@match</a>	"Symbol.match"	A regular expression method that matches the regular expression against a string. Called by the <a href="#">String.prototype.match</a> method.
<a href="#">@@matchAll</a>	"Symbol.matchAll"	A regular expression method that returns an iterator, that yields matches of the regular expression against a string. Called by the <a href="#">String.prototype.matchAll</a> method.
<a href="#">@@replace</a>	"Symbol.replace"	A regular expression method that replaces matched substrings of a string. Called by the <a href="#">String.prototype.replace</a> method.
<a href="#">@@search</a>	"Symbol.search"	A regular expression method that returns the index within a string that matches the regular expression. Called by the <a href="#">String.prototype.search</a> method.
<a href="#">@@species</a>	"Symbol.species"	A function valued property that is the <a href="#">constructor</a> function that is used to create derived objects.
<a href="#">@@split</a>	"Symbol.split"	A regular expression method that splits a string at the indices that match the regular expression. Called by the <a href="#">String.prototype.split</a> method.
<a href="#">@@toPrimitive</a>	"Symbol.toPrimitive"	A method that converts an object to a corresponding primitive value. Called by the <a href="#">ToPrimitive</a> abstract operation.

Table 1 (continued)

Specification Name	[[Description]]	Value and Purpose
<code>@@toStringTag</code>	" <b>Symbol.toStringTag</b> "	A String valued property that is used in the creation of the default string description of an object. Accessed by the built-in method <code>Object.prototype.toString</code> .
<code>@@unscopables</code>	" <b>Symbol.unscopables</b> "	An object valued property whose own and inherited property names are property names that are excluded from the <code>with</code> environment bindings of the associated object.

## 6.1.6 Numeric Types

ECMAScript has two built-in numeric types: Number and BigInt. The following [abstract operations](#) are defined over these numeric types. The "Result" column shows the return type, along with an indication if it is possible for some invocations of the operation to return an [abrupt completion](#).

Table 2: Numeric Type Operations

Operation	Example source	Invoked by the <a href="#">Evaluation semantics</a> of ...	Result
<code>Number::unaryMinus</code>	<code>-x</code>	Unary - Operator	Number
<code>BigInt::unaryMinus</code>			BigInt
<code>Number::bitwiseNOT</code>	<code>~x</code>	Bitwise NOT Operator ( <code>~</code> )	Number
<code>BigInt::bitwiseNOT</code>			BigInt
<code>Number::exponentiate</code>	<code>x ** y</code>	Exponentiation Operator and <code>Math.pow ( base, exponent )</code>	Number
<code>BigInt::exponentiate</code>			either a <a href="#">normal completion</a> containing a BigInt or a <a href="#">throw completion</a>
<code>Number::multiply</code>	<code>x * y</code>	Multiplicative Operators	Number
<code>BigInt::multiply</code>			BigInt
<code>Number::divide</code>	<code>x / y</code>	Multiplicative Operators	Number
<code>BigInt::divide</code>			either a <a href="#">normal completion</a> containing a BigInt or a <a href="#">throw completion</a>
<code>Number::remainder</code>	<code>x % y</code>	Multiplicative Operators	Number
<code>BigInt::remainder</code>			either a <a href="#">normal completion</a> containing a BigInt or a <a href="#">throw completion</a>
<code>Number::add</code>	<code>x ++</code> <code>++ x</code> <code>x + y</code>	Postfix Increment Operator, Prefix Increment Operator, and The Addition Operator ( <code>+</code> )	Number
<code>BigInt::add</code>			BigInt
<code>Number::subtract</code>	<code>x --</code> <code>-- x</code> <code>x - y</code>	Postfix Decrement Operator, Prefix Decrement Operator, and The Subtraction Operator ( <code>-</code> )	Number
<code>BigInt::subtract</code>			BigInt

Table 2 (continued)

Operation	Example source	Invoked by the Evaluation semantics of ...	Result
Number::leftShift	x << y	The Left Shift Operator ( << )	Number
BigInt::leftShift			BigInt
Number::signedRightShift	x >> y	The Signed Right Shift Operator ( >> )	Number
BigInt::signedRightShift			BigInt
Number::unsignedRightShift	x >>> y	The Unsigned Right Shift Operator ( >>> )	Number
BigInt::unsignedRightShift			a throw completion
Number::lessThan	x < y x > y x <= y x >= y	Relational Operators, via <code>isLessThan ( x, y, LeftFirst )</code>	Boolean or <b>undefined</b> (for unordered inputs)
BigInt::lessThan			Boolean
Number::equal	x == y x != y x === y x !== y	Equality Operators, via <code>isStrictlyEqual ( x, y )</code>	Boolean
BigInt::equal			
Number::sameValue	<code>Object.is(x, y)</code>	Object internal methods, via <code>SameValue ( x, y )</code> , to test exact value equality	Boolean
Number::sameValueZero	<code>[x].includes(y)</code>	Array, Map, and Set methods, via <code>SameValueZero ( x, y )</code> , to test value equality, ignoring the difference between <code>+0<sub>F</sub></code> and <code>-0<sub>F</sub></code>	Boolean
Number::bitwiseAND	x & y	Binary Bitwise Operators	Number
BigInt::bitwiseAND			BigInt
Number::bitwiseXOR	x ^ y		Number
BigInt::bitwiseXOR			BigInt
Number::bitwiseOR	x   y		Number
BigInt::bitwiseOR			BigInt
Number::toString	<code>String(x)</code>	Many expressions and built-in functions, via <code>ToString ( argument )</code>	String
BigInt::toString			

Because the numeric types are in general not convertible without loss of precision or truncation, the ECMAScript language provides no implicit conversion among these types. Programmers must explicitly call **Number** and **BigInt** functions to convert among types when calling a function which requires another type.

**NOTE** The first and subsequent editions of ECMAScript have provided, for certain operators, implicit numeric conversions that could lose precision or [truncate](#). These legacy implicit conversions are maintained for backward compatibility, but not provided for BigInt in order to minimize opportunity for programmer error, and to leave open the option of generalized *value types* in a future edition.

### 6.1.6.1 The Number Type

The *Number type* has exactly 18,437,736,874,454,810,627 (that is,  $2^{64} - 2^{53} + 3$ ) values, representing the double-precision 64-bit format [IEEE 754-2019](#) values as specified in the IEEE Standard for Binary Floating-Point Arithmetic, except that the 9,007,199,254,740,990 (that is,  $2^{53} - 2$ ) distinct “Not-a-Number” values of the IEEE Standard are represented in ECMAScript as a single special **NaN** value. (Note that the **NaN** value is produced by the program expression **NaN**.) In some implementations, external code might be able to detect a difference between various Not-a-Number values, but such behaviour is [implementation-defined](#); to ECMAScript code, all **NaN** values are indistinguishable from each other.

**NOTE** The bit pattern that might be observed in an ArrayBuffer (see [25.1](#)) or a SharedArrayBuffer (see [25.2](#)) after a Number value has been stored into it is not necessarily the same as the internal representation of that Number value used by the ECMAScript implementation.

There are two other special values, called **positive Infinity** and **negative Infinity**. For brevity, these values are also referred to for expository purposes by the symbols  $+\infty_{\text{F}}$  and  $-\infty_{\text{F}}$ , respectively. (Note that these two infinite Number values are produced by the program expressions **+Infinity** (or simply **Infinity**) and **-Infinity**.)

The other 18,437,736,874,454,810,624 (that is,  $2^{64} - 2^{53}$ ) values are called the *finite* numbers. Half of these are positive numbers and half are negative numbers; for every *finite* positive Number value there is a corresponding negative value having the same magnitude.

Note that there is both a **positive zero** and a **negative zero**. For brevity, these values are also referred to for expository purposes by the symbols  $+0_{\text{F}}$  and  $-0_{\text{F}}$ , respectively. (Note that these two different zero Number values are produced by the program expressions **+0** (or simply **0**) and **-0**.)

The 18,437,736,874,454,810,622 (that is,  $2^{64} - 2^{53} - 2$ ) *finite* non-zero values are of two kinds:

18,428,729,675,200,069,632 (that is,  $2^{64} - 2^{54}$ ) of them are normalized, having the form

$$s \times m \times 2^e$$

where *s* is 1 or -1, *m* is an *integer* in the *interval* from  $2^{52}$  (inclusive) to  $2^{53}$  (exclusive), and *e* is an *integer* in the *inclusive interval* from -1074 to 971.

The remaining 9,007,199,254,740,990 (that is,  $2^{53} - 2$ ) values are denormalized, having the form

$$s \times m \times 2^e$$

where *s* is 1 or -1, *m* is an *integer* in the *interval* from 0 (exclusive) to  $2^{52}$  (exclusive), and *e* is -1074.

Note that all the positive and negative *integers* whose magnitude is no greater than  $2^{53}$  are representable in the Number type. The *integer* 0 has two representations in the Number type:  $+0_{\text{F}}$  and  $-0_{\text{F}}$ .

A *finite* number has an *odd significand* if it is non-zero and the *integer* *m* used to express it (in one of the two forms shown above) is odd. Otherwise, it has an *even significand*.

In this specification, the phrase “the *Number value for x*” where *x* represents an exact real mathematical quantity (which might even be an irrational number such as  $\pi$ ) means a Number value chosen in the following manner. Consider the set of all *finite* values of the Number type, with  $-0_{\mathbb{F}}$  removed and with two additional values added to it that are not representable in the Number type, namely  $2^{1024}$  (which is  $+1 \times 2^{53} \times 2^{971}$ ) and  $-2^{1024}$  (which is  $-1 \times 2^{53} \times 2^{971}$ ). Choose the member of this set that is closest in value to *x*. If two values of the set are equally close, then the one with an even significand is chosen; for this purpose, the two extra values  $2^{1024}$  and  $-2^{1024}$  are considered to have even significands. Finally, if  $2^{1024}$  was chosen, replace it with  $+\infty_{\mathbb{F}}$ ; if  $-2^{1024}$  was chosen, replace it with  $-\infty_{\mathbb{F}}$ ; if  $+0_{\mathbb{F}}$  was chosen, replace it with  $-0_{\mathbb{F}}$  if and only if *x* < 0; any other chosen value is used unchanged. The result is the *Number value for x*. (This procedure corresponds exactly to the behaviour of the IEEE 754-2019 roundTiesToEven mode.)

The *Number value for*  $+\infty$  is  $+\infty_{\mathbb{F}}$ , and the *Number value for*  $-\infty$  is  $-\infty_{\mathbb{F}}$ .

Some ECMAScript operators deal only with *integers* in specific ranges such as the *inclusive interval* from  $-2^{31}$  to  $2^{31} - 1$  or the *inclusive interval* from 0 to  $2^{16} - 1$ . These operators accept any value of the Number type but first convert each such value to an *integer* value in the expected range. See the descriptions of the numeric conversion operations in 7.1.

#### 6.1.6.1.1 Number::unaryMinus ( *x* )

The abstract operation Number::unaryMinus takes argument *x* (a Number) and returns a Number. It performs the following steps when called:

1. If *x* is **NaN**, return **NaN**.
2. Return the result of negating *x*; that is, compute a Number with the same magnitude but opposite sign.

#### 6.1.6.1.2 Number::bitwiseNOT ( *x* )

The abstract operation Number::bitwiseNOT takes argument *x* (a Number) and returns an *integral Number*. It performs the following steps when called:

1. Let *oldValue* be !ToInt32(*x*).
2. Return the result of applying bitwise complement to *oldValue*. The *mathematical value* of the result is exactly representable as a 32-bit two's complement bit string.

#### 6.1.6.1.3 Number::exponentiate ( *base*, *exponent* )

The abstract operation Number::exponentiate takes arguments *base* (a Number) and *exponent* (a Number) and returns a Number. It returns an *implementation-approximated* value representing the result of raising *base* to the *exponent* power. It performs the following steps when called:

1. If *exponent* is **NaN**, return **NaN**.
2. If *exponent* is either  $+0_{\mathbb{F}}$  or  $-0_{\mathbb{F}}$ , return  $1_{\mathbb{F}}$ .
3. If *base* is **NaN**, return **NaN**.
4. If *base* is  $+\infty_{\mathbb{F}}$ , then
  - a. If *exponent* >  $+0_{\mathbb{F}}$ , return  $+\infty_{\mathbb{F}}$ . Otherwise, return  $+0_{\mathbb{F}}$ .
5. If *base* is  $-\infty_{\mathbb{F}}$ , then
  - a. If *exponent* >  $+0_{\mathbb{F}}$ , then
    - i. If *exponent* is an odd *integral Number*, return  $-\infty_{\mathbb{F}}$ . Otherwise, return  $+\infty_{\mathbb{F}}$ .
    - b. Else,
      - i. If *exponent* is an odd *integral Number*, return  $-0_{\mathbb{F}}$ . Otherwise, return  $+0_{\mathbb{F}}$ .

6. If *base* is  $+0_{\mathbb{F}}$ , then
  - a. If *exponent*  $> +0_{\mathbb{F}}$ , return  $+0_{\mathbb{F}}$ . Otherwise, return  $+\infty_{\mathbb{F}}$ .
7. If *base* is  $-0_{\mathbb{F}}$ , then
  - a. If *exponent*  $> +0_{\mathbb{F}}$ , then
    - i. If *exponent* is an odd [integral Number](#), return  $-0_{\mathbb{F}}$ . Otherwise, return  $+0_{\mathbb{F}}$ .
  - b. Else,
    - i. If *exponent* is an odd [integral Number](#), return  $-\infty_{\mathbb{F}}$ . Otherwise, return  $+\infty_{\mathbb{F}}$ .
8. **Assert:** *base* is *finite* and is neither  $+0_{\mathbb{F}}$  nor  $-0_{\mathbb{F}}$ .
9. If *exponent* is  $+\infty_{\mathbb{F}}$ , then
  - a. If  $\text{abs}(\mathbb{R}(\textit{base})) > 1$ , return  $+\infty_{\mathbb{F}}$ .
  - b. If  $\text{abs}(\mathbb{R}(\textit{base})) = 1$ , return **NaN**.
  - c. If  $\text{abs}(\mathbb{R}(\textit{base})) < 1$ , return  $+0_{\mathbb{F}}$ .
10. If *exponent* is  $-\infty_{\mathbb{F}}$ , then
  - a. If  $\text{abs}(\mathbb{R}(\textit{base})) > 1$ , return  $+0_{\mathbb{F}}$ .
  - b. If  $\text{abs}(\mathbb{R}(\textit{base})) = 1$ , return **NaN**.
  - c. If  $\text{abs}(\mathbb{R}(\textit{base})) < 1$ , return  $+\infty_{\mathbb{F}}$ .
11. **Assert:** *exponent* is *finite* and is neither  $+0_{\mathbb{F}}$  nor  $-0_{\mathbb{F}}$ .
12. If *base*  $< -0_{\mathbb{F}}$  and *exponent* is not an [integral Number](#), return **NaN**.
13. Return an [implementation-approximated](#) Number value representing the result of raising  $\mathbb{R}(\textit{base})$  to the  $\mathbb{R}(\textit{exponent})$  power.

**NOTE** The result of *base* **\*\*** *exponent* when *base* is  $1_{\mathbb{F}}$  or  $-1_{\mathbb{F}}$  and *exponent* is  $+\infty_{\mathbb{F}}$  or  $-\infty_{\mathbb{F}}$ , or when *base* is  $1_{\mathbb{F}}$  and *exponent* is **NaN**, differs from [IEEE 754-2019](#). The first edition of ECMAScript specified a result of **NaN** for this operation, whereas later revisions of IEEE 754 specified  $1_{\mathbb{F}}$ . The historical ECMAScript behaviour is preserved for compatibility reasons.

#### 6.1.6.1.4 Number::multiply ( *x*, *y* )

The abstract operation Number::multiply takes arguments *x* (a Number) and *y* (a Number) and returns a Number. It performs multiplication according to the rules of [IEEE 754-2019](#) binary double-precision arithmetic, producing the product of *x* and *y*. It performs the following steps when called:

1. If *x* is **NaN** or *y* is **NaN**, return **NaN**.
2. If *x* is either  $+\infty_{\mathbb{F}}$  or  $-\infty_{\mathbb{F}}$ , then
  - a. If *y* is either  $+0_{\mathbb{F}}$  or  $-0_{\mathbb{F}}$ , return **NaN**.
  - b. If *y*  $> +0_{\mathbb{F}}$ , return *x*.
  - c. Return  $-x$ .
3. If *y* is either  $+\infty_{\mathbb{F}}$  or  $-\infty_{\mathbb{F}}$ , then
  - a. If *x* is either  $+0_{\mathbb{F}}$  or  $-0_{\mathbb{F}}$ , return **NaN**.
  - b. If *x*  $> +0_{\mathbb{F}}$ , return *y*.
  - c. Return  $-y$ .
4. If *x* is  $-0_{\mathbb{F}}$ , then
  - a. If *y* is  $-0_{\mathbb{F}}$  or *y*  $< -0_{\mathbb{F}}$ , return  $+0_{\mathbb{F}}$ .
  - b. Else, return  $-0_{\mathbb{F}}$ .
5. If *y* is  $-0_{\mathbb{F}}$ , then
  - a. If *x*  $< -0_{\mathbb{F}}$ , return  $+0_{\mathbb{F}}$ .

- b. Else, return  $-0_{\mathbb{F}}$ .
6. Return  $\mathbb{F}(\mathbb{R}(x) \times \mathbb{R}(y))$ .

**NOTE** *Finite-precision multiplication is commutative, but not always associative.*

#### 6.1.6.1.5 Number::divide ( *x*, *y* )

The abstract operation Number::divide takes arguments *x* (a Number) and *y* (a Number) and returns a Number. It performs division according to the rules of [IEEE 754-2019](#) binary double-precision arithmetic, producing the quotient of *x* and *y* where *x* is the dividend and *y* is the divisor. It performs the following steps when called:

1. If *x* is **NaN** or *y* is **NaN**, return **NaN**.
2. If *x* is either  $+\infty_{\mathbb{F}}$  or  $-\infty_{\mathbb{F}}$ , then
  - a. If *y* is either  $+\infty_{\mathbb{F}}$  or  $-\infty_{\mathbb{F}}$ , return **NaN**.
  - b. If *y* is  $+0_{\mathbb{F}}$  or *y*  $>$   $+0_{\mathbb{F}}$ , return *x*.
  - c. Return  $-x$ .
3. If *y* is  $+\infty_{\mathbb{F}}$ , then
  - a. If *x* is  $+0_{\mathbb{F}}$  or *x*  $>$   $+0_{\mathbb{F}}$ , return  $+0_{\mathbb{F}}$ . Otherwise, return  $-0_{\mathbb{F}}$ .
4. If *y* is  $-\infty_{\mathbb{F}}$ , then
  - a. If *x* is  $+0_{\mathbb{F}}$  or *x*  $>$   $+0_{\mathbb{F}}$ , return  $-0_{\mathbb{F}}$ . Otherwise, return  $+0_{\mathbb{F}}$ .
5. If *x* is either  $+0_{\mathbb{F}}$  or  $-0_{\mathbb{F}}$ , then
  - a. If *y* is either  $+0_{\mathbb{F}}$  or  $-0_{\mathbb{F}}$ , return **NaN**.
  - b. If *y*  $>$   $+0_{\mathbb{F}}$ , return *x*.
  - c. Return  $-x$ .
6. If *y* is  $+0_{\mathbb{F}}$ , then
  - a. If *x*  $>$   $+0_{\mathbb{F}}$ , return  $+\infty_{\mathbb{F}}$ . Otherwise, return  $-\infty_{\mathbb{F}}$ .
7. If *y* is  $-0_{\mathbb{F}}$ , then
  - a. If *x*  $>$   $+0_{\mathbb{F}}$ , return  $-\infty_{\mathbb{F}}$ . Otherwise, return  $+\infty_{\mathbb{F}}$ .
8. Return  $\mathbb{F}(\mathbb{R}(x) / \mathbb{R}(y))$ .

#### 6.1.6.1.6 Number::remainder ( *n*, *d* )

The abstract operation Number::remainder takes arguments *n* (a Number) and *d* (a Number) and returns a Number. It yields the remainder from an implied division of its operands where *n* is the dividend and *d* is the divisor. It performs the following steps when called:

1. If *n* is **NaN** or *d* is **NaN**, return **NaN**.
2. If *n* is either  $+\infty_{\mathbb{F}}$  or  $-\infty_{\mathbb{F}}$ , return **NaN**.
3. If *d* is either  $+\infty_{\mathbb{F}}$  or  $-\infty_{\mathbb{F}}$ , return *n*.
4. If *d* is either  $+0_{\mathbb{F}}$  or  $-0_{\mathbb{F}}$ , return **NaN**.
5. If *n* is either  $+0_{\mathbb{F}}$  or  $-0_{\mathbb{F}}$ , return *n*.
6. **Assert**: *n* and *d* are *finite* and non-zero.
7. Let *quotient* be  $\mathbb{R}(n) / \mathbb{R}(d)$ .
8. Let *q* be *truncate*(*quotient*).
9. Let *r* be  $\mathbb{R}(n) - (\mathbb{R}(d) \times q)$ .
10. If *r* = 0 and *n*  $<$   $-0_{\mathbb{F}}$ , return  $-0_{\mathbb{F}}$ .
11. Return  $\mathbb{F}(r)$ .

NOTE 1 In C and C++, the remainder operator accepts only integral operands; in ECMAScript, it also accepts floating-point operands.

NOTE 2 The result of a floating-point remainder operation as computed by the `%` operator is not the same as the “remainder” operation defined by IEEE 754-2019. The IEEE 754-2019 “remainder” operation computes the remainder from a rounding division, not a truncating division, and so its behaviour is not analogous to that of the usual integer remainder operator. Instead the ECMAScript language defines `%` on floating-point operations to behave in a manner analogous to that of the Java integer remainder operator; this may be compared with the C library function `fmod`.

#### 6.1.6.1.7 `Number::add ( x, y )`

The abstract operation `Number::add` takes arguments `x` (a Number) and `y` (a Number) and returns a Number. It performs addition according to the rules of IEEE 754-2019 binary double-precision arithmetic, producing the sum of its arguments. It performs the following steps when called:

1. If `x` is **NaN** or `y` is **NaN**, return **NaN**.
2. If `x` is  $+\infty_{\mathbb{F}}$  and `y` is  $-\infty_{\mathbb{F}}$ , return **NaN**.
3. If `x` is  $-\infty_{\mathbb{F}}$  and `y` is  $+\infty_{\mathbb{F}}$ , return **NaN**.
4. If `x` is either  $+\infty_{\mathbb{F}}$  or  $-\infty_{\mathbb{F}}$ , return `x`.
5. If `y` is either  $+\infty_{\mathbb{F}}$  or  $-\infty_{\mathbb{F}}$ , return `y`.
6. **Assert**: `x` and `y` are both *finite*.
7. If `x` is  $-0_{\mathbb{F}}$  and `y` is  $-0_{\mathbb{F}}$ , return  $-0_{\mathbb{F}}$ .
8. Return  $\mathbb{F}(\mathbb{R}(x) + \mathbb{R}(y))$ .

NOTE *Finite*-precision addition is commutative, but not always associative.

#### 6.1.6.1.8 `Number::subtract ( x, y )`

The abstract operation `Number::subtract` takes arguments `x` (a Number) and `y` (a Number) and returns a Number. It performs subtraction, producing the difference of its operands; `x` is the minuend and `y` is the subtrahend. It performs the following steps when called:

1. Return `Number::add(x, Number::unaryMinus(y))`.

NOTE It is always the case that `x - y` produces the same result as `x + (-y)`.

#### 6.1.6.1.9 `Number::leftShift ( x, y )`

The abstract operation `Number::leftShift` takes arguments `x` (a Number) and `y` (a Number) and returns an *integral Number*. It performs the following steps when called:

1. Let `lnum` be `!ToInt32(x)`.
2. Let `rnum` be `!ToUint32(y)`.
3. Let `shiftCount` be  $\mathbb{R}(rnum)$  modulo 32.
4. Return the result of left shifting `lnum` by `shiftCount` bits. The *mathematical value* of the result is exactly representable as a 32-bit two's complement bit string.



#### 6.1.6.1.10 Number::signedRightShift ( *x*, *y* )

The abstract operation Number::signedRightShift takes arguments *x* (a Number) and *y* (a Number) and returns an **integral Number**. It performs the following steps when called:

1. Let *inum* be ! ToInt32(*x*).
2. Let *num* be ! ToUint32(*y*).
3. Let *shiftCount* be  $\mathbb{R}(\textit{num})$  modulo 32.
4. Return the result of performing a sign-extending right shift of *inum* by *shiftCount* bits. The most significant bit is propagated. The **mathematical value** of the result is exactly representable as a 32-bit two's complement bit string.

#### 6.1.6.1.11 Number::unsignedRightShift ( *x*, *y* )

The abstract operation Number::unsignedRightShift takes arguments *x* (a Number) and *y* (a Number) and returns an **integral Number**. It performs the following steps when called:

1. Let *inum* be ! ToUint32(*x*).
2. Let *num* be ! ToUint32(*y*).
3. Let *shiftCount* be  $\mathbb{R}(\textit{num})$  modulo 32.
4. Return the result of performing a zero-filling right shift of *inum* by *shiftCount* bits. Vacated bits are filled with zero. The **mathematical value** of the result is exactly representable as a 32-bit unsigned bit string.

#### 6.1.6.1.12 Number::lessThan ( *x*, *y* )

The abstract operation Number::lessThan takes arguments *x* (a Number) and *y* (a Number) and returns a Boolean or **undefined**. It performs the following steps when called:

1. If *x* is **NaN**, return **undefined**.
2. If *y* is **NaN**, return **undefined**.
3. If *x* is *y*, return **false**.
4. If *x* is  $+0_{\mathbb{F}}$  and *y* is  $-0_{\mathbb{F}}$ , return **false**.
5. If *x* is  $-0_{\mathbb{F}}$  and *y* is  $+0_{\mathbb{F}}$ , return **false**.
6. If *x* is  $+\infty_{\mathbb{F}}$ , return **false**.
7. If *y* is  $+\infty_{\mathbb{F}}$ , return **true**.
8. If *y* is  $-\infty_{\mathbb{F}}$ , return **false**.
9. If *x* is  $-\infty_{\mathbb{F}}$ , return **true**.
10. **Assert**: *x* and *y* are **finite** and non-zero.
11. If  $\mathbb{R}(x) < \mathbb{R}(y)$ , return **true**. Otherwise, return **false**.

#### 6.1.6.1.13 Number::equal ( *x*, *y* )

The abstract operation Number::equal takes arguments *x* (a Number) and *y* (a Number) and returns a Boolean. It performs the following steps when called:

1. If *x* is **NaN**, return **false**.
2. If *y* is **NaN**, return **false**.
3. If *x* is *y*, return **true**.
4. If *x* is  $+0_{\mathbb{F}}$  and *y* is  $-0_{\mathbb{F}}$ , return **true**.
5. If *x* is  $-0_{\mathbb{F}}$  and *y* is  $+0_{\mathbb{F}}$ , return **true**.

6. Return **false**.

#### 6.1.6.1.14 Number::sameValue ( *x*, *y* )

The abstract operation Number::sameValue takes arguments *x* (a Number) and *y* (a Number) and returns a Boolean. It performs the following steps when called:

1. If *x* is **NaN** and *y* is **NaN**, return **true**.
2. If *x* is **+0<sub>F</sub>** and *y* is **-0<sub>F</sub>**, return **false**.
3. If *x* is **-0<sub>F</sub>** and *y* is **+0<sub>F</sub>**, return **false**.
4. If *x* is *y*, return **true**.
5. Return **false**.

#### 6.1.6.1.15 Number::sameValueZero ( *x*, *y* )

The abstract operation Number::sameValueZero takes arguments *x* (a Number) and *y* (a Number) and returns a Boolean. It performs the following steps when called:

1. If *x* is **NaN** and *y* is **NaN**, return **true**.
2. If *x* is **+0<sub>F</sub>** and *y* is **-0<sub>F</sub>**, return **true**.
3. If *x* is **-0<sub>F</sub>** and *y* is **+0<sub>F</sub>**, return **true**.
4. If *x* is *y*, return **true**.
5. Return **false**.

#### 6.1.6.1.16 NumberBitwiseOp ( *op*, *x*, *y* )

The abstract operation NumberBitwiseOp takes arguments *op* (**&**, **^**, or **|**), *x* (a Number), and *y* (a Number) and returns an **integral Number**. It performs the following steps when called:

1. Let *inum* be ! ToInt32(*x*).
2. Let *rnum* be ! ToInt32(*y*).
3. Let *lbits* be the 32-bit two's complement bit string representing  $\mathbb{R}(\textit{inum})$ .
4. Let *rbits* be the 32-bit two's complement bit string representing  $\mathbb{R}(\textit{rnum})$ .
5. If *op* is **&**, let *result* be the result of applying the bitwise AND operation to *lbits* and *rbits*.
6. Else if *op* is **^**, let *result* be the result of applying the bitwise exclusive OR (XOR) operation to *lbits* and *rbits*.
7. Else, *op* is **|**. Let *result* be the result of applying the bitwise inclusive OR operation to *lbits* and *rbits*.
8. Return the **Number value** for the **integer** represented by the 32-bit two's complement bit string *result*.

#### 6.1.6.1.17 Number::bitwiseAND ( *x*, *y* )

The abstract operation Number::bitwiseAND takes arguments *x* (a Number) and *y* (a Number) and returns an **integral Number**. It performs the following steps when called:

1. Return NumberBitwiseOp(**&**, *x*, *y*).

#### 6.1.6.1.18 Number::bitwiseXOR ( *x*, *y* )

The abstract operation Number::bitwiseXOR takes arguments *x* (a Number) and *y* (a Number) and returns an **integral Number**. It performs the following steps when called:

1. Return NumberBitwiseOp(**^**, *x*, *y*).

### 6.1.6.1.19 Number::bitwiseOR ( *x*, *y* )

The abstract operation Number::bitwiseOR takes arguments *x* (a Number) and *y* (a Number) and returns an [integral Number](#). It performs the following steps when called:

1. Return [NumberBitwiseOp](#)( |, *x*, *y* ).

### 6.1.6.1.20 Number::toString ( *x*, *radix* )

The abstract operation Number::toString takes arguments *x* (a Number) and *radix* (an [integer](#) in the [inclusive interval](#) from 2 to 36) and returns a String. It represents *x* as a String using a positional numeral system with radix *radix*. The digits used in the representation of a number using radix *r* are taken from the first *r* code units of "0123456789abcdefghijklmnopqrstuvwxyz" in order. The representation of numbers with magnitude greater than or equal to  $1_{\mathbb{F}}$  never includes leading zeroes. It performs the following steps when called:

1. If *x* is NaN, return "NaN".
2. If *x* is either  $+0_{\mathbb{F}}$  or  $-0_{\mathbb{F}}$ , return "0".
3. If  $x < -0_{\mathbb{F}}$ , return the [string-concatenation](#) of "-" and [Number::toString](#)(-*x*, *radix*).
4. If *x* is  $+\infty_{\mathbb{F}}$ , return "Infinity".
5. Let *n*, *k*, and *s* be [integers](#) such that  $k \geq 1$ ,  $radix^{k-1} \leq s < radix^k$ ,  $\mathbb{F}(s \times radix^{n-k})$  is *x*, and *k* is as small as possible. Note that *k* is the number of digits in the representation of *s* using radix *radix*, that *s* is not divisible by *radix*, and that the least significant digit of *s* is not necessarily uniquely determined by these criteria.
6. If *radix*  $\neq$  10 or *n* is in the [inclusive interval](#) from -5 to 21, then
  - a. If  $n \geq k$ , then
    - i. Return the [string-concatenation](#) of:
      - the code units of the *k* digits of the representation of *s* using radix *radix*
      - *n* - *k* occurrences of the code unit 0x0030 (DIGIT ZERO)
    - b. Else if  $n > 0$ , then
      - i. Return the [string-concatenation](#) of:
        - the code units of the most significant *n* digits of the representation of *s* using radix *radix*
        - the code unit 0x002E (FULL STOP)
        - the code units of the remaining *k* - *n* digits of the representation of *s* using radix *radix*
      - c. Else,
        - i. [Assert](#):  $n \leq 0$ .
        - ii. Return the [string-concatenation](#) of:
          - the code unit 0x0030 (DIGIT ZERO)
          - the code unit 0x002E (FULL STOP)
          - -*n* occurrences of the code unit 0x0030 (DIGIT ZERO)
          - the code units of the *k* digits of the representation of *s* using radix *radix*
  7. NOTE: In this case, the input will be represented using scientific E notation, such as 1.2e+3.
  8. [Assert](#): *radix* is 10.
  9. If  $n < 0$ , then
    - a. Let *exponentSign* be the code unit 0x002D (HYPHEN-MINUS).
  10. Else,
    - a. Let *exponentSign* be the code unit 0x002B (PLUS SIGN).
  11. If *k* = 1, then
    - a. Return the [string-concatenation](#) of:
      - the code unit of the single digit of *s*

- the code unit 0x0065 (LATIN SMALL LETTER E)
  - *exponentSign*
  - the code units of the decimal representation of  $\text{abs}(n - 1)$
12. Return the *string-concatenation* of:
- the code unit of the most significant digit of the decimal representation of  $s$
  - the code unit 0x002E (FULL STOP)
  - the code units of the remaining  $k - 1$  digits of the decimal representation of  $s$
  - the code unit 0x0065 (LATIN SMALL LETTER E)
  - *exponentSign*
  - the code units of the decimal representation of  $\text{abs}(n - 1)$

NOTE 1 The following observations may be useful as guidelines for implementations, but are not part of the normative requirements of this Standard:

- If  $x$  is any Number value other than  $-0_{\mathbb{F}}$ , then  $\text{ToNumber}(\text{ToString}(x))$  is  $x$ .
- The least significant digit of  $s$  is not always uniquely determined by the requirements listed in step 5.

NOTE 2 For implementations that provide more accurate conversions than required by the rules above, it is recommended that the following alternative version of step 5 be used as a guideline:

5. Let  $n$ ,  $k$ , and  $s$  be integers such that  $k \geq 1$ ,  $\text{radix}^{k-1} \leq s < \text{radix}^k$ ,  $\mathbb{F}(s \times \text{radix}^{n-k})$  is  $x$ , and  $k$  is as small as possible. If there are multiple possibilities for  $s$ , choose the value of  $s$  for which  $s \times \text{radix}^{n-k}$  is closest in value to  $\mathbb{R}(x)$ . If there are two such possible values of  $s$ , choose the one that is even. Note that  $k$  is the number of digits in the representation of  $s$  using radix  $\text{radix}$  and that  $s$  is not divisible by  $\text{radix}$ .

NOTE 3 Implementers of ECMAScript may find useful the paper and code written by David M. Gay for binary-to-decimal conversion of floating-point numbers:

Gay, David M. Correctly Rounded Binary-Decimal and Decimal-Binary Conversions. Numerical Analysis, Manuscript 90-10. AT&T Bell Laboratories (Murray Hill, New Jersey). 30 November 1990. Available as <http://ampl.com/REFS/abstracts.html#rounding>. Associated code available as <http://netlib.sandia.gov/fp/dtoa.c> and as [http://netlib.sandia.gov/fp/g\\_fmt.c](http://netlib.sandia.gov/fp/g_fmt.c) and may also be found at the various **netlib** mirror sites.

## 6.1.6.2 The BigInt Type

The *BigInt type* represents an integer value. The value may be any size and is not limited to a particular bit-width. Generally, where not otherwise noted, operations are designed to return exact mathematically-based answers. For binary operations, BigInts act as two's complement binary strings, with negative numbers treated as having bits set infinitely to the left.

### 6.1.6.2.1 BigInt::unaryMinus ( $x$ )

The abstract operation `BigInt::unaryMinus` takes argument  $x$  (a BigInt) and returns a BigInt. It performs the following steps when called:

1. If  $x$  is  $0_{\mathbb{Z}}$ , return  $0_{\mathbb{Z}}$ .
2. Return the BigInt value that represents the negation of  $\mathbb{R}(x)$ .

### 6.1.6.2.2 BigInt::bitwiseNOT ( *x* )

The abstract operation BigInt::bitwiseNOT takes argument *x* (a BigInt) and returns a BigInt. It returns the one's complement of *x*. It performs the following steps when called:

1. Return  $-x - 1_{\mathbb{Z}}$ .

### 6.1.6.2.3 BigInt::exponentiate ( *base*, *exponent* )

The abstract operation BigInt::exponentiate takes arguments *base* (a BigInt) and *exponent* (a BigInt) and returns either a [normal completion containing](#) a BigInt or a [throw completion](#). It performs the following steps when called:

1. If *exponent*  $< 0_{\mathbb{Z}}$ , throw a **RangeError** exception.
2. If *base* is  $0_{\mathbb{Z}}$  and *exponent* is  $0_{\mathbb{Z}}$ , return  $1_{\mathbb{Z}}$ .
3. Return the BigInt value that represents  $\mathbb{R}(\textit{base})$  raised to the power  $\mathbb{R}(\textit{exponent})$ .

### 6.1.6.2.4 BigInt::multiply ( *x*, *y* )

The abstract operation BigInt::multiply takes arguments *x* (a BigInt) and *y* (a BigInt) and returns a BigInt. It performs the following steps when called:

1. Return the BigInt value that represents the product of *x* and *y*.

**NOTE** Even if the result has a much larger bit width than the input, the exact mathematical answer is given.

### 6.1.6.2.5 BigInt::divide ( *x*, *y* )

The abstract operation BigInt::divide takes arguments *x* (a BigInt) and *y* (a BigInt) and returns either a [normal completion containing](#) a BigInt or a [throw completion](#). It performs the following steps when called:

1. If *y* is  $0_{\mathbb{Z}}$ , throw a **RangeError** exception.
2. Let *quotient* be  $\mathbb{R}(x) / \mathbb{R}(y)$ .
3. Return  $\mathbb{Z}(\textit{truncate}(\textit{quotient}))$ .

### 6.1.6.2.6 BigInt::remainder ( *n*, *d* )

The abstract operation BigInt::remainder takes arguments *n* (a BigInt) and *d* (a BigInt) and returns either a [normal completion containing](#) a BigInt or a [throw completion](#). It performs the following steps when called:

1. If *d* is  $0_{\mathbb{Z}}$ , throw a **RangeError** exception.
2. If *n* is  $0_{\mathbb{Z}}$ , return  $0_{\mathbb{Z}}$ .
3. Let *quotient* be  $\mathbb{R}(n) / \mathbb{R}(d)$ .
4. Let *q* be  $\mathbb{Z}(\textit{truncate}(\textit{quotient}))$ .
5. Return  $n - (d \times q)$ .

**NOTE** The sign of the result is the sign of the dividend.

#### 6.1.6.2.7 BigInt::add ( *x*, *y* )

The abstract operation BigInt::add takes arguments *x* (a BigInt) and *y* (a BigInt) and returns a BigInt. It performs the following steps when called:

1. Return the BigInt value that represents the sum of *x* and *y*.

#### 6.1.6.2.8 BigInt::subtract ( *x*, *y* )

The abstract operation BigInt::subtract takes arguments *x* (a BigInt) and *y* (a BigInt) and returns a BigInt. It performs the following steps when called:

1. Return the BigInt value that represents the difference *x* minus *y*.

#### 6.1.6.2.9 BigInt::leftShift ( *x*, *y* )

The abstract operation BigInt::leftShift takes arguments *x* (a BigInt) and *y* (a BigInt) and returns a BigInt. It performs the following steps when called:

1. If  $y < 0_{\mathbb{Z}}$ , then
  - a. Return the BigInt value that represents  $\mathbb{R}(x) / 2^{-\mathbb{R}(y)}$ , rounding down to the nearest integer, including for negative numbers.
2. Return the BigInt value that represents  $\mathbb{R}(x) \times 2^{\mathbb{R}(y)}$ .

**NOTE** Semantics here should be equivalent to a bitwise shift, treating the BigInt as an infinite length string of binary two's complement digits.

#### 6.1.6.2.10 BigInt::signedRightShift ( *x*, *y* )

The abstract operation BigInt::signedRightShift takes arguments *x* (a BigInt) and *y* (a BigInt) and returns a BigInt. It performs the following steps when called:

1. Return `BigInt::leftShift(x, -y)`.

#### 6.1.6.2.11 BigInt::unsignedRightShift ( *x*, *y* )

The abstract operation BigInt::unsignedRightShift takes arguments *x* (a BigInt) and *y* (a BigInt) and returns a [throw completion](#). It performs the following steps when called:

1. Throw a **TypeError** exception.

#### 6.1.6.2.12 BigInt::lessThan ( *x*, *y* )

The abstract operation BigInt::lessThan takes arguments *x* (a BigInt) and *y* (a BigInt) and returns a Boolean. It performs the following steps when called:

1. If  $\mathbb{R}(x) < \mathbb{R}(y)$ , return **true**; otherwise return **false**.

#### 6.1.6.2.13 BigInt::equal ( *x*, *y* )

The abstract operation BigInt::equal takes arguments *x* (a BigInt) and *y* (a BigInt) and returns a Boolean. It performs the following steps when called:

1. If  $\mathbb{R}(x) = \mathbb{R}(y)$ , return **true**; otherwise return **false**.

#### 6.1.6.2.14 BinaryAnd ( *x*, *y* )

The abstract operation BinaryAnd takes arguments *x* (0 or 1) and *y* (0 or 1) and returns 0 or 1. It performs the following steps when called:

1. If *x* = 1 and *y* = 1, return 1.
2. Else, return 0.

#### 6.1.6.2.15 BinaryOr ( *x*, *y* )

The abstract operation BinaryOr takes arguments *x* (0 or 1) and *y* (0 or 1) and returns 0 or 1. It performs the following steps when called:

1. If *x* = 1 or *y* = 1, return 1.
2. Else, return 0.

#### 6.1.6.2.16 BinaryXor ( *x*, *y* )

The abstract operation BinaryXor takes arguments *x* (0 or 1) and *y* (0 or 1) and returns 0 or 1. It performs the following steps when called:

1. If *x* = 1 and *y* = 0, return 1.
2. Else if *x* = 0 and *y* = 1, return 1.
3. Else, return 0.

#### 6.1.6.2.17 BigIntBitwiseOp ( *op*, *x*, *y* )

The abstract operation BigIntBitwiseOp takes arguments *op* (&, ^, or |), *x* (a BigInt), and *y* (a BigInt) and returns a BigInt. It performs the following steps when called:

1. Set *x* to  $\mathbb{R}(x)$ .
2. Set *y* to  $\mathbb{R}(y)$ .
3. Let *result* be 0.
4. Let *shift* be 0.
5. Repeat, until (*x* = 0 or *x* = -1) and (*y* = 0 or *y* = -1),
  - a. Let *xDigit* be *x* modulo 2.
  - b. Let *yDigit* be *y* modulo 2.
  - c. If *op* is &, set *result* to *result* +  $2^{\text{shift}}$  × BinaryAnd(*xDigit*, *yDigit*).
  - d. Else if *op* is |, set *result* to *result* +  $2^{\text{shift}}$  × BinaryOr(*xDigit*, *yDigit*).
  - e. Else,
    - i. Assert: *op* is ^.
    - ii. Set *result* to *result* +  $2^{\text{shift}}$  × BinaryXor(*xDigit*, *yDigit*).
  - f. Set *shift* to *shift* + 1.
  - g. Set *x* to (*x* - *xDigit*) / 2.
  - h. Set *y* to (*y* - *yDigit*) / 2.
6. If *op* is &, let *tmp* be BinaryAnd(*x* modulo 2, *y* modulo 2).
7. Else if *op* is |, let *tmp* be BinaryOr(*x* modulo 2, *y* modulo 2).
8. Else,
  - a. Assert: *op* is ^.

- b. Let *tmp* be `BinaryXor(x modulo 2, y modulo 2)`.
9. If *tmp*  $\neq$  0, then
  - a. Set *result* to `result - 2shift`.
  - b. NOTE: This extends the sign.
10. Return the `BigInt` value for *result*.

#### 6.1.6.2.18 `BigInt::bitwiseAND ( x, y )`

The abstract operation `BigInt::bitwiseAND` takes arguments *x* (a `BigInt`) and *y* (a `BigInt`) and returns a `BigInt`. It performs the following steps when called:

1. Return `BigIntBitwiseOp(&, x, y)`.

#### 6.1.6.2.19 `BigInt::bitwiseXOR ( x, y )`

The abstract operation `BigInt::bitwiseXOR` takes arguments *x* (a `BigInt`) and *y* (a `BigInt`) and returns a `BigInt`. It performs the following steps when called:

1. Return `BigIntBitwiseOp(^, x, y)`.

#### 6.1.6.2.20 `BigInt::bitwiseOR ( x, y )`

The abstract operation `BigInt::bitwiseOR` takes arguments *x* (a `BigInt`) and *y* (a `BigInt`) and returns a `BigInt`. It performs the following steps when called:

1. Return `BigIntBitwiseOp(|, x, y)`.

#### 6.1.6.2.21 `BigInt::toString ( x, radix )`

The abstract operation `BigInt::toString` takes arguments *x* (a `BigInt`) and *radix* (an integer in the inclusive interval from 2 to 36) and returns a `String`. It represents *x* as a `String` using a positional numeral system with radix *radix*. The digits used in the representation of a `BigInt` using radix *r* are taken from the first *r* code units of "0123456789abcdefghijklmnopqrstuvwxyz" in order. The representation of `BigInt`s other than `0Z` never includes leading zeroes. It performs the following steps when called:

1. If  $x < 0_{\mathbb{Z}}$ , return the string-concatenation of "-" and `BigInt::toString(-x, radix)`.
2. Return the `String` value consisting of the representation of *x* using radix *radix*.

### 6.1.7 The Object Type

An Object is logically a collection of properties. Each property is either a data property, or an accessor property:

- A *data property* associates a key value with an `ECMAScript language value` and a set of Boolean attributes.
- An *accessor property* associates a key value with one or two accessor functions, and a set of Boolean attributes. The accessor functions are used to store or retrieve an `ECMAScript language value` that is associated with the property.

Properties are identified using key values. A *property key* value is either an `ECMAScript String` value or a `Symbol` value. All `String` and `Symbol` values, including the empty `String`, are valid as property keys. A *property name* is a property key that is a `String` value.



An *integer index* is a *String*-valued property key that is a *canonical numeric string* and whose numeric value is either  $+0_{\mathbb{F}}$  or a positive *integral Number*  $\leq \mathbb{F}(2^{53} - 1)$ . An *array index* is an *integer index* whose numeric value  $i$  is in the range  $+0_{\mathbb{F}} \leq i < \mathbb{F}(2^{32} - 1)$ .

Property keys are used to access properties and their values. There are two kinds of access for properties: *get* and *set*, corresponding to value retrieval and assignment, respectively. The properties accessible via *get* and *set* access includes both *own properties* that are a direct part of an object and *inherited properties* which are provided by another associated object via a property inheritance relationship. Inherited properties may be either own or inherited properties of the associated object. Each own property of an object must each have a key value that is distinct from the key values of the other own properties of that object.

All objects are logically collections of properties, but there are multiple forms of objects that differ in their semantics for accessing and manipulating their properties. Please see 6.1.7.2 for definitions of the multiple forms of objects.

### 6.1.7.1 Property Attributes

Attributes are used in this specification to define and explain the state of Object properties as described in Table 3. Unless specified explicitly, the initial value of each attribute is its Default Value.

Table 3: Attributes of an Object property

Attribute Name	Types of property for which it is present	Value Domain	Default Value	Description
[[Value]]	<i>data property</i>	an <i>ECMAScript language value</i>	<b>undefined</b>	The value retrieved by a <i>get</i> access of the property.
[[Writable]]	<i>data property</i>	a Boolean	<b>false</b>	If <b>false</b> , attempts by ECMAScript code to change the property's [[Value]] attribute using [[Set]] will not succeed.
[[Get]]	<i>accessor property</i>	an Object or <b>undefined</b>	<b>undefined</b>	If the value <i>is an Object</i> it must be a <i>function object</i> . The function's [[Call]] internal method (Table 5) is called with an empty arguments list to retrieve the property value each time a <i>get</i> access of the property is performed.
[[Set]]	<i>accessor property</i>	an Object or <b>undefined</b>	<b>undefined</b>	If the value <i>is an Object</i> it must be a <i>function object</i> . The function's [[Call]] internal method (Table 5) is called with an arguments list containing the assigned value as its sole argument each time a <i>set</i> access of the property is performed. The effect of a property's [[Set]] internal method may, but is not required to, have an effect on the value returned by subsequent calls to the property's [[Get]] internal method.

Table 3 (continued)

Attribute Name	Types of property for which it is present	Value Domain	Default Value	Description
[[Enumerable]]	data property or accessor property	a Boolean	false	If <b>true</b> , the property will be enumerated by a for-in enumeration (see 14.7.5). Otherwise, the property is said to be non-enumerable.
[[Configurable]]	data property or accessor property	a Boolean	false	If <b>false</b> , attempts to delete the property, change it from a data property to an accessor property or from an accessor property to a data property, or make any changes to its attributes (other than replacing an existing [[Value]] or setting [[Writable]] to <b>false</b> ) will fail.

### 6.1.7.2 Object Internal Methods and Internal Slots

The actual semantics of objects, in ECMAScript, are specified via algorithms called *internal methods*. Each object in an ECMAScript engine is associated with a set of internal methods that defines its runtime behaviour. These internal methods are not part of the ECMAScript language. They are defined by this specification purely for expository purposes. However, each object within an implementation of ECMAScript must behave as specified by the internal methods associated with it. The exact manner in which this is accomplished is determined by the implementation.

Internal method names are polymorphic. This means that different object values may perform different algorithms when a common internal method name is invoked upon them. That actual object upon which an internal method is invoked is the “target” of the invocation. If, at runtime, the implementation of an algorithm attempts to use an internal method of an object that the object does not support, a **TypeError** exception is thrown.

Internal slots correspond to internal state that is associated with objects and used by various ECMAScript specification algorithms. Internal slots are not object properties and they are not inherited. Depending upon the specific internal slot specification, such state may consist of values of any [ECMAScript language type](#) or of specific ECMAScript specification type values. Unless explicitly specified otherwise, internal slots are allocated as part of the process of creating an object and may not be dynamically added to an object. Unless specified otherwise, the initial value of an internal slot is the value **undefined**. Various algorithms within this specification create objects that have internal slots. However, the ECMAScript language provides no direct way to associate internal slots with an object.

All objects have an internal slot named `[[PrivateElements]]`, which is a [List](#) of [PrivateElements](#). This [List](#) represents the values of the private fields, methods, and accessors for the object. Initially, it is an empty [List](#).

Internal methods and internal slots are identified within this specification using names enclosed in double square brackets `[[ ]]`.

[Table 4](#) summarizes the *essential internal methods* used by this specification that are applicable to all objects created or manipulated by ECMAScript code. Every object must have algorithms for all of the essential internal methods. However, all objects do not necessarily use the same algorithms for those methods.

An *ordinary object* is an object that satisfies all of the following criteria:

- For the internal methods listed in [Table 4](#), the object uses those defined in [10.1](#).
- If the object has a `[[Call]]` internal method, it uses either the one defined in [10.2.1](#) or the one defined in [10.3.1](#).
- If the object has a `[[Construct]]` internal method, it uses either the one defined in [10.2.2](#) or the one defined in [10.3.2](#).

An *exotic object* is an object that is not an [ordinary object](#).

This specification recognizes different kinds of [exotic objects](#) by those objects' internal methods. An object that is behaviourally equivalent to a particular kind of [exotic object](#) (such as an [Array exotic object](#) or a [bound function exotic object](#)), but does not have the same collection of internal methods specified for that kind, is not recognized as that kind of [exotic object](#).

The “Signature” column of [Table 4](#) and other similar tables describes the invocation pattern for each internal method. The invocation pattern always includes a parenthesized list of descriptive parameter names. If a parameter name is the same as an ECMAScript type name then the name describes the required type of the parameter value. If an internal method explicitly returns a value, its parameter list is followed by the symbol “→” and the type name of the returned value. The type names used in signatures refer to the types defined in [clause 6](#) augmented by the following additional names. “*any*” means the value may be any [ECMAScript language type](#).

In addition to its parameters, an internal method always has access to the object that is the target of the method invocation.

An internal method implicitly returns a [Completion Record](#), either a [normal completion](#) that wraps a value of the return type shown in its invocation pattern, or a [throw completion](#).

**Table 4: Essential Internal Methods**

Internal Method	Signature	Description
[[GetPrototypeOf]]	( ) → Object   Null	Determine the object that provides inherited properties for this object. A <b>null</b> value indicates that there are no inherited properties.
[[SetPrototypeOf]]	(Object   Null) → Boolean	Associate this object with another object that provides inherited properties. Passing <b>null</b> indicates that there are no inherited properties. Returns <b>true</b> indicating that the operation was completed successfully or <b>false</b> indicating that the operation was not successful.
[[IsExtensible]]	( ) → Boolean	Determine whether it is permitted to add additional properties to this object.
[[PreventExtensions]]	( ) → Boolean	Control whether new properties may be added to this object. Returns <b>true</b> if the operation was successful or <b>false</b> if the operation was unsuccessful.
[[GetOwnProperty]]	( <i>propertyKey</i> ) → Undefined   <a href="#">Property Descriptor</a>	Return a <a href="#">Property Descriptor</a> for the own property of this object whose key is <i>propertyKey</i> , or <b>undefined</b> if no such property exists.
[[DefineOwnProperty]]	( <i>propertyKey</i> , <a href="#">PropertyDescriptor</a> ) → Boolean	Create or alter the own property, whose key is <i>propertyKey</i> , to have the state described by <a href="#">PropertyDescriptor</a> . Return <b>true</b> if that property was successfully created/updated or <b>false</b> if the property could not be created or updated.
[[HasProperty]]	( <i>propertyKey</i> ) → Boolean	Return a Boolean value indicating whether this object already has either an own or inherited property whose key is <i>propertyKey</i> .
[[Get]]	( <i>propertyKey</i> , <i>Receiver</i> ) → <i>any</i>	Return the value of the property whose key is <i>propertyKey</i> from this object. If any ECMAScript code must be executed to retrieve the property value, <i>Receiver</i> is used as the <b>this</b> value when evaluating the code.

Table 4 (continued)

Internal Method	Signature	Description
[[Set]]	( <i>propertyKey</i> , <i>value</i> , <i>Receiver</i> ) → Boolean	Set the value of the property whose key is <i>propertyKey</i> to <i>value</i> . If any ECMAScript code must be executed to set the property value, <i>Receiver</i> is used as the <b>this</b> value when evaluating the code. Returns <b>true</b> if the property value was set or <b>false</b> if it could not be set.
[[Delete]]	( <i>propertyKey</i> ) → Boolean	Remove the own property whose key is <i>propertyKey</i> from this object. Return <b>false</b> if the property was not deleted and is still present. Return <b>true</b> if the property was deleted or is not present.
[[OwnPropertyKeys]]	() → List of <i>property keys</i>	Return a List whose elements are all of the own <i>property keys</i> for the object.

Table 5 summarizes additional essential internal methods that are supported by objects that may be called as functions. A *function object* is an object that supports the [[Call]] internal method. A *constructor* is an object that supports the [[Construct]] internal method. Every object that supports [[Construct]] must support [[Call]]; that is, every *constructor* must be a *function object*. Therefore, a *constructor* may also be referred to as a *constructor function* or *constructor function object*.

Table 5: Additional Essential Internal Methods of Function Objects

Internal Method	Signature	Description
[[Call]]	( <i>any</i> , a List of <i>any</i> ) → <i>any</i>	Executes code associated with this object. Invoked via a function call expression. The arguments to the internal method are a <b>this</b> value and a List whose elements are the arguments passed to the function by a call expression. Objects that implement this internal method are <i>callable</i> .
[[Construct]]	(a List of <i>any</i> , Object) → Object	Creates an object. Invoked via the <b>new</b> operator or a <b>super</b> call. The first argument to the internal method is a List whose elements are the arguments of the <i>constructor</i> invocation or the <b>super</b> call. The second argument is the object to which the <b>new</b> operator was initially applied. Objects that implement this internal method are called <i>constructors</i> . A <i>function object</i> is not necessarily a <i>constructor</i> and such non- <i>constructor function objects</i> do not have a [[Construct]] internal method.

The semantics of the essential internal methods for *ordinary objects* and standard *exotic objects* are specified in clause 10. If any specified use of an internal method of an *exotic object* is not supported by an implementation, that usage must throw a **TypeError** exception when attempted.

### 6.1.7.3 Invariants of the Essential Internal Methods

The Internal Methods of Objects of an ECMAScript engine must conform to the list of invariants specified below. Ordinary ECMAScript Objects as well as all standard *exotic objects* in this specification maintain these invariants. ECMAScript Proxy objects maintain these invariants by means of runtime checks on the result of traps invoked on the [[ProxyHandler]] object.

Any implementation provided *exotic objects* must also maintain these invariants for those objects. Violation of these invariants may cause ECMAScript code to have unpredictable behaviour and create security issues. However, violation of these invariants must never compromise the memory safety of an implementation.

An implementation must not allow these invariants to be circumvented in any manner such as by providing alternative interfaces that implement the functionality of the essential internal methods without enforcing their invariants.

### Definitions:

- The *target* of an internal method is the object upon which the internal method is called.
- A target is *non-extensible* if it has been observed to return **false** from its `[[IsExtensible]]` internal method, or **true** from its `[[PreventExtensions]]` internal method.
- A *non-existent* property is a property that does not exist as an own property on a non-extensible target.
- All references to *SameValue* are according to the definition of the *SameValue* algorithm.

### Return value:

The value returned by any internal method must be a *Completion Record* with either:

- `[[Type]]` = normal, `[[Target]]` = empty, and `[[Value]]` = a value of the "normal return type" shown below for that internal method, or
- `[[Type]]` = throw, `[[Target]]` = empty, and `[[Value]]` = any *ECMAScript language value*.

NOTE 1 An internal method must not return a *continue completion*, a *break completion*, or a *return completion*.

### `[[GetPrototypeOf]]` ( )

- The normal return type is either Object or Null.
- If target is non-extensible, and `[[GetPrototypeOf]]` returns a value *V*, then any future calls to `[[GetPrototypeOf]]` should return the *SameValue* as *V*.

NOTE 2 An object's prototype chain should have *finite* length (that is, starting from any object, recursively applying the `[[GetPrototypeOf]]` internal method to its result should eventually lead to the value **null**). However, this requirement is not enforceable as an object level invariant if the prototype chain includes any *exotic objects* that do not use the *ordinary object* definition of `[[GetPrototypeOf]]`. Such a circular prototype chain may result in infinite loops when accessing object properties.

### `[[SetPrototypeOf]]` ( *V* )

- The normal return type is Boolean.
- If target is non-extensible, `[[SetPrototypeOf]]` must return **false**, unless *V* is the *SameValue* as the target's observed `[[GetPrototypeOf]]` value.

### `[[IsExtensible]]` ( )

- The normal return type is Boolean.
- If `[[IsExtensible]]` returns **false**, all future calls to `[[IsExtensible]]` on the target must return **false**.

### `[[PreventExtensions]]` ( )

- The normal return type is Boolean.
- If `[[PreventExtensions]]` returns **true**, all future calls to `[[IsExtensible]]` on the target must return **false** and the target is now considered non-extensible.

### `[[GetOwnProperty]]` ( *P* )

- The normal return type is either *Property Descriptor* or Undefined.
- If the Type of the return value is *Property Descriptor*, the return value must be a *fully populated Property Descriptor*.
- If *P* is described as a non-configurable, non-writable own *data property*, all future calls to `[[GetOwnProperty]]` ( *P* ) must return *Property Descriptor* whose `[[Value]]` is *SameValue* as *P*'s `[[Value]]`

attribute.

- If *P*'s attributes other than `[[Writable]]` may change over time or if the property might be deleted, then *P*'s `[[Configurable]]` attribute must be **true**.
- If the `[[Writable]]` attribute may change from **false** to **true**, then the `[[Configurable]]` attribute must be **true**.
- If the target is non-extensible and *P* is non-existent, then all future calls to `[[GetOwnProperty]]` (*P*) on the target must describe *P* as non-existent (i.e. `[[GetOwnProperty]]` (*P*) must return **undefined**).

**NOTE 3** As a consequence of the third invariant, if a property is described as a **data property** and it may return different values over time, then either or both of the `[[Writable]]` and `[[Configurable]]` attributes must be **true** even if no mechanism to change the value is exposed via the other essential internal methods.

### `[[DefineOwnProperty]]` ( *P*, *Desc* )

- The normal return type is Boolean.
- `[[DefineOwnProperty]]` must return **false** if *P* has previously been observed as a non-configurable own property of the target, unless either:
  1. *P* is a writable **data property**. A non-configurable writable **data property** can be changed into a non-configurable non-writable **data property**.
  2. All attributes of *Desc* are the **SameValue** as *P*'s attributes.
- `[[DefineOwnProperty]]` (*P*, *Desc*) must return **false** if target is non-extensible and *P* is a non-existent own property. That is, a non-extensible target object cannot be extended with new properties.

### `[[HasProperty]]` ( *P* )

- The normal return type is Boolean.
- If *P* was previously observed as a non-configurable own data or **accessor property** of the target, `[[HasProperty]]` must return **true**.

### `[[Get]]` ( *P*, *Receiver* )

- The normal return type is any **ECMAScript language type**.
- If *P* was previously observed as a non-configurable, non-writable own **data property** of the target with value *V*, then `[[Get]]` must return the **SameValue** as *V*.
- If *P* was previously observed as a non-configurable own **accessor property** of the target whose `[[Get]]` attribute is **undefined**, the `[[Get]]` operation must return **undefined**.

### `[[Set]]` ( *P*, *V*, *Receiver* )

- The normal return type is Boolean.
- If *P* was previously observed as a non-configurable, non-writable own **data property** of the target, then `[[Set]]` must return **false** unless *V* is the **SameValue** as *P*'s `[[Value]]` attribute.
- If *P* was previously observed as a non-configurable own **accessor property** of the target whose `[[Set]]` attribute is **undefined**, the `[[Set]]` operation must return **false**.

### `[[Delete]]` ( *P* )

- The normal return type is Boolean.
- If *P* was previously observed as a non-configurable own data or **accessor property** of the target, `[[Delete]]` must return **false**.

### `[[OwnPropertyKeys]]` ( )

- The normal return type is **List**.
- The returned **List** must not contain any duplicate entries.
- The Type of each element of the returned **List** is either String or Symbol.
- The returned **List** must contain at least the keys of all non-configurable own properties that have previously been observed.
- If the target is non-extensible, the returned **List** must contain only the keys of all own properties of the target that are observable using `[[GetOwnProperty]]`.

## [[Call]] ( )

- The normal return type is any [ECMAScript language type](#).

## [[Construct]] ( )

- The normal return type is Object.
- The target must also have a `[[Call]]` internal method.

### 6.1.7.4 Well-Known Intrinsic Objects

Well-known intrinsics are built-in objects that are explicitly referenced by the algorithms of this specification and which usually have [realm](#)-specific identities. Unless otherwise specified each intrinsic object actually corresponds to a set of similar objects, one per [realm](#).

Within this specification a reference such as `%name%` means the intrinsic object, associated with the current [realm](#), corresponding to the name. A reference such as `%name.a.b%` means, as if the `"b"` property of the value of the `"a"` property of the intrinsic object `%name%` was accessed prior to any ECMAScript code being evaluated. Determination of the current [realm](#) and its intrinsics is described in [9.4](#). The well-known intrinsics are listed in [Table 6](#).

Table 6: Well-Known Intrinsic Objects

Intrinsic Name	Global Name	ECMAScript Language Association
<code>%AggregateError%</code>	<code>AggregateError</code>	The <code>AggregateError</code> constructor ( <a href="#">20.5.7.1</a> )
<code>%Array%</code>	<code>Array</code>	The <code>Array</code> constructor ( <a href="#">23.1.1</a> )
<code>%ArrayBuffer%</code>	<code>ArrayBuffer</code>	The <code>ArrayBuffer</code> constructor ( <a href="#">25.1.3</a> )
<code>%ArrayIteratorPrototype%</code>		The prototype of <code>Array</code> iterator objects ( <a href="#">23.1.5</a> )
<code>%AsyncFromSyncIteratorPrototype%</code>		The prototype of <code>async-from-sync</code> iterator objects ( <a href="#">27.1.4</a> )
<code>%AsyncFunction%</code>		The constructor of <code>async function</code> objects ( <a href="#">27.7.1</a> )
<code>%AsyncGeneratorFunction%</code>		The constructor of <code>async iterator</code> objects ( <a href="#">27.4.1</a> )
<code>%AsyncIteratorPrototype%</code>		An object that all standard built-in <code>async</code> iterator objects indirectly inherit from
<code>%Atomics%</code>	<code>Atomics</code>	The <code>Atomics</code> object ( <a href="#">25.4</a> )
<code>%BigInt%</code>	<code>BigInt</code>	The <code>BigInt</code> constructor ( <a href="#">21.2.1</a> )
<code>%BigInt64Array%</code>	<code>BigInt64Array</code>	The <code>BigInt64Array</code> constructor ( <a href="#">23.2</a> )
<code>%BigUint64Array%</code>	<code>BigUint64Array</code>	The <code>BigUint64Array</code> constructor ( <a href="#">23.2</a> )
<code>%Boolean%</code>	<code>Boolean</code>	The <code>Boolean</code> constructor ( <a href="#">20.3.1</a> )
<code>%DataView%</code>	<code>DataView</code>	The <code>DataView</code> constructor ( <a href="#">25.3.2</a> )
<code>%Date%</code>	<code>Date</code>	The <code>Date</code> constructor ( <a href="#">21.4.2</a> )
<code>%decodeURI%</code>	<code>decodeURI</code>	The <code>decodeURI</code> function ( <a href="#">19.2.6.1</a> )
<code>%decodeURIComponent%</code>	<code>decodeURIComponent</code>	The <code>decodeURIComponent</code> function ( <a href="#">19.2.6.2</a> )

Table 6 (continued)

Intrinsic Name	Global Name	ECMAScript Language Association
%encodeURIComponent%	<b>encodeURIComponent</b>	The <b>encodeURIComponent</b> function (19.2.6.3)
%encodeURIComponentComponent%	<b>encodeURIComponentComponent</b>	The <b>encodeURIComponentComponent</b> function (19.2.6.4)
%Error%	<b>Error</b>	The Error <b>constructor</b> (20.5.1)
%eval%	<b>eval</b>	The <b>eval</b> function (19.2.1)
%EvalError%	<b>EvalError</b>	The EvalError <b>constructor</b> (20.5.5.1)
%FinalizationRegistry%	<b>FinalizationRegistry</b>	The <b>FinalizationRegistry</b> <b>constructor</b> (26.2.1)
%Float32Array%	<b>Float32Array</b>	The Float32Array <b>constructor</b> (23.2)
%Float64Array%	<b>Float64Array</b>	The Float64Array <b>constructor</b> (23.2)
%ForInIteratorPrototype%		The prototype of For-In iterator objects (14.7.5.10)
%Function%	<b>Function</b>	The Function <b>constructor</b> (20.2.1)
%GeneratorFunction%		The <b>constructor</b> of Generators (27.3.1)
%Int8Array%	<b>Int8Array</b>	The Int8Array <b>constructor</b> (23.2)
%Int16Array%	<b>Int16Array</b>	The Int16Array <b>constructor</b> (23.2)
%Int32Array%	<b>Int32Array</b>	The Int32Array <b>constructor</b> (23.2)
%isFinite%	<b>isFinite</b>	The <b>isFinite</b> function (19.2.2)
%isNaN%	<b>isNaN</b>	The <b>isNaN</b> function (19.2.3)
%IteratorPrototype%		An object that all standard built-in iterator objects indirectly inherit from
%JSON%	<b>JSON</b>	The <b>JSON</b> object (25.5)
%Map%	<b>Map</b>	The Map <b>constructor</b> (24.1.1)
%MapIteratorPrototype%		The prototype of Map iterator objects (24.1.5)
%Math%	<b>Math</b>	The <b>Math</b> object (21.3)
%Number%	<b>Number</b>	The Number <b>constructor</b> (21.1.1)
%Object%	<b>Object</b>	The Object <b>constructor</b> (20.1.1)
%parseFloat%	<b>parseFloat</b>	The <b>parseFloat</b> function (19.2.4)
%parseInt%	<b>parseInt</b>	The <b>parseInt</b> function (19.2.5)
%Promise%	<b>Promise</b>	The Promise <b>constructor</b> (27.2.3)
%Proxy%	<b>Proxy</b>	The Proxy <b>constructor</b> (28.2.1)
%RangeError%	<b>RangeError</b>	The RangeError <b>constructor</b> (20.5.5.2)
%ReferenceError%	<b>ReferenceError</b>	The ReferenceError <b>constructor</b> (20.5.5.3)
%Reflect%	<b>Reflect</b>	The <b>Reflect</b> object (28.1)



Table 6 (continued)

Intrinsic Name	Global Name	ECMAScript Language Association
%RegExp%	<b>RegExp</b>	The RegExp <a href="#">constructor</a> (22.2.4)
%RegExpStringIteratorPrototype%		The prototype of RegExp String Iterator objects (22.2.9)
%Set%	<b>Set</b>	The Set <a href="#">constructor</a> (24.2.1)
%SetIteratorPrototype%		The prototype of Set iterator objects (24.2.5)
%SharedArrayBuffer%	<b>SharedArrayBuffer</b>	The SharedArrayBuffer <a href="#">constructor</a> (25.2.2)
%String%	<b>String</b>	The String <a href="#">constructor</a> (22.1.1)
%StringIteratorPrototype%		The prototype of String iterator objects (22.1.5)
%Symbol%	<b>Symbol</b>	The Symbol <a href="#">constructor</a> (20.4.1)
%SyntaxError%	<b>SyntaxError</b>	The SyntaxError <a href="#">constructor</a> (20.5.5.4)
%ThrowTypeError%		A <a href="#">function object</a> that unconditionally throws a new instance of %TypeError%
%TypedArray%		The super class of all typed Array <a href="#">constructors</a> (23.2.1)
%TypeError%	<b>TypeError</b>	The TypeError <a href="#">constructor</a> (20.5.5.5)
%Uint8Array%	<b>Uint8Array</b>	The Uint8Array <a href="#">constructor</a> (23.2)
%Uint8ClampedArray%	<b>Uint8ClampedArray</b>	The Uint8ClampedArray <a href="#">constructor</a> (23.2)
%Uint16Array%	<b>Uint16Array</b>	The Uint16Array <a href="#">constructor</a> (23.2)
%Uint32Array%	<b>Uint32Array</b>	The Uint32Array <a href="#">constructor</a> (23.2)
%URIError%	<b>URIError</b>	The URIError <a href="#">constructor</a> (20.5.5.6)
%WeakMap%	<b>WeakMap</b>	The WeakMap <a href="#">constructor</a> (24.3.1)
%WeakRef%	<b>WeakRef</b>	The <a href="#">WeakRef constructor</a> (26.1.1)
%WeakSet%	<b>WeakSet</b>	The WeakSet <a href="#">constructor</a> (24.4.1)

NOTE Additional entries in [Table 91](#).

## 6.2 ECMAScript Specification Types

A specification type corresponds to meta-values that are used within algorithms to describe the semantics of ECMAScript language constructs and [ECMAScript language types](#). The specification types include Reference, List, [Completion Record](#), [Property Descriptor](#), [Environment Record](#), [Abstract Closure](#), and [Data Block](#). Specification type values are specification artefacts that do not necessarily correspond to any specific entity within an ECMAScript implementation. Specification type values may be used to describe intermediate results of ECMAScript expression evaluation but such values cannot be stored as properties of objects or values of ECMAScript language variables.

## 6.2.1 The Enum Specification Type

*Enums* are values which are internal to the specification and not directly observable from ECMAScript code. Enums are denoted using a sans-serif typeface. For instance, a [Completion Record](#)'s `[[Type]]` field takes on values like `normal`, `return`, or `throw`. Enums have no characteristics other than their name. The name of an enum serves no purpose other than to distinguish it from other enums, and implies nothing about its usage or meaning in context.

## 6.2.2 The List and Record Specification Types

The *List* type is used to explain the evaluation of argument lists (see [13.3.8](#)) in `new` expressions, in function calls, and in other algorithms where a simple ordered list of values is needed. Values of the List type are simply ordered sequences of list elements containing the individual values. These sequences may be of any length. The elements of a list may be randomly accessed using 0-origin indices. For notational convenience an array-like syntax can be used to access List elements. For example, `arguments[2]` is shorthand for saying the 3<sup>rd</sup> element of the List `arguments`.

When an algorithm iterates over the elements of a List without specifying an order, the order used is the order of the elements in the List.

For notational convenience within this specification, a literal syntax can be used to express a new List value. For example, `« 1, 2 »` defines a List value that has two elements each of which is initialized to a specific value. A new empty List can be expressed as `« »`.

In this specification, the phrase "the *list-concatenation* of `A, B, ...`" (where each argument is a possibly empty List) denotes a new List value whose elements are the concatenation of the elements (in order) of each of the arguments (in order).

The *Record* type is used to describe data aggregations within the algorithms of this specification. A Record type value consists of one or more named fields. The value of each field is an [ECMAScript language value](#) or specification value. Field names are always enclosed in double brackets, for example `[[Value]]`.

For notational convenience within this specification, an object literal-like syntax can be used to express a Record value. For example, `{ [[Field1]]: 42, [[Field2]]: false, [[Field3]]: empty }` defines a Record value that has three fields, each of which is initialized to a specific value. Field name order is not significant. Any fields that are not explicitly listed are considered to be absent.

In specification text and algorithms, dot notation may be used to refer to a specific field of a Record value. For example, if `R` is the record shown in the previous paragraph then `R. [[Field2]]` is shorthand for "the field of `R` named `[[Field2]]`".

Schema for commonly used Record field combinations may be named, and that name may be used as a prefix to a literal Record value to identify the specific kind of aggregations that is being described. For example: `PropertyDescriptor { [[Value]]: 42, [[Writable]]: false, [[Configurable]]: true }`.

## 6.2.3 The Set and Relation Specification Types

The *Set* type is used to explain a collection of unordered elements for use in the [memory model](#). It is distinct from the ECMAScript collection type of the same name. To disambiguate, instances of the ECMAScript collection are consistently referred to as "Set objects" within this specification. Values of the Set type are simple collections of elements, where no element appears more than once. Elements may be added to and removed from Sets. Sets may be unioned, intersected, or subtracted from each other.

The *Relation* type is used to explain constraints on Sets. Values of the Relation type are Sets of ordered pairs of values from its value domain. For example, a Relation on events is a set of ordered pairs of events. For a Relation `R` and two values `a` and `b` in the value domain of `R`, `a R b` is shorthand for saying the ordered

pair  $(a, b)$  is a member of  $R$ . A Relation is least with respect to some conditions when it is the smallest Relation that satisfies those conditions.

A *strict partial order* is a Relation value  $R$  that satisfies the following.

- For all  $a, b$ , and  $c$  in  $R$ 's domain:
  - It is not the case that  $a R a$ , and
  - If  $a R b$  and  $b R c$ , then  $a R c$ .

NOTE 1 The two properties above are called irreflexivity and transitivity, respectively.

A *strict total order* is a Relation value  $R$  that satisfies the following.

- For all  $a, b$ , and  $c$  in  $R$ 's domain:
  - $a$  is  $b$  or  $a R b$  or  $b R a$ , and
  - It is not the case that  $a R a$ , and
  - If  $a R b$  and  $b R c$ , then  $a R c$ .

NOTE 2 The three properties above are called totality, irreflexivity, and transitivity, respectively.

## 6.2.4 The Completion Record Specification Type

The *Completion Record* specification type is used to explain the runtime propagation of values and control flow such as the behaviour of statements (**break**, **continue**, **return** and **throw**) that perform nonlocal transfers of control.

Completion Records have the fields defined in [Table 7](#).

Table 7: Completion Record Fields

Field Name	Value	Meaning
[[Type]]	normal, break, continue, return, or throw	The type of completion that occurred.
[[Value]]	any value except a <a href="#">Completion Record</a>	The value that was produced.
[[Target]]	a String or empty	The target label for directed control transfers.

The following shorthand terms are sometimes used to refer to Completion Records.

- *normal completion* refers to any Completion Record with a [[Type]] value of normal.
- *break completion* refers to any Completion Record with a [[Type]] value of break.
- *continue completion* refers to any Completion Record with a [[Type]] value of continue.
- *return completion* refers to any Completion Record with a [[Type]] value of return.
- *throw completion* refers to any Completion Record with a [[Type]] value of throw.
- *abrupt completion* refers to any Completion Record with a [[Type]] value other than normal.
- *a normal completion containing* some type of value refers to a normal completion that has a value of that type in its [[Value]] field.

Callable objects that are defined in this specification only return a normal completion or a throw completion. Returning any other kind of Completion Record is considered an editorial error.

[Implementation-defined](#) callable objects must return either a normal completion or a throw completion.

### 6.2.4.1 NormalCompletion ( *value* )

The abstract operation NormalCompletion takes argument *value* (any value except a [Completion Record](#)) and returns a [normal completion](#). It performs the following steps when called:

1. Return [Completion Record](#) { `[[Type]]`: normal, `[[Value]]`: *value*, `[[Target]]`: empty }.

### 6.2.4.2 ThrowCompletion ( *value* )

The abstract operation ThrowCompletion takes argument *value* (an [ECMAScript language value](#)) and returns a [throw completion](#). It performs the following steps when called:

1. Return [Completion Record](#) { `[[Type]]`: throw, `[[Value]]`: *value*, `[[Target]]`: empty }.

### 6.2.4.3 UpdateEmpty ( *completionRecord*, *value* )

The abstract operation UpdateEmpty takes arguments *completionRecord* (a [Completion Record](#)) and *value* (any value except a [Completion Record](#)) and returns a [Completion Record](#). It performs the following steps when called:

1. **Assert**: If *completionRecord*.`[[Type]]` is either return or throw, then *completionRecord*.`[[Value]]` is not empty.
2. If *completionRecord*.`[[Value]]` is not empty, return ? *completionRecord*.
3. Return [Completion Record](#) { `[[Type]]`: *completionRecord*.`[[Type]]`, `[[Value]]`: *value*, `[[Target]]`: *completionRecord*.`[[Target]]` }.

## 6.2.5 The Reference Record Specification Type

The *Reference Record* type is used to explain the behaviour of such operators as **delete**, **typeof**, the assignment operators, the **super** keyword and other language features. For example, the left-hand operand of an assignment is expected to produce a Reference Record.

A Reference Record is a resolved name or property binding; its fields are defined by [Table 8](#).

**Table 8: Reference Record Fields**

Field Name	Value	Meaning
<code>[[Base]]</code>	an <a href="#">ECMAScript language value</a> , an <a href="#">Environment Record</a> , or unresolvable	The value or <a href="#">Environment Record</a> which holds the binding. A <code>[[Base]]</code> of unresolvable indicates that the binding could not be resolved.
<code>[[ReferencedName]]</code>	a String, a Symbol, or a <a href="#">Private Name</a>	The name of the binding. Always a String if <code>[[Base]]</code> value is an <a href="#">Environment Record</a> .
<code>[[Strict]]</code>	a Boolean	<b>true</b> if the <a href="#">Reference Record</a> originated in <a href="#">strict mode code</a> , <b>false</b> otherwise.
<code>[[ThisValue]]</code>	an <a href="#">ECMAScript language value</a> or empty	If not empty, the <a href="#">Reference Record</a> represents a property binding that was expressed using the <b>super</b> keyword; it is called a <i>Super Reference Record</i> and its <code>[[Base]]</code> value will never be an <a href="#">Environment Record</a> . In that case, the <code>[[ThisValue]]</code> field holds the <b>this</b> value at the time the <a href="#">Reference Record</a> was created.

The following [abstract operations](#) are used in this specification to operate upon Reference Records:

### 6.2.5.1 IsPropertyReference ( *V* )

The abstract operation IsPropertyReference takes argument *V* (a [Reference Record](#)) and returns a Boolean. It performs the following steps when called:

1. If *V*.[[Base]] is unresolvable, return **false**.
2. If *V*.[[Base]] is an [Environment Record](#), return **false**; otherwise return **true**.

### 6.2.5.2 IsUnresolvableReference ( *V* )

The abstract operation IsUnresolvableReference takes argument *V* (a [Reference Record](#)) and returns a Boolean. It performs the following steps when called:

1. If *V*.[[Base]] is unresolvable, return **true**; otherwise return **false**.

### 6.2.5.3 IsSuperReference ( *V* )

The abstract operation IsSuperReference takes argument *V* (a [Reference Record](#)) and returns a Boolean. It performs the following steps when called:

1. If *V*.[[ThisValue]] is not empty, return **true**; otherwise return **false**.

### 6.2.5.4 IsPrivateReference ( *V* )

The abstract operation IsPrivateReference takes argument *V* (a [Reference Record](#)) and returns a Boolean. It performs the following steps when called:

1. If *V*.[[ReferencedName]] is a [Private Name](#), return **true**; otherwise return **false**.

### 6.2.5.5 GetValue ( *V* )

The abstract operation GetValue takes argument *V* (a [Reference Record](#) or an [ECMAScript language value](#)) and returns either a [normal completion](#) containing an [ECMAScript language value](#) or an [abrupt completion](#). It performs the following steps when called:

1. If *V* is not a [Reference Record](#), return *V*.
2. If [IsUnresolvableReference](#)(*V*) is **true**, throw a **ReferenceError** exception.
3. If [IsPropertyReference](#)(*V*) is **true**, then
  - a. Let *baseObj* be ? [ToObject](#)(*V*.[[Base]]).
  - b. If [IsPrivateReference](#)(*V*) is **true**, then
    - i. Return ? [PrivateGet](#)(*baseObj*, *V*.[[ReferencedName]]).
  - c. Return ? *baseObj*.[[Get]](*V*.[[ReferencedName]], [GetThisValue](#)(*V*)).
4. Else,
  - a. Let *base* be *V*.[[Base]].
  - b. **Assert**: *base* is an [Environment Record](#).
  - c. Return ? *base*.GetBindingValue(*V*.[[ReferencedName]], *V*.[[Strict]]) (see 9.1).

**NOTE** The object that may be created in step 3.a is not accessible outside of the above abstract operation and the [ordinary object](#) `[[Get]]` internal method. An implementation might choose to avoid the actual creation of the object.

### 6.2.5.6 PutValue ( *V*, *W* )

The abstract operation PutValue takes arguments *V* (a [Reference Record](#) or an [ECMAScript language value](#)) and *W* (an [ECMAScript language value](#)) and returns either a [normal completion containing unused](#) or an [abrupt completion](#). It performs the following steps when called:

1. If *V* is not a [Reference Record](#), throw a **ReferenceError** exception.
2. If `IsUnresolvableReference(V)` is **true**, then
  - a. If `V.[[Strict]]` is **true**, throw a **ReferenceError** exception.
  - b. Let *globalObj* be `GetGlobalObject()`.
  - c. Perform ? `Set(globalObj, V.[[ReferencedName]], W, false)`.
  - d. Return unused.
3. If `IsPropertyReference(V)` is **true**, then
  - a. Let *baseObj* be ? `ToObject(V.[[Base]])`.
  - b. If `IsPrivateReference(V)` is **true**, then
    - i. Return ? `PrivateSet(baseObj, V.[[ReferencedName]], W)`.
  - c. Let *succeeded* be ? `baseObj.[[Set]](V.[[ReferencedName]], W, GetThisValue(V))`.
  - d. If *succeeded* is **false** and `V.[[Strict]]` is **true**, throw a **TypeError** exception.
  - e. Return unused.
4. Else,
  - a. Let *base* be `V.[[Base]]`.
  - b. **Assert**: *base* is an [Environment Record](#).
  - c. Return ? `base.SetMutableBinding(V.[[ReferencedName]], W, V.[[Strict]])` (see 9.1).

**NOTE** The object that may be created in step 3.a is not accessible outside of the above abstract operation and the [ordinary object](#) `[[Set]]` internal method. An implementation might choose to avoid the actual creation of that object.

### 6.2.5.7 GetThisValue ( *V* )

The abstract operation GetThisValue takes argument *V* (a [Reference Record](#)) and returns an [ECMAScript language value](#). It performs the following steps when called:

1. **Assert**: `IsPropertyReference(V)` is **true**.
2. If `IsSuperReference(V)` is **true**, return `V.[[ThisValue]]`; otherwise return `V.[[Base]]`.

### 6.2.5.8 InitializeReferencedBinding ( *V*, *W* )

The abstract operation InitializeReferencedBinding takes arguments *V* (a [Reference Record](#)) and *W* (an [ECMAScript language value](#)) and returns either a [normal completion containing unused](#) or an [abrupt completion](#). It performs the following steps when called:

1. **Assert**: `IsUnresolvableReference(V)` is **false**.
2. Let *base* be `V.[[Base]]`.
3. **Assert**: *base* is an [Environment Record](#).
4. Return ? `base.InitializeBinding(V.[[ReferencedName]], W)`.

### 6.2.5.9 MakePrivateReference ( *baseValue*, *privateIdentifier* )

The abstract operation MakePrivateReference takes arguments *baseValue* (an ECMAScript language value) and *privateIdentifier* (a String) and returns a Reference Record. It performs the following steps when called:

1. Let *privEnv* be the running execution context's PrivateEnvironment.
2. Assert: *privEnv* is not null.
3. Let *privateName* be ResolvePrivateIdentifier(*privEnv*, *privateIdentifier*).
4. Return the Reference Record { [[Base]]: *baseValue*, [[ReferencedName]]: *privateName*, [[Strict]]: true, [[ThisValue]]: empty }.

### 6.2.6 The Property Descriptor Specification Type

The *Property Descriptor* type is used to explain the manipulation and reification of Object property attributes. A Property Descriptor is a Record with zero or more fields, where each field's name is an attribute name and its value is a corresponding attribute value as specified in 6.1.7.1. The schema name used within this specification to tag literal descriptions of Property Descriptor records is "PropertyDescriptor".

Property Descriptor values may be further classified as data Property Descriptors and accessor Property Descriptors based upon the existence or use of certain fields. A data Property Descriptor is one that includes any fields named either [[Value]] or [[Writable]]. An accessor Property Descriptor is one that includes any fields named either [[Get]] or [[Set]]. Any Property Descriptor may have fields named [[Enumerable]] and [[Configurable]]. A Property Descriptor value may not be both a data Property Descriptor and an accessor Property Descriptor; however, it may be neither (in which case it is a generic Property Descriptor). A *fully populated Property Descriptor* is one that is either an accessor Property Descriptor or a data Property Descriptor and that has all of the corresponding fields defined in Table 3.

The following abstract operations are used in this specification to operate upon Property Descriptor values:

#### 6.2.6.1 IsAccessorDescriptor ( *Desc* )

The abstract operation IsAccessorDescriptor takes argument *Desc* (a Property Descriptor or undefined) and returns a Boolean. It performs the following steps when called:

1. If *Desc* is undefined, return false.
2. If *Desc* has a [[Get]] field, return true.
3. If *Desc* has a [[Set]] field, return true.
4. Return false.

#### 6.2.6.2 IsDataDescriptor ( *Desc* )

The abstract operation IsDataDescriptor takes argument *Desc* (a Property Descriptor or undefined) and returns a Boolean. It performs the following steps when called:

1. If *Desc* is undefined, return false.
2. If *Desc* has a [[Value]] field, return true.
3. If *Desc* has a [[Writable]] field, return true.
4. Return false.

#### 6.2.6.3 IsGenericDescriptor ( *Desc* )

The abstract operation IsGenericDescriptor takes argument *Desc* (a Property Descriptor or undefined) and returns a Boolean. It performs the following steps when called:

1. If *Desc* is **undefined**, return **false**.
2. If `IsAccessorDescriptor(Desc)` is **true**, return **false**.
3. If `IsDataDescriptor(Desc)` is **true**, return **false**.
4. Return **true**.

#### 6.2.6.4 FromPropertyDescriptor ( *Desc* )

The abstract operation `FromPropertyDescriptor` takes argument *Desc* (a [Property Descriptor](#) or **undefined**) and returns an Object or **undefined**. It performs the following steps when called:

1. If *Desc* is **undefined**, return **undefined**.
2. Let *obj* be `OrdinaryObjectCreate(%Object.prototype%)`.
3. **Assert**: *obj* is an extensible [ordinary object](#) with no own properties.
4. If *Desc* has a `[[Value]]` field, then
  - a. Perform ! `CreateDataPropertyOrThrow(obj, "value", Desc.[[Value]])`.
5. If *Desc* has a `[[Writable]]` field, then
  - a. Perform ! `CreateDataPropertyOrThrow(obj, "writable", Desc.[[Writable]])`.
6. If *Desc* has a `[[Get]]` field, then
  - a. Perform ! `CreateDataPropertyOrThrow(obj, "get", Desc.[[Get]])`.
7. If *Desc* has a `[[Set]]` field, then
  - a. Perform ! `CreateDataPropertyOrThrow(obj, "set", Desc.[[Set]])`.
8. If *Desc* has an `[[Enumerable]]` field, then
  - a. Perform ! `CreateDataPropertyOrThrow(obj, "enumerable", Desc.[[Enumerable]])`.
9. If *Desc* has a `[[Configurable]]` field, then
  - a. Perform ! `CreateDataPropertyOrThrow(obj, "configurable", Desc.[[Configurable]])`.
10. Return *obj*.

#### 6.2.6.5 ToPropertyDescriptor ( *Obj* )

The abstract operation `ToPropertyDescriptor` takes argument *Obj* (an [ECMAScript language value](#)) and returns either a [normal completion](#) containing a [Property Descriptor](#) or a [throw completion](#). It performs the following steps when called:

1. If *Obj* is not an [Object](#), throw a **TypeError** exception.
2. Let *desc* be a new [Property Descriptor](#) that initially has no fields.
3. Let *hasEnumerable* be `? HasProperty(Obj, "enumerable")`.
4. If *hasEnumerable* is **true**, then
  - a. Let *enumerable* be `ToBoolean(? Get(Obj, "enumerable"))`.
  - b. Set *desc*.[[Enumerable]] to *enumerable*.
5. Let *hasConfigurable* be `? HasProperty(Obj, "configurable")`.
6. If *hasConfigurable* is **true**, then
  - a. Let *configurable* be `ToBoolean(? Get(Obj, "configurable"))`.
  - b. Set *desc*.[[Configurable]] to *configurable*.
7. Let *hasValue* be `? HasProperty(Obj, "value")`.
8. If *hasValue* is **true**, then
  - a. Let *value* be `? Get(Obj, "value")`.
  - b. Set *desc*.[[Value]] to *value*.
9. Let *hasWritable* be `? HasProperty(Obj, "writable")`.
10. If *hasWritable* is **true**, then
  - a. Let *writable* be `ToBoolean(? Get(Obj, "writable"))`.
  - b. Set *desc*.[[Writable]] to *writable*.



11. Let *hasGet* be ? `HasProperty(Obj, "get")`.
12. If *hasGet* is **true**, then
  - a. Let *getter* be ? `Get(Obj, "get")`.
  - b. If `IsCallable(getter)` is **false** and *getter* is not **undefined**, throw a **TypeError** exception.
  - c. Set *desc*.[[Get]] to *getter*.
13. Let *hasSet* be ? `HasProperty(Obj, "set")`.
14. If *hasSet* is **true**, then
  - a. Let *setter* be ? `Get(Obj, "set")`.
  - b. If `IsCallable(setter)` is **false** and *setter* is not **undefined**, throw a **TypeError** exception.
  - c. Set *desc*.[[Set]] to *setter*.
15. If *desc* has a [[Get]] field or *desc* has a [[Set]] field, then
  - a. If *desc* has a [[Value]] field or *desc* has a [[Writable]] field, throw a **TypeError** exception.
16. Return *desc*.

### 6.2.6.6 CompletePropertyDescriptor ( *Desc* )

The abstract operation `CompletePropertyDescriptor` takes argument *Desc* (a `Property Descriptor`) and returns unused. It performs the following steps when called:

1. Let *like* be the `Record` { [[Value]]: **undefined**, [[Writable]]: **false**, [[Get]]: **undefined**, [[Set]]: **undefined**, [[Enumerable]]: **false**, [[Configurable]]: **false** }.
2. If `IsGenericDescriptor(Desc)` is **true** or `IsDataDescriptor(Desc)` is **true**, then
  - a. If *Desc* does not have a [[Value]] field, set *Desc*.[[Value]] to *like*.[[Value]].
  - b. If *Desc* does not have a [[Writable]] field, set *Desc*.[[Writable]] to *like*.[[Writable]].
3. Else,
  - a. If *Desc* does not have a [[Get]] field, set *Desc*.[[Get]] to *like*.[[Get]].
  - b. If *Desc* does not have a [[Set]] field, set *Desc*.[[Set]] to *like*.[[Set]].
4. If *Desc* does not have an [[Enumerable]] field, set *Desc*.[[Enumerable]] to *like*.[[Enumerable]].
5. If *Desc* does not have a [[Configurable]] field, set *Desc*.[[Configurable]] to *like*.[[Configurable]].
6. Return unused.

### 6.2.7 The Environment Record Specification Type

The `Environment Record` type is used to explain the behaviour of name resolution in nested functions and blocks. This type and the operations upon it are defined in 9.1.

### 6.2.8 The Abstract Closure Specification Type

The `Abstract Closure` specification type is used to refer to algorithm steps together with a collection of values. Abstract Closures are meta-values and are invoked using function application style such as `closure(arg1, arg2)`. Like `abstract operations`, invocations perform the algorithm steps described by the Abstract Closure.

In algorithm steps that create an Abstract Closure, values are captured with the verb "capture" followed by a list of aliases. When an Abstract Closure is created, it captures the value that is associated with each alias at that time. In steps that specify the algorithm to be performed when an Abstract Closure is called, each captured value is referred to by the alias that was used to capture the value.

If an Abstract Closure returns a `Completion Record`, that `Completion Record`'s [[Type]] must be either normal or throw.

Abstract Closures are created inline as part of other algorithms, shown in the following example.

1. Let *addend* be 41.
2. Let *closure* be a new [Abstract Closure](#) with parameters (*x*) that captures *addend* and performs the following steps when called:
  - a. Return  $x + \textit{addend}$ .
3. Let *val* be *closure*(1).
4. **Assert:** *val* is 42.

## 6.2.9 Data Blocks

The *Data Block* specification type is used to describe a distinct and mutable sequence of byte-sized (8 bit) numeric values. A *byte value* is an [integer](#) in the [inclusive interval](#) from 0 to 255. A Data Block value is created with a fixed number of bytes that each have the initial value 0.

For notational convenience within this specification, an array-like syntax can be used to access the individual bytes of a Data Block value. This notation presents a Data Block value as a 0-origin [integer](#)-indexed sequence of bytes. For example, if *db* is a 5 byte Data Block value then *db*[2] can be used to access its 3<sup>rd</sup> byte.

A data block that resides in memory that can be referenced from multiple [agents](#) concurrently is designated a *Shared Data Block*. A Shared Data Block has an identity (for the purposes of equality testing Shared Data Block values) that is *address-free*: it is tied not to the virtual addresses the block is mapped to in any process, but to the set of locations in memory that the block represents. Two data blocks are equal only if the sets of the locations they contain are equal; otherwise, they are not equal and the intersection of the sets of locations they contain is empty. Finally, Shared Data Blocks can be distinguished from Data Blocks.

The semantics of Shared Data Blocks is defined using [Shared Data Block events](#) by the [memory model](#). [Abstract operations](#) below introduce [Shared Data Block events](#) and act as the interface between evaluation semantics and the event semantics of the [memory model](#). The events form a [candidate execution](#), on which the [memory model](#) acts as a filter. Please consult the [memory model](#) for full semantics.

[Shared Data Block events](#) are modeled by [Records](#), defined in the [memory model](#).

The following [abstract operations](#) are used in this specification to operate upon Data Block values:

### 6.2.9.1 CreateByteDataBlock ( *size* )

The abstract operation CreateByteDataBlock takes argument *size* (a non-negative [integer](#)) and returns either a [normal completion containing a Data Block](#) or a [throw completion](#). It performs the following steps when called:

1. Let *db* be a new [Data Block](#) value consisting of *size* bytes. If it is impossible to create such a [Data Block](#), throw a **RangeError** exception.
2. Set all of the bytes of *db* to 0.
3. Return *db*.

### 6.2.9.2 CreateSharedByteDataBlock ( *size* )

The abstract operation CreateSharedByteDataBlock takes argument *size* (a non-negative [integer](#)) and returns either a [normal completion containing a Shared Data Block](#) or a [throw completion](#). It performs the following steps when called:

1. Let *db* be a new [Shared Data Block](#) value consisting of *size* bytes. If it is impossible to create such a [Shared Data Block](#), throw a **RangeError** exception.
2. Let *execution* be the [\[\[CandidateExecution\]\]](#) field of the [surrounding agent's Agent Record](#).

3. Let *eventsRecord* be the Agent Events Record of *execution*.[[EventsRecords]] whose [[AgentSignifier]] is *AgentSignifier*().
4. Let *zero* be « 0 ».
5. For each index *i* of *db*, do
  - a. Append *WriteSharedMemory* { [[Order]]: Init, [[NoTear]]: **true**, [[Block]]: *db*, [[ByteIndex]]: *i*, [[ElementSize]]: 1, [[Payload]]: *zero* } to *eventsRecord*.[[EventList]].
6. Return *db*.

### 6.2.9.3 CopyDataBlockBytes ( *toBlock*, *toIndex*, *fromBlock*, *fromIndex*, *count* )

The abstract operation CopyDataBlockBytes takes arguments *toBlock* (a Data Block or a Shared Data Block), *toIndex* (a non-negative integer), *fromBlock* (a Data Block or a Shared Data Block), *fromIndex* (a non-negative integer), and *count* (a non-negative integer) and returns unused. It performs the following steps when called:

1. **Assert**: *fromBlock* and *toBlock* are distinct values.
2. Let *fromSize* be the number of bytes in *fromBlock*.
3. **Assert**: *fromIndex* + *count* ≤ *fromSize*.
4. Let *toSize* be the number of bytes in *toBlock*.
5. **Assert**: *toIndex* + *count* ≤ *toSize*.
6. Repeat, while *count* > 0,
  - a. If *fromBlock* is a Shared Data Block, then
    - i. Let *execution* be the [[CandidateExecution]] field of the surrounding agent's Agent Record.
    - ii. Let *eventsRecord* be the Agent Events Record of *execution*.[[EventsRecords]] whose [[AgentSignifier]] is *AgentSignifier*().
    - iii. Let *bytes* be a List whose sole element is a nondeterministically chosen byte value.
    - iv. NOTE: In implementations, *bytes* is the result of a non-atomic read instruction on the underlying hardware. The nondeterminism is a semantic prescription of the memory model to describe observable behaviour of hardware with weak consistency.
    - v. Let *readEvent* be *ReadSharedMemory* { [[Order]]: Unordered, [[NoTear]]: **true**, [[Block]]: *fromBlock*, [[ByteIndex]]: *fromIndex*, [[ElementSize]]: 1 }.
    - vi. Append *readEvent* to *eventsRecord*.[[EventList]].
    - vii. Append Chosen Value Record { [[Event]]: *readEvent*, [[ChosenValue]]: *bytes* } to *execution*.[[ChosenValues]].
    - viii. If *toBlock* is a Shared Data Block, then
      1. Append *WriteSharedMemory* { [[Order]]: Unordered, [[NoTear]]: **true**, [[Block]]: *toBlock*, [[ByteIndex]]: *toIndex*, [[ElementSize]]: 1, [[Payload]]: *bytes* } to *eventsRecord*.[[EventList]].
    - ix. Else,
      1. Set *toBlock*[*toIndex*] to *bytes*[0].
  - b. Else,
    - i. **Assert**: *toBlock* is not a Shared Data Block.
    - ii. Set *toBlock*[*toIndex*] to *fromBlock*[*fromIndex*].
  - c. Set *toIndex* to *toIndex* + 1.
  - d. Set *fromIndex* to *fromIndex* + 1.
  - e. Set *count* to *count* - 1.
7. Return unused.

## 6.2.10 The PrivateElement Specification Type

The PrivateElement type is a [Record](#) used in the specification of private class fields, methods, and accessors. Although [Property Descriptors](#) are not used for private elements, private fields behave similarly to non-configurable, non-enumerable, writable [data properties](#), private methods behave similarly to non-configurable, non-enumerable, non-writable [data properties](#), and private accessors behave similarly to non-configurable, non-enumerable [accessor properties](#).

Values of the PrivateElement type are [Record](#) values whose fields are defined by [Table 9](#). Such values are referred to as *PrivateElements*.

Table 9: PrivateElement Fields

Field Name	Values of the <code>[[Kind]]</code> field for which it is present	Value	Meaning
<code>[[Key]]</code>	All	a <a href="#">Private Name</a>	The name of the field, method, or accessor.
<code>[[Kind]]</code>	All	field, method, or accessor	The kind of the element.
<code>[[Value]]</code>	field and method	an <a href="#">ECMAScript language value</a>	The value of the field.
<code>[[Get]]</code>	accessor	a <a href="#">function object</a> or <b>undefined</b>	The getter for a private accessor.
<code>[[Set]]</code>	accessor	a <a href="#">function object</a> or <b>undefined</b>	The setter for a private accessor.

## 6.2.11 The ClassFieldDefinition Record Specification Type

The ClassFieldDefinition type is a [Record](#) used in the specification of class fields.

Values of the ClassFieldDefinition type are [Record](#) values whose fields are defined by [Table 10](#). Such values are referred to as *ClassFieldDefinition Records*.

Table 10: ClassFieldDefinition Record Fields

Field Name	Value	Meaning
<code>[[Name]]</code>	a <a href="#">Private Name</a> , a String, or a Symbol	The name of the field.
<code>[[Initializer]]</code>	a <a href="#">function object</a> or empty	The initializer of the field, if any.

## 6.2.12 Private Names

The *Private Name* specification type is used to describe a globally unique value (one which differs from any other Private Name, even if they are otherwise indistinguishable) which represents the key of a private class element (field, method, or accessor). Each Private Name has an associated immutable `[[Description]]` which is a [String](#) value. A Private Name may be installed on any ECMAScript object with [PrivateFieldAdd](#) or [PrivateMethodOrAccessorAdd](#), and then read or written using [PrivateGet](#) and [PrivateSet](#).

## 6.2.13 The ClassStaticBlockDefinition Record Specification Type

A *ClassStaticBlockDefinition Record* is a [Record](#) value used to encapsulate the executable code for a class static initialization block.

ClassStaticBlockDefinition Records have the fields listed in Table 11.

Table 11: ClassStaticBlockDefinition Record Fields

Field Name	Value	Meaning
[[BodyFunction]]	a <a href="#">function object</a>	The <a href="#">function object</a> to be called during static initialization of a class.

## 7 Abstract Operations

These operations are not a part of the ECMAScript language; they are defined here solely to aid the specification of the semantics of the ECMAScript language. Other, more specialized [abstract operations](#) are defined throughout this specification.

### 7.1 Type Conversion

The ECMAScript language implicitly performs automatic type conversion as needed. To clarify the semantics of certain constructs it is useful to define a set of conversion [abstract operations](#). The conversion [abstract operations](#) are polymorphic; they can accept a value of any [ECMAScript language type](#). But no other specification types are used with these operations.

The [BigInt type](#) has no implicit conversions in the ECMAScript language; programmers must call `BigInt` explicitly to convert values from other types.

#### 7.1.1 ToPrimitive ( *input* [ , *preferredType* ] )

The abstract operation `ToPrimitive` takes argument *input* (an [ECMAScript language value](#)) and optional argument *preferredType* (string or number) and returns either a [normal completion containing an ECMAScript language value](#) or a [throw completion](#). It converts its *input* argument to a non-Object type. If an object is capable of converting to more than one primitive type, it may use the optional hint *preferredType* to favour that type. It performs the following steps when called:

1. If *input* is an Object, then
  - a. Let *exoticToPrim* be ? `GetMethod(input, @@toPrimitive)`.
  - b. If *exoticToPrim* is not **undefined**, then
    - i. If *preferredType* is not present, let *hint* be **"default"**.
    - ii. Else if *preferredType* is string, let *hint* be **"string"**.
    - iii. Else,
      1. **Assert:** *preferredType* is number.
      2. Let *hint* be **"number"**.
    - iv. Let *result* be ? `Call(exoticToPrim, input, « hint »)`.
    - v. If *result* is not an Object, return *result*.
    - vi. Throw a **TypeError** exception.
  - c. If *preferredType* is not present, let *preferredType* be number.
  - d. Return ? `OrdinaryToPrimitive(input, preferredType)`.
2. Return *input*.

**NOTE** When `ToPrimitive` is called without a hint, then it generally behaves as if the hint were number. However, objects may over-ride this behaviour by defining a `@@toPrimitive` method. Of the objects defined in this specification only Dates (see [21.4.4.45](#)) and Symbol objects (see [20.4.3.5](#)) over-ride the default `ToPrimitive` behaviour. Dates treat the absence of a hint as if the hint were string.

### 7.1.1.1 OrdinaryToPrimitive ( *O*, *hint* )

The abstract operation OrdinaryToPrimitive takes arguments *O* (an Object) and *hint* (string or number) and returns either a [normal completion containing an ECMAScript language value](#) or a [throw completion](#). It performs the following steps when called:

1. If *hint* is string, then
  - a. Let *methodNames* be « "toString", "valueOf" ».
2. Else,
  - a. Let *methodNames* be « "valueOf", "toString" ».
3. For each element *name* of *methodNames*, do
  - a. Let *method* be ? [Get](#)(*O*, *name*).
  - b. If [IsCallable](#)(*method*) is **true**, then
    - i. Let *result* be ? [Call](#)(*method*, *O*).
    - ii. If *result* is not an Object, return *result*.
4. Throw a **TypeError** exception.

### 7.1.2 ToBoolean ( *argument* )

The abstract operation ToBoolean takes argument *argument* (an ECMAScript language value) and returns a Boolean. It converts *argument* to a value of type Boolean. It performs the following steps when called:

1. If *argument* is a Boolean, return *argument*.
2. If *argument* is one of **undefined**, **null**, **+0<sub>F</sub>**, **-0<sub>F</sub>**, **NaN**, **0<sub>Z</sub>**, or the empty String, return **false**.
3. NOTE: This step is replaced in section [B.3.6.1](#).
4. Return **true**.

### 7.1.3 ToNumeric ( *value* )

The abstract operation ToNumeric takes argument *value* (an ECMAScript language value) and returns either a [normal completion containing either a Number or a BigInt](#), or a [throw completion](#). It returns *value* converted to a Number or a BigInt. It performs the following steps when called:

1. Let *primValue* be ? [ToPrimitive](#)(*value*, number).
2. If *primValue* is a BigInt, return *primValue*.
3. Return ? [ToNumber](#)(*primValue*).

### 7.1.4 ToNumber ( *argument* )

The abstract operation ToNumber takes argument *argument* (an ECMAScript language value) and returns either a [normal completion containing a Number](#) or a [throw completion](#). It converts *argument* to a value of type Number. It performs the following steps when called:

1. If *argument* is a Number, return *argument*.
2. If *argument* is either a Symbol or a BigInt, throw a **TypeError** exception.
3. If *argument* is **undefined**, return **NaN**.
4. If *argument* is either **null** or **false**, return **+0<sub>F</sub>**.
5. If *argument* is **true**, return **1<sub>F</sub>**.
6. If *argument* is a String, return [StringToNumber](#)(*argument*).
7. Assert: *argument* is an Object.

8. Let *primValue* be ? *ToPrimitive*(*argument*, number).
9. Assert: *primValue* is not an Object.
10. Return ? *ToNumber*(*primValue*).

### 7.1.4.1 ToNumber Applied to the String Type

The abstract operation *StringToNumber* specifies how to convert a String value to a Number value, using the following grammar.

#### Syntax

```

StringNumericLiteral :::
  StrWhiteSpaceopt
  StrWhiteSpaceopt StrNumericLiteral StrWhiteSpaceopt

StrWhiteSpace :::
  StrWhiteSpaceChar StrWhiteSpaceopt

StrWhiteSpaceChar :::
  WhiteSpace
  LineTerminator

StrNumericLiteral :::
  StrDecimalLiteral
  NonDecimalIntegerLiteral[~Sep]

StrDecimalLiteral :::
  StrUnsignedDecimalLiteral
  + StrUnsignedDecimalLiteral
  - StrUnsignedDecimalLiteral

StrUnsignedDecimalLiteral :::
  Infinity
  DecimalDigits[~Sep] . DecimalDigits[~Sep]opt ExponentPart[~Sep]opt
  . DecimalDigits[~Sep] ExponentPart[~Sep]opt
  DecimalDigits[~Sep] ExponentPart[~Sep]opt

```

All grammar symbols not explicitly defined above have the definitions used in the Lexical Grammar for numeric literals (12.9.3)

**NOTE** Some differences should be noted between the syntax of a *StringNumericLiteral* and a *NumericLiteral*:

- A *StringNumericLiteral* may include leading and/or trailing white space and/or line terminators.
- A *StringNumericLiteral* that is decimal may have any number of leading 0 digits.
- A *StringNumericLiteral* that is decimal may include a + or - to indicate its sign.
- A *StringNumericLiteral* that is empty or contains only white space is converted to **+0<sub>F</sub>**.
- **Infinity** and **-Infinity** are recognized as a *StringNumericLiteral* but not as a *NumericLiteral*.
- A *StringNumericLiteral* cannot include a *BigIntLiteralSuffix*.
- A *StringNumericLiteral* cannot include a *NumericLiteralSeparator*.

### 7.1.4.1.1 StringToNumber ( *str* )

The abstract operation StringToNumber takes argument *str* (a String) and returns a Number. It performs the following steps when called:

1. Let *text* be `StringToCodePoints(str)`.
2. Let *literal* be `ParseText(text, StringNumericLiteral)`.
3. If *literal* is a List of errors, return **NaN**.
4. Return `StringNumericValue` of *literal*.

### 7.1.4.1.2 Runtime Semantics: StringNumericValue

The *syntax-directed operation* StringNumericValue takes no arguments and returns a Number.

**NOTE** The conversion of a *StringNumericLiteral* to a Number value is similar overall to the determination of the *NumericValue* of a *NumericLiteral* (see 12.9.3), but some of the details are different.

It is defined piecewise over the following productions:

*StringNumericLiteral* ::: *StrWhiteSpace*<sub>opt</sub>

1. Return **+0**<sub>F</sub>.

*StringNumericLiteral* ::: *StrWhiteSpace*<sub>opt</sub> *StrNumericLiteral* *StrWhiteSpace*<sub>opt</sub>

1. Return `StringNumericValue` of *StrNumericLiteral*.

*StrNumericLiteral* ::: *NonDecimalIntegerLiteral*

1. Return  $\mathbb{F}(\text{MV of } \textit{NonDecimalIntegerLiteral})$ .

*StrDecimalLiteral* ::: - *StrUnsignedDecimalLiteral*

1. Let *a* be `StringNumericValue` of *StrUnsignedDecimalLiteral*.
2. If *a* is **+0**<sub>F</sub>, return **-0**<sub>F</sub>.
3. Return *-a*.

*StrUnsignedDecimalLiteral* ::: **Infinity**

1. Return **+∞**<sub>F</sub>.

*StrUnsignedDecimalLiteral* ::: *DecimalDigits* . *DecimalDigits*<sub>opt</sub> *ExponentPart*<sub>opt</sub>

1. Let *a* be MV of the first *DecimalDigits*.
2. If the second *DecimalDigits* is present, then
  - a. Let *b* be MV of the second *DecimalDigits*.
  - b. Let *n* be the number of code points in the second *DecimalDigits*.
3. Else,
  - a. Let *b* be 0.
  - b. Let *n* be 0.
4. If *ExponentPart* is present, let *e* be MV of *ExponentPart*. Otherwise, let *e* be 0.
5. Return `RoundMVResult((a + (b × 10-n)) × 10e)`.



*StrUnsignedDecimalLiteral* ::: *DecimalDigits ExponentPart*<sub>opt</sub>

1. Let *b* be MV of *DecimalDigits*.
2. If *ExponentPart* is present, let *e* be MV of *ExponentPart*. Otherwise, let *e* be 0.
3. Let *n* be the number of code points in *DecimalDigits*.
4. Return `RoundMVResult( $b \times 10^{e - n}$ )`.

*StrUnsignedDecimalLiteral* ::: *DecimalDigits ExponentPart*<sub>opt</sub>

1. Let *a* be MV of *DecimalDigits*.
2. If *ExponentPart* is present, let *e* be MV of *ExponentPart*. Otherwise, let *e* be 0.
3. Return `RoundMVResult( $a \times 10^e$ )`.

### 7.1.4.1.3 RoundMVResult ( *n* )

The abstract operation `RoundMVResult` takes argument *n* (a [mathematical value](#)) and returns a Number. It converts *n* to a Number in an [implementation-defined](#) manner. For the purposes of this abstract operation, a digit is significant if it is not zero or there is a non-zero digit to its left and there is a non-zero digit to its right. For the purposes of this abstract operation, "the [mathematical value](#) denoted by" a representation of a [mathematical value](#) is the inverse of "the decimal representation of" a [mathematical value](#). It performs the following steps when called:

1. If the decimal representation of *n* has 20 or fewer significant digits, return  $\mathbb{F}(n)$ .
2. Let *option1* be the [mathematical value](#) denoted by the result of replacing each significant digit in the decimal representation of *n* after the 20th with a 0 digit.
3. Let *option2* be the [mathematical value](#) denoted by the result of replacing each significant digit in the decimal representation of *n* after the 20th with a 0 digit and then incrementing it at the 20th position (with carrying as necessary).
4. Let *chosen* be an [implementation-defined](#) choice of either *option1* or *option2*.
5. Return  $\mathbb{F}(\textit{chosen})$ .

### 7.1.5 ToIntegerOrInfinity ( *argument* )

The abstract operation `ToIntegerOrInfinity` takes argument *argument* (an [ECMAScript language value](#)) and returns either a [normal completion containing](#) either an [integer](#),  $+\infty$ , or  $-\infty$ , or a [throw completion](#). It converts *argument* to an [integer](#) representing its Number value with fractional part truncated, or to  $+\infty$  or  $-\infty$  when that Number value is infinite. It performs the following steps when called:

1. Let *number* be `? ToNumber(argument)`.
2. If *number* is one of **NaN**,  $+\mathbf{0}_{\mathbb{F}}$ , or  $-\mathbf{0}_{\mathbb{F}}$ , return 0.
3. If *number* is  $+\infty_{\mathbb{F}}$ , return  $+\infty$ .
4. If *number* is  $-\infty_{\mathbb{F}}$ , return  $-\infty$ .
5. Return `truncate( $\mathbb{R}(\textit{number})$ )`.

**NOTE**  $\mathbb{F}(\text{ToIntegerOrInfinity}(x))$  never returns  $-\mathbf{0}_{\mathbb{F}}$  for any value of *x*. The truncation of the fractional part is performed after converting *x* to a [mathematical value](#).

### 7.1.6 ToInt32 ( *argument* )

The abstract operation ToInt32 takes argument *argument* (an ECMAScript language value) and returns either a normal completion containing an integral Number or a throw completion. It converts *argument* to one of  $2^{32}$  integral Number values in the inclusive interval from  $\mathbb{F}(-2^{31})$  to  $\mathbb{F}(2^{31} - 1)$ . It performs the following steps when called:

1. Let *number* be ? ToNumber(*argument*).
2. If *number* is not finite or *number* is either  $+0_{\mathbb{F}}$  or  $-0_{\mathbb{F}}$ , return  $+0_{\mathbb{F}}$ .
3. Let *int* be truncate( $\mathbb{R}(\textit{number})$ ).
4. Let *int32bit* be *int* modulo  $2^{32}$ .
5. If *int32bit*  $\geq 2^{31}$ , return  $\mathbb{F}(\textit{int32bit} - 2^{32})$ ; otherwise return  $\mathbb{F}(\textit{int32bit})$ .

NOTE Given the above definition of ToInt32:

- The ToInt32 abstract operation is idempotent: if applied to a result that it produced, the second application leaves that value unchanged.
- ToInt32(ToUint32(*x*)) is the same value as ToInt32(*x*) for all values of *x*. (It is to preserve this latter property that  $+\infty_{\mathbb{F}}$  and  $-\infty_{\mathbb{F}}$  are mapped to  $+0_{\mathbb{F}}$ .)
- ToInt32 maps  $-0_{\mathbb{F}}$  to  $+0_{\mathbb{F}}$ .

### 7.1.7 ToUint32 ( *argument* )

The abstract operation ToUint32 takes argument *argument* (an ECMAScript language value) and returns either a normal completion containing an integral Number or a throw completion. It converts *argument* to one of  $2^{32}$  integral Number values in the inclusive interval from  $+0_{\mathbb{F}}$  to  $\mathbb{F}(2^{32} - 1)$ . It performs the following steps when called:

1. Let *number* be ? ToNumber(*argument*).
2. If *number* is not finite or *number* is either  $+0_{\mathbb{F}}$  or  $-0_{\mathbb{F}}$ , return  $+0_{\mathbb{F}}$ .
3. Let *int* be truncate( $\mathbb{R}(\textit{number})$ ).
4. Let *int32bit* be *int* modulo  $2^{32}$ .
5. Return  $\mathbb{F}(\textit{int32bit})$ .

NOTE Given the above definition of ToUint32:

- Step 5 is the only difference between ToUint32 and ToInt32.
- The ToUint32 abstract operation is idempotent: if applied to a result that it produced, the second application leaves that value unchanged.
- ToUint32(ToInt32(*x*)) is the same value as ToUint32(*x*) for all values of *x*. (It is to preserve this latter property that  $+\infty_{\mathbb{F}}$  and  $-\infty_{\mathbb{F}}$  are mapped to  $+0_{\mathbb{F}}$ .)
- ToUint32 maps  $-0_{\mathbb{F}}$  to  $+0_{\mathbb{F}}$ .

### 7.1.8 ToInt16 ( *argument* )

The abstract operation ToInt16 takes argument *argument* (an ECMAScript language value) and returns either a normal completion containing an integral Number or a throw completion. It converts *argument* to one of  $2^{16}$  integral Number values in the inclusive interval from  $\mathbb{F}(-2^{15})$  to  $\mathbb{F}(2^{15} - 1)$ . It performs the following steps when called:

1. Let *number* be ? `ToNumber(argument)`.
2. If *number* is not *finite* or *number* is either  $+0_{\mathbb{F}}$  or  $-0_{\mathbb{F}}$ , return  $+0_{\mathbb{F}}$ .
3. Let *int* be `truncate( $\mathbb{R}(number)$ )`.
4. Let *int16bit* be *int* modulo  $2^{16}$ .
5. If *int16bit*  $\geq 2^{15}$ , return  $\mathbb{F}(int16bit - 2^{16})$ ; otherwise return  $\mathbb{F}(int16bit)$ .

### 7.1.9 ToUint16 ( *argument* )

The abstract operation `ToUint16` takes argument *argument* (an [ECMAScript language value](#)) and returns either a [normal completion](#) containing an [integral Number](#) or a [throw completion](#). It converts *argument* to one of  $2^{16}$  [integral Number](#) values in the [inclusive interval](#) from  $+0_{\mathbb{F}}$  to  $\mathbb{F}(2^{16} - 1)$ . It performs the following steps when called:

1. Let *number* be ? `ToNumber(argument)`.
2. If *number* is not *finite* or *number* is either  $+0_{\mathbb{F}}$  or  $-0_{\mathbb{F}}$ , return  $+0_{\mathbb{F}}$ .
3. Let *int* be `truncate( $\mathbb{R}(number)$ )`.
4. Let *int16bit* be *int* modulo  $2^{16}$ .
5. Return  $\mathbb{F}(int16bit)$ .

NOTE Given the above definition of `ToUint16`:

- The substitution of  $2^{16}$  for  $2^{32}$  in step 4 is the only difference between `ToUint32` and `ToUint16`.
- `ToUint16` maps  $-0_{\mathbb{F}}$  to  $+0_{\mathbb{F}}$ .

### 7.1.10 ToInt8 ( *argument* )

The abstract operation `ToInt8` takes argument *argument* (an [ECMAScript language value](#)) and returns either a [normal completion](#) containing an [integral Number](#) or a [throw completion](#). It converts *argument* to one of  $2^8$  [integral Number](#) values in the [inclusive interval](#) from  $-128_{\mathbb{F}}$  to  $127_{\mathbb{F}}$ . It performs the following steps when called:

1. Let *number* be ? `ToNumber(argument)`.
2. If *number* is not *finite* or *number* is either  $+0_{\mathbb{F}}$  or  $-0_{\mathbb{F}}$ , return  $+0_{\mathbb{F}}$ .
3. Let *int* be `truncate( $\mathbb{R}(number)$ )`.
4. Let *int8bit* be *int* modulo  $2^8$ .
5. If *int8bit*  $\geq 2^7$ , return  $\mathbb{F}(int8bit - 2^8)$ ; otherwise return  $\mathbb{F}(int8bit)$ .

### 7.1.11 ToUint8 ( *argument* )

The abstract operation `ToUint8` takes argument *argument* (an [ECMAScript language value](#)) and returns either a [normal completion](#) containing an [integral Number](#) or a [throw completion](#). It converts *argument* to one of  $2^8$  [integral Number](#) values in the [inclusive interval](#) from  $+0_{\mathbb{F}}$  to  $255_{\mathbb{F}}$ . It performs the following steps when called:

1. Let *number* be ? `ToNumber(argument)`.
2. If *number* is not *finite* or *number* is either  $+0_{\mathbb{F}}$  or  $-0_{\mathbb{F}}$ , return  $+0_{\mathbb{F}}$ .
3. Let *int* be `truncate( $\mathbb{R}(number)$ )`.

4. Let *int8bit* be *int* modulo  $2^8$ .
5. Return  $\mathbb{F}(\textit{int8bit})$ .

### 7.1.12 ToUint8Clamp ( *argument* )

The abstract operation ToUint8Clamp takes argument *argument* (an ECMAScript language value) and returns either a normal completion containing an integral Number or a throw completion. It converts *argument* to one of  $2^8$  integral Number values in the inclusive interval from  $+0_{\mathbb{F}}$  to  $255_{\mathbb{F}}$ . It performs the following steps when called:

1. Let *number* be ? ToNumber(*argument*).
2. If *number* is NaN, return  $+0_{\mathbb{F}}$ .
3. If  $\mathbb{R}(\textit{number}) \leq 0$ , return  $+0_{\mathbb{F}}$ .
4. If  $\mathbb{R}(\textit{number}) \geq 255$ , return  $255_{\mathbb{F}}$ .
5. Let *f* be  $\text{floor}(\mathbb{R}(\textit{number}))$ .
6. If  $f + 0.5 < \mathbb{R}(\textit{number})$ , return  $\mathbb{F}(f + 1)$ .
7. If  $\mathbb{R}(\textit{number}) < f + 0.5$ , return  $\mathbb{F}(f)$ .
8. If *f* is odd, return  $\mathbb{F}(f + 1)$ .
9. Return  $\mathbb{F}(f)$ .

**NOTE** Unlike the other ECMAScript integer conversion abstract operation, ToUint8Clamp rounds rather than truncates non-integral values and does not convert  $+\infty_{\mathbb{F}}$  to  $+0_{\mathbb{F}}$ . ToUint8Clamp does “round half to even” tie-breaking. This differs from **Math.round** which does “round half up” tie-breaking.

### 7.1.13 ToBigInt ( *argument* )

The abstract operation ToBigInt takes argument *argument* (an ECMAScript language value) and returns either a normal completion containing a BigInt or a throw completion. It converts *argument* to a BigInt value, or throws if an implicit conversion from Number would be required. It performs the following steps when called:

1. Let *prim* be ? ToPrimitive(*argument*, number).
2. Return the value that *prim* corresponds to in Table 12.

Table 12: BigInt Conversions

Argument Type	Result
Undefined	Throw a <b>TypeError</b> exception.
Null	Throw a <b>TypeError</b> exception.
Boolean	Return <b>1n</b> if <i>prim</i> is <b>true</b> and <b>0n</b> if <i>prim</i> is <b>false</b> .
BigInt	Return <i>prim</i> .
Number	Throw a <b>TypeError</b> exception.

Table 12 (continued)

Argument Type	Result
String	<ol style="list-style-type: none"> <li>1. Let <math>n</math> be <code>StringToBigInt(<math>prim</math>)</code>.</li> <li>2. If <math>n</math> is <b>undefined</b>, throw a <b>SyntaxError</b> exception.</li> <li>3. Return <math>n</math>.</li> </ol>
Symbol	Throw a <b>TypeError</b> exception.

### 7.1.14 StringToBigInt ( *str* )

The abstract operation StringToBigInt takes argument *str* (a String) and returns a BigInt or **undefined**. It performs the following steps when called:

1. Let *text* be `StringToCodePoints(str)`.
2. Let *literal* be `ParseText(text, StringIntegerLiteral)`.
3. If *literal* is a List of errors, return **undefined**.
4. Let *mv* be the MV of *literal*.
5. **Assert**: *mv* is an integer.
6. Return  $\mathbb{Z}(mv)$ .

#### 7.1.14.1 StringIntegerLiteral Grammar

StringToBigInt uses the following grammar.

##### Syntax

```
StringIntegerLiteral :::
  StrWhiteSpaceopt
  StrWhiteSpaceopt StrIntegerLiteral StrWhiteSpaceopt

StrIntegerLiteral :::
  SignedInteger [~Sep]
  NonDecimalIntegerLiteral [~Sep]
```

#### 7.1.14.2 Runtime Semantics: MV

- The MV of `StringIntegerLiteral ::: StrWhiteSpaceopt` is 0.
- The MV of `StringIntegerLiteral ::: StrWhiteSpaceopt StrIntegerLiteral StrWhiteSpaceopt` is the MV of `StrIntegerLiteral`.

### 7.1.15 ToBigInt64 ( *argument* )

The abstract operation ToBigInt64 takes argument *argument* (an ECMAScript language value) and returns either a **normal completion** containing a BigInt or a **throw completion**. It converts *argument* to one of  $2^{64}$  BigInt values in the **inclusive interval** from  $\mathbb{Z}(-2^{63})$  to  $\mathbb{Z}(2^{63}-1)$ . It performs the following steps when called:

1. Let  $n$  be ? `ToBigInt(argument)`.
2. Let *int64bit* be  $\mathbb{R}(n)$  modulo  $2^{64}$ .

3. If  $int64bit \geq 2^{63}$ , return  $\mathbb{Z}(int64bit - 2^{64})$ ; otherwise return  $\mathbb{Z}(int64bit)$ .

### 7.1.16 ToBigUint64 ( *argument* )

The abstract operation ToBigUint64 takes argument *argument* (an ECMAScript language value) and returns either a normal completion containing a BigInt or a throw completion. It converts *argument* to one of  $2^{64}$  BigInt values in the inclusive interval from  $0_{\mathbb{Z}}$  to  $\mathbb{Z}(2^{64}-1)$ . It performs the following steps when called:

1. Let *n* be ? ToBigInt(*argument*).
2. Let *int64bit* be  $\mathbb{R}(n)$  modulo  $2^{64}$ .
3. Return  $\mathbb{Z}(int64bit)$ .

### 7.1.17 ToString ( *argument* )

The abstract operation ToString takes argument *argument* (an ECMAScript language value) and returns either a normal completion containing a String or a throw completion. It converts *argument* to a value of type String. It performs the following steps when called:

1. If *argument* is a String, return *argument*.
2. If *argument* is a Symbol, throw a **TypeError** exception.
3. If *argument* is **undefined**, return **"undefined"**.
4. If *argument* is **null**, return **"null"**.
5. If *argument* is **true**, return **"true"**.
6. If *argument* is **false**, return **"false"**.
7. If *argument* is a Number, return `Number::toString(argument, 10)`.
8. If *argument* is a BigInt, return `BigInt::toString(argument, 10)`.
9. Assert: *argument* is an Object.
10. Let *primValue* be ? ToPrimitive(*argument*, string).
11. Assert: *primValue* is not an Object.
12. Return ? ToString(*primValue*).

### 7.1.18 ToObject ( *argument* )

The abstract operation ToObject takes argument *argument* (an ECMAScript language value) and returns either a normal completion containing an Object or a throw completion. It converts *argument* to a value of type Object according to Table 13:

Table 13: ToObject Conversions

Argument Type	Result
Undefined	Throw a <b>TypeError</b> exception.
Null	Throw a <b>TypeError</b> exception.
Boolean	Return a new Boolean object whose <code>[[BooleanData]]</code> internal slot is set to <i>argument</i> . See 20.3 for a description of Boolean objects.
Number	Return a new Number object whose <code>[[NumberData]]</code> internal slot is set to <i>argument</i> . See 21.1 for a description of Number objects.

Table 13 (continued)

Argument Type	Result
Symbol	Return a new Symbol object whose [[SymbolData]] internal slot is set to <i>argument</i> . See 20.4 for a description of Symbol objects.
BigInt	Return a new BigInt object whose [[BigIntData]] internal slot is set to <i>argument</i> . See 21.2 for a description of BigInt objects.
Object	Return <i>argument</i> .

### 7.1.19 ToPropertyKey ( *argument* )

The abstract operation ToPropertyKey takes argument *argument* (an ECMAScript language value) and returns either a normal completion containing a property key or a throw completion. It converts *argument* to a value that can be used as a property key. It performs the following steps when called:

1. Let *key* be ? ToPrimitive(*argument*, string).
2. If *key* is a Symbol, then
  - a. Return *key*.
3. Return ! ToString(*key*).

### 7.1.20 ToLength ( *argument* )

The abstract operation ToLength takes argument *argument* (an ECMAScript language value) and returns either a normal completion containing an integral Number or a throw completion. It clamps *argument* to an integral Number suitable for use as the length of an array-like object. It performs the following steps when called:

1. Let *len* be ? ToIntegerOrInfinity(*argument*).
2. If  $len \leq 0$ , return +0<sub>F</sub>.
3. Return  $\mathbb{F}(\min(len, 2^{53} - 1))$ .

### 7.1.21 CanonicalNumericIndexString ( *argument* )

The abstract operation CanonicalNumericIndexString takes argument *argument* (a String) and returns a Number or **undefined**. If *argument* is either "-0" or exactly matches the result of ToString(*n*) for some Number value *n*, it returns the respective Number value. Otherwise, it returns **undefined**. It performs the following steps when called:

1. If *argument* is "-0", return -0<sub>F</sub>.
2. Let *n* be ! ToNumber(*argument*).
3. If ! ToString(*n*) is *argument*, return *n*.
4. Return **undefined**.

A *canonical numeric string* is any String value for which the CanonicalNumericIndexString abstract operation does not return **undefined**.

### 7.1.22 ToIndex ( *value* )

The abstract operation ToIndex takes argument *value* (an ECMAScript language value) and returns either a normal completion containing a non-negative integer or a throw completion. It converts *value* to a non-negative integer if the corresponding decimal representation, as a String, is an integer index. It performs the following steps when called:

1. If *value* is **undefined**, then
  - a. Return 0.
2. Else,
  - a. Let *integer* be ? `ToIntegerOrInfinity`(*value*).
  - b. Let *clamped* be ! `ToLength`(`ℱ`(*integer*)).
  - c. If `SameValue`(`ℱ`(*integer*), *clamped*) is **false**, throw a **RangeError** exception.
  - d. **Assert**:  $0 \leq \textit{integer} \leq 2^{53} - 1$ .
  - e. Return *integer*.

## 7.2 Testing and Comparison Operations

### 7.2.1 RequireObjectCoercible ( *argument* )

The abstract operation `RequireObjectCoercible` takes argument *argument* (an ECMAScript language value) and returns either a **normal completion** containing an ECMAScript language value or a **throw completion**. It throws an error if *argument* is a value that cannot be converted to an Object using `ToObject`. It is defined by Table 14:

Table 14: `RequireObjectCoercible` Results

Argument Type	Result
Undefined	Throw a <b>TypeError</b> exception.
Null	Throw a <b>TypeError</b> exception.
Boolean	Return <i>argument</i> .
Number	Return <i>argument</i> .
String	Return <i>argument</i> .
Symbol	Return <i>argument</i> .
BigInt	Return <i>argument</i> .
Object	Return <i>argument</i> .

### 7.2.2 IsArray ( *argument* )

The abstract operation `IsArray` takes argument *argument* (an ECMAScript language value) and returns either a **normal completion** containing a Boolean or a **throw completion**. It performs the following steps when called:

1. If *argument* is not an Object, return **false**.
2. If *argument* is an Array exotic object, return **true**.
3. If *argument* is a Proxy exotic object, then
  - a. Perform ? `ValidateNonRevokedProxy`(*argument*).
  - b. Let *proxyTarget* be *argument*.[[ProxyTarget]].
  - c. Return ? `IsArray`(*proxyTarget*).
4. Return **false**.



### 7.2.3 IsCallable ( *argument* )

The abstract operation IsCallable takes argument *argument* (an [ECMAScript language value](#)) and returns a Boolean. It determines if *argument* is a callable function with a `[[Call]]` internal method. It performs the following steps when called:

1. If *argument* is not an Object, return **false**.
2. If *argument* has a `[[Call]]` internal method, return **true**.
3. Return **false**.

### 7.2.4 IsConstructor ( *argument* )

The abstract operation IsConstructor takes argument *argument* (an [ECMAScript language value](#)) and returns a Boolean. It determines if *argument* is a [function object](#) with a `[[Construct]]` internal method. It performs the following steps when called:

1. If *argument* is not an Object, return **false**.
2. If *argument* has a `[[Construct]]` internal method, return **true**.
3. Return **false**.

### 7.2.5 IsExtensible ( *O* )

The abstract operation IsExtensible takes argument *O* (an Object) and returns either a [normal completion containing](#) a Boolean or a [throw completion](#). It is used to determine whether additional properties can be added to *O*. It performs the following steps when called:

1. Return ? *O*.`[[IsExtensible]]`()().

### 7.2.6 IsIntegralNumber ( *argument* )

The abstract operation IsIntegralNumber takes argument *argument* (an [ECMAScript language value](#)) and returns a Boolean. It determines if *argument* is a [finite integral Number](#) value. It performs the following steps when called:

1. If *argument* is not a Number, return **false**.
2. If *argument* is not finite, return **false**.
3. If `truncate( $\mathbb{R}$ (argument))`  $\neq$   `$\mathbb{R}$ (argument)`, return **false**.
4. Return **true**.

### 7.2.7 IsPropertyKey ( *argument* )

The abstract operation IsPropertyKey takes argument *argument* (an [ECMAScript language value](#)) and returns a Boolean. It determines if *argument* is a value that may be used as a [property key](#). It performs the following steps when called:

1. If *argument* is a String, return **true**.
2. If *argument* is a Symbol, return **true**.
3. Return **false**.

## 7.2.8 IsRegExp ( *argument* )

The abstract operation IsRegExp takes argument *argument* (an [ECMAScript language value](#)) and returns either a [normal completion containing](#) a Boolean or a [throw completion](#). It performs the following steps when called:

1. If *argument* is not an Object, return **false**.
2. Let *matcher* be ? [Get](#)(*argument*, @@match).
3. If *matcher* is not **undefined**, return [ToBoolean](#)(*matcher*).
4. If *argument* has a [[RegExpMatcher]] internal slot, return **true**.
5. Return **false**.

## 7.2.9 Static Semantics: IsStringWellFormedUnicode ( *string* )

The abstract operation IsStringWellFormedUnicode takes argument *string* (a String) and returns a Boolean. It interprets *string* as a sequence of UTF-16 encoded code points, as described in [6.1.4](#), and determines whether it is a [well formed](#) UTF-16 sequence. It performs the following steps when called:

1. Let *len* be the length of *string*.
2. Let *k* be 0.
3. Repeat, while *k* < *len*,
  - a. Let *cp* be [CodePointAt](#)(*string*, *k*).
  - b. If *cp*.[[IsUnpairedSurrogate]] is **true**, return **false**.
  - c. Set *k* to *k* + *cp*.[[CodeUnitCount]].
4. Return **true**.

## 7.2.10 SameValue ( *x*, *y* )

The abstract operation SameValue takes arguments *x* (an [ECMAScript language value](#)) and *y* (an [ECMAScript language value](#)) and returns a Boolean. It determines whether or not the two arguments are the same value. It performs the following steps when called:

1. If [Type](#)(*x*) is not [Type](#)(*y*), return **false**.
2. If *x* is a Number, then
  - a. Return [Number::sameValue](#)(*x*, *y*).
3. Return [SameValueNonNumber](#)(*x*, *y*).

**NOTE** This algorithm differs from the [IsStrictlyEqual](#) Algorithm by treating all **NaN** values as equivalent and by differentiating **+0<sub>F</sub>** from **-0<sub>F</sub>**.

## 7.2.11 SameValueZero ( *x*, *y* )

The abstract operation SameValueZero takes arguments *x* (an [ECMAScript language value](#)) and *y* (an [ECMAScript language value](#)) and returns a Boolean. It determines whether or not the two arguments are the same value (ignoring the difference between **+0<sub>F</sub>** and **-0<sub>F</sub>**). It performs the following steps when called:

1. If [Type](#)(*x*) is not [Type](#)(*y*), return **false**.
2. If *x* is a Number, then
  - a. Return [Number::sameValueZero](#)(*x*, *y*).
3. Return [SameValueNonNumber](#)(*x*, *y*).

NOTE SameValueZero differs from [SameValue](#) only in that it treats  $+0_{\text{F}}$  and  $-0_{\text{F}}$  as equivalent.

### 7.2.12 SameValueNonNumber ( *x*, *y* )

The abstract operation SameValueNonNumber takes arguments *x* (an [ECMAScript language value](#), but not a Number) and *y* (an [ECMAScript language value](#), but not a Number) and returns a Boolean. It performs the following steps when called:

1. Assert: [Type](#)(*x*) is [Type](#)(*y*).
2. If *x* is either **null** or **undefined**, return **true**.
3. If *x* is a [BigInt](#), then
  - a. Return [BigInt::equal](#)(*x*, *y*).
4. If *x* is a [String](#), then
  - a. If *x* and *y* have the same length and the same code units in the same positions, return **true**; otherwise, return **false**.
5. If *x* is a [Boolean](#), then
  - a. If *x* and *y* are both **true** or both **false**, return **true**; otherwise, return **false**.
6. NOTE: All other [ECMAScript language values](#) are compared by identity.
7. If *x* is *y*, return **true**; otherwise, return **false**.

NOTE 1 For expository purposes, some cases are handled separately within this algorithm even if it is unnecessary to do so.

NOTE 2 The specifics of what "*x* is *y*" means are detailed in [5.2.7](#).

### 7.2.13 IsLessThan ( *x*, *y*, *LeftFirst* )

The abstract operation IsLessThan takes arguments *x* (an [ECMAScript language value](#)), *y* (an [ECMAScript language value](#)), and *LeftFirst* (a Boolean) and returns either a [normal completion](#) containing either a Boolean or **undefined**, or a [throw completion](#). It provides the semantics for the comparison  $x < y$ , returning **true**, **false**, or **undefined** (which indicates that at least one operand is **NaN**). The *LeftFirst* flag is used to control the order in which operations with potentially visible side-effects are performed upon *x* and *y*. It is necessary because ECMAScript specifies left to right evaluation of expressions. If *LeftFirst* is **true**, the *x* parameter corresponds to an expression that occurs to the left of the *y* parameter's corresponding expression. If *LeftFirst* is **false**, the reverse is the case and operations must be performed upon *y* before *x*. It performs the following steps when called:

1. If *LeftFirst* is **true**, then
  - a. Let *px* be ? [ToPrimitive](#)(*x*, number).
  - b. Let *py* be ? [ToPrimitive](#)(*y*, number).
2. Else,
  - a. NOTE: The order of evaluation needs to be reversed to preserve left to right evaluation.
  - b. Let *py* be ? [ToPrimitive](#)(*y*, number).
  - c. Let *px* be ? [ToPrimitive](#)(*x*, number).
3. If *px* is a [String](#) and *py* is a [String](#), then
  - a. Let *lx* be the length of *px*.
  - b. Let *ly* be the length of *py*.
  - c. For each [integer](#) *i* such that  $0 \leq i < \min(lx, ly)$ , in ascending order, do
    - i. Let *cx* be the numeric value of the code unit at index *i* within *px*.

- ii. Let  $cy$  be the numeric value of the code unit at index  $i$  within  $py$ .
      - iii. If  $cx < cy$ , return **true**.
      - iv. If  $cx > cy$ , return **false**.
    - d. If  $lx < ly$ , return **true**. Otherwise, return **false**.
- 4. Else,
  - a. If  $px$  is a **BigInt** and  $py$  is a **String**, then
    - i. Let  $ny$  be `StringToBigInt(py)`.
    - ii. If  $ny$  is **undefined**, return **undefined**.
    - iii. Return `BigInt::lessThan(px, ny)`.
  - b. If  $px$  is a **String** and  $py$  is a **BigInt**, then
    - i. Let  $nx$  be `StringToBigInt(px)`.
    - ii. If  $nx$  is **undefined**, return **undefined**.
    - iii. Return `BigInt::lessThan(nx, py)`.
  - c. NOTE: Because  $px$  and  $py$  are primitive values, evaluation order is not important.
  - d. Let  $nx$  be `? ToNumeric(px)`.
  - e. Let  $ny$  be `? ToNumeric(py)`.
  - f. If `Type(nx)` is `Type(ny)`, then
    - i. If  $nx$  is a **Number**, then
      - 1. Return `Number::lessThan(nx, ny)`.
    - ii. Else,
      - 1. Assert:  $nx$  is a **BigInt**.
      - 2. Return `BigInt::lessThan(nx, ny)`.
  - g. Assert:  $nx$  is a **BigInt** and  $ny$  is a **Number**, or  $nx$  is a **Number** and  $ny$  is a **BigInt**.
  - h. If  $nx$  or  $ny$  is **NaN**, return **undefined**.
  - i. If  $nx$  is  $-\infty_{\mathbb{F}}$  or  $ny$  is  $+\infty_{\mathbb{F}}$ , return **true**.
  - j. If  $nx$  is  $+\infty_{\mathbb{F}}$  or  $ny$  is  $-\infty_{\mathbb{F}}$ , return **false**.
  - k. If  $\mathbb{R}(nx) < \mathbb{R}(ny)$ , return **true**; otherwise return **false**.

NOTE 1 Step 3 differs from step 1.c in the algorithm that handles the addition operator + (13.15.3) by using the logical-and operation instead of the logical-or operation.

NOTE 2 The comparison of Strings uses a simple lexicographic ordering on sequences of UTF-16 code unit values. There is no attempt to use the more complex, semantically oriented definitions of character or string equality and collating order defined in the Unicode specification. Therefore String values that are canonically equal according to the Unicode Standard but not in the same normalization form could test as unequal. Also note that lexicographic ordering by *code unit* differs from ordering by *code point* for Strings containing *surrogate pairs*.

## 7.2.14 IsLooselyEqual ( $x$ , $y$ )

The abstract operation `IsLooselyEqual` takes arguments  $x$  (an [ECMAScript language value](#)) and  $y$  (an [ECMAScript language value](#)) and returns either a [normal completion containing](#) a Boolean or a [throw completion](#). It provides the semantics for the `==` operator. It performs the following steps when called:

1. If `Type(x)` is `Type(y)`, then
  - a. Return `IsStrictlyEqual(x, y)`.
2. If  $x$  is **null** and  $y$  is **undefined**, return **true**.
3. If  $x$  is **undefined** and  $y$  is **null**, return **true**.
4. NOTE: This step is replaced in section [B.3.6.2](#).

5. If  $x$  is a [Number](#) and  $y$  is a [String](#), return ! [IsLooselyEqual](#)( $x$ , ! [ToNumber](#)( $y$ )).
6. If  $x$  is a [String](#) and  $y$  is a [Number](#), return ! [IsLooselyEqual](#)(! [ToNumber](#)( $x$ ),  $y$ ).
7. If  $x$  is a [BigInt](#) and  $y$  is a [String](#), then
  - a. Let  $n$  be [StringToBigInt](#)( $y$ ).
  - b. If  $n$  is **undefined**, return **false**.
  - c. Return ! [IsLooselyEqual](#)( $x$ ,  $n$ ).
8. If  $x$  is a [String](#) and  $y$  is a [BigInt](#), return ! [IsLooselyEqual](#)( $y$ ,  $x$ ).
9. If  $x$  is a [Boolean](#), return ! [IsLooselyEqual](#)(! [ToNumber](#)( $x$ ),  $y$ ).
10. If  $y$  is a [Boolean](#), return ! [IsLooselyEqual](#)( $x$ , ! [ToNumber](#)( $y$ )).
11. If  $x$  is either a [String](#), a [Number](#), a [BigInt](#), or a [Symbol](#) and  $y$  is an [Object](#), return ! [IsLooselyEqual](#)( $x$ , ? [ToPrimitive](#)( $y$ )).
12. If  $x$  is an [Object](#) and  $y$  is either a [String](#), a [Number](#), a [BigInt](#), or a [Symbol](#), return ! [IsLooselyEqual](#)(? [ToPrimitive](#)( $x$ ),  $y$ ).
13. If  $x$  is a [BigInt](#) and  $y$  is a [Number](#), or if  $x$  is a [Number](#) and  $y$  is a [BigInt](#), then
  - a. If  $x$  is not [finite](#) or  $y$  is not [finite](#), return **false**.
  - b. If  $\mathbb{R}(x) = \mathbb{R}(y)$ , return **true**; otherwise return **false**.
14. Return **false**.

### 7.2.15 IsStrictlyEqual ( $x$ , $y$ )

The abstract operation [IsStrictlyEqual](#) takes arguments  $x$  (an [ECMAScript language value](#)) and  $y$  (an [ECMAScript language value](#)) and returns a Boolean. It provides the semantics for the `===` operator. It performs the following steps when called:

1. If [Type](#)( $x$ ) is not [Type](#)( $y$ ), return **false**.
2. If  $x$  is a [Number](#), then
  - a. Return [Number::equal](#)( $x$ ,  $y$ ).
3. Return [SameValueNonNumber](#)( $x$ ,  $y$ ).

NOTE This algorithm differs from the [SameValue](#) Algorithm in its treatment of signed zeroes and NaNs.

## 7.3 Operations on Objects

### 7.3.1 MakeBasicObject ( *internalSlotsList* )

The abstract operation [MakeBasicObject](#) takes argument *internalSlotsList* (a [List](#) of internal slot names) and returns an [Object](#). It is the source of all [ECMAScript objects](#) that are created algorithmically, including both [ordinary objects](#) and [exotic objects](#). It factors out common steps used in creating all objects, and centralizes object creation. It performs the following steps when called:

1. Let *obj* be a newly created object with an internal slot for each name in *internalSlotsList*.
2. Set *obj*'s essential internal methods to the default [ordinary object](#) definitions specified in [10.1](#).
3. **Assert**: If the caller will not be overriding both *obj*'s [\[\[GetPrototypeOf\]\]](#) and [\[\[SetPrototypeOf\]\]](#) essential internal methods, then *internalSlotsList* contains [\[\[Prototype\]\]](#).
4. **Assert**: If the caller will not be overriding all of *obj*'s [\[\[SetPrototypeOf\]\]](#), [\[\[IsExtensible\]\]](#), and [\[\[PreventExtensions\]\]](#) essential internal methods, then *internalSlotsList* contains [\[\[Extensible\]\]](#).
5. If *internalSlotsList* contains [\[\[Extensible\]\]](#), set *obj*.[\[\[Extensible\]\]](#) to **true**.
6. Return *obj*.

NOTE Within this specification, **exotic objects** are created in **abstract operations** such as **ArrayCreate** and **BoundFunctionCreate** by first calling **MakeBasicObject** to obtain a basic, foundational object, and then overriding some or all of that object's internal methods. In order to encapsulate **exotic object** creation, the object's essential internal methods are never modified outside those operations.

### 7.3.2 Get ( *O*, *P* )

The abstract operation **Get** takes arguments *O* (an Object) and *P* (a **property key**) and returns either a **normal completion containing** an **ECMAScript language value** or a **throw completion**. It is used to retrieve the value of a specific property of an object. It performs the following steps when called:

1. Return ? *O*.[[Get]](*P*, *O*).

### 7.3.3 GetV ( *V*, *P* )

The abstract operation **GetV** takes arguments *V* (an **ECMAScript language value**) and *P* (a **property key**) and returns either a **normal completion containing** an **ECMAScript language value** or a **throw completion**. It is used to retrieve the value of a specific property of an **ECMAScript language value**. If the value is not an object, the property lookup is performed using a wrapper object appropriate for the type of the value. It performs the following steps when called:

1. Let *O* be ? **ToObject**(*V*).
2. Return ? *O*.[[Get]](*P*, *V*).

### 7.3.4 Set ( *O*, *P*, *V*, *Throw* )

The abstract operation **Set** takes arguments *O* (an Object), *P* (a **property key**), *V* (an **ECMAScript language value**), and *Throw* (a Boolean) and returns either a **normal completion containing** unused or a **throw completion**. It is used to set the value of a specific property of an object. *V* is the new value for the property. It performs the following steps when called:

1. Let *success* be ? *O*.[[Set]](*P*, *V*, *O*).
2. If *success* is **false** and *Throw* is **true**, throw a **TypeError** exception.
3. Return unused.

### 7.3.5 CreateDataProperty ( *O*, *P*, *V* )

The abstract operation **CreateDataProperty** takes arguments *O* (an Object), *P* (a **property key**), and *V* (an **ECMAScript language value**) and returns either a **normal completion containing** a Boolean or a **throw completion**. It is used to create a new own property of an object. It performs the following steps when called:

1. Let *newDesc* be the **PropertyDescriptor** { [[Value]]: *V*, [[Writable]]: **true**, [[Enumerable]]: **true**, [[Configurable]]: **true** }.
2. Return ? *O*.[[DefineOwnProperty]](*P*, *newDesc*).

NOTE This abstract operation creates a property whose attributes are set to the same defaults used for properties created by the ECMAScript language assignment operator. Normally, the property will not already exist. If it does exist and is not configurable or if *O* is not extensible, [[DefineOwnProperty]] will return **false**.

### 7.3.6 CreateMethodProperty ( *O*, *P*, *V* )

The abstract operation CreateMethodProperty takes arguments *O* (an Object), *P* (a [property key](#)), and *V* (an [ECMAScript language value](#)) and returns unused. It is used to create a new own property of an [ordinary object](#). It performs the following steps when called:

1. **Assert**: *O* is an ordinary, extensible object with no non-configurable properties.
2. Let *newDesc* be the PropertyDescriptor { **[[Value]]**: *V*, **[[Writable]]**: **true**, **[[Enumerable]]**: **false**, **[[Configurable]]**: **true** }.
3. Perform ! [DefinePropertyOrThrow](#)(*O*, *P*, *newDesc*).
4. Return unused.

**NOTE** This abstract operation creates a property whose attributes are set to the same defaults used for built-in methods and methods defined using class declaration syntax. Normally, the property will not already exist. If it does exist, [DefinePropertyOrThrow](#) is guaranteed to complete normally.

### 7.3.7 CreateDataPropertyOrThrow ( *O*, *P*, *V* )

The abstract operation CreateDataPropertyOrThrow takes arguments *O* (an Object), *P* (a [property key](#)), and *V* (an [ECMAScript language value](#)) and returns either a [normal completion containing](#) unused or a [throw completion](#). It is used to create a new own property of an object. It throws a **TypeError** exception if the requested property update cannot be performed. It performs the following steps when called:

1. Let *success* be ? [CreateDataProperty](#)(*O*, *P*, *V*).
2. If *success* is **false**, throw a **TypeError** exception.
3. Return unused.

**NOTE** This abstract operation creates a property whose attributes are set to the same defaults used for properties created by the ECMAScript language assignment operator. Normally, the property will not already exist. If it does exist and is not configurable or if *O* is not extensible, **[[DefineOwnProperty]]** will return **false** causing this operation to throw a **TypeError** exception.

### 7.3.8 CreateNonEnumerableDataPropertyOrThrow ( *O*, *P*, *V* )

The abstract operation CreateNonEnumerableDataPropertyOrThrow takes arguments *O* (an Object), *P* (a [property key](#)), and *V* (an [ECMAScript language value](#)) and returns unused. It is used to create a new non-enumerable own property of an [ordinary object](#). It performs the following steps when called:

1. **Assert**: *O* is an ordinary, extensible object with no non-configurable properties.
2. Let *newDesc* be the PropertyDescriptor { **[[Value]]**: *V*, **[[Writable]]**: **true**, **[[Enumerable]]**: **false**, **[[Configurable]]**: **true** }.
3. Perform ! [DefinePropertyOrThrow](#)(*O*, *P*, *newDesc*).
4. Return unused.

**NOTE** This abstract operation creates a property whose attributes are set to the same defaults used for properties created by the ECMAScript language assignment operator except it is not enumerable. Normally, the property will not already exist. If it does exist, [DefinePropertyOrThrow](#) is guaranteed to complete normally.

### 7.3.9 DefinePropertyOrThrow ( *O*, *P*, *desc* )

The abstract operation DefinePropertyOrThrow takes arguments *O* (an Object), *P* (a [property key](#)), and *desc* (a [Property Descriptor](#)) and returns either a [normal completion containing](#) unused or a [throw completion](#). It is used to call the `[[DefineOwnProperty]]` internal method of an object in a manner that will throw a **TypeError** exception if the requested property update cannot be performed. It performs the following steps when called:

1. Let *success* be ? *O*.`[[DefineOwnProperty]]`(*P*, *desc*).
2. If *success* is **false**, throw a **TypeError** exception.
3. Return unused.

### 7.3.10 DeletePropertyOrThrow ( *O*, *P* )

The abstract operation DeletePropertyOrThrow takes arguments *O* (an Object) and *P* (a [property key](#)) and returns either a [normal completion containing](#) unused or a [throw completion](#). It is used to remove a specific own property of an object. It throws an exception if the property is not configurable. It performs the following steps when called:

1. Let *success* be ? *O*.`[[Delete]]`(*P*).
2. If *success* is **false**, throw a **TypeError** exception.
3. Return unused.

### 7.3.11 GetMethod ( *V*, *P* )

The abstract operation GetMethod takes arguments *V* (an [ECMAScript language value](#)) and *P* (a [property key](#)) and returns either a [normal completion containing](#) either a [function object](#) or **undefined**, or a [throw completion](#). It is used to get the value of a specific property of an [ECMAScript language value](#) when the value of the property is expected to be a function. It performs the following steps when called:

1. Let *func* be ? *GetV*(*V*, *P*).
2. If *func* is either **undefined** or **null**, return **undefined**.
3. If `IsCallable(func)` is **false**, throw a **TypeError** exception.
4. Return *func*.

### 7.3.12 HasProperty ( *O*, *P* )

The abstract operation HasProperty takes arguments *O* (an Object) and *P* (a [property key](#)) and returns either a [normal completion containing](#) a Boolean or a [throw completion](#). It is used to determine whether an object has a property with the specified [property key](#). The property may be either own or inherited. It performs the following steps when called:

1. Return ? *O*.`[[HasProperty]]`(*P*).

### 7.3.13 HasOwnProperty ( *O*, *P* )

The abstract operation HasOwnProperty takes arguments *O* (an Object) and *P* (a [property key](#)) and returns either a [normal completion containing](#) a Boolean or a [throw completion](#). It is used to determine whether an object has an own property with the specified [property key](#). It performs the following steps when called:

1. Let *desc* be ? *O*.`[[GetOwnProperty]]`(*P*).
2. If *desc* is **undefined**, return **false**.
3. Return **true**.



### 7.3.14 Call ( *F*, *V* [ , *argumentsList* ] )

The abstract operation Call takes arguments *F* (an ECMAScript language value) and *V* (an ECMAScript language value) and optional argument *argumentsList* (a List of ECMAScript language values) and returns either a normal completion containing an ECMAScript language value or a throw completion. It is used to call the `[[Call]]` internal method of a function object. *F* is the function object, *V* is an ECMAScript language value that is the **this** value of the `[[Call]]`, and *argumentsList* is the value passed to the corresponding argument of the internal method. If *argumentsList* is not present, a new empty List is used as its value. It performs the following steps when called:

1. If *argumentsList* is not present, set *argumentsList* to a new empty List.
2. If `IsCallable(F)` is **false**, throw a **TypeError** exception.
3. Return ? *F*.`[[Call]]`(*V*, *argumentsList*).

### 7.3.15 Construct ( *F* [ , *argumentsList* [ , *newTarget* ] ] )

The abstract operation Construct takes argument *F* (a constructor) and optional arguments *argumentsList* (a List of ECMAScript language values) and *newTarget* (a constructor) and returns either a normal completion containing an Object or a throw completion. It is used to call the `[[Construct]]` internal method of a function object. *argumentsList* and *newTarget* are the values to be passed as the corresponding arguments of the internal method. If *argumentsList* is not present, a new empty List is used as its value. If *newTarget* is not present, *F* is used as its value. It performs the following steps when called:

1. If *newTarget* is not present, set *newTarget* to *F*.
2. If *argumentsList* is not present, set *argumentsList* to a new empty List.
3. Return ? *F*.`[[Construct]]`(*argumentsList*, *newTarget*).

**NOTE** If *newTarget* is not present, this operation is equivalent to: `new F(...argumentsList)`

### 7.3.16 SetIntegrityLevel ( *O*, *level* )

The abstract operation SetIntegrityLevel takes arguments *O* (an Object) and *level* (sealed or frozen) and returns either a normal completion containing a Boolean or a throw completion. It is used to fix the set of own properties of an object. It performs the following steps when called:

1. Let *status* be ? *O*.`[[PreventExtensions]]`().
2. If *status* is **false**, return **false**.
3. Let *keys* be ? *O*.`[[OwnPropertyKeys]]`().
4. If *level* is sealed, then
  - a. For each element *k* of *keys*, do
    - i. Perform ? `DefinePropertyOrThrow`(*O*, *k*, `PropertyDescriptor` { `[[Configurable]]`: **false** }).
5. Else,
  - a. **Assert**: *level* is frozen.
  - b. For each element *k* of *keys*, do
    - i. Let *currentDesc* be ? *O*.`[[GetOwnProperty]]`(*k*).
    - ii. If *currentDesc* is not **undefined**, then
      1. If `IsAccessorDescriptor`(*currentDesc*) is **true**, then
        - a. Let *desc* be the `PropertyDescriptor` { `[[Configurable]]`: **false** }.
      2. Else,
        - a. Let *desc* be the `PropertyDescriptor` { `[[Configurable]]`: **false**, `[[Writable]]`: **false** }.

3. Perform ? `DefinePropertyOrThrow`(*O*, *k*, *desc*).
6. Return **true**.

### 7.3.17 TestIntegrityLevel ( *O*, *level* )

The abstract operation TestIntegrityLevel takes arguments *O* (an Object) and *level* (sealed or frozen) and returns either a [normal completion containing](#) a Boolean or a [throw completion](#). It is used to determine if the set of own properties of an object are fixed. It performs the following steps when called:

1. Let *extensible* be ? `IsExtensible`(*O*).
2. If *extensible* is **true**, return **false**.
3. NOTE: If the object is extensible, none of its properties are examined.
4. Let *keys* be ? `O`.[[OwnPropertyKeys]]().
5. For each element *k* of *keys*, do
  - a. Let *currentDesc* be ? `O`.[[GetOwnProperty]](*k*).
  - b. If *currentDesc* is not **undefined**, then
    - i. If *currentDesc*.[[Configurable]] is **true**, return **false**.
    - ii. If *level* is frozen and `IsDataDescriptor`(*currentDesc*) is **true**, then
      1. If *currentDesc*.[[Writable]] is **true**, return **false**.
6. Return **true**.

### 7.3.18 CreateArrayFromList ( *elements* )

The abstract operation CreateArrayFromList takes argument *elements* (a List of ECMAScript language values) and returns an Array. It is used to create an Array whose elements are provided by *elements*. It performs the following steps when called:

1. Let *array* be ! `ArrayCreate`(0).
2. Let *n* be 0.
3. For each element *e* of *elements*, do
  - a. Perform ! `CreateDataPropertyOrThrow`(*array*, ! `ToString`(*F*(*n*)), *e*).
  - b. Set *n* to *n* + 1.
4. Return *array*.

### 7.3.19 LengthOfArrayLike ( *obj* )

The abstract operation LengthOfArrayLike takes argument *obj* (an Object) and returns either a [normal completion containing](#) a non-negative integer or a [throw completion](#). It returns the value of the "length" property of an array-like object. It performs the following steps when called:

1. Return  $\mathbb{R}$ (? `ToLength`(? `Get`(*obj*, "length"))).

An *array-like object* is any object for which this operation returns a [normal completion](#).

NOTE 1 Typically, an array-like object would also have some properties with [integer index](#) names. However, that is not a requirement of this definition.

NOTE 2 Arrays and String objects are examples of array-like objects.

### 7.3.20 CreateListFromArrayLike ( *obj* [ , *elementTypes* ] )

The abstract operation CreateListFromArrayLike takes argument *obj* (an ECMAScript language value) and optional argument *elementTypes* (a List of names of ECMAScript Language Types) and returns either a normal completion containing a List of ECMAScript language values or a throw completion. It is used to create a List value whose elements are provided by the indexed properties of *obj*. *elementTypes* contains the names of ECMAScript Language Types that are allowed for element values of the List that is created. It performs the following steps when called:

1. If *elementTypes* is not present, set *elementTypes* to « Undefined, Null, Boolean, String, Symbol, Number, BigInt, Object ».
2. If *obj* is not an Object, throw a **TypeError** exception.
3. Let *len* be ? LengthOfArrayLike(*obj*).
4. Let *list* be a new empty List.
5. Let *index* be 0.
6. Repeat, while *index* < *len*,
  - a. Let *indexName* be ! ToString(F(*index*)).
  - b. Let *next* be ? Get(*obj*, *indexName*).
  - c. If *elementTypes* does not contain Type(*next*), throw a **TypeError** exception.
  - d. Append *next* to *list*.
  - e. Set *index* to *index* + 1.
7. Return *list*.

### 7.3.21 Invoke ( *V*, *P* [ , *argumentsList* ] )

The abstract operation Invoke takes arguments *V* (an ECMAScript language value) and *P* (a property key) and optional argument *argumentsList* (a List of ECMAScript language values) and returns either a normal completion containing an ECMAScript language value or a throw completion. It is used to call a method property of an ECMAScript language value. *V* serves as both the lookup point for the property and the **this** value of the call. *argumentsList* is the list of arguments values passed to the method. If *argumentsList* is not present, a new empty List is used as its value. It performs the following steps when called:

1. If *argumentsList* is not present, set *argumentsList* to a new empty List.
2. Let *func* be ? GetV(*V*, *P*).
3. Return ? Call(*func*, *V*, *argumentsList*).

### 7.3.22 OrdinaryHasInstance ( *C*, *O* )

The abstract operation OrdinaryHasInstance takes arguments *C* (an ECMAScript language value) and *O* (an ECMAScript language value) and returns either a normal completion containing a Boolean or a throw completion. It implements the default algorithm for determining if *O* inherits from the instance object inheritance path provided by *C*. It performs the following steps when called:

1. If IsCallable(*C*) is **false**, return **false**.
2. If *C* has a [[BoundTargetFunction]] internal slot, then
  - a. Let *BC* be C.[[BoundTargetFunction]].
  - b. Return ? InstanceofOperator(*O*, *BC*).
3. If *O* is not an Object, return **false**.
4. Let *P* be ? Get(*C*, "prototype").
5. If *P* is not an Object, throw a **TypeError** exception.
6. Repeat,
  - a. Set *O* to ? O.[[GetPrototypeOf]]().

- b. If *O* is **null**, return **false**.
- c. If `SameValue(P, O)` is **true**, return **true**.

### 7.3.23 SpeciesConstructor ( *O*, *defaultConstructor* )

The abstract operation SpeciesConstructor takes arguments *O* (an Object) and *defaultConstructor* (a constructor) and returns either a normal completion containing a constructor or a throw completion. It is used to retrieve the constructor that should be used to create new objects that are derived from *O*. *defaultConstructor* is the constructor to use if a `@@species` property cannot be found starting from *O*. It performs the following steps when called:

1. Let *C* be ? `Get(O, "constructor")`.
2. If *C* is **undefined**, return *defaultConstructor*.
3. If *C* is not an Object, throw a **TypeError** exception.
4. Let *S* be ? `Get(C, @@species)`.
5. If *S* is either **undefined** or **null**, return *defaultConstructor*.
6. If `IsConstructor(S)` is **true**, return *S*.
7. Throw a **TypeError** exception.

### 7.3.24 EnumerableOwnProperties ( *O*, *kind* )

The abstract operation EnumerableOwnProperties takes arguments *O* (an Object) and *kind* (key, value, or key+value) and returns either a normal completion containing a List of ECMAScript language values or a throw completion. It performs the following steps when called:

1. Let *ownKeys* be ? `O.[[OwnPropertyKeys]]()`.
2. Let *results* be a new empty List.
3. For each element *key* of *ownKeys*, do
  - a. If *key* is a String, then
    - i. Let *desc* be ? `O.[[GetOwnProperty]](key)`.
    - ii. If *desc* is not **undefined** and `desc.[[Enumerable]]` is **true**, then
      1. If *kind* is key, append *key* to *results*.
      2. Else,
        - a. Let *value* be ? `Get(O, key)`.
        - b. If *kind* is value, append *value* to *results*.
        - c. Else,
          - i. **Assert**: *kind* is key+value.
          - ii. Let *entry* be `CreateArrayFromList(« key, value »)`.
          - iii. Append *entry* to *results*.
4. Return *results*.

### 7.3.25 GetFunctionRealm ( *obj* )

The abstract operation GetFunctionRealm takes argument *obj* (a function object) and returns either a normal completion containing a Realm Record or a throw completion. It performs the following steps when called:

1. If *obj* has a `[[Realm]]` internal slot, then
  - a. Return *obj*.`[[Realm]]`.
2. If *obj* is a bound function exotic object, then
  - a. Let *boundTargetFunction* be *obj*.`[[BoundTargetFunction]]`.
  - b. Return ? `GetFunctionRealm(boundTargetFunction)`.

3. If *obj* is a Proxy exotic object, then
  - a. Perform ? *ValidateNonRevokedProxy*(*obj*).
  - b. Let *proxyTarget* be *obj*.[[ProxyTarget]].
  - c. Return ? *GetFunctionRealm*(*proxyTarget*).
4. Return the current Realm Record.

NOTE Step 4 will only be reached if *obj* is a non-standard function exotic object that does not have a [[Realm]] internal slot.

### 7.3.26 CopyDataProperties ( *target*, *source*, *excludedItems* )

The abstract operation CopyDataProperties takes arguments *target* (an Object), *source* (an ECMAScript language value), and *excludedItems* (a List of property keys) and returns either a normal completion containing unused or a throw completion. It performs the following steps when called:

1. If *source* is either **undefined** or **null**, return unused.
2. Let *from* be ! *ToObject*(*source*).
3. Let *keys* be ? *from*.[[OwnPropertyKeys]]().
4. For each element *nextKey* of *keys*, do
  - a. Let *excluded* be **false**.
  - b. For each element *e* of *excludedItems*, do
    - i. If *SameValue*(*e*, *nextKey*) is **true**, then
      1. Set *excluded* to **true**.
  - c. If *excluded* is **false**, then
    - i. Let *desc* be ? *from*.[[GetOwnProperty]](*nextKey*).
    - ii. If *desc* is not **undefined** and *desc*.[[Enumerable]] is **true**, then
      1. Let *propValue* be ? *Get*(*from*, *nextKey*).
      2. Perform ! *CreateDataPropertyOrThrow*(*target*, *nextKey*, *propValue*).
5. Return unused.

NOTE The target passed in here is always a newly created object which is not directly accessible in case of an error being thrown.

### 7.3.27 PrivateElementFind ( *O*, *P* )

The abstract operation PrivateElementFind takes arguments *O* (an Object) and *P* (a Private Name) and returns a PrivateElement or empty. It performs the following steps when called:

1. If *O*.[[PrivateElements]] contains a PrivateElement *pe* such that *pe*.[[Key]] is *P*, then
  - a. Return *pe*.
2. Return empty.

### 7.3.28 PrivateFieldAdd ( *O*, *P*, *value* )

The abstract operation PrivateFieldAdd takes arguments *O* (an Object), *P* (a Private Name), and *value* (an ECMAScript language value) and returns either a normal completion containing unused or a throw completion. It performs the following steps when called:

1. If the *host* is a web browser, then

- a. Perform ? `HostEnsureCanAddPrivateElement(O)`.
2. Let `entry` be `PrivateElementFind(O, P)`.
3. If `entry` is not empty, throw a **TypeError** exception.
4. Append `PrivateElement` { `[[Key]]: P`, `[[Kind]]: field`, `[[Value]]: value` } to `O.[PrivateElements]`.
5. Return unused.

### 7.3.29 PrivateMethodOrAccessorAdd ( *O*, *method* )

The abstract operation `PrivateMethodOrAccessorAdd` takes arguments *O* (an Object) and *method* (a `PrivateElement`) and returns either a `normal completion containing` unused or a `throw completion`. It performs the following steps when called:

1. **Assert**: `method.[[Kind]]` is either method or accessor.
2. If the `host` is a web browser, then
  - a. Perform ? `HostEnsureCanAddPrivateElement(O)`.
3. Let `entry` be `PrivateElementFind(O, method.[[Key]])`.
4. If `entry` is not empty, throw a **TypeError** exception.
5. Append `method` to `O.[PrivateElements]`.
6. Return unused.

**NOTE** The values for private methods and accessors are shared across instances. This operation does not create a new copy of the method or accessor.

### 7.3.30 HostEnsureCanAddPrivateElement ( *O* )

The `host-defined` abstract operation `HostEnsureCanAddPrivateElement` takes argument *O* (an Object) and returns either a `normal completion containing` unused or a `throw completion`. It allows `host environments` to prevent the addition of private elements to particular `host-defined exotic objects`.

An implementation of `HostEnsureCanAddPrivateElement` must conform to the following requirements:

- If *O* is not a `host-defined exotic object`, this abstract operation must return `NormalCompletion(unused)` and perform no other steps.
- Any two calls of this abstract operation with the same argument must return the same kind of `Completion Record`.

The default implementation of `HostEnsureCanAddPrivateElement` is to return `NormalCompletion(unused)`.

This abstract operation is only invoked by ECMAScript `hosts` that are web browsers.

### 7.3.31 PrivateGet ( *O*, *P* )

The abstract operation `PrivateGet` takes arguments *O* (an Object) and *P* (a `Private Name`) and returns either a `normal completion containing` an ECMAScript language value or a `throw completion`. It performs the following steps when called:

1. Let `entry` be `PrivateElementFind(O, P)`.
2. If `entry` is empty, throw a **TypeError** exception.
3. If `entry.[[Kind]]` is either field or method, then
  - a. Return `entry.[[Value]]`.
4. **Assert**: `entry.[[Kind]]` is accessor.
5. If `entry.[[Get]]` is **undefined**, throw a **TypeError** exception.

6. Let *getter* be *entry*.[[Get]].
7. Return ? *Call*(*getter*, *O*).

### 7.3.32 PrivateSet ( *O*, *P*, *value* )

The abstract operation PrivateSet takes arguments *O* (an Object), *P* (a Private Name), and *value* (an ECMAScript language value) and returns either a normal completion containing unused or a throw completion. It performs the following steps when called:

1. Let *entry* be PrivateElementFind(*O*, *P*).
2. If *entry* is empty, throw a **TypeError** exception.
3. If *entry*.[[Kind]] is field, then
  - a. Set *entry*.[[Value]] to *value*.
4. Else if *entry*.[[Kind]] is method, then
  - a. Throw a **TypeError** exception.
5. Else,
  - a. Assert: *entry*.[[Kind]] is accessor.
  - b. If *entry*.[[Set]] is **undefined**, throw a **TypeError** exception.
  - c. Let *setter* be *entry*.[[Set]].
  - d. Perform ? *Call*(*setter*, *O*, « *value* »).
6. Return unused.

### 7.3.33 DefineField ( *receiver*, *fieldRecord* )

The abstract operation DefineField takes arguments *receiver* (an Object) and *fieldRecord* (a ClassFieldDefinition Record) and returns either a normal completion containing unused or a throw completion. It performs the following steps when called:

1. Let *fieldName* be *fieldRecord*.[[Name]].
2. Let *initializer* be *fieldRecord*.[[Initializer]].
3. If *initializer* is not empty, then
  - a. Let *initValue* be ? *Call*(*initializer*, *receiver*).
4. Else, let *initValue* be **undefined**.
5. If *fieldName* is a Private Name, then
  - a. Perform ? PrivateFieldAdd(*receiver*, *fieldName*, *initValue*).
6. Else,
  - a. Assert: IsPropertyKey(*fieldName*) is **true**.
  - b. Perform ? CreateDataPropertyOrThrow(*receiver*, *fieldName*, *initValue*).
7. Return unused.

### 7.3.34 InitializeInstanceElements ( *O*, *constructor* )

The abstract operation InitializeInstanceElements takes arguments *O* (an Object) and *constructor* (an ECMAScript function object) and returns either a normal completion containing unused or a throw completion. It performs the following steps when called:

1. Let *methods* be the value of *constructor*.[[PrivateMethods]].
2. For each PrivateElement *method* of *methods*, do
  - a. Perform ? PrivateMethodOrAccessorAdd(*O*, *method*).
3. Let *fields* be the value of *constructor*.[[Fields]].

4. For each element *fieldRecord* of *fields*, do
  - a. Perform ? *DefineField*(*O*, *fieldRecord*).
5. Return unused.

## 7.4 Operations on Iterator Objects

See Common Iteration Interfaces (27.1).

### 7.4.1 Iterator Records

An *Iterator Record* is a *Record* value used to encapsulate an *Iterator* or *AsyncIterator* along with the **next** method.

Iterator Records have the fields listed in Table 15.

Table 15: *Iterator Record* Fields

Field Name	Value	Meaning
[[Iterator]]	an Object	An object that conforms to the <i>Iterator</i> or <i>AsyncIterator</i> interface.
[[NextMethod]]	a <i>function object</i>	The <b>next</b> method of the [[Iterator]] object.
[[Done]]	a Boolean	Whether the iterator has been closed.

### 7.4.2 GetIteratorFromMethod ( *obj*, *method* )

The abstract operation *GetIteratorFromMethod* takes arguments *obj* (an *ECMAScript language value*) and *method* (a *function object*) and returns either a *normal completion* containing an *Iterator Record* or a *throw completion*. It performs the following steps when called:

1. Let *iterator* be ? *Call*(*method*, *obj*).
2. If *iterator* is not an *Object*, throw a **TypeError** exception.
3. Let *nextMethod* be ? *GetV*(*iterator*, "next").
4. Let *iteratorRecord* be the *Iterator Record* { [[Iterator]]: *iterator*, [[NextMethod]]: *nextMethod*, [[Done]]: **false** }.
5. Return *iteratorRecord*.

### 7.4.3 GetIterator ( *obj*, *kind* )

The abstract operation *GetIterator* takes arguments *obj* (an *ECMAScript language value*) and *kind* (sync or async) and returns either a *normal completion* containing an *Iterator Record* or a *throw completion*. It performs the following steps when called:

1. If *kind* is *async*, then
  - a. Let *method* be ? *GetMethod*(*obj*, @@*asyncIterator*).
  - b. If *method* is **undefined**, then
    - i. Let *syncMethod* be ? *GetMethod*(*obj*, @@*iterator*).
    - ii. If *syncMethod* is **undefined**, throw a **TypeError** exception.
    - iii. Let *syncIteratorRecord* be ? *GetIteratorFromMethod*(*obj*, *syncMethod*).
    - iv. Return *CreateAsyncFromSyncIterator*(*syncIteratorRecord*).



2. Otherwise, let *method* be ? `GetMethod(obj, @@iterator)`.
3. If *method* is **undefined**, throw a **TypeError** exception.
4. Return ? `GetIteratorFromMethod(obj, method)`.

#### 7.4.4 `IteratorNext ( iteratorRecord [ , value ] )`

The abstract operation `IteratorNext` takes argument *iteratorRecord* (an `Iterator Record`) and optional argument *value* (an ECMAScript language value) and returns either a `normal completion containing` an Object or a `throw completion`. It performs the following steps when called:

1. If *value* is not present, then
  - a. Let *result* be ? `Call(iteratorRecord.[[NextMethod]], iteratorRecord.[[Iterator]])`.
2. Else,
  - a. Let *result* be ? `Call(iteratorRecord.[[NextMethod]], iteratorRecord.[[Iterator]], « value »)`.
3. If *result* is not an Object, throw a **TypeError** exception.
4. Return *result*.

#### 7.4.5 `IteratorComplete ( iterResult )`

The abstract operation `IteratorComplete` takes argument *iterResult* (an Object) and returns either a `normal completion containing` a Boolean or a `throw completion`. It performs the following steps when called:

1. Return `ToBoolean(? Get(iterResult, "done"))`.

#### 7.4.6 `IteratorValue ( iterResult )`

The abstract operation `IteratorValue` takes argument *iterResult* (an Object) and returns either a `normal completion containing` an ECMAScript language value or a `throw completion`. It performs the following steps when called:

1. Return ? `Get(iterResult, "value")`.

#### 7.4.7 `IteratorStep ( iteratorRecord )`

The abstract operation `IteratorStep` takes argument *iteratorRecord* (an `Iterator Record`) and returns either a `normal completion containing` either an Object or **false**, or a `throw completion`. It requests the next value from *iteratorRecord*.`[[Iterator]]` by calling *iteratorRecord*.`[[NextMethod]]` and returns either **false** indicating that the iterator has reached its end or the `IteratorResult` object if a next value is available. It performs the following steps when called:

1. Let *result* be ? `IteratorNext(iteratorRecord)`.
2. Let *done* be ? `IteratorComplete(result)`.
3. If *done* is **true**, return **false**.
4. Return *result*.

#### 7.4.8 `IteratorClose ( iteratorRecord, completion )`

The abstract operation `IteratorClose` takes arguments *iteratorRecord* (an `Iterator Record`) and *completion* (a `Completion Record`) and returns a `Completion Record`. It is used to notify an iterator that it should perform any actions it would normally perform when it has reached its completed state. It performs the following steps when called:

1. Assert: *iteratorRecord*.[[Iterator]] is an Object.
2. Let *iterator* be *iteratorRecord*.[[Iterator]].
3. Let *innerResult* be *Completion*(*GetMethod*(*iterator*, "return")).
4. If *innerResult*.[[Type]] is normal, then
  - a. Let *return* be *innerResult*.[[Value]].
  - b. If *return* is **undefined**, return ? *completion*.
  - c. Set *innerResult* to *Completion*(*Call*(*return*, *iterator*)).
5. If *completion*.[[Type]] is throw, return ? *completion*.
6. If *innerResult*.[[Type]] is throw, return ? *innerResult*.
7. If *innerResult*.[[Value]] is not an Object, throw a **TypeError** exception.
8. Return ? *completion*.

#### 7.4.9 IfAbruptCloseIterator ( *value*, *iteratorRecord* )

IfAbruptCloseIterator is a shorthand for a sequence of algorithm steps that use an *Iterator Record*. An algorithm step of the form:

1. IfAbruptCloseIterator(*value*, *iteratorRecord*).

means the same thing as:

1. Assert: *value* is a *Completion Record*.
2. If *value* is an abrupt completion, return ? *IteratorClose*(*iteratorRecord*, *value*).
3. Else, set *value* to *value*.[[Value]].

#### 7.4.10 AsyncIteratorClose ( *iteratorRecord*, *completion* )

The abstract operation AsyncIteratorClose takes arguments *iteratorRecord* (an *Iterator Record*) and *completion* (a *Completion Record*) and returns a *Completion Record*. It is used to notify an async iterator that it should perform any actions it would normally perform when it has reached its completed state. It performs the following steps when called:

1. Assert: *iteratorRecord*.[[Iterator]] is an Object.
2. Let *iterator* be *iteratorRecord*.[[Iterator]].
3. Let *innerResult* be *Completion*(*GetMethod*(*iterator*, "return")).
4. If *innerResult*.[[Type]] is normal, then
  - a. Let *return* be *innerResult*.[[Value]].
  - b. If *return* is **undefined**, return ? *completion*.
  - c. Set *innerResult* to *Completion*(*Call*(*return*, *iterator*)).
  - d. If *innerResult*.[[Type]] is normal, set *innerResult* to *Completion*(*Await*(*innerResult*.[[Value]])).
5. If *completion*.[[Type]] is throw, return ? *completion*.
6. If *innerResult*.[[Type]] is throw, return ? *innerResult*.
7. If *innerResult*.[[Value]] is not an Object, throw a **TypeError** exception.
8. Return ? *completion*.

#### 7.4.11 CreateIterResultObject ( *value*, *done* )

The abstract operation CreateIterResultObject takes arguments *value* (an *ECMAScript language value*) and *done* (a Boolean) and returns an Object that conforms to the *IteratorResult* interface. It creates an object that conforms to the *IteratorResult* interface. It performs the following steps when called:

1. Let *obj* be `OrdinaryObjectCreate(%Object.prototype%)`.
2. Perform ! `CreateDataPropertyOrThrow(obj, "value", value)`.
3. Perform ! `CreateDataPropertyOrThrow(obj, "done", done)`.
4. Return *obj*.

#### 7.4.12 CreateListIteratorRecord ( *list* )

The abstract operation `CreateListIteratorRecord` takes argument *list* (a `List` of `ECMAScript language values`) and returns an `Iterator Record`. It creates an `Iterator` (27.1.1.2) object record whose `next` method returns the successive elements of *list*. It performs the following steps when called:

1. Let *closure* be a new `Abstract Closure` with no parameters that captures *list* and performs the following steps when called:
  - a. For each element *E* of *list*, do
    - i. Perform ? `GeneratorYield(CreateIterResultObject(E, false))`.
  - b. Return `NormalCompletion(undefined)`.
2. Let *iterator* be `CreateIteratorFromClosure(closure, empty, %IteratorPrototype%)`.
3. Return the `Iterator Record` { `[[Iterator]]: iterator`, `[[NextMethod]]: %GeneratorFunction.prototype.prototype.next%`, `[[Done]]: false` }.

**NOTE** The list iterator object is never directly accessible to ECMAScript code.

#### 7.4.13 IteratorToList ( *iteratorRecord* )

The abstract operation `IteratorToList` takes argument *iteratorRecord* (an `Iterator Record`) and returns either a `normal completion containing` a `List` of `ECMAScript language values` or a `throw completion`. It performs the following steps when called:

1. Let *values* be a new empty `List`.
2. Let *next* be `true`.
3. Repeat, while *next* is not `false`,
  - a. Set *next* to ? `IteratorStep(iteratorRecord)`.
  - b. If *next* is not `false`, then
    - i. Let *nextValue* be ? `IteratorValue(next)`.
    - ii. Append *nextValue* to *values*.
4. Return *values*.

## 8 Syntax-Directed Operations

In addition to those defined in this section, specialized `syntax-directed operations` are defined throughout this specification.

### 8.1 Runtime Semantics: Evaluation

The `syntax-directed operation` `Evaluation` takes no arguments and returns a `Completion Record`.

**NOTE** The definitions for this operation are distributed over the "ECMAScript Language" sections of this specification. Each definition appears after the defining occurrence of the relevant productions.

## 8.2 Scope Analysis

### 8.2.1 Static Semantics: BoundNames

The [syntax-directed operation](#) BoundNames takes no arguments and returns a [List](#) of Strings.

**NOTE** **"\*default\*"** is used within this specification as a synthetic name for a module's default export when it does not have another name. An entry in the module's [\[\[Environment\]\]](#) is created with that name and holds the corresponding value, and resolving the export named **"default"** by calling [ResolveExport](#) ( *exportName* [ , *resolveSet* ] ) for the module will return a [ResolvedBinding Record](#) whose [\[\[BindingName\]\]](#) is **"\*default\*"**, which will then resolve in the module's [\[\[Environment\]\]](#) to the above-mentioned value. This is done only for ease of specification, so that anonymous default exports can be resolved like any other export. This **"\*default\*"** string is never accessible to ECMAScript code or to the module linking algorithm.

It is defined piecewise over the following productions:

*BindingIdentifier* : *Identifier*

1. Return a [List](#) whose sole element is the [StringValue](#) of *Identifier*.

*BindingIdentifier* : **yield**

1. Return « **"yield"** ».

*BindingIdentifier* : **await**

1. Return « **"await"** ».

*LexicalDeclaration* : *LetOrConst BindingList* ;

1. Return the [BoundNames](#) of *BindingList*.

*BindingList* : *BindingList* , *LexicalBinding*

1. Let *names1* be the [BoundNames](#) of *BindingList*.
2. Let *names2* be the [BoundNames](#) of *LexicalBinding*.
3. Return the [list-concatenation](#) of *names1* and *names2*.

*LexicalBinding* : *BindingIdentifier Initializer*<sub>opt</sub>

1. Return the [BoundNames](#) of *BindingIdentifier*.

*LexicalBinding* : *BindingPattern Initializer*

1. Return the [BoundNames](#) of *BindingPattern*.

*VariableDeclarationList* : *VariableDeclarationList* , *VariableDeclaration*

1. Let *names1* be **BoundNames** of *VariableDeclarationList*.
2. Let *names2* be **BoundNames** of *VariableDeclaration*.
3. Return the **list-concatenation** of *names1* and *names2*.

*VariableDeclaration* : *BindingIdentifier* *Initializer*<sub>opt</sub>

1. Return the **BoundNames** of *BindingIdentifier*.

*VariableDeclaration* : *BindingPattern* *Initializer*

1. Return the **BoundNames** of *BindingPattern*.

*ObjectBindingPattern* : { }

1. Return a new empty **List**.

*ObjectBindingPattern* : { *BindingPropertyList* , *BindingRestProperty* }

1. Let *names1* be **BoundNames** of *BindingPropertyList*.
2. Let *names2* be **BoundNames** of *BindingRestProperty*.
3. Return the **list-concatenation** of *names1* and *names2*.

*ArrayBindingPattern* : [ *Elision*<sub>opt</sub> ]

1. Return a new empty **List**.

*ArrayBindingPattern* : [ *Elision*<sub>opt</sub> *BindingRestElement* ]

1. Return the **BoundNames** of *BindingRestElement*.

*ArrayBindingPattern* : [ *BindingElementList* , *Elision*<sub>opt</sub> ]

1. Return the **BoundNames** of *BindingElementList*.

*ArrayBindingPattern* : [ *BindingElementList* , *Elision*<sub>opt</sub> *BindingRestElement* ]

1. Let *names1* be **BoundNames** of *BindingElementList*.
2. Let *names2* be **BoundNames** of *BindingRestElement*.
3. Return the **list-concatenation** of *names1* and *names2*.

*BindingPropertyList* : *BindingPropertyList* , *BindingProperty*

1. Let *names1* be **BoundNames** of *BindingPropertyList*.
2. Let *names2* be **BoundNames** of *BindingProperty*.
3. Return the **list-concatenation** of *names1* and *names2*.

*BindingElementList* : *BindingElementList* , *BindingElisionElement*

1. Let *names1* be **BoundNames** of *BindingElementList*.
2. Let *names2* be **BoundNames** of *BindingElisionElement*.
3. Return the **list-concatenation** of *names1* and *names2*.

*BindingElisionElement* : *Elision*<sub>opt</sub> *BindingElement*

1. Return **BoundNames** of *BindingElement*.

*BindingProperty* : *PropertyName* : *BindingElement*

1. Return the [BoundNames](#) of *BindingElement*.

*SingleNameBinding* : *BindingIdentifier* *Initializer*<sub>opt</sub>

1. Return the [BoundNames](#) of *BindingIdentifier*.

*BindingElement* : *BindingPattern* *Initializer*<sub>opt</sub>

1. Return the [BoundNames](#) of *BindingPattern*.

*ForDeclaration* : *LetOrConst* *ForBinding*

1. Return the [BoundNames](#) of *ForBinding*.

*FunctionDeclaration* : **function** *BindingIdentifier* ( *FormalParameters* ) { *FunctionBody* }

1. Return the [BoundNames](#) of *BindingIdentifier*.

*FunctionDeclaration* : **function** ( *FormalParameters* ) { *FunctionBody* }

1. Return « **\*\*default\*\*** ».

*FormalParameters* : [empty]

1. Return a new empty [List](#).

*FormalParameters* : *FormalParameterList* , *FunctionRestParameter*

1. Let *names1* be [BoundNames](#) of *FormalParameterList*.
2. Let *names2* be [BoundNames](#) of *FunctionRestParameter*.
3. Return the [list-concatenation](#) of *names1* and *names2*.

*FormalParameterList* : *FormalParameterList* , *FormalParameter*

1. Let *names1* be [BoundNames](#) of *FormalParameterList*.
2. Let *names2* be [BoundNames](#) of *FormalParameter*.
3. Return the [list-concatenation](#) of *names1* and *names2*.

*ArrowParameters* : *CoverParenthesizedExpressionAndArrowParameterList*

1. Let *formals* be the *ArrowFormalParameters* that is [covered](#) by *CoverParenthesizedExpressionAndArrowParameterList*.
2. Return the [BoundNames](#) of *formals*.

*GeneratorDeclaration* : **function** \* *BindingIdentifier* ( *FormalParameters* ) { *GeneratorBody* }

1. Return the [BoundNames](#) of *BindingIdentifier*.

*GeneratorDeclaration* : **function** \* ( *FormalParameters* ) { *GeneratorBody* }

1. Return « **\*\*default\*\*** ».

*AsyncGeneratorDeclaration* : **async function** \* *BindingIdentifier* ( *FormalParameters* ) { *AsyncGeneratorBody* }

1. Return the [BoundNames](#) of *BindingIdentifier*.

*AsyncGeneratorDeclaration* : **async function** \* ( *FormalParameters* ) { *AsyncGeneratorBody* }

1. Return « **\*\*default\*\*** ».

*ClassDeclaration* : **class** *BindingIdentifier* *ClassTail*

1. Return the [BoundNames](#) of *BindingIdentifier*.

*ClassDeclaration* : **class** *ClassTail*

1. Return « **\*\*default\*\*** ».

*AsyncFunctionDeclaration* : **async function** *BindingIdentifier* ( *FormalParameters* ) { *AsyncFunctionBody* }

1. Return the [BoundNames](#) of *BindingIdentifier*.

*AsyncFunctionDeclaration* : **async function** ( *FormalParameters* ) { *AsyncFunctionBody* }

1. Return « **\*\*default\*\*** ».

*CoverCallExpressionAndAsyncArrowHead* : *MemberExpression* *Arguments*

1. Let *head* be the *AsyncArrowHead* that is [covered](#) by *CoverCallExpressionAndAsyncArrowHead*.
2. Return the [BoundNames](#) of *head*.

*ImportDeclaration* : **import** *ImportClause* *FromClause* ;

1. Return the [BoundNames](#) of *ImportClause*.

*ImportDeclaration* : **import** *ModuleSpecifier* ;

1. Return a new empty [List](#).

*ImportClause* : *ImportedDefaultBinding* , *NameSpaceImport*

1. Let *names1* be the [BoundNames](#) of *ImportedDefaultBinding*.
2. Let *names2* be the [BoundNames](#) of *NameSpaceImport*.
3. Return the [list-concatenation](#) of *names1* and *names2*.

*ImportClause* : *ImportedDefaultBinding* , *NamedImports*

1. Let *names1* be the [BoundNames](#) of *ImportedDefaultBinding*.
2. Let *names2* be the [BoundNames](#) of *NamedImports*.
3. Return the [list-concatenation](#) of *names1* and *names2*.

*NamedImports* : { }

1. Return a new empty [List](#).

*ImportsList* : *ImportsList* , *ImportSpecifier*

1. Let *names1* be the [BoundNames](#) of *ImportsList*.
2. Let *names2* be the [BoundNames](#) of *ImportSpecifier*.
3. Return the [list-concatenation](#) of *names1* and *names2*.

*ImportSpecifier* : *ModuleExportName* **as** *ImportedBinding*

1. Return the [BoundNames](#) of *ImportedBinding*.

*ExportDeclaration* :

**export** *ExportFromClause* *FromClause* ;  
**export** *NamedExports* ;

1. Return a new empty [List](#).

*ExportDeclaration* : **export** *VariableStatement*

1. Return the [BoundNames](#) of *VariableStatement*.

*ExportDeclaration* : **export** *Declaration*

1. Return the [BoundNames](#) of *Declaration*.

*ExportDeclaration* : **export default** *HoistableDeclaration*

1. Let *declarationNames* be the [BoundNames](#) of *HoistableDeclaration*.
2. If *declarationNames* does not include the element **"\*default\*"**, append **"\*default\*"** to *declarationNames*.
3. Return *declarationNames*.

*ExportDeclaration* : **export default** *ClassDeclaration*

1. Let *declarationNames* be the [BoundNames](#) of *ClassDeclaration*.
2. If *declarationNames* does not include the element **"\*default\*"**, append **"\*default\*"** to *declarationNames*.
3. Return *declarationNames*.

*ExportDeclaration* : **export default** *AssignmentExpression* ;

1. Return « **"\*default\*"** ».

## 8.2.2 Static Semantics: DeclarationPart

The [syntax-directed operation](#) DeclarationPart takes no arguments and returns a [Parse Node](#). It is defined piecewise over the following productions:

*HoistableDeclaration* : *FunctionDeclaration*

1. Return *FunctionDeclaration*.

*HoistableDeclaration* : *GeneratorDeclaration*

1. Return *GeneratorDeclaration*.

*HoistableDeclaration* : *AsyncFunctionDeclaration*

1. Return *AsyncFunctionDeclaration*.

*HoistableDeclaration* : *AsyncGeneratorDeclaration*

1. Return *AsyncGeneratorDeclaration*.

*Declaration* : *ClassDeclaration*

1. Return *ClassDeclaration*.

*Declaration* : *LexicalDeclaration*

1. Return *LexicalDeclaration*.

## 8.2.3 Static Semantics: IsConstantDeclaration

The [syntax-directed operation](#) IsConstantDeclaration takes no arguments and returns a Boolean. It is defined piecewise over the following productions:



*LexicalDeclaration* : *LetOrConst BindingList* ;

1. Return [IsConstantDeclaration](#) of *LetOrConst*.

*LetOrConst* : **let**

1. Return **false**.

*LetOrConst* : **const**

1. Return **true**.

*FunctionDeclaration* :

**function** *BindingIdentifier* ( *FormalParameters* ) { *FunctionBody* }

**function** ( *FormalParameters* ) { *FunctionBody* }

*GeneratorDeclaration* :

**function** \* *BindingIdentifier* ( *FormalParameters* ) { *GeneratorBody* }

**function** \* ( *FormalParameters* ) { *GeneratorBody* }

*AsyncGeneratorDeclaration* :

**async function** \* *BindingIdentifier* ( *FormalParameters* ) { *AsyncGeneratorBody* }

**async function** \* ( *FormalParameters* ) { *AsyncGeneratorBody* }

*AsyncFunctionDeclaration* :

**async function** *BindingIdentifier* ( *FormalParameters* ) { *AsyncFunctionBody* }

**async function** ( *FormalParameters* ) { *AsyncFunctionBody* }

1. Return **false**.

*ClassDeclaration* :

**class** *BindingIdentifier* *ClassTail*

**class** *ClassTail*

1. Return **false**.

*ExportDeclaration* :

**export** *ExportFromClause* *FromClause* ;

**export** *NamedExports* ;

**export default** *AssignmentExpression* ;

1. Return **false**.

**NOTE** It is not necessary to treat **export default** *AssignmentExpression* as a constant declaration because there is no syntax that permits assignment to the internal bound name used to reference a module's default object.

## 8.2.4 Static Semantics: *LexicallyDeclaredNames*

The [syntax-directed operation](#) *LexicallyDeclaredNames* takes no arguments and returns a [List](#) of Strings. It is defined piecewise over the following productions:

*Block* : { }

1. Return a new empty [List](#).

*StatementList* : *StatementList* *StatementListItem*

1. Let *names1* be [LexicallyDeclaredNames](#) of *StatementList*.
2. Let *names2* be [LexicallyDeclaredNames](#) of *StatementListItem*.
3. Return the [list-concatenation](#) of *names1* and *names2*.

*StatementListItem* : *Statement*

1. If *Statement* is *Statement* : *LabelledStatement* , return [LexicallyDeclaredNames](#) of *LabelledStatement*.
2. Return a new empty [List](#).

*StatementListItem* : *Declaration*

1. Return the [BoundNames](#) of *Declaration*.

*CaseBlock* : { }

1. Return a new empty [List](#).

*CaseBlock* : { *CaseClauses*<sub>opt</sub> *DefaultClause* *CaseClauses*<sub>opt</sub> }

1. If the first *CaseClauses* is present, let *names1* be the [LexicallyDeclaredNames](#) of the first *CaseClauses*.
2. Else, let *names1* be a new empty [List](#).
3. Let *names2* be [LexicallyDeclaredNames](#) of *DefaultClause*.
4. If the second *CaseClauses* is present, let *names3* be the [LexicallyDeclaredNames](#) of the second *CaseClauses*.
5. Else, let *names3* be a new empty [List](#).
6. Return the [list-concatenation](#) of *names1*, *names2*, and *names3*.

*CaseClauses* : *CaseClauses* *CaseClause*

1. Let *names1* be [LexicallyDeclaredNames](#) of *CaseClauses*.
2. Let *names2* be [LexicallyDeclaredNames](#) of *CaseClause*.
3. Return the [list-concatenation](#) of *names1* and *names2*.

*CaseClause* : **case** *Expression* : *StatementList*<sub>opt</sub>

1. If the *StatementList* is present, return the [LexicallyDeclaredNames](#) of *StatementList*.
2. Return a new empty [List](#).

*DefaultClause* : **default** : *StatementList*<sub>opt</sub>

1. If the *StatementList* is present, return the [LexicallyDeclaredNames](#) of *StatementList*.
2. Return a new empty [List](#).

*LabelledStatement* : *LabelIdentifier* : *LabelledItem*

1. Return the [LexicallyDeclaredNames](#) of *LabelledItem*.

*LabelledItem* : *Statement*

1. Return a new empty [List](#).

*LabelledItem* : *FunctionDeclaration*

1. Return [BoundNames](#) of *FunctionDeclaration*.

*FunctionStatementList* : [empty]

1. Return a new empty [List](#).

*FunctionStatementList* : *StatementList*

1. Return [TopLevelLexicallyDeclaredNames](#) of *StatementList*.

*ClassStaticBlockStatementList* : [empty]

1. Return a new empty [List](#).

*ClassStaticBlockStatementList* : *StatementList*

1. Return the [TopLevelLexicallyDeclaredNames](#) of *StatementList*.

*ConciseBody* : *ExpressionBody*

1. Return a new empty [List](#).

*AsyncConciseBody* : *ExpressionBody*

1. Return a new empty [List](#).

*Script* : [empty]

1. Return a new empty [List](#).

*ScriptBody* : *StatementList*

1. Return [TopLevelLexicallyDeclaredNames](#) of *StatementList*.

NOTE 1 At the top level of a *Script*, function declarations are treated like var declarations rather than like lexical declarations.

NOTE 2 The [LexicallyDeclaredNames](#) of a *Module* includes the names of all of its imported bindings.

*ModuleItemList* : *ModuleItemList* *ModuleItem*

1. Let *names1* be [LexicallyDeclaredNames](#) of *ModuleItemList*.
2. Let *names2* be [LexicallyDeclaredNames](#) of *ModuleItem*.
3. Return the [list-concatenation](#) of *names1* and *names2*.

*ModuleItem* : *ImportDeclaration*

1. Return the [BoundNames](#) of *ImportDeclaration*.

*ModuleItem* : *ExportDeclaration*

1. If *ExportDeclaration* is **export** *VariableStatement*, return a new empty [List](#).
2. Return the [BoundNames](#) of *ExportDeclaration*.

*ModuleItem* : *StatementListItem*

1. Return [LexicallyDeclaredNames](#) of *StatementListItem*.

NOTE 3 At the top level of a *Module*, function declarations are treated like lexical declarations rather than like var declarations.

## 8.2.5 Static Semantics: LexicallyScopedDeclarations

The [syntax-directed operation](#) `LexicallyScopedDeclarations` takes no arguments and returns a [List of Parse Nodes](#). It is defined piecewise over the following productions:

*StatementList* : *StatementList StatementListItem*

1. Let *declarations1* be [LexicallyScopedDeclarations](#) of *StatementList*.
2. Let *declarations2* be [LexicallyScopedDeclarations](#) of *StatementListItem*.
3. Return the [list-concatenation](#) of *declarations1* and *declarations2*.

*StatementListItem* : *Statement*

1. If *Statement* is *Statement* : *LabelledStatement* , return [LexicallyScopedDeclarations](#) of *LabelledStatement*.
2. Return a new empty [List](#).

*StatementListItem* : *Declaration*

1. Return a [List](#) whose sole element is [DeclarationPart](#) of *Declaration*.

*CaseBlock* : { }

1. Return a new empty [List](#).

*CaseBlock* : { *CaseClauses*<sub>opt</sub> *DefaultClause* *CaseClauses*<sub>opt</sub> }

1. If the first *CaseClauses* is present, let *declarations1* be the [LexicallyScopedDeclarations](#) of the first *CaseClauses*.
2. Else, let *declarations1* be a new empty [List](#).
3. Let *declarations2* be [LexicallyScopedDeclarations](#) of *DefaultClause*.
4. If the second *CaseClauses* is present, let *declarations3* be the [LexicallyScopedDeclarations](#) of the second *CaseClauses*.
5. Else, let *declarations3* be a new empty [List](#).
6. Return the [list-concatenation](#) of *declarations1*, *declarations2*, and *declarations3*.

*CaseClauses* : *CaseClauses CaseClause*

1. Let *declarations1* be [LexicallyScopedDeclarations](#) of *CaseClauses*.
2. Let *declarations2* be [LexicallyScopedDeclarations](#) of *CaseClause*.
3. Return the [list-concatenation](#) of *declarations1* and *declarations2*.

*CaseClause* : **case** *Expression* : *StatementList*<sub>opt</sub>

1. If the *StatementList* is present, return the [LexicallyScopedDeclarations](#) of *StatementList*.
2. Return a new empty [List](#).

*DefaultClause* : **default** : *StatementList*<sub>opt</sub>

1. If the *StatementList* is present, return the [LexicallyScopedDeclarations](#) of *StatementList*.
2. Return a new empty [List](#).

*LabelledStatement* : *LabelIdentifier* : *LabelledItem*

1. Return the [LexicallyScopedDeclarations](#) of *LabelledItem*.

*LabelledItem* : *Statement*

1. Return a new empty [List](#).

*LabelledItem* : *FunctionDeclaration*

1. Return « *FunctionDeclaration* ».

*FunctionStatementList* : [empty]

1. Return a new empty [List](#).

*FunctionStatementList* : *StatementList*

1. Return the [TopLevelLexicallyScopedDeclarations](#) of *StatementList*.

*ClassStaticBlockStatementList* : [empty]

1. Return a new empty [List](#).

*ClassStaticBlockStatementList* : *StatementList*

1. Return the [TopLevelLexicallyScopedDeclarations](#) of *StatementList*.

*ConciseBody* : *ExpressionBody*

1. Return a new empty [List](#).

*AsyncConciseBody* : *ExpressionBody*

1. Return a new empty [List](#).

*Script* : [empty]

1. Return a new empty [List](#).

*ScriptBody* : *StatementList*

1. Return [TopLevelLexicallyScopedDeclarations](#) of *StatementList*.

*Module* : [empty]

1. Return a new empty [List](#).

*ModuleItemList* : *ModuleItem* *ModuleItem*

1. Let *declarations1* be [LexicallyScopedDeclarations](#) of *ModuleItemList*.
2. Let *declarations2* be [LexicallyScopedDeclarations](#) of *ModuleItem*.
3. Return the [list-concatenation](#) of *declarations1* and *declarations2*.

*ModuleItem* : *ImportDeclaration*

1. Return a new empty [List](#).

*ExportDeclaration* :

```
export ExportFromClause FromClause ;  
export NamedExports ;  
export VariableStatement
```

1. Return a new empty [List](#).

*ExportDeclaration* : **export** *Declaration*

1. Return a [List](#) whose sole element is [DeclarationPart](#) of *Declaration*.

*ExportDeclaration* : **export default** *HoistableDeclaration*

1. Return a [List](#) whose sole element is [DeclarationPart](#) of *HoistableDeclaration*.

*ExportDeclaration* : **export default** *ClassDeclaration*

1. Return a [List](#) whose sole element is *ClassDeclaration*.

*ExportDeclaration* : **export default** *AssignmentExpression* ;

1. Return a [List](#) whose sole element is this *ExportDeclaration*.

## 8.2.6 Static Semantics: [VarDeclaredNames](#)

The [syntax-directed operation](#) [VarDeclaredNames](#) takes no arguments and returns a [List](#) of Strings. It is defined piecewise over the following productions:

*Statement* :

*EmptyStatement*  
*ExpressionStatement*  
*ContinueStatement*  
*BreakStatement*  
*ReturnStatement*  
*ThrowStatement*  
*DebuggerStatement*

1. Return a new empty [List](#).

*Block* : { }

1. Return a new empty [List](#).

*StatementList* : *StatementList* *StatementListItem*

1. Let *names1* be [VarDeclaredNames](#) of *StatementList*.
2. Let *names2* be [VarDeclaredNames](#) of *StatementListItem*.
3. Return the [list-concatenation](#) of *names1* and *names2*.

*StatementListItem* : *Declaration*

1. Return a new empty [List](#).

*VariableStatement* : **var** *VariableDeclarationList* ;

1. Return [BoundNames](#) of *VariableDeclarationList*.

*IfStatement* : **if** ( *Expression* ) *Statement* **else** *Statement*

1. Let *names1* be [VarDeclaredNames](#) of the first *Statement*.
2. Let *names2* be [VarDeclaredNames](#) of the second *Statement*.
3. Return the [list-concatenation](#) of *names1* and *names2*.

*IfStatement* : **if** ( *Expression* ) *Statement*

1. Return the [VarDeclaredNames](#) of *Statement*.

*DoWhileStatement* : **do** *Statement* **while** ( *Expression* ) ;

1. Return the [VarDeclaredNames](#) of *Statement*.

*WhileStatement* : **while** ( *Expression* ) *Statement*

1. Return the [VarDeclaredNames](#) of *Statement*.

*ForStatement* : **for** ( *Expression*<sub>opt</sub> ; *Expression*<sub>opt</sub> ; *Expression*<sub>opt</sub> ) *Statement*

1. Return the [VarDeclaredNames](#) of *Statement*.

*ForStatement* : **for** ( **var** *VariableDeclarationList* ; *Expression*<sub>opt</sub> ; *Expression*<sub>opt</sub> ) *Statement*

1. Let *names1* be [BoundNames](#) of *VariableDeclarationList*.
2. Let *names2* be [VarDeclaredNames](#) of *Statement*.
3. Return the [list-concatenation](#) of *names1* and *names2*.

*ForStatement* : **for** ( *LexicalDeclaration* *Expression*<sub>opt</sub> ; *Expression*<sub>opt</sub> ) *Statement*

1. Return the [VarDeclaredNames](#) of *Statement*.

*ForInOfStatement* :

```

for ( LeftHandSideExpression in Expression ) Statement
for ( ForDeclaration in Expression ) Statement
for ( LeftHandSideExpression of AssignmentExpression ) Statement
for ( ForDeclaration of AssignmentExpression ) Statement
for await ( LeftHandSideExpression of AssignmentExpression ) Statement
for await ( ForDeclaration of AssignmentExpression ) Statement

```

1. Return the [VarDeclaredNames](#) of *Statement*.

*ForInOfStatement* :

```

for ( var ForBinding in Expression ) Statement
for ( var ForBinding of AssignmentExpression ) Statement
for await ( var ForBinding of AssignmentExpression ) Statement

```

1. Let *names1* be the [BoundNames](#) of *ForBinding*.
2. Let *names2* be the [VarDeclaredNames](#) of *Statement*.
3. Return the [list-concatenation](#) of *names1* and *names2*.

**NOTE** This section is extended by Annex [B.3.5](#).

*WithStatement* : **with** ( *Expression* ) *Statement*

1. Return the [VarDeclaredNames](#) of *Statement*.

*SwitchStatement* : **switch** ( *Expression* ) *CaseBlock*

1. Return the [VarDeclaredNames](#) of *CaseBlock*.

*CaseBlock* : { }

1. Return a new empty [List](#).

*CaseBlock* : { *CaseClauses*<sub>opt</sub> *DefaultClause* *CaseClauses*<sub>opt</sub> }

1. If the first *CaseClauses* is present, let *names1* be the [VarDeclaredNames](#) of the first *CaseClauses*.
2. Else, let *names1* be a new empty [List](#).

3. Let *names2* be *VarDeclaredNames* of *DefaultClause*.
4. If the second *CaseClauses* is present, let *names3* be the *VarDeclaredNames* of the second *CaseClauses*.
5. Else, let *names3* be a new empty *List*.
6. Return the *list-concatenation* of *names1*, *names2*, and *names3*.

*CaseClauses* : *CaseClauses* *CaseClause*

1. Let *names1* be *VarDeclaredNames* of *CaseClauses*.
2. Let *names2* be *VarDeclaredNames* of *CaseClause*.
3. Return the *list-concatenation* of *names1* and *names2*.

*CaseClause* : **case** *Expression* : *StatementList*<sub>opt</sub>

1. If the *StatementList* is present, return the *VarDeclaredNames* of *StatementList*.
2. Return a new empty *List*.

*DefaultClause* : **default** : *StatementList*<sub>opt</sub>

1. If the *StatementList* is present, return the *VarDeclaredNames* of *StatementList*.
2. Return a new empty *List*.

*LabelledStatement* : *LabelIdentifier* : *LabelledItem*

1. Return the *VarDeclaredNames* of *LabelledItem*.

*LabelledItem* : *FunctionDeclaration*

1. Return a new empty *List*.

*TryStatement* : **try** *Block* *Catch*

1. Let *names1* be *VarDeclaredNames* of *Block*.
2. Let *names2* be *VarDeclaredNames* of *Catch*.
3. Return the *list-concatenation* of *names1* and *names2*.

*TryStatement* : **try** *Block* *Finally*

1. Let *names1* be *VarDeclaredNames* of *Block*.
2. Let *names2* be *VarDeclaredNames* of *Finally*.
3. Return the *list-concatenation* of *names1* and *names2*.

*TryStatement* : **try** *Block* *Catch* *Finally*

1. Let *names1* be *VarDeclaredNames* of *Block*.
2. Let *names2* be *VarDeclaredNames* of *Catch*.
3. Let *names3* be *VarDeclaredNames* of *Finally*.
4. Return the *list-concatenation* of *names1*, *names2*, and *names3*.

*Catch* : **catch** ( *CatchParameter* ) *Block*

1. Return the *VarDeclaredNames* of *Block*.

*FunctionStatementList* : [empty]

1. Return a new empty *List*.

*FunctionStatementList* : *StatementList*



1. Return [TopLevelVarDeclaredNames](#) of *StatementList*.

*ClassStaticBlockStatementList* : [empty]

1. Return a new empty [List](#).

*ClassStaticBlockStatementList* : *StatementList*

1. Return the [TopLevelVarDeclaredNames](#) of *StatementList*.

*ConciseBody* : *ExpressionBody*

1. Return a new empty [List](#).

*AsyncConciseBody* : *ExpressionBody*

1. Return a new empty [List](#).

*Script* : [empty]

1. Return a new empty [List](#).

*ScriptBody* : *StatementList*

1. Return [TopLevelVarDeclaredNames](#) of *StatementList*.

*ModuleItemList* : *ModuleItemList* *ModuleItem*

1. Let *names1* be [VarDeclaredNames](#) of *ModuleItemList*.
2. Let *names2* be [VarDeclaredNames](#) of *ModuleItem*.
3. Return the [list-concatenation](#) of *names1* and *names2*.

*ModuleItem* : *ImportDeclaration*

1. Return a new empty [List](#).

*ModuleItem* : *ExportDeclaration*

1. If *ExportDeclaration* is **export** *VariableStatement*, return [BoundNames](#) of *ExportDeclaration*.
2. Return a new empty [List](#).

## 8.2.7 Static Semantics: VarScopedDeclarations

The [syntax-directed operation](#) *VarScopedDeclarations* takes no arguments and returns a [List](#) of [Parse Nodes](#). It is defined piecewise over the following productions:

*Statement* :

*EmptyStatement*  
*ExpressionStatement*  
*ContinueStatement*  
*BreakStatement*  
*ReturnStatement*  
*ThrowStatement*  
*DebuggerStatement*

1. Return a new empty [List](#).

*Block* : { }

1. Return a new empty [List](#).

*StatementList* : *StatementList* *StatementListItem*

1. Let *declarations1* be [VarScopedDeclarations](#) of *StatementList*.
2. Let *declarations2* be [VarScopedDeclarations](#) of *StatementListItem*.
3. Return the [list-concatenation](#) of *declarations1* and *declarations2*.

*StatementListItem* : *Declaration*

1. Return a new empty [List](#).

*VariableDeclarationList* : *VariableDeclaration*

1. Return « *VariableDeclaration* ».

*VariableDeclarationList* : *VariableDeclarationList* , *VariableDeclaration*

1. Let *declarations1* be [VarScopedDeclarations](#) of *VariableDeclarationList*.
2. Return the [list-concatenation](#) of *declarations1* and « *VariableDeclaration* ».

*IfStatement* : **if** ( *Expression* ) *Statement* **else** *Statement*

1. Let *declarations1* be [VarScopedDeclarations](#) of the first *Statement*.
2. Let *declarations2* be [VarScopedDeclarations](#) of the second *Statement*.
3. Return the [list-concatenation](#) of *declarations1* and *declarations2*.

*IfStatement* : **if** ( *Expression* ) *Statement*

1. Return the [VarScopedDeclarations](#) of *Statement*.

*DoWhileStatement* : **do** *Statement* **while** ( *Expression* ) ;

1. Return the [VarScopedDeclarations](#) of *Statement*.

*WhileStatement* : **while** ( *Expression* ) *Statement*

1. Return the [VarScopedDeclarations](#) of *Statement*.

*ForStatement* : **for** ( *Expression*<sub>opt</sub> ; *Expression*<sub>opt</sub> ; *Expression*<sub>opt</sub> ) *Statement*

1. Return the [VarScopedDeclarations](#) of *Statement*.

*ForStatement* : **for** ( **var** *VariableDeclarationList* ; *Expression*<sub>opt</sub> ; *Expression*<sub>opt</sub> ) *Statement*

1. Let *declarations1* be [VarScopedDeclarations](#) of *VariableDeclarationList*.
2. Let *declarations2* be [VarScopedDeclarations](#) of *Statement*.
3. Return the [list-concatenation](#) of *declarations1* and *declarations2*.

*ForStatement* : **for** ( *LexicalDeclaration* *Expression*<sub>opt</sub> ; *Expression*<sub>opt</sub> ) *Statement*

1. Return the [VarScopedDeclarations](#) of *Statement*.

*ForInOfStatement* :

- for** ( *LeftHandSideExpression* **in** *Expression* ) *Statement*
- for** ( *ForDeclaration* **in** *Expression* ) *Statement*
- for** ( *LeftHandSideExpression* **of** *AssignmentExpression* ) *Statement*
- for** ( *ForDeclaration* **of** *AssignmentExpression* ) *Statement*
- for await** ( *LeftHandSideExpression* **of** *AssignmentExpression* ) *Statement*

**for await** ( *ForDeclaration* of *AssignmentExpression* ) *Statement*

1. Return the [VarScopedDeclarations](#) of *Statement*.

*ForInOfStatement* :

**for** ( **var** *ForBinding* **in** *Expression* ) *Statement*  
**for** ( **var** *ForBinding* **of** *AssignmentExpression* ) *Statement*  
**for await** ( **var** *ForBinding* **of** *AssignmentExpression* ) *Statement*

1. Let *declarations1* be « *ForBinding* ».
2. Let *declarations2* be [VarScopedDeclarations](#) of *Statement*.
3. Return the [list-concatenation](#) of *declarations1* and *declarations2*.

**NOTE** This section is extended by Annex B.3.5.

*WithStatement* : **with** ( *Expression* ) *Statement*

1. Return the [VarScopedDeclarations](#) of *Statement*.

*SwitchStatement* : **switch** ( *Expression* ) *CaseBlock*

1. Return the [VarScopedDeclarations](#) of *CaseBlock*.

*CaseBlock* : { }

1. Return a new empty [List](#).

*CaseBlock* : { *CaseClauses*<sub>opt</sub> *DefaultClause* *CaseClauses*<sub>opt</sub> }

1. If the first *CaseClauses* is present, let *declarations1* be the [VarScopedDeclarations](#) of the first *CaseClauses*.
2. Else, let *declarations1* be a new empty [List](#).
3. Let *declarations2* be [VarScopedDeclarations](#) of *DefaultClause*.
4. If the second *CaseClauses* is present, let *declarations3* be the [VarScopedDeclarations](#) of the second *CaseClauses*.
5. Else, let *declarations3* be a new empty [List](#).
6. Return the [list-concatenation](#) of *declarations1*, *declarations2*, and *declarations3*.

*CaseClauses* : *CaseClauses* *CaseClause*

1. Let *declarations1* be [VarScopedDeclarations](#) of *CaseClauses*.
2. Let *declarations2* be [VarScopedDeclarations](#) of *CaseClause*.
3. Return the [list-concatenation](#) of *declarations1* and *declarations2*.

*CaseClause* : **case** *Expression* : *StatementList*<sub>opt</sub>

1. If the *StatementList* is present, return the [VarScopedDeclarations](#) of *StatementList*.
2. Return a new empty [List](#).

*DefaultClause* : **default** : *StatementList*<sub>opt</sub>

1. If the *StatementList* is present, return the [VarScopedDeclarations](#) of *StatementList*.
2. Return a new empty [List](#).

*LabelledStatement* : *LabelIdentifier* : *LabelledItem*

1. Return the [VarScopedDeclarations](#) of *LabelledItem*.

*LabelledItem* : *FunctionDeclaration*

1. Return a new empty [List](#).

*TryStatement* : **try** *Block* *Catch*

1. Let *declarations1* be [VarScopedDeclarations](#) of *Block*.
2. Let *declarations2* be [VarScopedDeclarations](#) of *Catch*.
3. Return the [list-concatenation](#) of *declarations1* and *declarations2*.

*TryStatement* : **try** *Block* *Finally*

1. Let *declarations1* be [VarScopedDeclarations](#) of *Block*.
2. Let *declarations2* be [VarScopedDeclarations](#) of *Finally*.
3. Return the [list-concatenation](#) of *declarations1* and *declarations2*.

*TryStatement* : **try** *Block* *Catch* *Finally*

1. Let *declarations1* be [VarScopedDeclarations](#) of *Block*.
2. Let *declarations2* be [VarScopedDeclarations](#) of *Catch*.
3. Let *declarations3* be [VarScopedDeclarations](#) of *Finally*.
4. Return the [list-concatenation](#) of *declarations1*, *declarations2*, and *declarations3*.

*Catch* : **catch** ( *CatchParameter* ) *Block*

1. Return the [VarScopedDeclarations](#) of *Block*.

*FunctionStatementList* : [empty]

1. Return a new empty [List](#).

*FunctionStatementList* : *StatementList*

1. Return the [TopLevelVarScopedDeclarations](#) of *StatementList*.

*ClassStaticBlockStatementList* : [empty]

1. Return a new empty [List](#).

*ClassStaticBlockStatementList* : *StatementList*

1. Return the [TopLevelVarScopedDeclarations](#) of *StatementList*.

*ConciseBody* : *ExpressionBody*

1. Return a new empty [List](#).

*AsyncConciseBody* : *ExpressionBody*

1. Return a new empty [List](#).

*Script* : [empty]

1. Return a new empty [List](#).

*ScriptBody* : *StatementList*

1. Return [TopLevelVarScopedDeclarations](#) of *StatementList*.

*Module* : [empty]

1. Return a new empty [List](#).

*ModuleItemList* : *ModuleItemList* *ModuleItem*

1. Let *declarations1* be [VarScopedDeclarations](#) of *ModuleItemList*.
2. Let *declarations2* be [VarScopedDeclarations](#) of *ModuleItem*.
3. Return the [list-concatenation](#) of *declarations1* and *declarations2*.

*ModuleItem* : *ImportDeclaration*

1. Return a new empty [List](#).

*ModuleItem* : *ExportDeclaration*

1. If *ExportDeclaration* is **export** *VariableStatement*, return [VarScopedDeclarations](#) of *VariableStatement*.
2. Return a new empty [List](#).

## 8.2.8 Static Semantics: TopLevelLexicallyDeclaredNames

The [syntax-directed operation](#) `TopLevelLexicallyDeclaredNames` takes no arguments and returns a [List](#) of Strings. It is defined piecewise over the following productions:

*StatementList* : *StatementList* *StatementListItem*

1. Let *names1* be [TopLevelLexicallyDeclaredNames](#) of *StatementList*.
2. Let *names2* be [TopLevelLexicallyDeclaredNames](#) of *StatementListItem*.
3. Return the [list-concatenation](#) of *names1* and *names2*.

*StatementListItem* : *Statement*

1. Return a new empty [List](#).

*StatementListItem* : *Declaration*

1. If *Declaration* is *Declaration* : *HoistableDeclaration* , then
  - a. Return a new empty [List](#).
2. Return the [BoundNames](#) of *Declaration*.

**NOTE** At the top level of a function, or script, function declarations are treated like var declarations rather than like lexical declarations.

## 8.2.9 Static Semantics: TopLevelLexicallyScopedDeclarations

The [syntax-directed operation](#) `TopLevelLexicallyScopedDeclarations` takes no arguments and returns a [List](#) of [Parse Nodes](#). It is defined piecewise over the following productions:

*StatementList* : *StatementList* *StatementListItem*

1. Let *declarations1* be [TopLevelLexicallyScopedDeclarations](#) of *StatementList*.
2. Let *declarations2* be [TopLevelLexicallyScopedDeclarations](#) of *StatementListItem*.
3. Return the [list-concatenation](#) of *declarations1* and *declarations2*.

*StatementListItem* : *Statement*

1. Return a new empty [List](#).

*StatementListItem* : *Declaration*

1. If *Declaration* is *Declaration* : *HoistableDeclaration* , then
  - a. Return a new empty [List](#).
2. Return « *Declaration* ».

## 8.2.10 Static Semantics: TopLevelVarDeclaredNames

The [syntax-directed operation](#) `TopLevelVarDeclaredNames` takes no arguments and returns a [List](#) of Strings. It is defined piecewise over the following productions:

*StatementList* : *StatementList* *StatementListItem*

1. Let *names1* be [TopLevelVarDeclaredNames](#) of *StatementList*.
2. Let *names2* be [TopLevelVarDeclaredNames](#) of *StatementListItem*.
3. Return the [list-concatenation](#) of *names1* and *names2*.

*StatementListItem* : *Declaration*

1. If *Declaration* is *Declaration* : *HoistableDeclaration* , then
  - a. Return the [BoundNames](#) of *HoistableDeclaration*.
2. Return a new empty [List](#).

*StatementListItem* : *Statement*

1. If *Statement* is *Statement* : *LabelledStatement* , return [TopLevelVarDeclaredNames](#) of *Statement*.
2. Return [VarDeclaredNames](#) of *Statement*.

**NOTE** At the top level of a function or script, inner function declarations are treated like var declarations.

*LabelledStatement* : *LabelIdentifier* : *LabelledItem*

1. Return the [TopLevelVarDeclaredNames](#) of *LabelledItem*.

*LabelledItem* : *Statement*

1. If *Statement* is *Statement* : *LabelledStatement* , return [TopLevelVarDeclaredNames](#) of *Statement*.
2. Return [VarDeclaredNames](#) of *Statement*.

*LabelledItem* : *FunctionDeclaration*

1. Return [BoundNames](#) of *FunctionDeclaration*.

## 8.2.11 Static Semantics: TopLevelVarScopedDeclarations

The [syntax-directed operation](#) `TopLevelVarScopedDeclarations` takes no arguments and returns a [List](#) of [Parse Nodes](#). It is defined piecewise over the following productions:

*StatementList* : *StatementList* *StatementListItem*

1. Let *declarations1* be [TopLevelVarScopedDeclarations](#) of *StatementList*.
2. Let *declarations2* be [TopLevelVarScopedDeclarations](#) of *StatementListItem*.
3. Return the [list-concatenation](#) of *declarations1* and *declarations2*.

*StatementListItem* : *Statement*

1. If *Statement* is *Statement* : *LabelledStatement* , return [TopLevelVarScopedDeclarations](#) of *Statement*.
2. Return [VarScopedDeclarations](#) of *Statement*.

*StatementListItem* : *Declaration*

1. If *Declaration* is *Declaration* : *HoistableDeclaration* , then
  - a. Let *declaration* be [DeclarationPart](#) of *HoistableDeclaration*.
  - b. Return « *declaration* ».
2. Return a new empty [List](#).

*LabelledStatement* : *LabelIdentifier* : *LabelledItem*

1. Return the [TopLevelVarScopedDeclarations](#) of *LabelledItem*.

*LabelledItem* : *Statement*

1. If *Statement* is *Statement* : *LabelledStatement* , return [TopLevelVarScopedDeclarations](#) of *Statement*.
2. Return [VarScopedDeclarations](#) of *Statement*.

*LabelledItem* : *FunctionDeclaration*

1. Return « *FunctionDeclaration* ».

## 8.3 Labels

### 8.3.1 Static Semantics: ContainsDuplicateLabels

The [syntax-directed operation](#) `ContainsDuplicateLabels` takes argument *labelSet* (a [List](#) of Strings) and returns a Boolean. It is defined piecewise over the following productions:

*Statement* :

*VariableStatement*  
*EmptyStatement*  
*ExpressionStatement*  
*ContinueStatement*  
*BreakStatement*  
*ReturnStatement*  
*ThrowStatement*  
*DebuggerStatement*

*Block* :

{ }

*StatementListItem* :

*Declaration*

1. Return **false**.

*StatementList* : *StatementList* *StatementListItem*

1. Let *hasDuplicates* be [ContainsDuplicateLabels](#) of *StatementList* with argument *labelSet*.
2. If *hasDuplicates* is **true**, return **true**.
3. Return [ContainsDuplicateLabels](#) of *StatementListItem* with argument *labelSet*.

*IfStatement* : **if** ( *Expression* ) *Statement* **else** *Statement*

1. Let *hasDuplicate* be [ContainsDuplicateLabels](#) of the first *Statement* with argument *labelSet*.
2. If *hasDuplicate* is **true**, return **true**.
3. Return [ContainsDuplicateLabels](#) of the second *Statement* with argument *labelSet*.

*IfStatement* : **if** ( *Expression* ) *Statement*

1. Return [ContainsDuplicateLabels](#) of *Statement* with argument *labelSet*.

*DoWhileStatement* : **do** *Statement* **while** ( *Expression* ) ;

1. Return [ContainsDuplicateLabels](#) of *Statement* with argument *labelSet*.

*WhileStatement* : **while** ( *Expression* ) *Statement*

1. Return [ContainsDuplicateLabels](#) of *Statement* with argument *labelSet*.

*ForStatement* :

**for** ( *Expression*<sub>opt</sub> ; *Expression*<sub>opt</sub> ; *Expression*<sub>opt</sub> ) *Statement*  
**for** ( **var** *VariableDeclarationList* ; *Expression*<sub>opt</sub> ; *Expression*<sub>opt</sub> ) *Statement*  
**for** ( *LexicalDeclaration* *Expression*<sub>opt</sub> ; *Expression*<sub>opt</sub> ) *Statement*

1. Return [ContainsDuplicateLabels](#) of *Statement* with argument *labelSet*.

*ForInOfStatement* :

**for** ( *LeftHandSideExpression* **in** *Expression* ) *Statement*  
**for** ( **var** *ForBinding* **in** *Expression* ) *Statement*  
**for** ( *ForDeclaration* **in** *Expression* ) *Statement*  
**for** ( *LeftHandSideExpression* **of** *AssignmentExpression* ) *Statement*  
**for** ( **var** *ForBinding* **of** *AssignmentExpression* ) *Statement*  
**for** ( *ForDeclaration* **of** *AssignmentExpression* ) *Statement*  
**for await** ( *LeftHandSideExpression* **of** *AssignmentExpression* ) *Statement*  
**for await** ( **var** *ForBinding* **of** *AssignmentExpression* ) *Statement*  
**for await** ( *ForDeclaration* **of** *AssignmentExpression* ) *Statement*

1. Return [ContainsDuplicateLabels](#) of *Statement* with argument *labelSet*.

**NOTE** This section is extended by Annex [B.3.5](#).

*WithStatement* : **with** ( *Expression* ) *Statement*

1. Return [ContainsDuplicateLabels](#) of *Statement* with argument *labelSet*.

*SwitchStatement* : **switch** ( *Expression* ) *CaseBlock*

1. Return [ContainsDuplicateLabels](#) of *CaseBlock* with argument *labelSet*.

*CaseBlock* : { }

1. Return **false**.

*CaseBlock* : { *CaseClauses*<sub>opt</sub> *DefaultClause* *CaseClauses*<sub>opt</sub> }



1. If the first *CaseClauses* is present, then
  - a. If *ContainsDuplicateLabels* of the first *CaseClauses* with argument *labelSet* is **true**, return **true**.
2. If *ContainsDuplicateLabels* of *DefaultClause* with argument *labelSet* is **true**, return **true**.
3. If the second *CaseClauses* is not present, return **false**.
4. Return *ContainsDuplicateLabels* of the second *CaseClauses* with argument *labelSet*.

*CaseClauses* : *CaseClauses* *CaseClause*

1. Let *hasDuplicates* be *ContainsDuplicateLabels* of *CaseClauses* with argument *labelSet*.
2. If *hasDuplicates* is **true**, return **true**.
3. Return *ContainsDuplicateLabels* of *CaseClause* with argument *labelSet*.

*CaseClause* : **case** *Expression* : *StatementList*<sub>opt</sub>

1. If the *StatementList* is present, return *ContainsDuplicateLabels* of *StatementList* with argument *labelSet*.
2. Return **false**.

*DefaultClause* : **default** : *StatementList*<sub>opt</sub>

1. If the *StatementList* is present, return *ContainsDuplicateLabels* of *StatementList* with argument *labelSet*.
2. Return **false**.

*LabelledStatement* : *LabelIdentifier* : *LabelledItem*

1. Let *label* be the *StringValue* of *LabelIdentifier*.
2. If *labelSet* contains *label*, return **true**.
3. Let *newLabelSet* be the *list-concatenation* of *labelSet* and « *label* ».
4. Return *ContainsDuplicateLabels* of *LabelledItem* with argument *newLabelSet*.

*LabelledItem* : *FunctionDeclaration*

1. Return **false**.

*TryStatement* : **try** *Block* *Catch*

1. Let *hasDuplicates* be *ContainsDuplicateLabels* of *Block* with argument *labelSet*.
2. If *hasDuplicates* is **true**, return **true**.
3. Return *ContainsDuplicateLabels* of *Catch* with argument *labelSet*.

*TryStatement* : **try** *Block* *Finally*

1. Let *hasDuplicates* be *ContainsDuplicateLabels* of *Block* with argument *labelSet*.
2. If *hasDuplicates* is **true**, return **true**.
3. Return *ContainsDuplicateLabels* of *Finally* with argument *labelSet*.

*TryStatement* : **try** *Block* *Catch* *Finally*

1. If *ContainsDuplicateLabels* of *Block* with argument *labelSet* is **true**, return **true**.
2. If *ContainsDuplicateLabels* of *Catch* with argument *labelSet* is **true**, return **true**.
3. Return *ContainsDuplicateLabels* of *Finally* with argument *labelSet*.

*Catch* : **catch** ( *CatchParameter* ) *Block*

1. Return *ContainsDuplicateLabels* of *Block* with argument *labelSet*.

*FunctionStatementList* : [empty]

1. Return **false**.

*ClassStaticBlockStatementList* : [empty]

1. Return **false**.

*ModuleItemList* : *ModuleItemList* *ModuleItem*

1. Let *hasDuplicates* be *ContainsDuplicateLabels* of *ModuleItemList* with argument *labelSet*.
2. If *hasDuplicates* is **true**, return **true**.
3. Return *ContainsDuplicateLabels* of *ModuleItem* with argument *labelSet*.

*ModuleItem* :

*ImportDeclaration*  
*ExportDeclaration*

1. Return **false**.

### 8.3.2 Static Semantics: *ContainsUndefinedBreakTarget*

The *syntax-directed operation* *ContainsUndefinedBreakTarget* takes argument *labelSet* (a *List* of Strings) and returns a Boolean. It is defined piecewise over the following productions:

*Statement* :

*VariableStatement*  
*EmptyStatement*  
*ExpressionStatement*  
*ContinueStatement*  
*ReturnStatement*  
*ThrowStatement*  
*DebuggerStatement*

*Block* :

{ }

*StatementListItem* :

*Declaration*

1. Return **false**.

*StatementList* : *StatementList* *StatementListItem*

1. Let *hasUndefinedLabels* be *ContainsUndefinedBreakTarget* of *StatementList* with argument *labelSet*.
2. If *hasUndefinedLabels* is **true**, return **true**.
3. Return *ContainsUndefinedBreakTarget* of *StatementListItem* with argument *labelSet*.

*IfStatement* : **if** ( *Expression* ) *Statement* **else** *Statement*

1. Let *hasUndefinedLabels* be *ContainsUndefinedBreakTarget* of the first *Statement* with argument *labelSet*.
2. If *hasUndefinedLabels* is **true**, return **true**.
3. Return *ContainsUndefinedBreakTarget* of the second *Statement* with argument *labelSet*.

*IfStatement* : **if** ( *Expression* ) *Statement*

1. Return *ContainsUndefinedBreakTarget* of *Statement* with argument *labelSet*.

*DoWhileStatement* : **do** *Statement* **while** ( *Expression* ) ;

1. Return [ContainsUndefinedBreakTarget](#) of *Statement* with argument *labelSet*.

*WhileStatement* : **while** ( *Expression* ) *Statement*

1. Return [ContainsUndefinedBreakTarget](#) of *Statement* with argument *labelSet*.

*ForStatement* :

**for** ( *Expression*<sub>opt</sub> ; *Expression*<sub>opt</sub> ; *Expression*<sub>opt</sub> ) *Statement*  
**for** ( **var** *VariableDeclarationList* ; *Expression*<sub>opt</sub> ; *Expression*<sub>opt</sub> ) *Statement*  
**for** ( *LexicalDeclaration* *Expression*<sub>opt</sub> ; *Expression*<sub>opt</sub> ) *Statement*

1. Return [ContainsUndefinedBreakTarget](#) of *Statement* with argument *labelSet*.

*ForInOfStatement* :

**for** ( *LeftHandSideExpression* **in** *Expression* ) *Statement*  
**for** ( **var** *ForBinding* **in** *Expression* ) *Statement*  
**for** ( *ForDeclaration* **in** *Expression* ) *Statement*  
**for** ( *LeftHandSideExpression* **of** *AssignmentExpression* ) *Statement*  
**for** ( **var** *ForBinding* **of** *AssignmentExpression* ) *Statement*  
**for** ( *ForDeclaration* **of** *AssignmentExpression* ) *Statement*  
**for await** ( *LeftHandSideExpression* **of** *AssignmentExpression* ) *Statement*  
**for await** ( **var** *ForBinding* **of** *AssignmentExpression* ) *Statement*  
**for await** ( *ForDeclaration* **of** *AssignmentExpression* ) *Statement*

1. Return [ContainsUndefinedBreakTarget](#) of *Statement* with argument *labelSet*.

**NOTE** This section is extended by Annex [B.3.5](#).

*BreakStatement* : **break** ;

1. Return **false**.

*BreakStatement* : **break** *LabelIdentifier* ;

1. If *labelSet* does not contain the [StringValue](#) of *LabelIdentifier*, return **true**.
2. Return **false**.

*WithStatement* : **with** ( *Expression* ) *Statement*

1. Return [ContainsUndefinedBreakTarget](#) of *Statement* with argument *labelSet*.

*SwitchStatement* : **switch** ( *Expression* ) *CaseBlock*

1. Return [ContainsUndefinedBreakTarget](#) of *CaseBlock* with argument *labelSet*.

*CaseBlock* : { }

1. Return **false**.

*CaseBlock* : { *CaseClauses*<sub>opt</sub> *DefaultClause* *CaseClauses*<sub>opt</sub> }

1. If the first *CaseClauses* is present, then
  - a. If *ContainsUndefinedBreakTarget* of the first *CaseClauses* with argument *labelSet* is **true**, return **true**.
2. If *ContainsUndefinedBreakTarget* of *DefaultClause* with argument *labelSet* is **true**, return **true**.
3. If the second *CaseClauses* is not present, return **false**.
4. Return *ContainsUndefinedBreakTarget* of the second *CaseClauses* with argument *labelSet*.

*CaseClauses* : *CaseClauses* *CaseClause*

1. Let *hasUndefinedLabels* be *ContainsUndefinedBreakTarget* of *CaseClauses* with argument *labelSet*.
2. If *hasUndefinedLabels* is **true**, return **true**.
3. Return *ContainsUndefinedBreakTarget* of *CaseClause* with argument *labelSet*.

*CaseClause* : **case** *Expression* : *StatementList*<sub>opt</sub>

1. If the *StatementList* is present, return *ContainsUndefinedBreakTarget* of *StatementList* with argument *labelSet*.
2. Return **false**.

*DefaultClause* : **default** : *StatementList*<sub>opt</sub>

1. If the *StatementList* is present, return *ContainsUndefinedBreakTarget* of *StatementList* with argument *labelSet*.
2. Return **false**.

*LabelledStatement* : *LabelIdentifier* : *LabelledItem*

1. Let *label* be the *StringValue* of *LabelIdentifier*.
2. Let *newLabelSet* be the *list-concatenation* of *labelSet* and « *label* ».
3. Return *ContainsUndefinedBreakTarget* of *LabelledItem* with argument *newLabelSet*.

*LabelledItem* : *FunctionDeclaration*

1. Return **false**.

*TryStatement* : **try** *Block* *Catch*

1. Let *hasUndefinedLabels* be *ContainsUndefinedBreakTarget* of *Block* with argument *labelSet*.
2. If *hasUndefinedLabels* is **true**, return **true**.
3. Return *ContainsUndefinedBreakTarget* of *Catch* with argument *labelSet*.

*TryStatement* : **try** *Block* *Finally*

1. Let *hasUndefinedLabels* be *ContainsUndefinedBreakTarget* of *Block* with argument *labelSet*.
2. If *hasUndefinedLabels* is **true**, return **true**.
3. Return *ContainsUndefinedBreakTarget* of *Finally* with argument *labelSet*.

*TryStatement* : **try** *Block* *Catch* *Finally*

1. If *ContainsUndefinedBreakTarget* of *Block* with argument *labelSet* is **true**, return **true**.
2. If *ContainsUndefinedBreakTarget* of *Catch* with argument *labelSet* is **true**, return **true**.
3. Return *ContainsUndefinedBreakTarget* of *Finally* with argument *labelSet*.

*Catch* : **catch** ( *CatchParameter* ) *Block*

1. Return *ContainsUndefinedBreakTarget* of *Block* with argument *labelSet*.

*FunctionStatementList* : [empty]

1. Return **false**.

*ClassStaticBlockStatementList* : [empty]

1. Return **false**.

*ModuleItemList* : *ModuleItemList* *ModuleItem*

1. Let *hasUndefinedLabels* be *ContainsUndefinedBreakTarget* of *ModuleItemList* with argument *labelSet*.
2. If *hasUndefinedLabels* is **true**, return **true**.
3. Return *ContainsUndefinedBreakTarget* of *ModuleItem* with argument *labelSet*.

*ModuleItem* :

*ImportDeclaration*  
*ExportDeclaration*

1. Return **false**.

### 8.3.3 Static Semantics: *ContainsUndefinedContinueTarget*

The *syntax-directed operation* *ContainsUndefinedContinueTarget* takes arguments *iterationSet* (a *List* of Strings) and *labelSet* (a *List* of Strings) and returns a Boolean. It is defined piecewise over the following productions:

*Statement* :

*VariableStatement*  
*EmptyStatement*  
*ExpressionStatement*  
*BreakStatement*  
*ReturnStatement*  
*ThrowStatement*  
*DebuggerStatement*

*Block* :

{ }

*StatementListItem* :

*Declaration*

1. Return **false**.

*Statement* : *BlockStatement*

1. Return *ContainsUndefinedContinueTarget* of *BlockStatement* with arguments *iterationSet* and « ».

*BreakableStatement* : *IterationStatement*

1. Let *newIterationSet* be the *list-concatenation* of *iterationSet* and *labelSet*.
2. Return *ContainsUndefinedContinueTarget* of *IterationStatement* with arguments *newIterationSet* and « ».

*StatementList* : *StatementList* *StatementListItem*

1. Let *hasUndefinedLabels* be *ContainsUndefinedContinueTarget* of *StatementList* with arguments *iterationSet* and « ».
2. If *hasUndefinedLabels* is **true**, return **true**.
3. Return *ContainsUndefinedContinueTarget* of *StatementListItem* with arguments *iterationSet* and « ».

*IfStatement* : **if** ( *Expression* ) *Statement* **else** *Statement*

1. Let *hasUndefinedLabels* be *ContainsUndefinedContinueTarget* of the first *Statement* with arguments *iterationSet* and « ».
2. If *hasUndefinedLabels* is **true**, return **true**.
3. Return *ContainsUndefinedContinueTarget* of the second *Statement* with arguments *iterationSet* and « ».

*IfStatement* : **if** ( *Expression* ) *Statement*

1. Return *ContainsUndefinedContinueTarget* of *Statement* with arguments *iterationSet* and « ».

*DoWhileStatement* : **do** *Statement* **while** ( *Expression* ) ;

1. Return *ContainsUndefinedContinueTarget* of *Statement* with arguments *iterationSet* and « ».

*WhileStatement* : **while** ( *Expression* ) *Statement*

1. Return *ContainsUndefinedContinueTarget* of *Statement* with arguments *iterationSet* and « ».

*ForStatement* :

**for** ( *Expression*<sub>opt</sub> ; *Expression*<sub>opt</sub> ; *Expression*<sub>opt</sub> ) *Statement*  
**for** ( **var** *VariableDeclarationList* ; *Expression*<sub>opt</sub> ; *Expression*<sub>opt</sub> ) *Statement*  
**for** ( *LexicalDeclaration* *Expression*<sub>opt</sub> ; *Expression*<sub>opt</sub> ) *Statement*

1. Return *ContainsUndefinedContinueTarget* of *Statement* with arguments *iterationSet* and « ».

*ForInOfStatement* :

**for** ( *LeftHandSideExpression* **in** *Expression* ) *Statement*  
**for** ( **var** *ForBinding* **in** *Expression* ) *Statement*  
**for** ( *ForDeclaration* **in** *Expression* ) *Statement*  
**for** ( *LeftHandSideExpression* **of** *AssignmentExpression* ) *Statement*  
**for** ( **var** *ForBinding* **of** *AssignmentExpression* ) *Statement*  
**for** ( *ForDeclaration* **of** *AssignmentExpression* ) *Statement*  
**for await** ( *LeftHandSideExpression* **of** *AssignmentExpression* ) *Statement*  
**for await** ( **var** *ForBinding* **of** *AssignmentExpression* ) *Statement*  
**for await** ( *ForDeclaration* **of** *AssignmentExpression* ) *Statement*

1. Return *ContainsUndefinedContinueTarget* of *Statement* with arguments *iterationSet* and « ».

**NOTE** This section is extended by Annex B.3.5.

*ContinueStatement* : **continue** ;

1. Return **false**.

*ContinueStatement* : **continue** *LabelIdentifier* ;

1. If *iterationSet* does not contain the *StringValue* of *LabelIdentifier*, return **true**.
2. Return **false**.

*WithStatement* : **with** ( *Expression* ) *Statement*

1. Return *ContainsUndefinedContinueTarget* of *Statement* with arguments *iterationSet* and « ».

*SwitchStatement* : **switch** ( *Expression* ) *CaseBlock*

1. Return *ContainsUndefinedContinueTarget* of *CaseBlock* with arguments *iterationSet* and « ».

*CaseBlock* : { }

1. Return **false**.

*CaseBlock* : { *CaseClauses*<sub>opt</sub> *DefaultClause* *CaseClauses*<sub>opt</sub> }

1. If the first *CaseClauses* is present, then
  - a. If *ContainsUndefinedContinueTarget* of the first *CaseClauses* with arguments *iterationSet* and « » is **true**, return **true**.
2. If *ContainsUndefinedContinueTarget* of *DefaultClause* with arguments *iterationSet* and « » is **true**, return **true**.
3. If the second *CaseClauses* is not present, return **false**.
4. Return *ContainsUndefinedContinueTarget* of the second *CaseClauses* with arguments *iterationSet* and « ».

*CaseClauses* : *CaseClauses* *CaseClause*

1. Let *hasUndefinedLabels* be *ContainsUndefinedContinueTarget* of *CaseClauses* with arguments *iterationSet* and « ».
2. If *hasUndefinedLabels* is **true**, return **true**.
3. Return *ContainsUndefinedContinueTarget* of *CaseClause* with arguments *iterationSet* and « ».

*CaseClause* : **case** *Expression* : *StatementList*<sub>opt</sub>

1. If the *StatementList* is present, return *ContainsUndefinedContinueTarget* of *StatementList* with arguments *iterationSet* and « ».
2. Return **false**.

*DefaultClause* : **default** : *StatementList*<sub>opt</sub>

1. If the *StatementList* is present, return *ContainsUndefinedContinueTarget* of *StatementList* with arguments *iterationSet* and « ».
2. Return **false**.

*LabelledStatement* : *LabelIdentifier* : *LabelledItem*

1. Let *label* be the *StringValue* of *LabelIdentifier*.
2. Let *newLabelSet* be the list-concatenation of *labelSet* and « *label* ».
3. Return *ContainsUndefinedContinueTarget* of *LabelledItem* with arguments *iterationSet* and *newLabelSet*.

*LabelledItem* : *FunctionDeclaration*

1. Return **false**.

*TryStatement* : **try** *Block* *Catch*

1. Let *hasUndefinedLabels* be *ContainsUndefinedContinueTarget* of *Block* with arguments *iterationSet* and « ».
2. If *hasUndefinedLabels* is **true**, return **true**.
3. Return *ContainsUndefinedContinueTarget* of *Catch* with arguments *iterationSet* and « ».

*TryStatement* : **try** *Block* *Finally*

1. Let *hasUndefinedLabels* be *ContainsUndefinedContinueTarget* of *Block* with arguments *iterationSet* and « ».
2. If *hasUndefinedLabels* is **true**, return **true**.

- Return `ContainsUndefinedContinueTarget` of `Finally` with arguments `iterationSet` and « ».

*TryStatement* : **try** *Block* *Catch* *Finally*

- If `ContainsUndefinedContinueTarget` of `Block` with arguments `iterationSet` and « » is **true**, return **true**.
- If `ContainsUndefinedContinueTarget` of `Catch` with arguments `iterationSet` and « » is **true**, return **true**.
- Return `ContainsUndefinedContinueTarget` of `Finally` with arguments `iterationSet` and « ».

*Catch* : **catch** ( *CatchParameter* ) *Block*

- Return `ContainsUndefinedContinueTarget` of `Block` with arguments `iterationSet` and « ».

*FunctionStatementList* : [empty]

- Return **false**.

*ClassStaticBlockStatementList* : [empty]

- Return **false**.

*ModuleItemList* : *ModuleItemList* *ModuleItem*

- Let `hasUndefinedLabels` be `ContainsUndefinedContinueTarget` of `ModuleItemList` with arguments `iterationSet` and « ».
- If `hasUndefinedLabels` is **true**, return **true**.
- Return `ContainsUndefinedContinueTarget` of `ModuleItem` with arguments `iterationSet` and « ».

*ModuleItem* :

*ImportDeclaration*

*ExportDeclaration*

- Return **false**.

## 8.4 Function Name Inference

### 8.4.1 Static Semantics: HasName

The [syntax-directed operation](#) `HasName` takes no arguments and returns a Boolean. It is defined piecewise over the following productions:

*PrimaryExpression* : *CoverParenthesizedExpressionAndArrowParameterList*

- Let `expr` be the *ParenthesizedExpression* that is [covered](#) by *CoverParenthesizedExpressionAndArrowParameterList*.
- If `isFunctionDefinition` of `expr` is **false**, return **false**.
- Return `HasName` of `expr`.

*FunctionExpression* :

**function** ( *FormalParameters* ) { *FunctionBody* }

*GeneratorExpression* :

**function** \* ( *FormalParameters* ) { *GeneratorBody* }

*AsyncGeneratorExpression* :

**async function** \* ( *FormalParameters* ) { *AsyncGeneratorBody* }

*AsyncFunctionExpression* :

**async function** ( *FormalParameters* ) { *AsyncFunctionBody* }

*ArrowFunction* :

*ArrowParameters* => *ConciseBody*



*AsyncArrowFunction* :

**async** *AsyncArrowBindingIdentifier* => *AsyncConciseBody*  
*CoverCallExpressionAndAsyncArrowHead* => *AsyncConciseBody*

*ClassExpression* :

**class** *ClassTail*

1. Return **false**.

*FunctionExpression* :

**function** *BindingIdentifier* ( *FormalParameters* ) { *FunctionBody* }

*GeneratorExpression* :

**function** \* *BindingIdentifier* ( *FormalParameters* ) { *GeneratorBody* }

*AsyncGeneratorExpression* :

**async function** \* *BindingIdentifier* ( *FormalParameters* ) { *AsyncGeneratorBody* }

*AsyncFunctionExpression* :

**async function** *BindingIdentifier* ( *FormalParameters* ) { *AsyncFunctionBody* }

*ClassExpression* :

**class** *BindingIdentifier* *ClassTail*

1. Return **true**.

## 8.4.2 Static Semantics: IsFunctionDefinition

The [syntax-directed operation](#) `IsFunctionDefinition` takes no arguments and returns a Boolean. It is defined piecewise over the following productions:

*PrimaryExpression* : *CoverParenthesizedExpressionAndArrowParameterList*

1. Let *expr* be the *ParenthesizedExpression* that is [covered](#) by *CoverParenthesizedExpressionAndArrowParameterList*.
2. Return [IsFunctionDefinition](#) of *expr*.

*PrimaryExpression* :

**this**  
*IdentifierReference*  
*Literal*  
*ArrayLiteral*  
*ObjectLiteral*  
*RegularExpressionLiteral*  
*TemplateLiteral*

*MemberExpression* :

*MemberExpression* [ *Expression* ]  
*MemberExpression* . *IdentifierName*  
*MemberExpression* *TemplateLiteral*  
*SuperProperty*  
*MetaProperty*  
**new** *MemberExpression* *Arguments*  
*MemberExpression* . *PrivateIdentifier*

*NewExpression* :

**new** *NewExpression*

*LeftHandSideExpression* :

*CallExpression*  
*OptionalExpression*

*UpdateExpression* :

*LeftHandSideExpression* ++  
*LeftHandSideExpression* --  
++ *UnaryExpression*

-- UnaryExpression

UnaryExpression :

- delete** UnaryExpression
- void** UnaryExpression
- typeof** UnaryExpression
- +** UnaryExpression
- UnaryExpression
- UnaryExpression
- !** UnaryExpression
- AwaitExpression

ExponentiationExpression :

- UpdateExpression \*\* ExponentiationExpression

MultiplicativeExpression :

- MultiplicativeExpression MultiplicativeOperator ExponentiationExpression

AdditiveExpression :

- AdditiveExpression + MultiplicativeExpression
- AdditiveExpression - MultiplicativeExpression

ShiftExpression :

- ShiftExpression << AdditiveExpression
- ShiftExpression >> AdditiveExpression
- ShiftExpression >>> AdditiveExpression

RelationalExpression :

- RelationalExpression < ShiftExpression
- RelationalExpression > ShiftExpression
- RelationalExpression <= ShiftExpression
- RelationalExpression >= ShiftExpression
- RelationalExpression **instanceof** ShiftExpression
- RelationalExpression **in** ShiftExpression
- PrivateIdentifier **in** ShiftExpression

EqualityExpression :

- EqualityExpression == RelationalExpression
- EqualityExpression != RelationalExpression
- EqualityExpression === RelationalExpression
- EqualityExpression !== RelationalExpression

BitwiseANDExpression :

- BitwiseANDExpression & EqualityExpression

BitwiseXORExpression :

- BitwiseXORExpression ^ BitwiseANDExpression

BitwiseORExpression :

- BitwiseORExpression | BitwiseXORExpression

LogicalANDExpression :

- LogicalANDExpression && BitwiseORExpression

LogicalORExpression :

- LogicalORExpression || LogicalANDExpression

CoalesceExpression :

- CoalesceExpressionHead ?? BitwiseORExpression

ConditionalExpression :

- ShortCircuitExpression ? AssignmentExpression : AssignmentExpression

AssignmentExpression :

- YieldExpression
- LeftHandSideExpression = AssignmentExpression
- LeftHandSideExpression AssignmentOperator AssignmentExpression
- LeftHandSideExpression &&= AssignmentExpression
- LeftHandSideExpression ||= AssignmentExpression
- LeftHandSideExpression ??= AssignmentExpression

Expression :

- Expression , AssignmentExpression

1. Return **false**.

*AssignmentExpression* :

*ArrowFunction*

*AsyncArrowFunction*

*FunctionExpression* :

**function** *BindingIdentifier*<sub>opt</sub> ( *FormalParameters* ) { *FunctionBody* }

*GeneratorExpression* :

**function** \* *BindingIdentifier*<sub>opt</sub> ( *FormalParameters* ) { *GeneratorBody* }

*AsyncGeneratorExpression* :

**async function** \* *BindingIdentifier*<sub>opt</sub> ( *FormalParameters* ) { *AsyncGeneratorBody* }

*AsyncFunctionExpression* :

**async function** *BindingIdentifier*<sub>opt</sub> ( *FormalParameters* ) { *AsyncFunctionBody* }

*ClassExpression* :

**class** *BindingIdentifier*<sub>opt</sub> *ClassTail*

1. Return **true**.

### 8.4.3 Static Semantics: IsAnonymousFunctionDefinition ( *expr* )

The abstract operation `IsAnonymousFunctionDefinition` takes argument *expr* (an *AssignmentExpression Parse Node* or an *Initializer Parse Node*) and returns a Boolean. It determines if its argument is a function definition that does not bind a name. It performs the following steps when called:

1. If `IsFunctionDefinition` of *expr* is **false**, return **false**.
2. Let *hasName* be `HasName` of *expr*.
3. If *hasName* is **true**, return **false**.
4. Return **true**.

### 8.4.4 Static Semantics: IsIdentifierRef

The *syntax-directed operation* `IsIdentifierRef` takes no arguments and returns a Boolean. It is defined piecewise over the following productions:

*PrimaryExpression* : *IdentifierReference*

1. Return **true**.

*PrimaryExpression* :

**this**

*Literal*

*ArrayLiteral*

*ObjectLiteral*

*FunctionExpression*

*ClassExpression*

*GeneratorExpression*

*AsyncFunctionExpression*

*AsyncGeneratorExpression*

*RegularExpressionLiteral*

*TemplateLiteral*

*CoverParenthesizedExpressionAndArrowParameterList*

*MemberExpression* :

*MemberExpression* [ *Expression* ]

*MemberExpression* . *IdentifierName*

*MemberExpression TemplateLiteral*  
*SuperProperty*  
*MetaProperty*  
**new** *MemberExpression Arguments*  
*MemberExpression . PrivateIdentifier*

*NewExpression* :  
**new** *NewExpression*

*LeftHandSideExpression* :  
*CallExpression*  
*OptionalExpression*

1. Return **false**.

### 8.4.5 Runtime Semantics: NamedEvaluation

The [syntax-directed operation](#) `NamedEvaluation` takes argument *name* (a [property key](#) or a [Private Name](#)) and returns either a [normal completion](#) containing a [function object](#) or an [abrupt completion](#). It is defined piecewise over the following productions:

*PrimaryExpression* : *CoverParenthesizedExpressionAndArrowParameterList*

1. Let *expr* be the *ParenthesizedExpression* that is [covered](#) by *CoverParenthesizedExpressionAndArrowParameterList*.
2. Return ? [NamedEvaluation](#) of *expr* with argument *name*.

*ParenthesizedExpression* : ( *Expression* )

1. [Assert: IsAnonymousFunctionDefinition\(Expression\)](#) is **true**.
2. Return ? [NamedEvaluation](#) of *Expression* with argument *name*.

*FunctionExpression* : **function** ( *FormalParameters* ) { *FunctionBody* }

1. Return [InstantiateOrdinaryFunctionExpression](#) of *FunctionExpression* with argument *name*.

*GeneratorExpression* : **function** \* ( *FormalParameters* ) { *GeneratorBody* }

1. Return [InstantiateGeneratorFunctionExpression](#) of *GeneratorExpression* with argument *name*.

*AsyncGeneratorExpression* : **async function** \* ( *FormalParameters* ) { *AsyncGeneratorBody* }

1. Return [InstantiateAsyncGeneratorFunctionExpression](#) of *AsyncGeneratorExpression* with argument *name*.

*AsyncFunctionExpression* : **async function** ( *FormalParameters* ) { *AsyncFunctionBody* }

1. Return [InstantiateAsyncFunctionExpression](#) of *AsyncFunctionExpression* with argument *name*.

*ArrowFunction* : *ArrowParameters* => *ConciseBody*

1. Return [InstantiateArrowFunctionExpression](#) of *ArrowFunction* with argument *name*.

*AsyncArrowFunction* :

**async** *AsyncArrowBindingIdentifier* => *AsyncConciseBody*  
*CoverCallExpressionAndAsyncArrowHead* => *AsyncConciseBody*

1. Return [InstantiateAsyncArrowFunctionExpression](#) of *AsyncArrowFunction* with argument *name*.

*ClassExpression* : **class** *ClassTail*

1. Let *value* be ? *ClassDefinitionEvaluation* of *ClassTail* with arguments **undefined** and *name*.
2. Set *value*.[[SourceText]] to the *source text matched by ClassExpression*.
3. Return *value*.

## 8.5 Contains

### 8.5.1 Static Semantics: Contains

The *syntax-directed operation* *Contains* takes argument *symbol* (a grammar symbol) and returns a Boolean.

Every grammar production alternative in this specification which is not listed below implicitly has the following default definition of *Contains*:

1. For each child node *child* of this *Parse Node*, do
  - a. If *child* is an instance of *symbol*, return **true**.
  - b. If *child* is an instance of a nonterminal, then
    - i. Let *contained* be the result of *child Contains symbol*.
    - ii. If *contained* is **true**, return **true**.
2. Return **false**.

*FunctionDeclaration* :

**function** *BindingIdentifier* ( *FormalParameters* ) { *FunctionBody* }

**function** ( *FormalParameters* ) { *FunctionBody* }

*FunctionExpression* :

**function** *BindingIdentifier*<sub>opt</sub> ( *FormalParameters* ) { *FunctionBody* }

*GeneratorDeclaration* :

**function** \* *BindingIdentifier* ( *FormalParameters* ) { *GeneratorBody* }

**function** \* ( *FormalParameters* ) { *GeneratorBody* }

*GeneratorExpression* :

**function** \* *BindingIdentifier*<sub>opt</sub> ( *FormalParameters* ) { *GeneratorBody* }

*AsyncGeneratorDeclaration* :

**async function** \* *BindingIdentifier* ( *FormalParameters* ) { *AsyncGeneratorBody* }

**async function** \* ( *FormalParameters* ) { *AsyncGeneratorBody* }

*AsyncGeneratorExpression* :

**async function** \* *BindingIdentifier*<sub>opt</sub> ( *FormalParameters* ) { *AsyncGeneratorBody* }

*AsyncFunctionDeclaration* :

**async function** *BindingIdentifier* ( *FormalParameters* ) { *AsyncFunctionBody* }

**async function** ( *FormalParameters* ) { *AsyncFunctionBody* }

*AsyncFunctionExpression* :

**async function** *BindingIdentifier*<sub>opt</sub> ( *FormalParameters* ) { *AsyncFunctionBody* }

1. Return **false**.

**NOTE 1** Static semantic rules that depend upon substructure generally do not look into function definitions.

*ClassTail* : *ClassHeritage*<sub>opt</sub> { *ClassBody* }

1. If *symbol* is *ClassBody*, return **true**.
2. If *symbol* is *ClassHeritage*, then
  - a. If *ClassHeritage* is present, return **true**; otherwise return **false**.
3. If *ClassHeritage* is present, then

- a. If *ClassHeritage Contains symbol* is **true**, return **true**.
4. Return the result of *ComputedPropertyContains* of *ClassBody* with argument *symbol*.

NOTE 2 Static semantic rules that depend upon substructure generally do not look into class bodies except for *PropertyNames*.

*ClassStaticBlock* : **static** { *ClassStaticBlockBody* }

1. Return **false**.

NOTE 3 Static semantic rules that depend upon substructure generally do not look into **static** initialization blocks.

*ArrowFunction* : *ArrowParameters* => *ConciseBody*

1. If *symbol* is not one of *NewTarget*, *SuperProperty*, *SuperCall*, **super**, or **this**, return **false**.
2. If *ArrowParameters Contains symbol* is **true**, return **true**.
3. Return *ConciseBody Contains symbol*.

*ArrowParameters* : *CoverParenthesizedExpressionAndArrowParameterList*

1. Let *formals* be the *ArrowFormalParameters* that is *covered* by *CoverParenthesizedExpressionAndArrowParameterList*.
2. Return *formals Contains symbol*.

*AsyncArrowFunction* : **async** *AsyncArrowBindingIdentifier* => *AsyncConciseBody*

1. If *symbol* is not one of *NewTarget*, *SuperProperty*, *SuperCall*, **super**, or **this**, return **false**.
2. Return *AsyncConciseBody Contains symbol*.

*AsyncArrowFunction* : *CoverCallExpressionAndAsyncArrowHead* => *AsyncConciseBody*

1. If *symbol* is not one of *NewTarget*, *SuperProperty*, *SuperCall*, **super**, or **this**, return **false**.
2. Let *head* be the *AsyncArrowHead* that is *covered* by *CoverCallExpressionAndAsyncArrowHead*.
3. If *head Contains symbol* is **true**, return **true**.
4. Return *AsyncConciseBody Contains symbol*.

NOTE 4 *Contains* is used to detect **new.target**, **this**, and **super** usage within an *ArrowFunction* or *AsyncArrowFunction*.

*PropertyDefinition* : *MethodDefinition*

1. If *symbol* is *MethodDefinition*, return **true**.
2. Return the result of *ComputedPropertyContains* of *MethodDefinition* with argument *symbol*.

*LiteralPropertyName* : *IdentifierName*

1. Return **false**.

*MemberExpression* : *MemberExpression* . *IdentifierName*

1. If *MemberExpression Contains symbol* is **true**, return **true**.
2. Return **false**.

*SuperProperty* : **super** . *IdentifierName*

1. If *symbol* is the *ReservedWord* **super**, return **true**.
2. Return **false**.

*CallExpression* : *CallExpression* . *IdentifierName*

1. If *CallExpression* **Contains** *symbol* is **true**, return **true**.
2. Return **false**.

*OptionalChain* : ? . *IdentifierName*

1. Return **false**.

*OptionalChain* : *OptionalChain* . *IdentifierName*

1. If *OptionalChain* **Contains** *symbol* is **true**, return **true**.
2. Return **false**.

## 8.5.2 Static Semantics: ComputedPropertyContains

The *syntax-directed operation* *ComputedPropertyContains* takes argument *symbol* (a grammar symbol) and returns a Boolean. It is defined piecewise over the following productions:

*ClassElementName* : *PrivateIdentifier*

*PropertyName* : *LiteralPropertyName*

1. Return **false**.

*PropertyName* : *ComputedPropertyName*

1. Return the result of *ComputedPropertyName* **Contains** *symbol*.

*MethodDefinition* :

*ClassElementName* ( *UniqueFormalParameters* ) { *FunctionBody* }

**get** *ClassElementName* ( ) { *FunctionBody* }

**set** *ClassElementName* ( *PropertySetParameterList* ) { *FunctionBody* }

1. Return the result of *ComputedPropertyContains* of *ClassElementName* with argument *symbol*.

*GeneratorMethod* : \* *ClassElementName* ( *UniqueFormalParameters* ) { *GeneratorBody* }

1. Return the result of *ComputedPropertyContains* of *ClassElementName* with argument *symbol*.

*AsyncGeneratorMethod* : **async** \* *ClassElementName* ( *UniqueFormalParameters* ) { *AsyncGeneratorBody* }

1. Return the result of *ComputedPropertyContains* of *ClassElementName* with argument *symbol*.

*ClassElementList* : *ClassElementList* *ClassElement*

1. Let *inList* be *ComputedPropertyContains* of *ClassElementList* with argument *symbol*.
2. If *inList* is **true**, return **true**.
3. Return the result of *ComputedPropertyContains* of *ClassElement* with argument *symbol*.

*ClassElement* : *ClassStaticBlock*

1. Return **false**.

*ClassElement* : ;

1. Return **false**.

*AsyncMethod* : **async** *ClassElementName* ( *UniqueFormalParameters* ) { *AsyncFunctionBody* }

1. Return the result of [ComputedPropertyContains](#) of *ClassElementName* with argument *symbol*.

*FieldDefinition* : *ClassElementName* *Initializer*<sub>opt</sub>

1. Return the result of [ComputedPropertyContains](#) of *ClassElementName* with argument *symbol*.

## 8.6 Miscellaneous

These operations are used in multiple places throughout the specification.

### 8.6.1 Runtime Semantics: InstantiateFunctionObject

The [syntax-directed operation](#) [InstantiateFunctionObject](#) takes arguments *env* (an [Environment Record](#)) and *privateEnv* (a [PrivateEnvironment Record](#) or **null**) and returns a [function object](#). It is defined piecewise over the following productions:

*FunctionDeclaration* :

```
function BindingIdentifier ( FormalParameters ) { FunctionBody }
function ( FormalParameters ) { FunctionBody }
```

1. Return [InstantiateOrdinaryFunctionObject](#) of *FunctionDeclaration* with arguments *env* and *privateEnv*.

*GeneratorDeclaration* :

```
function * BindingIdentifier ( FormalParameters ) { GeneratorBody }
function * ( FormalParameters ) { GeneratorBody }
```

1. Return [InstantiateGeneratorFunctionObject](#) of *GeneratorDeclaration* with arguments *env* and *privateEnv*.

*AsyncGeneratorDeclaration* :

```
async function * BindingIdentifier ( FormalParameters ) { AsyncGeneratorBody }
async function * ( FormalParameters ) { AsyncGeneratorBody }
```

1. Return [InstantiateAsyncGeneratorFunctionObject](#) of *AsyncGeneratorDeclaration* with arguments *env* and *privateEnv*.

*AsyncFunctionDeclaration* :

```
async function BindingIdentifier ( FormalParameters ) { AsyncFunctionBody }
async function ( FormalParameters ) { AsyncFunctionBody }
```

1. Return [InstantiateAsyncFunctionObject](#) of *AsyncFunctionDeclaration* with arguments *env* and *privateEnv*.

### 8.6.2 Runtime Semantics: BindingInitialization

The [syntax-directed operation](#) [BindingInitialization](#) takes arguments *value* (an [ECMAScript language value](#)) and *environment* (an [Environment Record](#) or **undefined**) and returns either a [normal completion](#) containing unused or an [abrupt completion](#).



**NOTE** **undefined** is passed for *environment* to indicate that a **PutValue** operation should be used to assign the initialization value. This is the case for **var** statements and formal parameter lists of some **non-strict functions** (See 10.2.11). In those cases a lexical binding is hoisted and preinitialized prior to evaluation of its initializer.

It is defined piecewise over the following productions:

*BindingIdentifier* : *Identifier*

1. Let *name* be **StringValue** of *Identifier*.
2. Return ? **InitializeBoundName**(*name*, *value*, *environment*).

*BindingIdentifier* : **yield**

1. Return ? **InitializeBoundName**("yield", *value*, *environment*).

*BindingIdentifier* : **await**

1. Return ? **InitializeBoundName**("await", *value*, *environment*).

*BindingPattern* : *ObjectBindingPattern*

1. Perform ? **RequireObjectCoercible**(*value*).
2. Return ? **BindingInitialization** of *ObjectBindingPattern* with arguments *value* and *environment*.

*BindingPattern* : *ArrayBindingPattern*

1. Let *iteratorRecord* be ? **GetIterator**(*value*, sync).
2. Let *result* be **Completion**(**IteratorBindingInitialization** of *ArrayBindingPattern* with arguments *iteratorRecord* and *environment*).
3. If *iteratorRecord*.[[Done]] is **false**, return ? **IteratorClose**(*iteratorRecord*, *result*).
4. Return ? *result*.

*ObjectBindingPattern* : { }

1. Return unused.

*ObjectBindingPattern* :

```
{ BindingPropertyList }
{ BindingPropertyList , }
```

1. Perform ? **PropertyBindingInitialization** of *BindingPropertyList* with arguments *value* and *environment*.
2. Return unused.

*ObjectBindingPattern* : { *BindingRestProperty* }

1. Let *excludedNames* be a new empty **List**.
2. Return ? **RestBindingInitialization** of *BindingRestProperty* with arguments *value*, *environment*, and *excludedNames*.

*ObjectBindingPattern* : { *BindingPropertyList* , *BindingRestProperty* }

1. Let *excludedNames* be ? **PropertyBindingInitialization** of *BindingPropertyList* with arguments *value* and *environment*.
2. Return ? **RestBindingInitialization** of *BindingRestProperty* with arguments *value*, *environment*, and *excludedNames*.

### 8.6.2.1 InitializeBoundName ( *name*, *value*, *environment* )

The abstract operation InitializeBoundName takes arguments *name* (a String), *value* (an ECMAScript language value), and *environment* (an Environment Record or **undefined**) and returns either a normal completion containing unused or an abrupt completion. It performs the following steps when called:

1. If *environment* is not **undefined**, then
  - a. Perform ! *environment*.InitializeBinding(*name*, *value*).
  - b. Return unused.
2. Else,
  - a. Let *lhs* be ? ResolveBinding(*name*).
  - b. Return ? PutValue(*lhs*, *value*).

### 8.6.3 Runtime Semantics: IteratorBindingInitialization

The syntax-directed operation IteratorBindingInitialization takes arguments *iteratorRecord* (an Iterator Record) and *environment* (an Environment Record or **undefined**) and returns either a normal completion containing unused or an abrupt completion.

**NOTE** When **undefined** is passed for *environment* it indicates that a PutValue operation should be used to assign the initialization value. This is the case for formal parameter lists of non-strict functions. In that case the formal parameter bindings are preinitialized in order to deal with the possibility of multiple parameters with the same name.

It is defined piecewise over the following productions:

*ArrayBindingPattern* : [ ]

1. Return unused.

*ArrayBindingPattern* : [ *Elision* ]

1. Return ? IteratorDestructuringAssignmentEvaluation of *Elision* with argument *iteratorRecord*.

*ArrayBindingPattern* : [ *Elision*<sub>opt</sub> *BindingRestElement* ]

1. If *Elision* is present, then
  - a. Perform ? IteratorDestructuringAssignmentEvaluation of *Elision* with argument *iteratorRecord*.
2. Return ? IteratorBindingInitialization of *BindingRestElement* with arguments *iteratorRecord* and *environment*.

*ArrayBindingPattern* : [ *BindingElementList* , *Elision* ]

1. Perform ? IteratorBindingInitialization of *BindingElementList* with arguments *iteratorRecord* and *environment*.
2. Return ? IteratorDestructuringAssignmentEvaluation of *Elision* with argument *iteratorRecord*.

*ArrayBindingPattern* : [ *BindingElementList* , *Elision*<sub>opt</sub> *BindingRestElement* ]

1. Perform ? IteratorBindingInitialization of *BindingElementList* with arguments *iteratorRecord* and *environment*.
2. If *Elision* is present, then
  - a. Perform ? IteratorDestructuringAssignmentEvaluation of *Elision* with argument *iteratorRecord*.

3. Return ? *IteratorBindingInitialization* of *BindingRestElement* with arguments *iteratorRecord* and *environment*.

*BindingElementList* : *BindingElementList* , *BindingElisionElement*

1. Perform ? *IteratorBindingInitialization* of *BindingElementList* with arguments *iteratorRecord* and *environment*.
2. Return ? *IteratorBindingInitialization* of *BindingElisionElement* with arguments *iteratorRecord* and *environment*.

*BindingElisionElement* : *Elision BindingElement*

1. Perform ? *IteratorDestructuringAssignmentEvaluation* of *Elision* with argument *iteratorRecord*.
2. Return ? *IteratorBindingInitialization* of *BindingElement* with arguments *iteratorRecord* and *environment*.

*SingleNameBinding* : *BindingIdentifier Initializer*<sub>opt</sub>

1. Let *bindingId* be *StringValue* of *BindingIdentifier*.
2. Let *lhs* be ? *ResolveBinding*(*bindingId*, *environment*).
3. Let *v* be **undefined**.
4. If *iteratorRecord*.[[Done]] is **false**, then
  - a. Let *next* be *Completion*(*IteratorStep*(*iteratorRecord*)).
  - b. If *next* is an **abrupt completion**, set *iteratorRecord*.[[Done]] to **true**.
  - c. *ReturnIfAbrupt*(*next*).
  - d. If *next* is **false**, set *iteratorRecord*.[[Done]] to **true**.
  - e. Else,
    - i. Set *v* to *Completion*(*IteratorValue*(*next*)).
    - ii. If *v* is an **abrupt completion**, set *iteratorRecord*.[[Done]] to **true**.
    - iii. *ReturnIfAbrupt*(*v*).
5. If *Initializer* is present and *v* is **undefined**, then
  - a. If *IsAnonymousFunctionDefinition*(*Initializer*) is **true**, then
    - i. Set *v* to ? *NamedEvaluation* of *Initializer* with argument *bindingId*.
  - b. Else,
    - i. Let *defaultValue* be ? *Evaluation* of *Initializer*.
    - ii. Set *v* to ? *GetValue*(*defaultValue*).
6. If *environment* is **undefined**, return ? *PutValue*(*lhs*, *v*).
7. Return ? *InitializeReferencedBinding*(*lhs*, *v*).

*BindingElement* : *BindingPattern Initializer*<sub>opt</sub>

1. Let *v* be **undefined**.
2. If *iteratorRecord*.[[Done]] is **false**, then
  - a. Let *next* be *Completion*(*IteratorStep*(*iteratorRecord*)).
  - b. If *next* is an **abrupt completion**, set *iteratorRecord*.[[Done]] to **true**.
  - c. *ReturnIfAbrupt*(*next*).
  - d. If *next* is **false**, set *iteratorRecord*.[[Done]] to **true**.
  - e. Else,
    - i. Set *v* to *Completion*(*IteratorValue*(*next*)).
    - ii. If *v* is an **abrupt completion**, set *iteratorRecord*.[[Done]] to **true**.
    - iii. *ReturnIfAbrupt*(*v*).

3. If *Initializer* is present and *v* is **undefined**, then
  - a. Let *defaultValue* be ? *Evaluation* of *Initializer*.
  - b. Set *v* to ? *GetValue*(*defaultValue*).
4. Return ? *BindingInitialization* of *BindingPattern* with arguments *v* and *environment*.

*BindingRestElement* : . . . *BindingIdentifier*

1. Let *lhs* be ? *ResolveBinding*(*StringValue* of *BindingIdentifier*, *environment*).
2. Let *A* be ! *ArrayCreate*(0).
3. Let *n* be 0.
4. Repeat,
  - a. If *iteratorRecord*.[[Done]] is **false**, then
    - i. Let *next* be *Completion*(*IteratorStep*(*iteratorRecord*)).
    - ii. If *next* is an abrupt completion, set *iteratorRecord*.[[Done]] to **true**.
    - iii. *ReturnIfAbrupt*(*next*).
    - iv. If *next* is **false**, set *iteratorRecord*.[[Done]] to **true**.
  - b. If *iteratorRecord*.[[Done]] is **true**, then
    - i. If *environment* is **undefined**, return ? *PutValue*(*lhs*, *A*).
    - ii. Return ? *InitializeReferencedBinding*(*lhs*, *A*).
  - c. Let *nextValue* be *Completion*(*IteratorValue*(*next*)).
  - d. If *nextValue* is an abrupt completion, set *iteratorRecord*.[[Done]] to **true**.
  - e. *ReturnIfAbrupt*(*nextValue*).
  - f. Perform ! *CreateDataPropertyOrThrow*(*A*, ! *ToString*(*F*(*n*)), *nextValue*).
  - g. Set *n* to *n* + 1.

*BindingRestElement* : . . . *BindingPattern*

1. Let *A* be ! *ArrayCreate*(0).
2. Let *n* be 0.
3. Repeat,
  - a. If *iteratorRecord*.[[Done]] is **false**, then
    - i. Let *next* be *Completion*(*IteratorStep*(*iteratorRecord*)).
    - ii. If *next* is an abrupt completion, set *iteratorRecord*.[[Done]] to **true**.
    - iii. *ReturnIfAbrupt*(*next*).
    - iv. If *next* is **false**, set *iteratorRecord*.[[Done]] to **true**.
  - b. If *iteratorRecord*.[[Done]] is **true**, then
    - i. Return ? *BindingInitialization* of *BindingPattern* with arguments *A* and *environment*.
  - c. Let *nextValue* be *Completion*(*IteratorValue*(*next*)).
  - d. If *nextValue* is an abrupt completion, set *iteratorRecord*.[[Done]] to **true**.
  - e. *ReturnIfAbrupt*(*nextValue*).
  - f. Perform ! *CreateDataPropertyOrThrow*(*A*, ! *ToString*(*F*(*n*)), *nextValue*).
  - g. Set *n* to *n* + 1.

*FormalParameters* : [empty]

1. Return unused.

*FormalParameters* : *FormalParameterList* , *FunctionRestParameter*

1. Perform ? *IteratorBindingInitialization* of *FormalParameterList* with arguments *iteratorRecord* and *environment*.
2. Return ? *IteratorBindingInitialization* of *FunctionRestParameter* with arguments *iteratorRecord* and *environment*.

*FormalParameterList* : *FormalParameterList* , *FormalParameter*

1. Perform ? [IteratorBindingInitialization](#) of *FormalParameterList* with arguments *iteratorRecord* and *environment*.
2. Return ? [IteratorBindingInitialization](#) of *FormalParameter* with arguments *iteratorRecord* and *environment*.

*ArrowParameters* : *BindingIdentifier*

1. Let *v* be **undefined**.
2. **Assert**: *iteratorRecord*.[[Done]] is **false**.
3. Let *next* be [Completion](#)([IteratorStep](#)(*iteratorRecord*)).
4. If *next* is an **abrupt completion**, set *iteratorRecord*.[[Done]] to **true**.
5. [ReturnIfAbrupt](#)(*next*).
6. If *next* is **false**, set *iteratorRecord*.[[Done]] to **true**.
7. Else,
  - a. Set *v* to [Completion](#)([IteratorValue](#)(*next*)).
  - b. If *v* is an **abrupt completion**, set *iteratorRecord*.[[Done]] to **true**.
  - c. [ReturnIfAbrupt](#)(*v*).
8. Return ? [BindingInitialization](#) of *BindingIdentifier* with arguments *v* and *environment*.

*ArrowParameters* : *CoverParenthesizedExpressionAndArrowParameterList*

1. Let *formals* be the *ArrowFormalParameters* that is **covered** by *CoverParenthesizedExpressionAndArrowParameterList*.
2. Return ? [IteratorBindingInitialization](#) of *formals* with arguments *iteratorRecord* and *environment*.

*AsyncArrowBindingIdentifier* : *BindingIdentifier*

1. Let *v* be **undefined**.
2. **Assert**: *iteratorRecord*.[[Done]] is **false**.
3. Let *next* be [Completion](#)([IteratorStep](#)(*iteratorRecord*)).
4. If *next* is an **abrupt completion**, set *iteratorRecord*.[[Done]] to **true**.
5. [ReturnIfAbrupt](#)(*next*).
6. If *next* is **false**, set *iteratorRecord*.[[Done]] to **true**.
7. Else,
  - a. Set *v* to [Completion](#)([IteratorValue](#)(*next*)).
  - b. If *v* is an **abrupt completion**, set *iteratorRecord*.[[Done]] to **true**.
  - c. [ReturnIfAbrupt](#)(*v*).
8. Return ? [BindingInitialization](#) of *BindingIdentifier* with arguments *v* and *environment*.

## 8.6.4 Static Semantics: AssignmentTargetType

The [syntax-directed operation](#) *AssignmentTargetType* takes no arguments and returns simple or invalid. It is defined piecewise over the following productions:

*IdentifierReference* : *Identifier*

1. If this *IdentifierReference* is contained in **strict mode code** and [StringValue](#) of *Identifier* is either **"eval"** or **"arguments"**, return invalid.
2. Return simple.

*IdentifierReference* :

**yield**  
**await**

*CallExpression* :

*CallExpression* [ *Expression* ]  
*CallExpression* . *IdentifierName*  
*CallExpression* . *PrivateIdentifier*

*MemberExpression* :

*MemberExpression* [ *Expression* ]  
*MemberExpression* . *IdentifierName*  
*SuperProperty*  
*MemberExpression* . *PrivateIdentifier*

1. Return simple.

*PrimaryExpression* :

*CoverParenthesizedExpressionAndArrowParameterList*

1. Let *expr* be the *ParenthesizedExpression* that is covered by *CoverParenthesizedExpressionAndArrowParameterList*.
2. Return *AssignmentTargetType* of *expr*.

*PrimaryExpression* :

**this**  
*Literal*  
*ArrayLiteral*  
*ObjectLiteral*  
*FunctionExpression*  
*ClassExpression*  
*GeneratorExpression*  
*AsyncFunctionExpression*  
*AsyncGeneratorExpression*  
*RegularExpressionLiteral*  
*TemplateLiteral*

*CallExpression* :

*CoverCallExpressionAndAsyncArrowHead*  
*SuperCall*  
*ImportCall*  
*CallExpression Arguments*  
*CallExpression TemplateLiteral*

*NewExpression* :

**new** *NewExpression*

*MemberExpression* :

*MemberExpression TemplateLiteral*  
**new** *MemberExpression Arguments*

*NewTarget* :

**new** . **target**

*ImportMeta* :

**import** . **meta**

*LeftHandSideExpression* :

*OptionalExpression*

*UpdateExpression* :

*LeftHandSideExpression* ++  
*LeftHandSideExpression* --  
++ *UnaryExpression*  
-- *UnaryExpression*

*UnaryExpression* :

**delete** *UnaryExpression*  
**void** *UnaryExpression*  
**typeof** *UnaryExpression*  
+ *UnaryExpression*

- *UnaryExpression*
- *UnaryExpression*
- ! *UnaryExpression*
- AwaitExpression*
- ExponentiationExpression* :
  - UpdateExpression* \*\* *ExponentiationExpression*
- MultiplicativeExpression* :
  - MultiplicativeExpression* *MultiplicativeOperator* *ExponentiationExpression*
- AdditiveExpression* :
  - AdditiveExpression* + *MultiplicativeExpression*
  - AdditiveExpression* - *MultiplicativeExpression*
- ShiftExpression* :
  - ShiftExpression* << *AdditiveExpression*
  - ShiftExpression* >> *AdditiveExpression*
  - ShiftExpression* >>> *AdditiveExpression*
- RelationalExpression* :
  - RelationalExpression* < *ShiftExpression*
  - RelationalExpression* > *ShiftExpression*
  - RelationalExpression* <= *ShiftExpression*
  - RelationalExpression* >= *ShiftExpression*
  - RelationalExpression* **instanceof** *ShiftExpression*
  - RelationalExpression* **in** *ShiftExpression*
  - PrivateIdentifier* **in** *ShiftExpression*
- EqualityExpression* :
  - EqualityExpression* == *RelationalExpression*
  - EqualityExpression* != *RelationalExpression*
  - EqualityExpression* === *RelationalExpression*
  - EqualityExpression* !== *RelationalExpression*
- BitwiseANDExpression* :
  - BitwiseANDExpression* & *EqualityExpression*
- BitwiseXORExpression* :
  - BitwiseXORExpression* ^ *BitwiseANDExpression*
- BitwiseORExpression* :
  - BitwiseORExpression* | *BitwiseXORExpression*
- LogicalANDExpression* :
  - LogicalANDExpression* && *BitwiseORExpression*
- LogicalORExpression* :
  - LogicalORExpression* || *LogicalANDExpression*
- CoalesceExpression* :
  - CoalesceExpressionHead* ?? *BitwiseORExpression*
- ConditionalExpression* :
  - ShortCircuitExpression* ? *AssignmentExpression* : *AssignmentExpression*
- AssignmentExpression* :
  - YieldExpression*
  - ArrowFunction*
  - AsyncArrowFunction*
  - LeftHandSideExpression* = *AssignmentExpression*
  - LeftHandSideExpression* *AssignmentOperator* *AssignmentExpression*
  - LeftHandSideExpression* &&= *AssignmentExpression*
  - LeftHandSideExpression* ||= *AssignmentExpression*
  - LeftHandSideExpression* ??= *AssignmentExpression*
- Expression* :
  - Expression* , *AssignmentExpression*

1. Return invalid.

## 8.6.5 Static Semantics: PropName

The [syntax-directed operation](#) PropName takes no arguments and returns a String or empty. It is defined piecewise over the following productions:

*PropertyDefinition* : *IdentifierReference*

1. Return [StringValue](#) of *IdentifierReference*.

*PropertyDefinition* : ... *AssignmentExpression*

1. Return empty.

*PropertyDefinition* : *PropertyName* : *AssignmentExpression*

1. Return [PropName](#) of *PropertyName*.

*LiteralPropertyName* : *IdentifierName*

1. Return [StringValue](#) of *IdentifierName*.

*LiteralPropertyName* : *StringLiteral*

1. Return the [SV](#) of *StringLiteral*.

*LiteralPropertyName* : *NumericLiteral*

1. Let *nbr* be the [NumericValue](#) of *NumericLiteral*.
2. Return ! [ToString](#)(*nbr*).

*ComputedPropertyName* : [ *AssignmentExpression* ]

1. Return empty.

*MethodDefinition* :

```
ClassElementName ( UniqueFormalParameters ) { FunctionBody }  
get ClassElementName ( ) { FunctionBody }  
set ClassElementName ( PropertySetParameterList ) { FunctionBody }
```

1. Return [PropName](#) of *ClassElementName*.

*GeneratorMethod* : \* *ClassElementName* ( *UniqueFormalParameters* ) { *GeneratorBody* }

1. Return [PropName](#) of *ClassElementName*.

*AsyncGeneratorMethod* : **async** \* *ClassElementName* ( *UniqueFormalParameters* ) { *AsyncGeneratorBody* }

1. Return [PropName](#) of *ClassElementName*.

*ClassElement* : *ClassStaticBlock*

1. Return empty.

*ClassElement* : ;

1. Return empty.

*AsyncMethod* : **async** *ClassElementName* ( *UniqueFormalParameters* ) { *AsyncFunctionBody* }

1. Return [PropName](#) of *ClassElementName*.



*FieldDefinition* : *ClassElementName* *Initializer*<sub>opt</sub>

1. Return *PropName* of *ClassElementName*.

*ClassElementName* : *PrivateIdentifier*

1. Return empty.

## 9 Executable Code and Execution Contexts

### 9.1 Environment Records

*Environment Record* is a specification type used to define the association of *Identifiers* to specific variables and functions, based upon the lexical nesting structure of ECMAScript code. Usually an *Environment Record* is associated with some specific syntactic structure of ECMAScript code such as a *FunctionDeclaration*, a *BlockStatement*, or a *Catch* clause of a *TryStatement*. Each time such code is evaluated, a new *Environment Record* is created to record the identifier bindings that are created by that code.

Every *Environment Record* has an `[[OuterEnv]]` field, which is either **null** or a reference to an outer *Environment Record*. This is used to model the logical nesting of *Environment Record* values. The outer reference of an (inner) *Environment Record* is a reference to the *Environment Record* that logically surrounds the inner *Environment Record*. An outer *Environment Record* may, of course, have its own outer *Environment Record*. An *Environment Record* may serve as the outer environment for multiple inner *Environment Records*. For example, if a *FunctionDeclaration* contains two nested *FunctionDeclarations* then the *Environment Records* of each of the nested functions will have as their outer *Environment Record* the *Environment Record* of the current evaluation of the surrounding function.

*Environment Records* are purely specification mechanisms and need not correspond to any specific artefact of an ECMAScript implementation. It is impossible for an ECMAScript program to directly access or manipulate such values.

#### 9.1.1 The Environment Record Type Hierarchy

*Environment Records* can be thought of as existing in a simple object-oriented hierarchy where *Environment Record* is an abstract class with three concrete subclasses: *Declarative Environment Record*, *Object Environment Record*, and *Global Environment Record*. *Function Environment Records* and *Module Environment Records* are subclasses of *Declarative Environment Record*.

- *Environment Record* (abstract)
  - A *Declarative Environment Record* is used to define the effect of ECMAScript language syntactic elements such as *FunctionDeclarations*, *VariableDeclarations*, and *Catch* clauses that directly associate identifier bindings with *ECMAScript language values*.
    - A *Function Environment Record* corresponds to the invocation of an ECMAScript *function object*, and contains bindings for the top-level declarations within that function. It may establish a new **this** binding. It also captures the state necessary to support **super** method invocations.
    - A *Module Environment Record* contains the bindings for the top-level declarations of a *Module*. It also contains the bindings that are explicitly imported by the *Module*. Its `[[OuterEnv]]` is a *Global Environment Record*.
  - An *Object Environment Record* is used to define the effect of ECMAScript elements such as *WithStatement* that associate identifier bindings with the properties of some object.

- A *Global Environment Record* is used for *Script* global declarations. It does not have an outer environment; its `[[OuterEnv]]` is `null`. It may be prepopulated with identifier bindings and it includes an associated *global object* whose properties provide some of the global environment's identifier bindings. As ECMAScript code is executed, additional properties may be added to the *global object* and the initial properties may be modified.

The *Environment Record* abstract class includes the abstract specification methods defined in Table 16. These abstract methods have distinct concrete algorithms for each of the concrete subclasses.

**Table 16: Abstract Methods of Environment Records**

Method	Purpose
HasBinding(N)	Determine if an <i>Environment Record</i> has a binding for the String value <i>N</i> . Return <b>true</b> if it does and <b>false</b> if it does not.
CreateMutableBinding(N, D)	Create a new but uninitialized mutable binding in an <i>Environment Record</i> . The String value <i>N</i> is the text of the bound name. If the Boolean argument <i>D</i> is <b>true</b> the binding may be subsequently deleted.
CreateImmutableBinding(N, S)	Create a new but uninitialized immutable binding in an <i>Environment Record</i> . The String value <i>N</i> is the text of the bound name. If <i>S</i> is <b>true</b> then attempts to set it after it has been initialized will always throw an exception, regardless of the strict mode setting of operations that reference that binding.
InitializeBinding(N, V)	Set the value of an already existing but uninitialized binding in an <i>Environment Record</i> . The String value <i>N</i> is the text of the bound name. <i>V</i> is the value for the binding and is a value of any <i>ECMAScript language type</i> .
SetMutableBinding(N, V, S)	Set the value of an already existing mutable binding in an <i>Environment Record</i> . The String value <i>N</i> is the text of the bound name. <i>V</i> is the value for the binding and may be a value of any <i>ECMAScript language type</i> . <i>S</i> is a Boolean flag. If <i>S</i> is <b>true</b> and the binding cannot be set throw a <b>TypeError</b> exception.
GetBindingValue(N, S)	Returns the value of an already existing binding from an <i>Environment Record</i> . The String value <i>N</i> is the text of the bound name. <i>S</i> is used to identify references originating in <i>strict mode code</i> or that otherwise require strict mode reference semantics. If <i>S</i> is <b>true</b> and the binding does not exist throw a <b>ReferenceError</b> exception. If the binding exists but is uninitialized a <b>ReferenceError</b> is thrown, regardless of the value of <i>S</i> .
DeleteBinding(N)	Delete a binding from an <i>Environment Record</i> . The String value <i>N</i> is the text of the bound name. If a binding for <i>N</i> exists, remove the binding and return <b>true</b> . If the binding exists but cannot be removed return <b>false</b> . If the binding does not exist return <b>true</b> .
HasThisBinding()	Determine if an <i>Environment Record</i> establishes a <b>this</b> binding. Return <b>true</b> if it does and <b>false</b> if it does not.
HasSuperBinding()	Determine if an <i>Environment Record</i> establishes a <b>super</b> method binding. Return <b>true</b> if it does and <b>false</b> if it does not.
WithBaseObject()	If this <i>Environment Record</i> is associated with a <b>with</b> statement, return the with object. Otherwise, return <b>undefined</b> .

### 9.1.1.1 Declarative Environment Records

Each *Declarative Environment Record* is associated with an ECMAScript program scope containing variable, constant, let, class, module, import, and/or function declarations. A Declarative Environment Record binds the set of identifiers defined by the declarations contained within its scope.

The behaviour of the concrete specification methods for Declarative Environment Records is defined by the following algorithms.

#### 9.1.1.1.1 HasBinding ( *N* )

The HasBinding concrete method of a Declarative Environment Record *envRec* takes argument *N* (a String) and returns a normal completion containing a Boolean. It determines if the argument identifier is one of the identifiers bound by the record. It performs the following steps when called:

1. If *envRec* has a binding for *N*, return **true**.
2. Return **false**.

#### 9.1.1.1.2 CreateMutableBinding ( *N*, *D* )

The CreateMutableBinding concrete method of a Declarative Environment Record *envRec* takes arguments *N* (a String) and *D* (a Boolean) and returns a normal completion containing unused. It creates a new mutable binding for the name *N* that is uninitialized. A binding must not already exist in this Environment Record for *N*. If *D* is **true**, the new binding is marked as being subject to deletion. It performs the following steps when called:

1. **Assert**: *envRec* does not already have a binding for *N*.
2. Create a mutable binding in *envRec* for *N* and record that it is uninitialized. If *D* is **true**, record that the newly created binding may be deleted by a subsequent DeleteBinding call.
3. Return unused.

#### 9.1.1.1.3 CreateImmutableBinding ( *N*, *S* )

The CreateImmutableBinding concrete method of a Declarative Environment Record *envRec* takes arguments *N* (a String) and *S* (a Boolean) and returns a normal completion containing unused. It creates a new immutable binding for the name *N* that is uninitialized. A binding must not already exist in this Environment Record for *N*. If *S* is **true**, the new binding is marked as a strict binding. It performs the following steps when called:

1. **Assert**: *envRec* does not already have a binding for *N*.
2. Create an immutable binding in *envRec* for *N* and record that it is uninitialized. If *S* is **true**, record that the newly created binding is a strict binding.
3. Return unused.

#### 9.1.1.1.4 InitializeBinding ( *N*, *V* )

The InitializeBinding concrete method of a Declarative Environment Record *envRec* takes arguments *N* (a String) and *V* (an ECMAScript language value) and returns a normal completion containing unused. It is used to set the bound value of the current binding of the identifier whose name is *N* to the value *V*. An uninitialized binding for *N* must already exist. It performs the following steps when called:

1. **Assert**: *envRec* must have an uninitialized binding for *N*.
2. Set the bound value for *N* in *envRec* to *V*.
3. Record that the binding for *N* in *envRec* has been initialized.
4. Return unused.

#### 9.1.1.1.5 SetMutableBinding ( *N*, *V*, *S* )

The SetMutableBinding concrete method of a Declarative Environment Record *envRec* takes arguments *N* (a String), *V* (an ECMAScript language value), and *S* (a Boolean) and returns either a normal completion

containing unused or a [throw completion](#). It attempts to change the bound value of the current binding of the identifier whose name is *N* to the value *V*. A binding for *N* normally already exists, but in rare cases it may not. If the binding is an immutable binding, a **TypeError** is thrown if *S* is **true**. It performs the following steps when called:

1. If *envRec* does not have a binding for *N*, then
  - a. If *S* is **true**, throw a **ReferenceError** exception.
  - b. Perform ! *envRec*.CreateMutableBinding(*N*, **true**).
  - c. Perform ! *envRec*.InitializeBinding(*N*, *V*).
  - d. Return unused.
2. If the binding for *N* in *envRec* is a strict binding, set *S* to **true**.
3. If the binding for *N* in *envRec* has not yet been initialized, throw a **ReferenceError** exception.
4. Else if the binding for *N* in *envRec* is a mutable binding, change its bound value to *V*.
5. Else,
  - a. **Assert**: This is an attempt to change the value of an immutable binding.
  - b. If *S* is **true**, throw a **TypeError** exception.
6. Return unused.

**NOTE** An example of ECMAScript code that results in a missing binding at step 1 is:

```
function f() { eval("var x; x = (delete x, 0);"); }
```

#### 9.1.1.1.6 GetBindingValue ( *N*, *S* )

The GetBindingValue concrete method of a [Declarative Environment Record](#) *envRec* takes arguments *N* (a String) and *S* (a Boolean) and returns either a [normal completion containing an ECMAScript language value](#) or a [throw completion](#). It returns the value of its bound identifier whose name is *N*. If the binding exists but is uninitialized a **ReferenceError** is thrown, regardless of the value of *S*. It performs the following steps when called:

1. **Assert**: *envRec* has a binding for *N*.
2. If the binding for *N* in *envRec* is an uninitialized binding, throw a **ReferenceError** exception.
3. Return the value currently bound to *N* in *envRec*.

#### 9.1.1.1.7 DeleteBinding ( *N* )

The DeleteBinding concrete method of a [Declarative Environment Record](#) *envRec* takes argument *N* (a String) and returns a [normal completion containing](#) a Boolean. It can only delete bindings that have been explicitly designated as being subject to deletion. It performs the following steps when called:

1. **Assert**: *envRec* has a binding for *N*.
2. If the binding for *N* in *envRec* cannot be deleted, return **false**.
3. Remove the binding for *N* from *envRec*.
4. Return **true**.

#### 9.1.1.1.8 HasThisBinding ( )

The HasThisBinding concrete method of a [Declarative Environment Record](#) *envRec* takes no arguments and returns **false**. It performs the following steps when called:

1. Return **false**.

NOTE A regular [Declarative Environment Record](#) (i.e., one that is neither a [Function Environment Record](#) nor a [Module Environment Record](#)) does not provide a **this** binding.

#### 9.1.1.1.9 HasSuperBinding ( )

The HasSuperBinding concrete method of a [Declarative Environment Record](#) *envRec* takes no arguments and returns **false**. It performs the following steps when called:

1. Return **false**.

NOTE A regular [Declarative Environment Record](#) (i.e., one that is neither a [Function Environment Record](#) nor a [Module Environment Record](#)) does not provide a **super** binding.

#### 9.1.1.1.10 WithBaseObject ( )

The WithBaseObject concrete method of a [Declarative Environment Record](#) *envRec* takes no arguments and returns **undefined**. It performs the following steps when called:

1. Return **undefined**.

### 9.1.1.2 Object Environment Records

Each *Object Environment Record* is associated with an object called its *binding object*. An Object Environment Record binds the set of string identifier names that directly correspond to the property names of its binding object. [Property keys](#) that are not strings in the form of an *IdentifierName* are not included in the set of bound identifiers. Both own and inherited properties are included in the set regardless of the setting of their `[[Enumerable]]` attribute. Because properties can be dynamically added and deleted from objects, the set of identifiers bound by an Object Environment Record may potentially change as a side-effect of any operation that adds or deletes properties. Any bindings that are created as a result of such a side-effect are considered to be a mutable binding even if the `Writable` attribute of the corresponding property is **false**. Immutable bindings do not exist for Object Environment Records.

Object Environment Records created for **with** statements (14.11) can provide their binding object as an implicit **this** value for use in function calls. The capability is controlled by a Boolean `[[IsWithEnvironment]]` field.

Object Environment Records have the additional state fields listed in [Table 17](#).

Table 17: Additional Fields of [Object Environment Records](#)

Field Name	Value	Meaning
<code>[[BindingObject]]</code>	an Object	The binding object of this <a href="#">Environment Record</a> .
<code>[[IsWithEnvironment]]</code>	a Boolean	Indicates whether this <a href="#">Environment Record</a> is created for a <b>with</b> statement.

The behaviour of the concrete specification methods for Object Environment Records is defined by the following algorithms.

### 9.1.1.2.1 HasBinding ( *N* )

The HasBinding concrete method of an [Object Environment Record](#) *envRec* takes argument *N* (a String) and returns either a [normal completion containing](#) a Boolean or a [throw completion](#). It determines if its associated binding object has a property whose name is *N*. It performs the following steps when called:

1. Let *bindingObject* be *envRec*.[[BindingObject]].
2. Let *foundBinding* be ? [HasProperty](#)(*bindingObject*, *N*).
3. If *foundBinding* is **false**, return **false**.
4. If *envRec*.[[IsWithEnvironment]] is **false**, return **true**.
5. Let *unscopables* be ? [Get](#)(*bindingObject*, @@unscopables).
6. If *unscopables* is an Object, then
  - a. Let *blocked* be [ToBoolean](#)(? [Get](#)(*unscopables*, *N*)).
  - b. If *blocked* is **true**, return **false**.
7. Return **true**.

### 9.1.1.2.2 CreateMutableBinding ( *N*, *D* )

The CreateMutableBinding concrete method of an [Object Environment Record](#) *envRec* takes arguments *N* (a String) and *D* (a Boolean) and returns either a [normal completion containing](#) unused or a [throw completion](#). It creates in an [Environment Record](#)'s associated binding object a property whose name is *N* and initializes it to the value **undefined**. If *D* is **true**, the new property's [[Configurable]] attribute is set to **true**; otherwise it is set to **false**. It performs the following steps when called:

1. Let *bindingObject* be *envRec*.[[BindingObject]].
2. Perform ? [DefinePropertyOrThrow](#)(*bindingObject*, *N*, PropertyDescriptor { [[Value]]: **undefined**, [[Writable]]: **true**, [[Enumerable]]: **true**, [[Configurable]]: *D* }).
3. Return unused.

**NOTE** Normally *envRec* will not have a binding for *N* but if it does, the semantics of [DefinePropertyOrThrow](#) may result in an existing binding being replaced or shadowed or cause an [abrupt completion](#) to be returned.

### 9.1.1.2.3 CreateImmutableBinding ( *N*, *S* )

The CreateImmutableBinding concrete method of an [Object Environment Record](#) is never used within this specification.

### 9.1.1.2.4 InitializeBinding ( *N*, *V* )

The InitializeBinding concrete method of an [Object Environment Record](#) *envRec* takes arguments *N* (a String) and *V* (an [ECMAScript language value](#)) and returns either a [normal completion containing](#) unused or a [throw completion](#). It is used to set the bound value of the current binding of the identifier whose name is *N* to the value *V*. It performs the following steps when called:

1. Perform ? *envRec*.SetMutableBinding(*N*, *V*, **false**).
2. Return unused.

**NOTE** In this specification, all uses of CreateMutableBinding for [Object Environment Records](#) are immediately followed by a call to InitializeBinding for the same name. Hence, this specification does not explicitly track the initialization state of bindings in [Object Environment Records](#).

#### 9.1.1.2.5 SetMutableBinding ( *N*, *V*, *S* )

The SetMutableBinding concrete method of an [Object Environment Record](#) *envRec* takes arguments *N* (a String), *V* (an [ECMAScript language value](#)), and *S* (a Boolean) and returns either a [normal completion containing](#) unused or a [throw completion](#). It attempts to set the value of the [Environment Record's](#) associated binding object's property whose name is *N* to the value *V*. A property named *N* normally already exists but if it does not or is not currently writable, error handling is determined by *S*. It performs the following steps when called:

1. Let *bindingObject* be *envRec*.[[BindingObject]].
2. Let *stillExists* be ? [HasProperty](#)(*bindingObject*, *N*).
3. If *stillExists* is **false** and *S* is **true**, throw a **ReferenceError** exception.
4. Perform ? [Set](#)(*bindingObject*, *N*, *V*, *S*).
5. Return unused.

#### 9.1.1.2.6 GetBindingValue ( *N*, *S* )

The GetBindingValue concrete method of an [Object Environment Record](#) *envRec* takes arguments *N* (a String) and *S* (a Boolean) and returns either a [normal completion containing](#) an [ECMAScript language value](#) or a [throw completion](#). It returns the value of its associated binding object's property whose name is *N*. The property should already exist but if it does not the result depends upon *S*. It performs the following steps when called:

1. Let *bindingObject* be *envRec*.[[BindingObject]].
2. Let *value* be ? [HasProperty](#)(*bindingObject*, *N*).
3. If *value* is **false**, then
  - a. If *S* is **false**, return **undefined**; otherwise throw a **ReferenceError** exception.
4. Return ? [Get](#)(*bindingObject*, *N*).

#### 9.1.1.2.7 DeleteBinding ( *N* )

The DeleteBinding concrete method of an [Object Environment Record](#) *envRec* takes argument *N* (a String) and returns either a [normal completion containing](#) a Boolean or a [throw completion](#). It can only delete bindings that correspond to properties of the environment object whose [[Configurable]] attribute have the value **true**. It performs the following steps when called:

1. Let *bindingObject* be *envRec*.[[BindingObject]].
2. Return ? *bindingObject*.[[Delete]](*N*).

#### 9.1.1.2.8 HasThisBinding ( )

The HasThisBinding concrete method of an [Object Environment Record](#) *envRec* takes no arguments and returns **false**. It performs the following steps when called:

1. Return **false**.

**NOTE** [Object Environment Records](#) do not provide a **this** binding.

#### 9.1.1.2.9 HasSuperBinding ( )

The HasSuperBinding concrete method of an [Object Environment Record](#) *envRec* takes no arguments and returns **false**. It performs the following steps when called:

1. Return **false**.

**NOTE** [Object Environment Records](#) do not provide a **super** binding.

### 9.1.1.2.10 WithBaseObject ( )

The WithBaseObject concrete method of an [Object Environment Record](#) *envRec* takes no arguments and returns an Object or **undefined**. It performs the following steps when called:

1. If *envRec*.[[IsWithEnvironment]] is **true**, return *envRec*.[[BindingObject]].
2. Otherwise, return **undefined**.

### 9.1.1.3 Function Environment Records

A *Function Environment Record* is a [Declarative Environment Record](#) that is used to represent the top-level scope of a function and, if the function is not an *ArrowFunction*, provides a **this** binding. If a function is not an *ArrowFunction* function and references **super**, its Function Environment Record also contains the state that is used to perform **super** method invocations from within the function.

Function Environment Records have the additional state fields listed in [Table 18](#).

**Table 18: Additional Fields of Function Environment Records**

Field Name	Value	Meaning
[[ThisValue]]	an <a href="#">ECMAScript language value</a>	This is the <b>this</b> value used for this invocation of the function.
[[ThisBindingStatus]]	lexical, initialized, or uninitialized	If the value is lexical, this is an <i>ArrowFunction</i> and does not have a local <b>this</b> value.
[[FunctionObject]]	an <a href="#">ECMAScript function object</a>	The <a href="#">function object</a> whose invocation caused this <a href="#">Environment Record</a> to be created.
[[NewTarget]]	an Object or <b>undefined</b>	If this <a href="#">Environment Record</a> was created by the [[Construct]] internal method, [[NewTarget]] is the value of the [[Construct]] <i>newTarget</i> parameter. Otherwise, its value is <b>undefined</b> .

Function Environment Records support all of the [Declarative Environment Record](#) methods listed in [Table 16](#) and share the same specifications for all of those methods except for HasThisBinding and HasSuperBinding. In addition, Function Environment Records support the methods listed in [Table 19](#):

**Table 19: Additional Methods of Function Environment Records**

Method	Purpose
BindThisValue(V)	Set the [[ThisValue]] and record that it has been initialized.
GetThisBinding()	Return the value of this <a href="#">Environment Record</a> 's <b>this</b> binding. Throws a <b>ReferenceError</b> if the <b>this</b> binding has not been initialized.
GetSuperBase()	Return the object that is the base for <b>super</b> property accesses bound in this <a href="#">Environment Record</a> . The value <b>undefined</b> indicates that such accesses will produce runtime errors.



The behaviour of the additional concrete specification methods for Function Environment Records is defined by the following algorithms:

#### 9.1.1.3.1 BindThisValue ( *V* )

The BindThisValue concrete method of a [Function Environment Record](#) *envRec* takes argument *V* (an [ECMAScript language value](#)) and returns either a [normal completion containing an ECMAScript language value](#) or a [throw completion](#). It performs the following steps when called:

1. **Assert:** *envRec*.[[ThisBindingStatus]] is not lexical.
2. If *envRec*.[[ThisBindingStatus]] is initialized, throw a **ReferenceError** exception.
3. Set *envRec*.[[ThisValue]] to *V*.
4. Set *envRec*.[[ThisBindingStatus]] to initialized.
5. Return *V*.

#### 9.1.1.3.2 HasThisBinding ( )

The HasThisBinding concrete method of a [Function Environment Record](#) *envRec* takes no arguments and returns a Boolean. It performs the following steps when called:

1. If *envRec*.[[ThisBindingStatus]] is lexical, return **false**; otherwise, return **true**.

#### 9.1.1.3.3 HasSuperBinding ( )

The HasSuperBinding concrete method of a [Function Environment Record](#) *envRec* takes no arguments and returns a Boolean. It performs the following steps when called:

1. If *envRec*.[[ThisBindingStatus]] is lexical, return **false**.
2. If *envRec*.[[FunctionObject]].[[HomeObject]] is **undefined**, return **false**; otherwise, return **true**.

#### 9.1.1.3.4 GetThisBinding ( )

The GetThisBinding concrete method of a [Function Environment Record](#) *envRec* takes no arguments and returns either a [normal completion containing an ECMAScript language value](#) or a [throw completion](#). It performs the following steps when called:

1. **Assert:** *envRec*.[[ThisBindingStatus]] is not lexical.
2. If *envRec*.[[ThisBindingStatus]] is uninitialized, throw a **ReferenceError** exception.
3. Return *envRec*.[[ThisValue]].

#### 9.1.1.3.5 GetSuperBase ( )

The GetSuperBase concrete method of a [Function Environment Record](#) *envRec* takes no arguments and returns either a [normal completion containing](#) either an Object, **null**, or **undefined**, or a [throw completion](#). It performs the following steps when called:

1. Let *home* be *envRec*.[[FunctionObject]].[[HomeObject]].
2. If *home* is **undefined**, return **undefined**.
3. **Assert:** *home* is an Object.
4. Return ? *home*.[[GetPrototypeOf]]().

### 9.1.1.4 Global Environment Records

A *Global Environment Record* is used to represent the outer most scope that is shared by all of the ECMAScript *Script* elements that are processed in a common *realm*. A Global Environment Record provides the bindings for built-in globals (clause 19), properties of the *global object*, and for all top-level declarations (8.2.9, 8.2.11) that occur within a *Script*.

A Global Environment Record is logically a single record but it is specified as a composite encapsulating an *Object Environment Record* and a *Declarative Environment Record*. The *Object Environment Record* has as its base object the *global object* of the associated *Realm Record*. This *global object* is the value returned by the Global Environment Record's *GetThisBinding* concrete method. The *Object Environment Record* component of a Global Environment Record contains the bindings for all built-in globals (clause 19) and all bindings introduced by a *FunctionDeclaration*, *GeneratorDeclaration*, *AsyncFunctionDeclaration*, *AsyncGeneratorDeclaration*, or *VariableStatement* contained in global code. The bindings for all other ECMAScript declarations in global code are contained in the *Declarative Environment Record* component of the Global Environment Record.

Properties may be created directly on a *global object*. Hence, the *Object Environment Record* component of a Global Environment Record may contain both bindings created explicitly by *FunctionDeclaration*, *GeneratorDeclaration*, *AsyncFunctionDeclaration*, *AsyncGeneratorDeclaration*, or *VariableDeclaration* declarations and bindings created implicitly as properties of the *global object*. In order to identify which bindings were explicitly created using declarations, a Global Environment Record maintains a list of the names bound using its *CreateGlobalVarBinding* and *CreateGlobalFunctionBinding* concrete methods.

Global Environment Records have the additional fields listed in Table 20 and the additional methods listed in Table 21.

Table 20: Additional Fields of *Global Environment Records*

Field Name	Value	Meaning
[[ObjectRecord]]	an <i>Object Environment Record</i>	Binding object is the <i>global object</i> . It contains global built-in bindings as well as <i>FunctionDeclaration</i> , <i>GeneratorDeclaration</i> , <i>AsyncFunctionDeclaration</i> , <i>AsyncGeneratorDeclaration</i> , and <i>VariableDeclaration</i> bindings in global code for the associated <i>realm</i> .
[[GlobalThisValue]]	an Object	The value returned by <b>this</b> in global scope. <i>Hosts</i> may provide any ECMAScript Object value.
[[DeclarativeRecord]]	a <i>Declarative Environment Record</i>	Contains bindings for all declarations in global code for the associated <i>realm</i> code except for <i>FunctionDeclaration</i> , <i>GeneratorDeclaration</i> , <i>AsyncFunctionDeclaration</i> , <i>AsyncGeneratorDeclaration</i> , and <i>VariableDeclaration</i> bindings.
[[VarNames]]	a <i>List</i> of Strings	The string names bound by <i>FunctionDeclaration</i> , <i>GeneratorDeclaration</i> , <i>AsyncFunctionDeclaration</i> , <i>AsyncGeneratorDeclaration</i> , and <i>VariableDeclaration</i> declarations in global code for the associated <i>realm</i> .

Table 21: Additional Methods of **Global Environment Records**

Method	Purpose
GetThisBinding()	Return the value of this <b>Environment Record's</b> <b>this</b> binding.
HasVarDeclaration (N)	Determines if the argument identifier has a binding in this <b>Environment Record</b> that was created using a <i>VariableDeclaration</i> , <i>FunctionDeclaration</i> , <i>GeneratorDeclaration</i> , <i>AsyncFunctionDeclaration</i> , or <i>AsyncGeneratorDeclaration</i> .
HasLexicalDeclaration (N)	Determines if the argument identifier has a binding in this <b>Environment Record</b> that was created using a lexical declaration such as a <i>LexicalDeclaration</i> or a <i>ClassDeclaration</i> .
HasRestrictedGlobalProperty (N)	Determines if the argument is the name of a <b>global object</b> property that may not be shadowed by a global lexical binding.
CanDeclareGlobalVar (N)	Determines if a corresponding CreateGlobalVarBinding call would succeed if called for the same argument <i>N</i> .
CanDeclareGlobalFunction (N)	Determines if a corresponding CreateGlobalFunctionBinding call would succeed if called for the same argument <i>N</i> .
CreateGlobalVarBinding(N, D)	Used to create and initialize to <b>undefined</b> a global <b>var</b> binding in the [[ObjectRecord]] component of a <b>Global Environment Record</b> . The binding will be a mutable binding. The corresponding <b>global object</b> property will have attribute values appropriate for a <b>var</b> . The String value <i>N</i> is the bound name. If <i>D</i> is <b>true</b> , the binding may be deleted. Logically equivalent to CreateMutableBinding followed by a SetMutableBinding but it allows var declarations to receive special treatment.
CreateGlobalFunctionBinding(N, V, D)	Create and initialize a global <b>function</b> binding in the [[ObjectRecord]] component of a <b>Global Environment Record</b> . The binding will be a mutable binding. The corresponding <b>global object</b> property will have attribute values appropriate for a <b>function</b> . The String value <i>N</i> is the bound name. <i>V</i> is the initialization value. If the Boolean argument <i>D</i> is <b>true</b> , the binding may be deleted. Logically equivalent to CreateMutableBinding followed by a SetMutableBinding but it allows function declarations to receive special treatment.

The behaviour of the concrete specification methods for Global Environment Records is defined by the following algorithms.

#### 9.1.1.4.1 HasBinding ( *N* )

The HasBinding concrete method of a **Global Environment Record** *envRec* takes argument *N* (a String) and returns either a **normal completion containing** a Boolean or a **throw completion**. It determines if the argument identifier is one of the identifiers bound by the record. It performs the following steps when called:

1. Let *DclRec* be *envRec*.[[DeclarativeRecord]].
2. If ! *DclRec*.HasBinding(*N*) is **true**, return **true**.
3. Let *ObjRec* be *envRec*.[[ObjectRecord]].
4. Return ? *ObjRec*.HasBinding(*N*).

#### 9.1.1.4.2 CreateMutableBinding ( *N*, *D* )

The CreateMutableBinding concrete method of a **Global Environment Record** *envRec* takes arguments *N* (a String) and *D* (a Boolean) and returns either a **normal completion containing** unused or a **throw completion**. It

creates a new mutable binding for the name *N* that is uninitialized. The binding is created in the associated DeclarativeRecord. A binding for *N* must not already exist in the DeclarativeRecord. If *D* is **true**, the new binding is marked as being subject to deletion. It performs the following steps when called:

1. Let *DclRec* be *envRec*.[[DeclarativeRecord]].
2. If ! *DclRec*.HasBinding(*N*) is **true**, throw a **TypeError** exception.
3. Return ! *DclRec*.CreateMutableBinding(*N*, *D*).

#### 9.1.1.4.3 CreateImmutableBinding ( *N*, *S* )

The CreateImmutableBinding concrete method of a Global Environment Record *envRec* takes arguments *N* (a String) and *S* (a Boolean) and returns either a normal completion containing unused or a throw completion. It creates a new immutable binding for the name *N* that is uninitialized. A binding must not already exist in this Environment Record for *N*. If *S* is **true**, the new binding is marked as a strict binding. It performs the following steps when called:

1. Let *DclRec* be *envRec*.[[DeclarativeRecord]].
2. If ! *DclRec*.HasBinding(*N*) is **true**, throw a **TypeError** exception.
3. Return ! *DclRec*.CreateImmutableBinding(*N*, *S*).

#### 9.1.1.4.4 InitializeBinding ( *N*, *V* )

The InitializeBinding concrete method of a Global Environment Record *envRec* takes arguments *N* (a String) and *V* (an ECMAScript language value) and returns either a normal completion containing unused or a throw completion. It is used to set the bound value of the current binding of the identifier whose name is *N* to the value *V*. An uninitialized binding for *N* must already exist. It performs the following steps when called:

1. Let *DclRec* be *envRec*.[[DeclarativeRecord]].
2. If ! *DclRec*.HasBinding(*N*) is **true**, then
  - a. Return ! *DclRec*.InitializeBinding(*N*, *V*).
3. **Assert**: If the binding exists, it must be in the Object Environment Record.
4. Let *ObjRec* be *envRec*.[[ObjectRecord]].
5. Return ? *ObjRec*.InitializeBinding(*N*, *V*).

#### 9.1.1.4.5 SetMutableBinding ( *N*, *V*, *S* )

The SetMutableBinding concrete method of a Global Environment Record *envRec* takes arguments *N* (a String), *V* (an ECMAScript language value), and *S* (a Boolean) and returns either a normal completion containing unused or a throw completion. It attempts to change the bound value of the current binding of the identifier whose name is *N* to the value *V*. If the binding is an immutable binding and *S* is **true**, a **TypeError** is thrown. A property named *N* normally already exists but if it does not or is not currently writable, error handling is determined by *S*. It performs the following steps when called:

1. Let *DclRec* be *envRec*.[[DeclarativeRecord]].
2. If ! *DclRec*.HasBinding(*N*) is **true**, then
  - a. Return ? *DclRec*.SetMutableBinding(*N*, *V*, *S*).
3. Let *ObjRec* be *envRec*.[[ObjectRecord]].
4. Return ? *ObjRec*.SetMutableBinding(*N*, *V*, *S*).

#### 9.1.1.4.6 GetBindingValue ( *N*, *S* )

The GetBindingValue concrete method of a Global Environment Record *envRec* takes arguments *N* (a String) and *S* (a Boolean) and returns either a normal completion containing an ECMAScript language value or a throw completion. It returns the value of its bound identifier whose name is *N*. If the binding is an uninitialized binding throw a **ReferenceError** exception. A property named *N* normally already exists but if it

does not or is not currently writable, error handling is determined by *S*. It performs the following steps when called:

1. Let *DclRec* be *envRec*.[[DeclarativeRecord]].
2. If ! *DclRec*.HasBinding(*N*) is **true**, then
  - a. Return ? *DclRec*.GetBindingValue(*N*, *S*).
3. Let *ObjRec* be *envRec*.[[ObjectRecord]].
4. Return ? *ObjRec*.GetBindingValue(*N*, *S*).

#### 9.1.1.4.7 DeleteBinding ( *N* )

The DeleteBinding concrete method of a [Global Environment Record](#) *envRec* takes argument *N* (a String) and returns either a [normal completion containing](#) a Boolean or a [throw completion](#). It can only delete bindings that have been explicitly designated as being subject to deletion. It performs the following steps when called:

1. Let *DclRec* be *envRec*.[[DeclarativeRecord]].
2. If ! *DclRec*.HasBinding(*N*) is **true**, then
  - a. Return ! *DclRec*.DeleteBinding(*N*).
3. Let *ObjRec* be *envRec*.[[ObjectRecord]].
4. Let *globalObject* be *ObjRec*.[[BindingObject]].
5. Let *existingProp* be ? [HasOwnProperty](#)(*globalObject*, *N*).
6. If *existingProp* is **true**, then
  - a. Let *status* be ? *ObjRec*.DeleteBinding(*N*).
  - b. If *status* is **true** and *envRec*.[[VarNames]] contains *N*, then
    - i. Remove *N* from *envRec*.[[VarNames]].
  - c. Return *status*.
7. Return **true**.

#### 9.1.1.4.8 HasThisBinding ( )

The HasThisBinding concrete method of a [Global Environment Record](#) *envRec* takes no arguments and returns **true**. It performs the following steps when called:

1. Return **true**.

**NOTE** [Global Environment Records](#) always provide a **this** binding.

#### 9.1.1.4.9 HasSuperBinding ( )

The HasSuperBinding concrete method of a [Global Environment Record](#) *envRec* takes no arguments and returns **false**. It performs the following steps when called:

1. Return **false**.

**NOTE** [Global Environment Records](#) do not provide a **super** binding.

#### 9.1.1.4.10 WithBaseObject ( )

The WithBaseObject concrete method of a [Global Environment Record](#) *envRec* takes no arguments and returns **undefined**. It performs the following steps when called:

1. Return **undefined**.

#### 9.1.1.4.11 GetThisBinding ( )

The GetThisBinding concrete method of a [Global Environment Record](#) *envRec* takes no arguments and returns a [normal completion containing](#) an Object. It performs the following steps when called:

1. Return *envRec*.[[GlobalThisValue]].

#### 9.1.1.4.12 HasVarDeclaration ( *N* )

The HasVarDeclaration concrete method of a [Global Environment Record](#) *envRec* takes argument *N* (a String) and returns a Boolean. It determines if the argument identifier has a binding in this record that was created using a *VariableStatement* or a *FunctionDeclaration*. It performs the following steps when called:

1. Let *varDeclaredNames* be *envRec*.[[VarNames]].
2. If *varDeclaredNames* contains *N*, return **true**.
3. Return **false**.

#### 9.1.1.4.13 HasLexicalDeclaration ( *N* )

The HasLexicalDeclaration concrete method of a [Global Environment Record](#) *envRec* takes argument *N* (a String) and returns a Boolean. It determines if the argument identifier has a binding in this record that was created using a lexical declaration such as a *LexicalDeclaration* or a *ClassDeclaration*. It performs the following steps when called:

1. Let *DclRec* be *envRec*.[[DeclarativeRecord]].
2. Return ! *DclRec*.HasBinding(*N*).

#### 9.1.1.4.14 HasRestrictedGlobalProperty ( *N* )

The HasRestrictedGlobalProperty concrete method of a [Global Environment Record](#) *envRec* takes argument *N* (a String) and returns either a [normal completion containing](#) a Boolean or a [throw completion](#). It determines if the argument identifier is the name of a property of the [global object](#) that must not be shadowed by a global lexical binding. It performs the following steps when called:

1. Let *ObjRec* be *envRec*.[[ObjectRecord]].
2. Let *globalObject* be *ObjRec*.[[BindingObject]].
3. Let *existingProp* be ? *globalObject*.[[GetOwnProperty]](*N*).
4. If *existingProp* is **undefined**, return **false**.
5. If *existingProp*.[[Configurable]] is **true**, return **false**.
6. Return **true**.

**NOTE** Properties may exist upon a [global object](#) that were directly created rather than being declared using a var or function declaration. A global lexical binding may not be created that has the same name as a non-configurable property of the [global object](#). The global property **"undefined"** is an example of such a property.

#### 9.1.1.4.15 CanDeclareGlobalVar ( *N* )

The CanDeclareGlobalVar concrete method of a [Global Environment Record](#) *envRec* takes argument *N* (a String) and returns either a [normal completion containing](#) a Boolean or a [throw completion](#). It determines if a corresponding CreateGlobalVarBinding call would succeed if called for the same argument *N*. Redundant var

declarations and var declarations for pre-existing [global object](#) properties are allowed. It performs the following steps when called:

1. Let *ObjRec* be *envRec*.[[ObjectRecord]].
2. Let *globalObject* be *ObjRec*.[[BindingObject]].
3. Let *hasProperty* be ? *HasOwnProperty*(*globalObject*, *N*).
4. If *hasProperty* is **true**, return **true**.
5. Return ? *IsExtensible*(*globalObject*).

#### 9.1.1.4.16 CanDeclareGlobalFunction ( *N* )

The *CanDeclareGlobalFunction* concrete method of a [Global Environment Record](#) *envRec* takes argument *N* (a String) and returns either a [normal completion containing](#) a Boolean or a [throw completion](#). It determines if a corresponding *CreateGlobalFunctionBinding* call would succeed if called for the same argument *N*. It performs the following steps when called:

1. Let *ObjRec* be *envRec*.[[ObjectRecord]].
2. Let *globalObject* be *ObjRec*.[[BindingObject]].
3. Let *existingProp* be ? *globalObject*.[[GetOwnProperty]](*N*).
4. If *existingProp* is **undefined**, return ? *IsExtensible*(*globalObject*).
5. If *existingProp*.[[Configurable]] is **true**, return **true**.
6. If *IsDataDescriptor*(*existingProp*) is **true** and *existingProp* has attribute values { [[Writable]]: **true**, [[Enumerable]]: **true** }, return **true**.
7. Return **false**.

#### 9.1.1.4.17 CreateGlobalVarBinding ( *N*, *D* )

The *CreateGlobalVarBinding* concrete method of a [Global Environment Record](#) *envRec* takes arguments *N* (a String) and *D* (a Boolean) and returns either a [normal completion containing unused](#) or a [throw completion](#). It creates and initializes a mutable binding in the associated [Object Environment Record](#) and records the bound name in the associated [[VarNames]] [List](#). If a binding already exists, it is reused and assumed to be initialized. It performs the following steps when called:

1. Let *ObjRec* be *envRec*.[[ObjectRecord]].
2. Let *globalObject* be *ObjRec*.[[BindingObject]].
3. Let *hasProperty* be ? *HasOwnProperty*(*globalObject*, *N*).
4. Let *extensible* be ? *IsExtensible*(*globalObject*).
5. If *hasProperty* is **false** and *extensible* is **true**, then
  - a. Perform ? *ObjRec*.CreateMutableBinding(*N*, *D*).
  - b. Perform ? *ObjRec*.InitializeBinding(*N*, **undefined**).
6. If *envRec*.[[VarNames]] does not contain *N*, then
  - a. Append *N* to *envRec*.[[VarNames]].
7. Return unused.

#### 9.1.1.4.18 CreateGlobalFunctionBinding ( *N*, *V*, *D* )

The *CreateGlobalFunctionBinding* concrete method of a [Global Environment Record](#) *envRec* takes arguments *N* (a String), *V* (an [ECMAScript language value](#)), and *D* (a Boolean) and returns either a [normal completion containing unused](#) or a [throw completion](#). It creates and initializes a mutable binding in the associated [Object Environment Record](#) and records the bound name in the associated [[VarNames]] [List](#). If a binding already exists, it is replaced. It performs the following steps when called:

1. Let *ObjRec* be *envRec*.[[ObjectRecord]].
2. Let *globalObject* be *ObjRec*.[[BindingObject]].

3. Let *existingProp* be ? *globalObject*.[[GetOwnProperty]](*N*).
4. If *existingProp* is **undefined** or *existingProp*.[[Configurable]] is **true**, then
  - a. Let *desc* be the PropertyDescriptor { [[Value]]: *V*, [[Writable]]: **true**, [[Enumerable]]: **true**, [[Configurable]]: *D* }.
5. Else,
  - a. Let *desc* be the PropertyDescriptor { [[Value]]: *V* }.
6. Perform ? *DefinePropertyOrThrow*(*globalObject*, *N*, *desc*).
7. Perform ? *Set*(*globalObject*, *N*, *V*, **false**).
8. If *envRec*.[[VarNames]] does not contain *N*, then
  - a. Append *N* to *envRec*.[[VarNames]].
9. Return unused.

**NOTE** Global function declarations are always represented as own properties of the *global object*. If possible, an existing own property is reconfigured to have a standard set of attribute values. Step 7 is equivalent to what calling the *InitializeBinding* concrete method would do and if *globalObject* is a Proxy will produce the same sequence of Proxy trap calls.

### 9.1.1.5 Module Environment Records

A *Module Environment Record* is a *Declarative Environment Record* that is used to represent the outer scope of an ECMAScript *Module*. In addition to normal mutable and immutable bindings, Module Environment Records also provide immutable import bindings which are bindings that provide indirect access to a target binding that exists in another *Environment Record*.

Module Environment Records support all of the *Declarative Environment Record* methods listed in Table 16 and share the same specifications for all of those methods except for *GetBindingValue*, *DeleteBinding*, *HasThisBinding* and *GetThisBinding*. In addition, Module Environment Records support the methods listed in Table 22:

Table 22: Additional Methods of *Module Environment Records*

Method	Purpose
<i>CreateImportBinding</i> ( <i>N</i> , <i>M</i> , <i>N2</i> )	Create an immutable indirect binding in a <i>Module Environment Record</i> . The String value <i>N</i> is the text of the bound name. <i>M</i> is a <i>Module Record</i> , and <i>N2</i> is a binding that exists in <i>M</i> 's <i>Module Environment Record</i> .
<i>GetThisBinding</i> ()	Return the value of this <i>Environment Record</i> 's <b>this</b> binding.

The behaviour of the additional concrete specification methods for Module Environment Records are defined by the following algorithms:

#### 9.1.1.5.1 *GetBindingValue* ( *N*, *S* )

The *GetBindingValue* concrete method of a *Module Environment Record* *envRec* takes arguments *N* (a String) and *S* (a Boolean) and returns either a *normal completion* containing an ECMAScript language value or a *throw completion*. It returns the value of its bound identifier whose name is *N*. However, if the binding is an indirect binding the value of the target binding is returned. If the binding exists but is uninitialized a **ReferenceError** is thrown. It performs the following steps when called:

1. **Assert**: *S* is **true**.
2. **Assert**: *envRec* has a binding for *N*.
3. If the binding for *N* is an indirect binding, then
  - a. Let *M* and *N2* be the indirection values provided when this binding for *N* was created.
  - b. Let *targetEnv* be *M*.[[Environment]].



- c. If *targetEnv* is empty, throw a **ReferenceError** exception.
  - d. Return ? *targetEnv*.GetBindingValue(*N2*, **true**).
4. If the binding for *N* in *envRec* is an uninitialized binding, throw a **ReferenceError** exception.
  5. Return the value currently bound to *N* in *envRec*.

NOTE *S* will always be **true** because a *Module* is always **strict mode code**.

#### 9.1.1.5.2 DeleteBinding ( *N* )

The DeleteBinding concrete method of a **Module Environment Record** is never used within this specification.

NOTE **Module Environment Records** are only used within strict code and an **early error** rule prevents the delete operator, in strict code, from being applied to a **Reference Record** that would resolve to a **Module Environment Record** binding. See 13.5.1.1.

#### 9.1.1.5.3 HasThisBinding ( )

The HasThisBinding concrete method of a **Module Environment Record** *envRec* takes no arguments and returns **true**. It performs the following steps when called:

1. Return **true**.

NOTE **Module Environment Records** always provide a **this** binding.

#### 9.1.1.5.4 GetThisBinding ( )

The GetThisBinding concrete method of a **Module Environment Record** *envRec* takes no arguments and returns a **normal completion containing undefined**. It performs the following steps when called:

1. Return **undefined**.

#### 9.1.1.5.5 CreateImportBinding ( *N*, *M*, *N2* )

The CreateImportBinding concrete method of a **Module Environment Record** *envRec* takes arguments *N* (a String), *M* (a **Module Record**), and *N2* (a String) and returns **unused**. It creates a new initialized immutable indirect binding for the name *N*. A binding must not already exist in this **Environment Record** for *N*. *N2* is the name of a binding that exists in *M*'s **Module Environment Record**. Accesses to the value of the new binding will indirectly access the bound value of the target binding. It performs the following steps when called:

1. **Assert**: *envRec* does not already have a binding for *N*.
2. **Assert**: When *M*.[[Environment]] is instantiated, it will have a direct binding for *N2*.
3. Create an immutable indirect binding in *envRec* for *N* that references *M* and *N2* as its target binding and record that the binding is initialized.
4. Return **unused**.

## 9.1.2 Environment Record Operations

The following **abstract operations** are used in this specification to operate upon **Environment Records**:

### 9.1.2.1 GetIdentifierReference ( *env*, *name*, *strict* )

The abstract operation GetIdentifierReference takes arguments *env* (an Environment Record or **null**), *name* (a String), and *strict* (a Boolean) and returns either a normal completion containing a Reference Record or a throw completion. It performs the following steps when called:

1. If *env* is **null**, then
  - a. Return the Reference Record { [[Base]]: unresolvable, [[ReferencedName]]: *name*, [[Strict]]: *strict*, [[ThisValue]]: empty }.
2. Let *exists* be ? *env*.HasBinding(*name*).
3. If *exists* is **true**, then
  - a. Return the Reference Record { [[Base]]: *env*, [[ReferencedName]]: *name*, [[Strict]]: *strict*, [[ThisValue]]: empty }.
4. Else,
  - a. Let *outer* be *env*.[[OuterEnv]].
  - b. Return ? GetIdentifierReference(*outer*, *name*, *strict*).

### 9.1.2.2 NewDeclarativeEnvironment ( *E* )

The abstract operation NewDeclarativeEnvironment takes argument *E* (an Environment Record or **null**) and returns a Declarative Environment Record. It performs the following steps when called:

1. Let *env* be a new Declarative Environment Record containing no bindings.
2. Set *env*.[[OuterEnv]] to *E*.
3. Return *env*.

### 9.1.2.3 NewObjectEnvironment ( *O*, *W*, *E* )

The abstract operation NewObjectEnvironment takes arguments *O* (an Object), *W* (a Boolean), and *E* (an Environment Record or **null**) and returns an Object Environment Record. It performs the following steps when called:

1. Let *env* be a new Object Environment Record.
2. Set *env*.[[BindingObject]] to *O*.
3. Set *env*.[[IsWithEnvironment]] to *W*.
4. Set *env*.[[OuterEnv]] to *E*.
5. Return *env*.

### 9.1.2.4 NewFunctionEnvironment ( *F*, *newTarget* )

The abstract operation NewFunctionEnvironment takes arguments *F* (an ECMAScript function) and *newTarget* (an Object or **undefined**) and returns a Function Environment Record. It performs the following steps when called:

1. Let *env* be a new Function Environment Record containing no bindings.
2. Set *env*.[[FunctionObject]] to *F*.
3. If *F*.[[ThisMode]] is lexical, set *env*.[[ThisBindingStatus]] to lexical.
4. Else, set *env*.[[ThisBindingStatus]] to uninitialized.
5. Set *env*.[[NewTarget]] to *newTarget*.
6. Set *env*.[[OuterEnv]] to *F*.[[Environment]].
7. Return *env*.

### 9.1.2.5 NewGlobalEnvironment ( *G*, *thisValue* )

The abstract operation `NewGlobalEnvironment` takes arguments *G* (an Object) and *thisValue* (an Object) and returns a `Global Environment Record`. It performs the following steps when called:

1. Let *objRec* be `NewObjectEnvironment(G, false, null)`.
2. Let *dclRec* be `NewDeclarativeEnvironment(null)`.
3. Let *env* be a new `Global Environment Record`.
4. Set *env*.[[ObjectRecord]] to *objRec*.
5. Set *env*.[[GlobalThisValue]] to *thisValue*.
6. Set *env*.[[DeclarativeRecord]] to *dclRec*.
7. Set *env*.[[VarNames]] to a new empty `List`.
8. Set *env*.[[OuterEnv]] to **null**.
9. Return *env*.

### 9.1.2.6 NewModuleEnvironment ( *E* )

The abstract operation `NewModuleEnvironment` takes argument *E* (an `Environment Record`) and returns a `Module Environment Record`. It performs the following steps when called:

1. Let *env* be a new `Module Environment Record` containing no bindings.
2. Set *env*.[[OuterEnv]] to *E*.
3. Return *env*.

## 9.2 PrivateEnvironment Records

A `PrivateEnvironment Record` is a specification mechanism used to track `Private Names` based upon the lexical nesting structure of `ClassDeclarations` and `ClassExpressions` in ECMAScript code. They are similar to, but distinct from, `Environment Records`. Each `PrivateEnvironment Record` is associated with a `ClassDeclaration` or `ClassExpression`. Each time such a class is evaluated, a new `PrivateEnvironment Record` is created to record the `Private Names` declared by that class.

Each `PrivateEnvironment Record` has the fields defined in [Table 23](#).

**Table 23: PrivateEnvironment Record Fields**

Field Name	Value Type	Meaning
[[OuterPrivateEnvironment]]	a <code>PrivateEnvironment Record</code> or <b>null</b>	The <code>PrivateEnvironment Record</code> of the nearest containing class. <b>null</b> if the class with which this <code>PrivateEnvironment Record</code> is associated is not contained in any other class.
[[Names]]	a <code>List</code> of <code>Private Names</code>	The <code>Private Names</code> declared by this class.

### 9.2.1 PrivateEnvironment Record Operations

The following `abstract operations` are used in this specification to operate upon `PrivateEnvironment Records`:

### 9.2.1.1 NewPrivateEnvironment ( *outerPrivEnv* )

The abstract operation NewPrivateEnvironment takes argument *outerPrivEnv* (a PrivateEnvironment Record or null) and returns a PrivateEnvironment Record. It performs the following steps when called:

1. Let *names* be a new empty List.
2. Return the PrivateEnvironment Record { [[OuterPrivateEnvironment]]: *outerPrivEnv*, [[Names]]: *names* }.

### 9.2.1.2 ResolvePrivateIdentifier ( *privEnv*, *identifier* )

The abstract operation ResolvePrivateIdentifier takes arguments *privEnv* (a PrivateEnvironment Record) and *identifier* (a String) and returns a Private Name. It performs the following steps when called:

1. Let *names* be *privEnv*.[[Names]].
2. For each Private Name *pn* of *names*, do
  - a. If *pn*.[[Description]] is *identifier*, then
    - i. Return *pn*.
3. Let *outerPrivEnv* be *privEnv*.[[OuterPrivateEnvironment]].
4. Assert: *outerPrivEnv* is not null.
5. Return ResolvePrivateIdentifier(*outerPrivEnv*, *identifier*).

## 9.3 Realms

Before it is evaluated, all ECMAScript code must be associated with a *realm*. Conceptually, a *realm* consists of a set of intrinsic objects, an ECMAScript global environment, all of the ECMAScript code that is loaded within the scope of that global environment, and other associated state and resources.

A *realm* is represented in this specification as a *Realm Record* with the fields specified in Table 24:

Table 24: Realm Record Fields

Field Name	Value	Meaning
[[Intrinsics]]	a Record whose field names are intrinsic keys and whose values are objects	The intrinsic values used by code associated with this realm
[[GlobalObject]]	an Object or <b>undefined</b>	The global object for this realm
[[GlobalEnv]]	a Global Environment Record	The global environment for this realm
[[TemplateMap]]	a List of Records with fields [[Site]] (a TemplateLiteral Parse Node) and [[Array]] (an Array)	<p>Template objects are canonicalized separately for each realm using its Realm Record's [[TemplateMap]]. Each [[Site]] value is a Parse Node that is a TemplateLiteral. The associated [[Array]] value is the corresponding template object that is passed to a tag function.</p> <div style="border: 1px solid green; background-color: #e0ffe0; padding: 5px;"> <p>NOTE 1 Once a Parse Node becomes unreachable, the corresponding [[Array]] is also unreachable, and it would be unobservable if an implementation removed the pair from the [[TemplateMap]] list.</p> </div>

Table 24 (continued)

Field Name	Value	Meaning
[[LoadedModules]]	a List of Records with fields [[Specifier]] (a String) and [[Module]] (a Module Record)	<p>A map from the specifier strings imported by this realm to the resolved Module Record. The list does not contain two different Records with the same [[Specifier]].</p> <p><b>NOTE 2</b> As mentioned in HostLoadImportedModule (16.2.1.8 Note 1), [[LoadedModules]] in Realm Records is only used when running an <code>import()</code> expression in a context where there is no active script or module.</p>
[[HostDefined]]	anything (default value is <b>undefined</b> )	Field reserved for use by hosts that need to associate additional information with a Realm Record.

### 9.3.1 CreateRealm ( )

The abstract operation CreateRealm takes no arguments and returns a Realm Record. It performs the following steps when called:

1. Let *realmRec* be a new Realm Record.
2. Perform CreateIntrinsics(*realmRec*).
3. Set *realmRec*.[[GlobalObject]] to **undefined**.
4. Set *realmRec*.[[GlobalEnv]] to **undefined**.
5. Set *realmRec*.[[TemplateMap]] to a new empty List.
6. Return *realmRec*.

### 9.3.2 CreateIntrinsics ( *realmRec* )

The abstract operation CreateIntrinsics takes argument *realmRec* (a Realm Record) and returns unused. It performs the following steps when called:

1. Set *realmRec*.[[Intrinsics]] to a new Record.
2. Set fields of *realmRec*.[[Intrinsics]] with the values listed in Table 6. The field names are the names listed in column one of the table. The value of each field is a new object value fully and recursively populated with property values as defined by the specification of each object in clauses 19 through 28. All object property values are newly created object values. All values that are built-in function objects are created by performing CreateBuiltinFunction(*steps*, *length*, *name*, *slots*, *realmRec*, *prototype*) where *steps* is the definition of that function provided by this specification, *name* is the initial value of the function's "name" property, *length* is the initial value of the function's "length" property, *slots* is a list of the names, if any, of the function's specified internal slots, and *prototype* is the specified value of the function's [[Prototype]] internal slot. The creation of the intrinsics and their properties must be ordered to avoid any dependencies upon objects that have not yet been created.
3. Perform AddRestrictedFunctionProperties(*realmRec*.[[Intrinsics]].[[%Function.prototype%]], *realmRec*).
4. Return unused.

### 9.3.3 SetRealmGlobalObject ( *realmRec*, *globalObj*, *thisValue* )

The abstract operation SetRealmGlobalObject takes arguments *realmRec* (a [Realm Record](#)), *globalObj* (an Object or **undefined**), and *thisValue* (an Object or **undefined**) and returns unused. It performs the following steps when called:

1. If *globalObj* is **undefined**, then
  - a. Let *intrinsic*s be *realmRec*.[[Intrinsic]].
  - b. Set *globalObj* to [OrdinaryObjectCreate](#)(*intrinsic*s.[[%Object.prototype%]]).
2. [Assert](#): *globalObj* is an Object.
3. If *thisValue* is **undefined**, set *thisValue* to *globalObj*.
4. Set *realmRec*.[[GlobalObject]] to *globalObj*.
5. Let *newGlobalEnv* be [NewGlobalEnvironment](#)(*globalObj*, *thisValue*).
6. Set *realmRec*.[[GlobalEnv]] to *newGlobalEnv*.
7. Return unused.

### 9.3.4 SetDefaultGlobalBindings ( *realmRec* )

The abstract operation SetDefaultGlobalBindings takes argument *realmRec* (a [Realm Record](#)) and returns either a [normal completion containing](#) an Object or a [throw completion](#). It performs the following steps when called:

1. Let *global* be *realmRec*.[[GlobalObject]].
2. For each property of the Global Object specified in clause 19, do
  - a. Let *name* be the String value of the [property name](#).
  - b. Let *desc* be the fully populated data [Property Descriptor](#) for the property, containing the specified attributes for the property. For properties listed in 19.2, 19.3, or 19.4 the value of the [[Value]] attribute is the corresponding intrinsic object from *realmRec*.
  - c. Perform ? [DefinePropertyOrThrow](#)(*global*, *name*, *desc*).
3. Return *global*.

## 9.4 Execution Contexts

An *execution context* is a specification device that is used to track the runtime evaluation of code by an ECMAScript implementation. At any point in time, there is at most one execution context per [agent](#) that is actually executing code. This is known as the [agent's running execution context](#). All references to the [running execution context](#) in this specification denote the [running execution context](#) of the [surrounding agent](#).

The *execution context stack* is used to track execution contexts. The [running execution context](#) is always the top element of this stack. A new execution context is created whenever control is transferred from the executable code associated with the currently [running execution context](#) to executable code that is not associated with that execution context. The newly created execution context is pushed onto the stack and becomes the [running execution context](#).

An execution context contains whatever implementation specific state is necessary to track the execution progress of its associated code. Each execution context has at least the state components listed in [Table 25](#).

**Table 25: State Components for All Execution Contexts**

Component	Purpose
code evaluation state	Any state needed to perform, suspend, and resume evaluation of the code associated with this <a href="#">execution context</a> .
Function	If this <a href="#">execution context</a> is evaluating the code of a <a href="#">function object</a> , then the value of this component is that <a href="#">function object</a> . If the context is evaluating the code of a <i>Script</i> or <i>Module</i> , the value is <b>null</b> .
Realm	The <a href="#">Realm Record</a> from which associated code accesses ECMAScript resources.
ScriptOrModule	The <a href="#">Module Record</a> or <a href="#">Script Record</a> from which associated code originates. If there is no originating script or module, as is the case for the original <a href="#">execution context</a> created in <a href="#">InitializeHostDefinedRealm</a> , the value is <b>null</b> .

Evaluation of code by the [running execution context](#) may be suspended at various points defined within this specification. Once the [running execution context](#) has been suspended a different execution context may become the [running execution context](#) and commence evaluating its code. At some later time a suspended execution context may again become the [running execution context](#) and continue evaluating its code at the point where it had previously been suspended. Transition of the [running execution context](#) status among execution contexts usually occurs in stack-like last-in/first-out manner. However, some ECMAScript features require non-LIFO transitions of the [running execution context](#).

The value of the [Realm](#) component of the [running execution context](#) is also called *the current Realm Record*. The value of the [Function](#) component of the [running execution context](#) is also called *the active function object*.

ECMAScript code execution contexts have the additional state components listed in [Table 26](#).

**Table 26: Additional State Components for ECMAScript Code Execution Contexts**

Component	Purpose
LexicalEnvironment	Identifies the <a href="#">Environment Record</a> used to resolve identifier references made by code within this <a href="#">execution context</a> .
VariableEnvironment	Identifies the <a href="#">Environment Record</a> that holds bindings created by <i>VariableStatements</i> within this <a href="#">execution context</a> .
PrivateEnvironment	Identifies the <a href="#">PrivateEnvironment Record</a> that holds <a href="#">Private Names</a> created by <i>ClassElements</i> in the nearest containing class. <b>null</b> if there is no containing class.

The [LexicalEnvironment](#) and [VariableEnvironment](#) components of an execution context are always [Environment Records](#).

Execution contexts representing the evaluation of Generators have the additional state components listed in [Table 27](#).

**Table 27: Additional State Components for Generator Execution Contexts**

Component	Purpose
Generator	The Generator that this <a href="#">execution context</a> is evaluating.

In most situations only the [running execution context](#) (the top of the [execution context stack](#)) is directly manipulated by algorithms within this specification. Hence when the terms “[LexicalEnvironment](#)”, and

“VariableEnvironment” are used without qualification they are in reference to those components of the [running execution context](#).

An execution context is purely a specification mechanism and need not correspond to any particular artefact of an ECMAScript implementation. It is impossible for ECMAScript code to directly access or observe an execution context.

### 9.4.1 GetActiveScriptOrModule ( )

The abstract operation GetActiveScriptOrModule takes no arguments and returns a [Script Record](#), a [Module Record](#), or **null**. It is used to determine the running script or module, based on the [running execution context](#). It performs the following steps when called:

1. If the [execution context stack](#) is empty, return **null**.
2. Let *ec* be the topmost [execution context](#) on the [execution context stack](#) whose ScriptOrModule component is not **null**.
3. If no such [execution context](#) exists, return **null**. Otherwise, return *ec*'s ScriptOrModule.

### 9.4.2 ResolveBinding ( *name* [ , *env* ] )

The abstract operation ResolveBinding takes argument *name* (a String) and optional argument *env* (an [Environment Record](#) or **undefined**) and returns either a [normal completion](#) containing a [Reference Record](#) or a [throw completion](#). It is used to determine the binding of *name*. *env* can be used to explicitly provide the [Environment Record](#) that is to be searched for the binding. It performs the following steps when called:

1. If *env* is not present or *env* is **undefined**, then
  - a. Set *env* to the [running execution context](#)'s LexicalEnvironment.
2. **Assert**: *env* is an [Environment Record](#).
3. If the [source text matched by](#) the syntactic production that is being evaluated is contained in [strict mode code](#), let *strict* be **true**; else let *strict* be **false**.
4. Return ? [GetIdentifierReference](#)(*env*, *name*, *strict*).

**NOTE** The result of ResolveBinding is always a [Reference Record](#) whose `[[ReferencedName]]` field is *name*.

### 9.4.3 GetThisEnvironment ( )

The abstract operation GetThisEnvironment takes no arguments and returns an [Environment Record](#). It finds the [Environment Record](#) that currently supplies the binding of the keyword **this**. It performs the following steps when called:

1. Let *env* be the [running execution context](#)'s LexicalEnvironment.
2. Repeat,
  - a. Let *exists* be *env*.HasThisBinding().
  - b. If *exists* is **true**, return *env*.
  - c. Let *outer* be *env*.[[OuterEnv]].
  - d. **Assert**: *outer* is not **null**.
  - e. Set *env* to *outer*.

**NOTE** The loop in step 2 will always terminate because the list of environments always ends with the global environment which has a **this** binding.



#### 9.4.4 ResolveThisBinding ( )

The abstract operation `ResolveThisBinding` takes no arguments and returns either a [normal completion containing an ECMAScript language value](#) or a [throw completion](#). It determines the binding of the keyword `this` using the `LexicalEnvironment` of the [running execution context](#). It performs the following steps when called:

1. Let `envRec` be `GetThisEnvironment()`.
2. Return ? `envRec.GetThisBinding()`.

#### 9.4.5 GetNewTarget ( )

The abstract operation `GetNewTarget` takes no arguments and returns an `Object` or `undefined`. It determines the `NewTarget` value using the `LexicalEnvironment` of the [running execution context](#). It performs the following steps when called:

1. Let `envRec` be `GetThisEnvironment()`.
2. **Assert:** `envRec` has a `[[NewTarget]]` field.
3. Return `envRec.[[NewTarget]]`.

#### 9.4.6 GetGlobalObject ( )

The abstract operation `GetGlobalObject` takes no arguments and returns an `Object`. It returns the [global object](#) used by the currently [running execution context](#). It performs the following steps when called:

1. Let `currentRealm` be [the current Realm Record](#).
2. Return `currentRealm.[[GlobalObject]]`.

### 9.5 Jobs and Host Operations to Enqueue Jobs

A *Job* is an [Abstract Closure](#) with no parameters that initiates an ECMAScript computation when no other ECMAScript computation is currently in progress.

[Jobs](#) are scheduled for execution by ECMAScript [host environments](#). This specification describes the [host hook `HostEnqueuePromiseJob`](#) to schedule one kind of job; [hosts](#) may define additional [abstract operations](#) which schedule jobs. Such operations accept a [Job Abstract Closure](#) as the parameter and schedule it to be performed at some future time. Their implementations must conform to the following requirements:

- At some future point in time, when there is no [running execution context](#) and the [execution context stack](#) is empty, the implementation must:
  1. Perform any [host-defined](#) preparation steps.
  2. [Invoke](#) the [Job Abstract Closure](#).
  3. Perform any [host-defined](#) cleanup steps, after which the [execution context stack](#) must be empty.
- Only one [Job](#) may be actively undergoing evaluation at any point in time.
- Once evaluation of a [Job](#) starts, it must run to completion before evaluation of any other [Job](#) starts.
- The [Abstract Closure](#) must return a [normal completion](#), implementing its own handling of errors.

**NOTE 1** [Host environments](#) are not required to treat [Jobs](#) uniformly with respect to scheduling. For example, web browsers and Node.js treat Promise-handling [Jobs](#) as a higher priority than other work; future features may add [Jobs](#) that are not treated at such a high priority.

At any particular time, [scriptOrModule](#) (a [Script Record](#), a [Module Record](#), or `null`) is the *active script or module* if all of the following conditions are true:

- `GetActiveScriptOrModule()` is *scriptOrModule*.
- If *scriptOrModule* is a *Script Record* or *Module Record*, let *ec* be the topmost *execution context* on the *execution context stack* whose *ScriptOrModule* component is *scriptOrModule*. The *Realm* component of *ec* is *scriptOrModule*.`[[Realm]]`.

At any particular time, an execution is *prepared to evaluate ECMAScript code* if all of the following conditions are true:

- The *execution context stack* is not empty.
- The *Realm* component of the topmost *execution context* on the *execution context stack* is a *Realm Record*.

**NOTE 2** *Host environments* may prepare an execution to evaluate code by pushing *execution contexts* onto the *execution context stack*. The specific steps are *implementation-defined*.

The specific choice of *Realm* is up to the *host environment*. This initial *execution context* and *Realm* is only in use before any callback function is invoked. When a callback function related to a *Job*, like a Promise handler, is invoked, the invocation pushes its own *execution context* and *Realm*.

Particular kinds of *Jobs* have additional conformance requirements.

### 9.5.1 JobCallback Records

A *JobCallback Record* is a *Record* value used to store a *function object* and a *host-defined* value. *Function objects* that are invoked via a *Job* enqueued by the *host* may have additional *host-defined* context. To propagate the state, *Job Abstract Closures* should not capture and call *function objects* directly. Instead, use *HostMakeJobCallback* and *HostCallJobCallback*.

**NOTE** The WHATWG HTML specification (<https://html.spec.whatwg.org/>), for example, uses the *host-defined* value to propagate the incumbent settings object for Promise callbacks.

*JobCallback Records* have the fields listed in [Table 28](#).

**Table 28: JobCallback Record Fields**

Field Name	Value	Meaning
<code>[[Callback]]</code>	a <i>function object</i>	The function to invoke when the <i>Job</i> is invoked.
<code>[[HostDefined]]</code>	anything (default value is empty)	Field reserved for use by <i>hosts</i> .

### 9.5.2 HostMakeJobCallback ( *callback* )

The *host-defined* abstract operation *HostMakeJobCallback* takes argument *callback* (a *function object*) and returns a *JobCallback Record*.

An implementation of *HostMakeJobCallback* must conform to the following requirements:

- It must return a *JobCallback Record* whose `[[Callback]]` field is *callback*.

The default implementation of *HostMakeJobCallback* performs the following steps when called:

1. Return the *JobCallback Record* { `[[Callback]]`: *callback*, `[[HostDefined]]`: empty }.

ECMAScript *hosts* that are not web browsers must use the default implementation of *HostMakeJobCallback*.

NOTE This is called at the time that the callback is passed to the function that is responsible for its being eventually scheduled and run. For example, `promise.then(thenAction)` calls `MakeJobCallback` on `thenAction` at the time of invoking `Promise.prototype.then`, not at the time of scheduling the reaction `Job`.

### 9.5.3 HostCallJobCallback ( *jobCallback*, *V*, *argumentsList* )

The *host-defined* abstract operation `HostCallJobCallback` takes arguments *jobCallback* (a *JobCallback Record*), *V* (an *ECMAScript language value*), and *argumentsList* (a *List of ECMAScript language values*) and returns either a *normal completion* containing an *ECMAScript language value* or a *throw completion*.

An implementation of `HostCallJobCallback` must conform to the following requirements:

- It must perform and return the result of `Call(jobCallback.[[Callback]], V, argumentsList)`.

NOTE This requirement means that *hosts* cannot change the `[[Call]]` behaviour of *function objects* defined in this specification.

The default implementation of `HostCallJobCallback` performs the following steps when called:

1. *Assert*: `IsCallable(jobCallback.[[Callback]])` is **true**.
2. Return ? `Call(jobCallback.[[Callback]], V, argumentsList)`.

ECMAScript *hosts* that are not web browsers must use the default implementation of `HostCallJobCallback`.

### 9.5.4 HostEnqueuePromiseJob ( *job*, *realm* )

The *host-defined* abstract operation `HostEnqueuePromiseJob` takes arguments *job* (a *Job Abstract Closure*) and *realm* (a *Realm Record* or **null**) and returns **unused**. It schedules *job* to be performed at some future time. The *Abstract Closures* used with this algorithm are intended to be related to the handling of Promises, or otherwise, to be scheduled with equal priority to Promise handling operations.

An implementation of `HostEnqueuePromiseJob` must conform to the requirements in 9.5 as well as the following:

- If *realm* is not **null**, each time *job* is invoked the implementation must perform *implementation-defined* steps such that execution is *prepared to evaluate ECMAScript code* at the time of *job*'s invocation.
- Let *scriptOrModule* be `GetActiveScriptOrModule()` at the time `HostEnqueuePromiseJob` is invoked. If *realm* is not **null**, each time *job* is invoked the implementation must perform *implementation-defined* steps such that *scriptOrModule* is the *active script or module* at the time of *job*'s invocation.
- *Jobs* must run in the same order as the `HostEnqueuePromiseJob` invocations that scheduled them.

NOTE The *realm* for *Jobs* returned by `NewPromiseResolveThenableJob` is usually the result of calling `GetFunctionRealm` on the *then* function object. The *realm* for *Jobs* returned by `NewPromiseReactionJob` is usually the result of calling `GetFunctionRealm` on the handler if the handler is not **undefined**. If the handler is **undefined**, *realm* is **null**. For both kinds of *Jobs*, when `GetFunctionRealm` completes abnormally (i.e. called on a revoked Proxy), *realm* is the current *Realm* at the time of the `GetFunctionRealm` call. When the *realm* is **null**, no user ECMAScript code will be evaluated and no new ECMAScript objects (e.g. Error objects) will be created. The WHATWG HTML specification (<https://html.spec.whatwg.org/>), for example, uses *realm* to check for the ability to run script and for the *entry* concept.

## 9.6 InitializeHostDefinedRealm ( )

The abstract operation InitializeHostDefinedRealm takes no arguments and returns either a [normal completion containing unused](#) or a [throw completion](#). It performs the following steps when called:

1. Let *realm* be [CreateRealm\(\)](#).
2. Let *newContext* be a new [execution context](#).
3. Set the Function of *newContext* to **null**.
4. Set the [Realm](#) of *newContext* to *realm*.
5. Set the [ScriptOrModule](#) of *newContext* to **null**.
6. Push *newContext* onto the [execution context stack](#); *newContext* is now the [running execution context](#).
7. If the [host](#) requires use of an [exotic object](#) to serve as *realm*'s [global object](#), let *global* be such an object created in a [host-defined](#) manner. Otherwise, let *global* be **undefined**, indicating that an [ordinary object](#) should be created as the [global object](#).
8. If the [host](#) requires that the **this** binding in *realm*'s global scope return an object other than the [global object](#), let *thisValue* be such an object created in a [host-defined](#) manner. Otherwise, let *thisValue* be **undefined**, indicating that *realm*'s global **this** binding should be the [global object](#).
9. Perform [SetRealmGlobalObject\(realm, global, thisValue\)](#).
10. Let *globalObj* be ? [SetDefaultGlobalBindings\(realm\)](#).
11. Create any [host-defined global object](#) properties on *globalObj*.
12. Return unused.

## 9.7 Agents

An *agent* comprises a set of ECMAScript [execution contexts](#), an [execution context stack](#), a [running execution context](#), an *Agent Record*, and an [executing thread](#). Except for the [executing thread](#), the constituents of an *agent* belong exclusively to that *agent*.

An *agent*'s [executing thread](#) executes a job on the *agent*'s [execution contexts](#) independently of other *agents*, except that an [executing thread](#) may be used as the [executing thread](#) by multiple *agents*, provided none of the *agents* sharing the thread have an *Agent Record* whose [\[\[CanBlock\]\]](#) field is **true**.

**NOTE 1** Some web browsers share a single [executing thread](#) across multiple unrelated tabs of a browser window, for example.

While an *agent*'s [executing thread](#) executes jobs, the *agent* is the *surrounding agent* for the code in those jobs. The code uses the *surrounding agent* to access the specification-level execution objects held within the *agent*: the [running execution context](#), the [execution context stack](#), and the *Agent Record*'s fields.

An *agent signifier* is a globally-unique opaque value used to identify an *Agent*.

**Table 29: Agent Record Fields**

Field Name	Value	Meaning
<a href="#">[[LittleEndian]]</a>	a Boolean	The default value computed for the <i>isLittleEndian</i> parameter when it is needed by the algorithms <a href="#">GetValueFromBuffer</a> and <a href="#">SetValueInBuffer</a> . The choice is <a href="#">implementation-defined</a> and should be the alternative that is most efficient for the implementation. Once the value has been observed it cannot change.
<a href="#">[[CanBlock]]</a>	a Boolean	Determines whether the <i>agent</i> can block or not.
<a href="#">[[Signifier]]</a>	an <i>agent signifier</i>	Uniquely identifies the <i>agent</i> within its <i>agent cluster</i> .

Table 29 (continued)

Field Name	Value	Meaning
[[IsLockFree1]]	a Boolean	<b>true</b> if atomic operations on one-byte values are lock-free, <b>false</b> otherwise.
[[IsLockFree2]]	a Boolean	<b>true</b> if atomic operations on two-byte values are lock-free, <b>false</b> otherwise.
[[IsLockFree8]]	a Boolean	<b>true</b> if atomic operations on eight-byte values are lock-free, <b>false</b> otherwise.
[[CandidateExecution]]	a <a href="#">candidate execution Record</a>	See the <a href="#">memory model</a> .
[[KeptAlive]]	a <a href="#">List</a> of either Objects or Symbols	Initially a new empty <a href="#">List</a> , representing the list of objects and/or symbols to be kept alive until the end of the current <a href="#">Job</a>

Once the values of [[Signifier]], [[IsLockFree1]], and [[IsLockFree2]] have been observed by any [agent](#) in the [agent cluster](#) they cannot change.

NOTE 2 The values of [[IsLockFree1]] and [[IsLockFree2]] are not necessarily determined by the hardware, but may also reflect implementation choices that can vary over time and between ECMAScript implementations.

There is no [[IsLockFree4]] field: 4-byte atomic operations are always lock-free.

In practice, if an atomic operation is implemented with any type of lock the operation is not lock-free. Lock-free does not imply wait-free: there is no upper bound on how many machine steps may be required to complete a lock-free atomic operation.

That an atomic access of size  $n$  is lock-free does not imply anything about the (perceived) atomicity of non-atomic accesses of size  $n$ , specifically, non-atomic accesses may still be performed as a sequence of several separate memory accesses. See [ReadSharedMemory](#) and [WriteSharedMemory](#) for details.

NOTE 3 An [agent](#) is a specification mechanism and need not correspond to any particular artefact of an ECMAScript implementation.

### 9.7.1 AgentSignifier ( )

The abstract operation AgentSignifier takes no arguments and returns an [agent signifier](#). It performs the following steps when called:

1. Let [AR](#) be the [Agent Record](#) of the [surrounding agent](#).
2. Return [AR](#).[[Signifier]].

### 9.7.2 AgentCanSuspend ( )

The abstract operation AgentCanSuspend takes no arguments and returns a Boolean. It performs the following steps when called:

1. Let [AR](#) be the [Agent Record](#) of the [surrounding agent](#).

2. Return `AR.[[CanBlock]]`.

**NOTE** In some environments it may not be reasonable for a given `agent` to suspend. For example, in a web browser environment, it may be reasonable to disallow suspending a document's main event handling thread, while still allowing workers' event handling threads to suspend.

## 9.8 Agent Clusters

An *agent cluster* is a maximal set of `agents` that can communicate by operating on shared memory.

**NOTE 1** Programs within different `agents` may share memory by unspecified means. At a minimum, the backing memory for `SharedArrayBuffers` can be shared among the `agents` in the cluster.

There may be `agents` that can communicate by message passing that cannot share memory; they are never in the same agent cluster.

Every `agent` belongs to exactly one agent cluster.

**NOTE 2** The `agents` in a cluster need not all be alive at some particular point in time. If `agent A` creates another `agent B`, after which `A` terminates and `B` creates `agent C`, the three `agents` are in the same cluster if `A` could share some memory with `B` and `B` could share some memory with `C`.

All `agents` within a cluster must have the same value for the `[[LittleEndian]]` field in their respective `Agent Records`.

**NOTE 3** If different `agents` within an agent cluster have different values of `[[LittleEndian]]` it becomes hard to use shared memory for multi-byte data.

All `agents` within a cluster must have the same values for the `[[IsLockFree1]]` field in their respective `Agent Records`; similarly for the `[[IsLockFree2]]` field.

All `agents` within a cluster must have different values for the `[[Signifier]]` field in their respective `Agent Records`.

An embedding may deactivate (stop forward progress) or activate (resume forward progress) an `agent` without the `agent's` knowledge or cooperation. If the embedding does so, it must not leave some `agents` in the cluster active while other `agents` in the cluster are deactivated indefinitely.

**NOTE 4** The purpose of the preceding restriction is to avoid a situation where an `agent` deadlocks or starves because another `agent` has been deactivated. For example, if an HTML shared worker that has a lifetime independent of documents in any windows were allowed to share memory with the dedicated worker of such an independent document, and the document and its dedicated worker were to be deactivated while the dedicated worker holds a lock (say, the document is pushed into its window's history), and the shared worker then tries to acquire the lock, then the shared worker will be blocked until the dedicated worker is activated again, if ever. Meanwhile other workers trying to access the shared worker from other windows will starve.

The implication of the restriction is that it will not be possible to share memory between `agents` that don't belong to the same suspend/wake collective within the embedding.

An embedding may terminate an `agent` without any of the `agent's` cluster's other `agents'` prior knowledge or cooperation. If an `agent` is terminated not by programmatic action of its own or of another `agent` in the cluster

but by forces external to the cluster, then the embedding must choose one of two strategies: Either terminate all the [agents](#) in the cluster, or provide reliable APIs that allow the [agents](#) in the cluster to coordinate so that at least one remaining member of the cluster will be able to detect the termination, with the termination data containing enough information to identify the [agent](#) that was terminated.

NOTE 5 Examples of that type of termination are: operating systems or users terminating [agents](#) that are running in separate processes; the embedding itself terminating an [agent](#) that is running in-process with the other [agents](#) when per-[agent](#) resource accounting indicates that the [agent](#) is runaway.

Prior to any evaluation of any ECMAScript code by any [agent](#) in a cluster, the `[[CandidateExecution]]` field of the [Agent Record](#) for all [agents](#) in the cluster is set to the initial [candidate execution](#). The initial [candidate execution](#) is an [empty candidate execution](#) whose `[[EventsRecords]]` field is a [List](#) containing, for each [agent](#), an [Agent Events Record](#) whose `[[AgentSignifier]]` field is that [agent's agent signifier](#), and whose `[[EventList]]` and `[[AgentSynchronizesWith]]` fields are empty [Lists](#).

NOTE 6 All [agents](#) in an agent cluster share the same [candidate execution](#) in its [Agent Record's](#) `[[CandidateExecution]]` field. The [candidate execution](#) is a specification mechanism used by the [memory model](#).

NOTE 7 An agent cluster is a specification mechanism and need not correspond to any particular artefact of an ECMAScript implementation.

## 9.9 Forward Progress

For an [agent](#) to *make forward progress* is for it to perform an evaluation step according to this specification.

An [agent](#) becomes *blocked* when its [running execution context](#) waits synchronously and indefinitely for an external event. Only [agents](#) whose [Agent Record's](#) `[[CanBlock]]` field is **true** can become blocked in this sense. An *unblocked* [agent](#) is one that is not blocked.

Implementations must ensure that:

- every unblocked [agent](#) with a dedicated [executing thread](#) eventually makes forward progress
- in a set of [agents](#) that share an [executing thread](#), one [agent](#) eventually makes forward progress
- an [agent](#) does not cause another [agent](#) to become blocked except via explicit APIs that provide blocking.

NOTE This, along with the liveness guarantee in the [memory model](#), ensures that all `SeqCst` writes eventually become observable to all [agents](#).

## 9.10 Processing Model of WeakRef and FinalizationRegistry Targets

### 9.10.1 Objectives

This specification does not make any guarantees that any object or symbol will be garbage collected. Objects or symbols which are not [live](#) may be released after long periods of time, or never at all. For this reason, this specification uses the term "may" when describing behaviour triggered by garbage collection.

The semantics of [WeakRefs](#) and [FinalizationRegistries](#) is based on two operations which happen at particular points in time:

- When `WeakRef.prototype.deref` is called, the referent (if `undefined` is not returned) is kept alive so that subsequent, synchronous accesses also return the same value. This list is reset when synchronous work is done using the `ClearKeptObjects` abstract operation.
- When an object or symbol which is registered with a `FinalizationRegistry` becomes unreachable, a call of the `FinalizationRegistry`'s cleanup callback may eventually be made, after synchronous ECMAScript execution completes. The `FinalizationRegistry` cleanup is performed with the `CleanupFinalizationRegistry` abstract operation.

Neither of these actions (`ClearKeptObjects` or `CleanupFinalizationRegistry`) may interrupt synchronous ECMAScript execution. Because `hosts` may assemble longer, synchronous ECMAScript execution runs, this specification defers the scheduling of `ClearKeptObjects` and `CleanupFinalizationRegistry` to the `host environment`.

Some ECMAScript implementations include garbage collector implementations which run in the background, including when ECMAScript is idle. Letting the `host environment` schedule `CleanupFinalizationRegistry` allows it to resume ECMAScript execution in order to run finalizer work, which may free up held values, reducing overall memory usage.

## 9.10.2 Liveness

For some set of objects and/or symbols  $S$  a *hypothetical WeakRef-oblivious* execution with respect to  $S$  is an execution whereby the abstract operation `WeakRefDeref` of a `WeakRef` whose referent is an element of  $S$  always returns `undefined`.

NOTE 1 `WeakRef`-obliviousness, together with liveness, capture two notions. One, that a `WeakRef` itself does not keep its referent alive. Two, that cycles in liveness does not imply that a value is live. To be concrete, if determining  $v$ 's liveness depends on determining the liveness of a `WeakRef` referent,  $r$ ,  $r$ 's liveness cannot assume  $v$ 's liveness, which would be circular reasoning.

NOTE 2 `WeakRef`-obliviousness is defined on sets of objects or symbols instead of individual values to account for cycles. If it were defined on individual values, then a `WeakRef` referent in a cycle will be considered live even though its identity is only observed via other `WeakRef` referents in the cycle.

NOTE 3 Colloquially, we say that an individual object or symbol is live if every set containing it is live.

At any point during evaluation, a set of objects and/or symbols  $S$  is considered *live* if either of the following conditions is met:

- Any element in  $S$  is included in any `agent`'s `[[KeptAlive]] List`.
- There exists a valid future hypothetical `WeakRef`-oblivious execution with respect to  $S$  that observes the identity of any value in  $S$ .

NOTE 4 The second condition above intends to capture the intuition that a value is live if its identity is observable via non-`WeakRef` means. A value's identity may be observed by observing a strict equality comparison or observing the value being used as key in a `Map`.



NOTE 5 Presence of an object or a symbol in a field, an internal slot, or a property does not imply that the value is live. For example if the value in question is never passed back to the program, then it cannot be observed.

This is the case for keys in a WeakMap, members of a WeakSet, as well as the `[[WeakRefTarget]]` and `[[UnregisterToken]]` fields of a `FinalizationRegistry` Cell record.

The above definition implies that, if a key in a WeakMap is not live, then its corresponding value is not necessarily live either.

NOTE 6 Liveness is the lower bound for guaranteeing which `WeakRefs` engines must not empty. Liveness as defined here is undecidable. In practice, engines use conservative approximations such as reachability. There is expected to be significant implementation leeway.

### 9.10.3 Execution

At any time, if a set of objects and/or symbols `S` is not `live`, an ECMAScript implementation may perform the following steps atomically:

1. For each element `value` of `S`, do
  - a. For each `WeakRef ref` such that `ref.[[WeakRefTarget]]` is `value`, do
    - i. Set `ref.[[WeakRefTarget]]` to empty.
  - b. For each `FinalizationRegistry fg` such that `fg.[[Cells]]` contains a `Record cell` such that `cell.[[WeakRefTarget]]` is `value`, do
    - i. Set `cell.[[WeakRefTarget]]` to empty.
    - ii. Optionally, perform `HostEnqueueFinalizationRegistryCleanupJob(fg)`.
  - c. For each WeakMap `map` such that `map.[[WeakMapData]]` contains a `Record r` such that `r.[[Key]]` is `value`, do
    - i. Set `r.[[Key]]` to empty.
    - ii. Set `r.[[Value]]` to empty.
  - d. For each WeakSet `set` such that `set.[[WeakSetData]]` contains `value`, do
    - i. Replace the element of `set.[[WeakSetData]]` whose value is `value` with an element whose value is empty.

NOTE 1 Together with the definition of liveness, this clause prescribes optimizations that an implementation may apply regarding `WeakRefs`.

It is possible to access an object without observing its identity. Optimizations such as dead variable elimination and scalar replacement on properties of non-escaping objects whose identity is not observed are allowed. These optimizations are thus allowed to observably empty `WeakRefs` that point to such objects.

On the other hand, if an object's identity is observable, and that object is in the `[[WeakRefTarget]]` internal slot of a `WeakRef`, optimizations such as rematerialization that observably empty the `WeakRef` are prohibited.

Because calling `HostEnqueueFinalizationRegistryCleanupJob` is optional, registered objects in a `FinalizationRegistry` do not necessarily hold that `FinalizationRegistry` `live`. Implementations may omit `FinalizationRegistry` callbacks for any reason, e.g., if the `FinalizationRegistry` itself becomes dead, or if the application is shutting down.

NOTE 2 Implementations are not obligated to empty [WeakRefs](#) for maximal sets of non-live objects or symbols.

If an implementation chooses a non-live set *S* in which to empty [WeakRefs](#), this definition requires that it empties [WeakRefs](#) for all values in *S* simultaneously. In other words, it is not conformant for an implementation to empty a [WeakRef](#) pointing to a value *v* without emptying out other [WeakRefs](#) that, if not emptied, could result in an execution that observes the value of *v*.

## 9.10.4 Host Hooks

### 9.10.4.1 HostEnqueueFinalizationRegistryCleanupJob ( *finalizationRegistry* )

The [host-defined](#) abstract operation `HostEnqueueFinalizationRegistryCleanupJob` takes argument *finalizationRegistry* (a [FinalizationRegistry](#)) and returns unused.

Let *cleanupJob* be a new [Job Abstract Closure](#) with no parameters that captures *finalizationRegistry* and performs the following steps when called:

1. Let *cleanupResult* be `Completion(CleanupFinalizationRegistry(finalizationRegistry))`.
2. If *cleanupResult* is an [abrupt completion](#), perform any [host-defined](#) steps for reporting the error.
3. Return unused.

An implementation of `HostEnqueueFinalizationRegistryCleanupJob` schedules *cleanupJob* to be performed at some future time, if possible. It must also conform to the requirements in [9.5](#).

## 9.11 ClearKeptObjects ( )

The abstract operation `ClearKeptObjects` takes no arguments and returns unused. ECMAScript implementations are expected to call `ClearKeptObjects` when a synchronous sequence of ECMAScript executions completes. It performs the following steps when called:

1. Let *agentRecord* be the [surrounding agent's Agent Record](#).
2. Set *agentRecord*.`[[KeptAlive]]` to a new empty [List](#).
3. Return unused.

## 9.12 AddToKeptObjects ( *value* )

The abstract operation `AddToKeptObjects` takes argument *value* (an [Object](#) or a [Symbol](#)) and returns unused. It performs the following steps when called:

1. Let *agentRecord* be the [surrounding agent's Agent Record](#).
2. Append *value* to *agentRecord*.`[[KeptAlive]]`.
3. Return unused.

NOTE When the abstract operation `AddToKeptObjects` is called with a target object or symbol, it adds the target to a list that will point strongly at the target until `ClearKeptObjects` is called.

### 9.13 CleanupFinalizationRegistry ( *finalizationRegistry* )

The abstract operation CleanupFinalizationRegistry takes argument *finalizationRegistry* (a FinalizationRegistry) and returns either a normal completion containing unused or a throw completion. It performs the following steps when called:

1. Assert: *finalizationRegistry* has `[[Cells]]` and `[[CleanupCallback]]` internal slots.
2. Let *callback* be *finalizationRegistry*.`[[CleanupCallback]]`.
3. While *finalizationRegistry*.`[[Cells]]` contains a Record *cell* such that *cell*.`[[WeakRefTarget]]` is empty, an implementation may perform the following steps:
  - a. Choose any such *cell*.
  - b. Remove *cell* from *finalizationRegistry*.`[[Cells]]`.
  - c. Perform ? `HostCallJobCallback(callback, undefined, « cell. [[HeldValue]] »)`.
4. Return unused.

### 9.14 CanBeHeldWeakly ( *v* )

The abstract operation CanBeHeldWeakly takes argument *v* (an ECMAScript language value) and returns a Boolean. It returns **true** if and only if *v* is suitable for use as a weak reference. Only values that are suitable for use as a weak reference may be a key of a WeakMap, an element of a WeakSet, the target of a WeakRef, or one of the targets of a FinalizationRegistry. It performs the following steps when called:

1. If *v* is an Object, return **true**.
2. If *v* is a Symbol and `KeyForSymbol(v)` is **undefined**, return **true**.
3. Return **false**.

**NOTE** A language value without **language identity** can be manifested without prior reference and is unsuitable for use as a weak reference. A Symbol value produced by `Symbol.for`, unlike other Symbol values, does not have language identity and is unsuitable for use as a weak reference. **Well-known symbols** are likely to never be collected, but are nonetheless treated as suitable for use as a weak reference because they are limited in number and therefore manageable by a variety of implementation approaches. However, any value associated to a well-known symbol in a **live** WeakMap is unlikely to be collected and could “leak” memory resources in implementations.

## 10 Ordinary and Exotic Objects Behaviours

### 10.1 Ordinary Object Internal Methods and Internal Slots

All **ordinary objects** have an internal slot called `[[Prototype]]`. The value of this internal slot is either **null** or an object and is used for implementing inheritance. Assume a property named *P* is missing from an **ordinary object** *O* but exists on its `[[Prototype]]` object. If *P* refers to a **data property** on the `[[Prototype]]` object, *O* inherits it for get access, making it behave as if *P* was a property of *O*. If *P* refers to a writable **data property** on the `[[Prototype]]` object, set access of *P* on *O* creates a new **data property** named *P* on *O*. If *P* refers to a non-writable **data property** on the `[[Prototype]]` object, set access of *P* on *O* fails. If *P* refers to an **accessor property** on the `[[Prototype]]` object, the accessor is inherited by *O* for both get access and set access.

Every **ordinary object** has a Boolean-valued `[[Extensible]]` internal slot which is used to fulfill the extensibility-related internal method invariants specified in 6.1.7.3. Namely, once the value of an object's `[[Extensible]]` internal slot has been set to **false**, it is no longer possible to add properties to the object, to modify the value of the object's `[[Prototype]]` internal slot, or to subsequently change the value of `[[Extensible]]` to **true**.

In the following algorithm descriptions, assume *O* is an **ordinary object**, *P* is a **property key** value, *V* is any ECMAScript language value, and *Desc* is a **Property Descriptor** record.

Each **ordinary object** internal method delegates to a similarly-named abstract operation. If such an abstract operation depends on another internal method, then the internal method is invoked on *O* rather than calling the similarly-named abstract operation directly. These semantics ensure that **exotic objects** have their overridden internal methods invoked when **ordinary object** internal methods are applied to them.

### 10.1.1 **[[GetPrototypeOf]] ( )**

The **[[GetPrototypeOf]]** internal method of an **ordinary object** *O* takes no arguments and returns a **normal completion containing** either an Object or **null**. It performs the following steps when called:

1. Return **OrdinaryGetPrototypeOf**(*O*).

#### 10.1.1.1 **OrdinaryGetPrototypeOf ( O )**

The abstract operation **OrdinaryGetPrototypeOf** takes argument *O* (an Object) and returns an Object or **null**. It performs the following steps when called:

1. Return *O*.[[Prototype]].

### 10.1.2 **[[SetPrototypeOf]] ( V )**

The **[[SetPrototypeOf]]** internal method of an **ordinary object** *O* takes argument *V* (an Object or **null**) and returns a **normal completion containing** a Boolean. It performs the following steps when called:

1. Return **OrdinarySetPrototypeOf**(*O*, *V*).

#### 10.1.2.1 **OrdinarySetPrototypeOf ( O, V )**

The abstract operation **OrdinarySetPrototypeOf** takes arguments *O* (an Object) and *V* (an Object or **null**) and returns a Boolean. It performs the following steps when called:

1. Let *current* be *O*.[[Prototype]].
2. If **SameValue**(*V*, *current*) is **true**, return **true**.
3. Let *extensible* be *O*.[[Extensible]].
4. If *extensible* is **false**, return **false**.
5. Let *p* be *V*.
6. Let *done* be **false**.
7. Repeat, while *done* is **false**,
  - a. If *p* is **null**, set *done* to **true**.
  - b. Else if **SameValue**(*p*, *O*) is **true**, return **false**.
  - c. Else,
    - i. If *p*.[[GetPrototypeOf]] is not the **ordinary object** internal method defined in 10.1.1, set *done* to **true**.
    - ii. Else, set *p* to *p*.[[Prototype]].
8. Set *O*.[[Prototype]] to *V*.
9. Return **true**.

NOTE The loop in step 7 guarantees that there will be no circularities in any prototype chain that only includes objects that use the [ordinary object](#) definitions for `[[GetPrototypeOf]]` and `[[SetPrototypeOf]]`.

### 10.1.3 `[[IsExtensible]]` ( )

The `[[IsExtensible]]` internal method of an [ordinary object](#) `O` takes no arguments and returns a [normal completion containing](#) a Boolean. It performs the following steps when called:

1. Return `OrdinaryIsExtensible(O)`.

#### 10.1.3.1 `OrdinaryIsExtensible` ( `O` )

The abstract operation `OrdinaryIsExtensible` takes argument `O` (an Object) and returns a Boolean. It performs the following steps when called:

1. Return `O.[[Extensible]]`.

### 10.1.4 `[[PreventExtensions]]` ( )

The `[[PreventExtensions]]` internal method of an [ordinary object](#) `O` takes no arguments and returns a [normal completion containing](#) `true`. It performs the following steps when called:

1. Return `OrdinaryPreventExtensions(O)`.

#### 10.1.4.1 `OrdinaryPreventExtensions` ( `O` )

The abstract operation `OrdinaryPreventExtensions` takes argument `O` (an Object) and returns `true`. It performs the following steps when called:

1. Set `O.[[Extensible]]` to `false`.
2. Return `true`.

### 10.1.5 `[[GetOwnProperty]]` ( `P` )

The `[[GetOwnProperty]]` internal method of an [ordinary object](#) `O` takes argument `P` (a [property key](#)) and returns a [normal completion containing](#) either a [Property Descriptor](#) or `undefined`. It performs the following steps when called:

1. Return `OrdinaryGetOwnProperty(O, P)`.

#### 10.1.5.1 `OrdinaryGetOwnProperty` ( `O`, `P` )

The abstract operation `OrdinaryGetOwnProperty` takes arguments `O` (an Object) and `P` (a [property key](#)) and returns a [Property Descriptor](#) or `undefined`. It performs the following steps when called:

1. If `O` does not have an own property with key `P`, return `undefined`.
2. Let `D` be a newly created [Property Descriptor](#) with no fields.
3. Let `X` be `O`'s own property whose key is `P`.
4. If `X` is a [data property](#), then

- a. Set  $D.[[Value]]$  to the value of  $X$ 's  $[[Value]]$  attribute.
- b. Set  $D.[[Writable]]$  to the value of  $X$ 's  $[[Writable]]$  attribute.
5. Else,
  - a. Assert:  $X$  is an [accessor property](#).
  - b. Set  $D.[[Get]]$  to the value of  $X$ 's  $[[Get]]$  attribute.
  - c. Set  $D.[[Set]]$  to the value of  $X$ 's  $[[Set]]$  attribute.
6. Set  $D.[[Enumerable]]$  to the value of  $X$ 's  $[[Enumerable]]$  attribute.
7. Set  $D.[[Configurable]]$  to the value of  $X$ 's  $[[Configurable]]$  attribute.
8. Return  $D$ .

### 10.1.6 **[[DefineOwnProperty]]** ( $P$ , $Desc$ )

The **[[DefineOwnProperty]]** internal method of an [ordinary object](#)  $O$  takes arguments  $P$  (a [property key](#)) and  $Desc$  (a [Property Descriptor](#)) and returns either a [normal completion](#) containing a Boolean or a [throw completion](#). It performs the following steps when called:

1. Return ? [OrdinaryDefineOwnProperty](#)( $O$ ,  $P$ ,  $Desc$ ).

#### 10.1.6.1 **OrdinaryDefineOwnProperty** ( $O$ , $P$ , $Desc$ )

The abstract operation [OrdinaryDefineOwnProperty](#) takes arguments  $O$  (an Object),  $P$  (a [property key](#)), and  $Desc$  (a [Property Descriptor](#)) and returns either a [normal completion](#) containing a Boolean or a [throw completion](#). It performs the following steps when called:

1. Let  $current$  be ?  $O.[[GetOwnProperty]](P)$ .
2. Let  $extensible$  be ? [IsExtensible](#)( $O$ ).
3. Return [ValidateAndApplyPropertyDescriptor](#)( $O$ ,  $P$ ,  $extensible$ ,  $Desc$ ,  $current$ ).

#### 10.1.6.2 **IsCompatiblePropertyDescriptor** ( $Extensible$ , $Desc$ , $Current$ )

The abstract operation [IsCompatiblePropertyDescriptor](#) takes arguments  $Extensible$  (a Boolean),  $Desc$  (a [Property Descriptor](#)), and  $Current$  (a [Property Descriptor](#)) and returns a Boolean. It performs the following steps when called:

1. Return [ValidateAndApplyPropertyDescriptor](#)(**undefined**, **""**,  $Extensible$ ,  $Desc$ ,  $Current$ ).

#### 10.1.6.3 **ValidateAndApplyPropertyDescriptor** ( $O$ , $P$ , $extensible$ , $Desc$ , $current$ )

The abstract operation [ValidateAndApplyPropertyDescriptor](#) takes arguments  $O$  (an Object or **undefined**),  $P$  (a [property key](#)),  $extensible$  (a Boolean),  $Desc$  (a [Property Descriptor](#)), and  $current$  (a [Property Descriptor](#) or **undefined**) and returns a Boolean. It returns **true** if and only if  $Desc$  can be applied as the property of an object with specified [extensibility](#) and current property  $current$  while upholding [invariants](#). When such application is possible and  $O$  is not **undefined**, it is performed for the property named  $P$  (which is created if necessary). It performs the following steps when called:

1. **Assert:** `IsPropertyKey(P)` is **true**.
2. If `current` is **undefined**, then
  - a. If `extensible` is **false**, return **false**.
  - b. If `O` is **undefined**, return **true**.
  - c. If `IsAccessorDescriptor(Desc)` is **true**, then
    - i. Create an own **accessor property** named `P` of object `O` whose `[[Get]]`, `[[Set]]`, `[[Enumerable]]`, and `[[Configurable]]` attributes are set to the value of the corresponding field in `Desc` if `Desc` has that field, or to the attribute's **default value** otherwise.
  - d. Else,
    - i. Create an own **data property** named `P` of object `O` whose `[[Value]]`, `[[Writable]]`, `[[Enumerable]]`, and `[[Configurable]]` attributes are set to the value of the corresponding field in `Desc` if `Desc` has that field, or to the attribute's **default value** otherwise.
  - e. Return **true**.
3. **Assert:** `current` is a fully populated Property Descriptor.
4. If `Desc` does not have any fields, return **true**.
5. If `current. [[Configurable]]` is **false**, then
  - a. If `Desc` has a `[[Configurable]]` field and `Desc. [[Configurable]]` is **true**, return **false**.
  - b. If `Desc` has an `[[Enumerable]]` field and `SameValue(Desc. [[Enumerable]], current. [[Enumerable]])` is **false**, return **false**.
  - c. If `IsGenericDescriptor(Desc)` is **false** and `SameValue(IsAccessorDescriptor(Desc), IsAccessorDescriptor(current))` is **false**, return **false**.
  - d. If `IsAccessorDescriptor(current)` is **true**, then
    - i. If `Desc` has a `[[Get]]` field and `SameValue(Desc. [[Get]], current. [[Get]])` is **false**, return **false**.
    - ii. If `Desc` has a `[[Set]]` field and `SameValue(Desc. [[Set]], current. [[Set]])` is **false**, return **false**.
  - e. Else if `current. [[Writable]]` is **false**, then
    - i. If `Desc` has a `[[Writable]]` field and `Desc. [[Writable]]` is **true**, return **false**.
    - ii. If `Desc` has a `[[Value]]` field and `SameValue(Desc. [[Value]], current. [[Value]])` is **false**, return **false**.
6. If `O` is not **undefined**, then
  - a. If `IsDataDescriptor(current)` is **true** and `IsAccessorDescriptor(Desc)` is **true**, then
    - i. If `Desc` has a `[[Configurable]]` field, let `configurable` be `Desc. [[Configurable]]`; else let `configurable` be `current. [[Configurable]]`.
    - ii. If `Desc` has a `[[Enumerable]]` field, let `enumerable` be `Desc. [[Enumerable]]`; else let `enumerable` be `current. [[Enumerable]]`.
    - iii. Replace the property named `P` of object `O` with an **accessor property** whose `[[Configurable]]` and `[[Enumerable]]` attributes are set to `configurable` and `enumerable`, respectively, and whose `[[Get]]` and `[[Set]]` attributes are set to the value of the corresponding field in `Desc` if `Desc` has that field, or to the attribute's **default value** otherwise.
  - b. Else if `IsAccessorDescriptor(current)` is **true** and `IsDataDescriptor(Desc)` is **true**, then
    - i. If `Desc` has a `[[Configurable]]` field, let `configurable` be `Desc. [[Configurable]]`; else let `configurable` be `current. [[Configurable]]`.
    - ii. If `Desc` has a `[[Enumerable]]` field, let `enumerable` be `Desc. [[Enumerable]]`; else let `enumerable` be `current. [[Enumerable]]`.
    - iii. Replace the property named `P` of object `O` with a **data property** whose `[[Configurable]]` and `[[Enumerable]]` attributes are set to `configurable` and `enumerable`, respectively, and whose `[[Value]]` and `[[Writable]]` attributes are set to the value of the corresponding field in `Desc` if `Desc` has that field, or to the attribute's **default value** otherwise.
  - c. Else,

- i. For each field of *Desc*, set the corresponding attribute of the property named *P* of object *O* to the value of the field.

7. Return **true**.

### 10.1.7 **[[HasProperty]]** ( *P* )

The **[[HasProperty]]** internal method of an **ordinary object** *O* takes argument *P* (a **property key**) and returns either a **normal completion containing** a Boolean or a **throw completion**. It performs the following steps when called:

1. Return ? **OrdinaryHasProperty**(*O*, *P*).

#### 10.1.7.1 **OrdinaryHasProperty** ( *O*, *P* )

The abstract operation **OrdinaryHasProperty** takes arguments *O* (an **Object**) and *P* (a **property key**) and returns either a **normal completion containing** a Boolean or a **throw completion**. It performs the following steps when called:

1. Let *hasOwn* be ? *O*.**[[GetOwnProperty]]**(*P*).
2. If *hasOwn* is not **undefined**, return **true**.
3. Let *parent* be ? *O*.**[[GetPrototypeOf]]**(*O*).
4. If *parent* is not **null**, then
  - a. Return ? *parent*.**[[HasProperty]]**(*P*).
5. Return **false**.

### 10.1.8 **[[Get]]** ( *P*, *Receiver* )

The **[[Get]]** internal method of an **ordinary object** *O* takes arguments *P* (a **property key**) and *Receiver* (an **ECMAScript language value**) and returns either a **normal completion containing** an **ECMAScript language value** or a **throw completion**. It performs the following steps when called:

1. Return ? **OrdinaryGet**(*O*, *P*, *Receiver*).

#### 10.1.8.1 **OrdinaryGet** ( *O*, *P*, *Receiver* )

The abstract operation **OrdinaryGet** takes arguments *O* (an **Object**), *P* (a **property key**), and *Receiver* (an **ECMAScript language value**) and returns either a **normal completion containing** an **ECMAScript language value** or a **throw completion**. It performs the following steps when called:

1. Let *desc* be ? *O*.**[[GetOwnProperty]]**(*P*).
2. If *desc* is **undefined**, then
  - a. Let *parent* be ? *O*.**[[GetPrototypeOf]]**(*O*).
  - b. If *parent* is **null**, return **undefined**.
  - c. Return ? *parent*.**[[Get]]**(*P*, *Receiver*).
3. If **IsDataDescriptor**(*desc*) is **true**, return *desc*.**[[Value]]**.
4. **Assert**: **IsAccessorDescriptor**(*desc*) is **true**.
5. Let *getter* be *desc*.**[[Get]]**.
6. If *getter* is **undefined**, return **undefined**.
7. Return ? **Call**(*getter*, *Receiver*).



### 10.1.9 **[[Set]]** ( *P*, *V*, *Receiver* )

The **[[Set]]** internal method of an ordinary object *O* takes arguments *P* (a property key), *V* (an ECMAScript language value), and *Receiver* (an ECMAScript language value) and returns either a normal completion containing a Boolean or a throw completion. It performs the following steps when called:

1. Return ? **OrdinarySet**(*O*, *P*, *V*, *Receiver*).

#### 10.1.9.1 **OrdinarySet** ( *O*, *P*, *V*, *Receiver* )

The abstract operation **OrdinarySet** takes arguments *O* (an Object), *P* (a property key), *V* (an ECMAScript language value), and *Receiver* (an ECMAScript language value) and returns either a normal completion containing a Boolean or a throw completion. It performs the following steps when called:

1. Let *ownDesc* be ? *O*.**[[GetOwnProperty]]**(*P*).
2. Return ? **OrdinarySetWithOwnDescriptor**(*O*, *P*, *V*, *Receiver*, *ownDesc*).

#### 10.1.9.2 **OrdinarySetWithOwnDescriptor** ( *O*, *P*, *V*, *Receiver*, *ownDesc* )

The abstract operation **OrdinarySetWithOwnDescriptor** takes arguments *O* (an Object), *P* (a property key), *V* (an ECMAScript language value), *Receiver* (an ECMAScript language value), and *ownDesc* (a Property Descriptor or **undefined**) and returns either a normal completion containing a Boolean or a throw completion. It performs the following steps when called:

1. If *ownDesc* is **undefined**, then
  - a. Let *parent* be ? *O*.**[[GetPrototypeOf]]**(*O*).
  - b. If *parent* is not **null**, then
    - i. Return ? *parent*.**[[Set]]**(*P*, *V*, *Receiver*).
  - c. Else,
    - i. Set *ownDesc* to the PropertyDescriptor { **[[Value]]**: **undefined**, **[[Writable]]**: **true**, **[[Enumerable]]**: **true**, **[[Configurable]]**: **true** }.
2. If **IsDataDescriptor**(*ownDesc*) is **true**, then
  - a. If *ownDesc*.**[[Writable]]** is **false**, return **false**.
  - b. If *Receiver* is not an Object, return **false**.
  - c. Let *existingDescriptor* be ? *Receiver*.**[[GetOwnProperty]]**(*P*).
  - d. If *existingDescriptor* is not **undefined**, then
    - i. If **IsAccessorDescriptor**(*existingDescriptor*) is **true**, return **false**.
    - ii. If *existingDescriptor*.**[[Writable]]** is **false**, return **false**.
    - iii. Let *valueDesc* be the PropertyDescriptor { **[[Value]]**: *V* }.
    - iv. Return ? *Receiver*.**[[DefineOwnProperty]]**(*P*, *valueDesc*).
  - e. Else,
    - i. **Assert**: *Receiver* does not currently have a property *P*.
    - ii. Return ? **CreateDataProperty**(*Receiver*, *P*, *V*).
3. **Assert**: **IsAccessorDescriptor**(*ownDesc*) is **true**.
4. Let *setter* be *ownDesc*.**[[Set]]**.
5. If *setter* is **undefined**, return **false**.
6. Perform ? **Call**(*setter*, *Receiver*, « *V* »).
7. Return **true**.

### 10.1.10 **[[Delete]] ( *P* )**

The **[[Delete]]** internal method of an **ordinary object** *O* takes argument *P* (a **property key**) and returns either a **normal completion containing** a Boolean or a **throw completion**. It performs the following steps when called:

1. Return ? **OrdinaryDelete**(*O*, *P*).

#### 10.1.10.1 **OrdinaryDelete ( *O*, *P* )**

The abstract operation **OrdinaryDelete** takes arguments *O* (an Object) and *P* (a **property key**) and returns either a **normal completion containing** a Boolean or a **throw completion**. It performs the following steps when called:

1. Let *desc* be ? *O*.**[[GetOwnProperty]]**(*P*).
2. If *desc* is **undefined**, return **true**.
3. If *desc*.**[[Configurable]]** is **true**, then
  - a. Remove the own property with name *P* from *O*.
  - b. Return **true**.
4. Return **false**.

### 10.1.11 **[[OwnPropertyKeys]] ( )**

The **[[OwnPropertyKeys]]** internal method of an **ordinary object** *O* takes no arguments and returns a **normal completion containing** a **List** of **property keys**. It performs the following steps when called:

1. Return **OrdinaryOwnPropertyKeys**(*O*).

#### 10.1.11.1 **OrdinaryOwnPropertyKeys ( *O* )**

The abstract operation **OrdinaryOwnPropertyKeys** takes argument *O* (an Object) and returns a **List** of **property keys**. It performs the following steps when called:

1. Let *keys* be a new empty **List**.
2. For each own **property key** *P* of *O* such that *P* is an **array index**, in ascending numeric index order, do
  - a. Append *P* to *keys*.
3. For each own **property key** *P* of *O* such that *P* is a **String** and *P* is not an **array index**, in ascending chronological order of property creation, do
  - a. Append *P* to *keys*.
4. For each own **property key** *P* of *O* such that *P* is a **Symbol**, in ascending chronological order of property creation, do
  - a. Append *P* to *keys*.
5. Return *keys*.

### 10.1.12 **OrdinaryObjectCreate ( *proto* [ , *additionalInternalSlotsList* ] )**

The abstract operation **OrdinaryObjectCreate** takes argument *proto* (an Object or **null**) and optional argument *additionalInternalSlotsList* (a **List** of names of internal slots) and returns an Object. It is used to specify the runtime creation of new **ordinary objects**. *additionalInternalSlotsList* contains the names of additional internal slots that must be defined as part of the object, beyond **[[Prototype]]** and **[[Extensible]]**. If *additionalInternalSlotsList* is not provided, a new empty **List** is used. It performs the following steps when called:

1. Let *internalSlotsList* be « [[Prototype]], [[Extensible]] ».
2. If *additionalInternalSlotsList* is present, set *internalSlotsList* to the list-concatenation of *internalSlotsList* and *additionalInternalSlotsList*.
3. Let *O* be `MakeBasicObject(internalSlotsList)`.
4. Set *O*.[[Prototype]] to *proto*.
5. Return *O*.

**NOTE** Although `OrdinaryObjectCreate` does little more than call `MakeBasicObject`, its use communicates the intention to create an **ordinary object**, and not an exotic one. Thus, within this specification, it is not called by any algorithm that subsequently modifies the internal methods of the object in ways that would make the result non-ordinary. Operations that create **exotic objects** invoke `MakeBasicObject` directly.

### 10.1.13 OrdinaryCreateFromConstructor ( *constructor*, *intrinsicDefaultProto* [ , *internalSlotsList* ] )

The abstract operation `OrdinaryCreateFromConstructor` takes arguments *constructor* (a **constructor**) and *intrinsicDefaultProto* (a String) and optional argument *internalSlotsList* (a List of names of internal slots) and returns either a **normal completion containing** an Object or a **throw completion**. It creates an **ordinary object** whose [[Prototype]] value is retrieved from a **constructor's "prototype"** property, if it exists. Otherwise the intrinsic named by *intrinsicDefaultProto* is used for [[Prototype]]. *internalSlotsList* contains the names of additional internal slots that must be defined as part of the object. If *internalSlotsList* is not provided, a new empty List is used. It performs the following steps when called:

1. **Assert:** *intrinsicDefaultProto* is this specification's name of an intrinsic object. The corresponding object must be an intrinsic that is intended to be used as the [[Prototype]] value of an object.
2. Let *proto* be ? `GetPrototypeFromConstructor(constructor, intrinsicDefaultProto)`.
3. If *internalSlotsList* is present, let *slotsList* be *internalSlotsList*.
4. Else, let *slotsList* be a new empty List.
5. Return `OrdinaryObjectCreate(proto, slotsList)`.

### 10.1.14 GetPrototypeFromConstructor ( *constructor*, *intrinsicDefaultProto* )

The abstract operation `GetPrototypeFromConstructor` takes arguments *constructor* (a **function object**) and *intrinsicDefaultProto* (a String) and returns either a **normal completion containing** an Object or a **throw completion**. It determines the [[Prototype]] value that should be used to create an object corresponding to a specific **constructor**. The value is retrieved from the **constructor's "prototype"** property, if it exists. Otherwise the intrinsic named by *intrinsicDefaultProto* is used for [[Prototype]]. It performs the following steps when called:

1. **Assert:** *intrinsicDefaultProto* is this specification's name of an intrinsic object. The corresponding object must be an intrinsic that is intended to be used as the [[Prototype]] value of an object.
2. Let *proto* be ? `Get(constructor, "prototype")`.
3. If *proto* is not an Object, then
  - a. Let *realm* be ? `GetFunctionRealm(constructor)`.
  - b. Set *proto* to *realm*'s intrinsic object named *intrinsicDefaultProto*.
4. Return *proto*.

**NOTE** If *constructor* does not supply a [[Prototype]] value, the default value that is used is obtained from the **realm** of the *constructor* function rather than from the **running execution context**.

### 10.1.15 RequireInternalSlot ( *O*, *internalSlot* )

The abstract operation `RequireInternalSlot` takes arguments *O* (an [ECMAScript language value](#)) and *internalSlot* (an internal slot name) and returns either a [normal completion containing unused](#) or a [throw completion](#). It throws an exception unless *O* is an [Object](#) and has the given internal slot. It performs the following steps when called:

1. If *O* is not an [Object](#), throw a **TypeError** exception.
2. If *O* does not have an *internalSlot* internal slot, throw a **TypeError** exception.
3. Return unused.

## 10.2 ECMAScript Function Objects

ECMAScript [function objects](#) encapsulate parameterized ECMAScript code closed over a lexical environment and support the dynamic evaluation of that code. An ECMAScript [function object](#) is an [ordinary object](#) and has the same internal slots and the same internal methods as other [ordinary objects](#). The code of an ECMAScript [function object](#) may be either [strict mode code](#) (11.2.2) or [non-strict code](#). An ECMAScript [function object](#) whose code is [strict mode code](#) is called a *strict function*. One whose code is not [strict mode code](#) is called a *non-strict function*.

In addition to `[[Extensible]]` and `[[Prototype]]`, ECMAScript [function objects](#) also have the internal slots listed in [Table 30](#).

Table 30: Internal Slots of ECMAScript Function Objects

Internal Slot	Type	Description
<code>[[Environment]]</code>	an <a href="#">Environment Record</a>	The <a href="#">Environment Record</a> that the function was closed over. Used as the outer environment when evaluating the code of the function.
<code>[[PrivateEnvironment]]</code>	a <a href="#">PrivateEnvironment Record</a> or <b>null</b>	The <a href="#">PrivateEnvironment Record</a> for <a href="#">Private Names</a> that the function was closed over. <b>null</b> if this function is not syntactically contained within a class. Used as the outer <code>PrivateEnvironment</code> for inner classes when evaluating the code of the function.
<code>[[FormalParameters]]</code>	a <a href="#">Parse Node</a>	The root parse node of the source text that defines the function's formal parameter list.
<code>[[ECMAScriptCode]]</code>	a <a href="#">Parse Node</a>	The root parse node of the source text that defines the function's body.
<code>[[ConstructorKind]]</code>	base or derived	Whether or not the function is a derived class <a href="#">constructor</a> .
<code>[[Realm]]</code>	a <a href="#">Realm Record</a>	The <a href="#">realm</a> in which the function was created and which provides any intrinsic objects that are accessed when evaluating the function.
<code>[[ScriptOrModule]]</code>	a <a href="#">Script Record</a> or a <a href="#">Module Record</a>	The script or module in which the function was created.
<code>[[ThisMode]]</code>	lexical, strict, or global	Defines how <b>this</b> references are interpreted within the formal parameters and code body of the function. lexical means that <b>this</b> refers to the <b>this</b> value of a lexically enclosing function. strict means that the <b>this</b> value is used exactly as provided by an invocation of the function. global means that a <b>this</b> value of <b>undefined</b> or <b>null</b> is interpreted as a reference to the <a href="#">global object</a> , and any other <b>this</b> value is first passed to <a href="#">ToObject</a> .

Table 30 (continued)

Internal Slot	Type	Description
[[Strict]]	a Boolean	<b>true</b> if this is a <b>strict function</b> , <b>false</b> if this is a <b>non-strict function</b> .
[[HomeObject]]	an Object	If the function uses <b>super</b> , this is the object whose [[GetPrototypeOf]] provides the object where <b>super</b> property lookups begin.
[[SourceText]]	a sequence of Unicode code points	The <b>source text</b> that defines the function.
[[Fields]]	a List of <b>ClassFieldDefinition</b> <b>Records</b>	If the function is a class, this is a list of <b>Records</b> representing the non-static fields and corresponding initializers of the class.
[[PrivateMethods]]	a List of <b>PrivateElements</b>	If the function is a class, this is a list representing the non-static private methods and accessors of the class.
[[ClassFieldInitializerName]]	a String, a Symbol, a <b>Private Name</b> , or empty	If the function is created as the initializer of a class field, the name to use for <b>NamedEvaluation</b> of the field; empty otherwise.
[[IsClassConstructor]]	a Boolean	Indicates whether the function is a class <b>constructor</b> . (If <b>true</b> , invoking the function's [[Call]] will immediately throw a <b>TypeError</b> exception.)

All ECMAScript **function objects** have the [[Call]] internal method defined here. ECMAScript functions that are also **constructors** in addition have the [[Construct]] internal method.

### 10.2.1 [[Call]] ( *thisArgument*, *argumentsList* )

The [[Call]] internal method of an ECMAScript **function object** *F* takes arguments *thisArgument* (an ECMAScript language value) and *argumentsList* (a List of ECMAScript language values) and returns either a **normal completion** containing an ECMAScript language value or a **throw completion**. It performs the following steps when called:

1. Let *callerContext* be the **running execution context**.
2. Let *calleeContext* be **PrepareForOrdinaryCall**(*F*, **undefined**).
3. **Assert**: *calleeContext* is now the **running execution context**.
4. If *F*.[[IsClassConstructor]] is **true**, then
  - a. Let *error* be a newly created **TypeError** object.
  - b. NOTE: *error* is created in *calleeContext* with *F*'s associated **Realm Record**.
  - c. Remove *calleeContext* from the **execution context stack** and restore *callerContext* as the **running execution context**.
  - d. Return **ThrowCompletion**(*error*).
5. Perform **OrdinaryCallBindThis**(*F*, *calleeContext*, *thisArgument*).
6. Let *result* be **Completion**(**OrdinaryCallEvaluateBody**(*F*, *argumentsList*)).
7. Remove *calleeContext* from the **execution context stack** and restore *callerContext* as the **running execution context**.
8. If *result*.[[Type]] is **return**, return *result*.[[Value]].
9. **ReturnIfAbrupt**(*result*).
10. Return **undefined**.

**NOTE** When *calleeContext* is removed from the *execution context stack* in step 7 it must not be destroyed if it is suspended and retained for later resumption by an accessible Generator.

### 10.2.1.1 PrepareForOrdinaryCall ( *F*, *newTarget* )

The abstract operation PrepareForOrdinaryCall takes arguments *F* (a *function object*) and *newTarget* (an Object or **undefined**) and returns an *execution context*. It performs the following steps when called:

1. Let *callerContext* be the *running execution context*.
2. Let *calleeContext* be a new *ECMAScript code execution context*.
3. Set the Function of *calleeContext* to *F*.
4. Let *calleeRealm* be *F*.[[*Realm*]].
5. Set the *Realm* of *calleeContext* to *calleeRealm*.
6. Set the ScriptOrModule of *calleeContext* to *F*.[[*ScriptOrModule*]].
7. Let *localEnv* be *NewFunctionEnvironment*(*F*, *newTarget*).
8. Set the *LexicalEnvironment* of *calleeContext* to *localEnv*.
9. Set the *VariableEnvironment* of *calleeContext* to *localEnv*.
10. Set the *PrivateEnvironment* of *calleeContext* to *F*.[[*PrivateEnvironment*]].
11. If *callerContext* is not already suspended, suspend *callerContext*.
12. Push *calleeContext* onto the *execution context stack*; *calleeContext* is now the *running execution context*.
13. NOTE: Any exception objects produced after this point are associated with *calleeRealm*.
14. Return *calleeContext*.

### 10.2.1.2 OrdinaryCallBindThis ( *F*, *calleeContext*, *thisArgument* )

The abstract operation OrdinaryCallBindThis takes arguments *F* (a *function object*), *calleeContext* (an *execution context*), and *thisArgument* (an *ECMAScript language value*) and returns unused. It performs the following steps when called:

1. Let *thisMode* be *F*.[[*ThisMode*]].
2. If *thisMode* is lexical, return unused.
3. Let *calleeRealm* be *F*.[[*Realm*]].
4. Let *localEnv* be the *LexicalEnvironment* of *calleeContext*.
5. If *thisMode* is strict, let *thisValue* be *thisArgument*.
6. Else,
  - a. If *thisArgument* is either **undefined** or **null**, then
    - i. Let *globalEnv* be *calleeRealm*.[[*GlobalEnv*]].
    - ii. **Assert**: *globalEnv* is a *Global Environment Record*.
    - iii. Let *thisValue* be *globalEnv*.[[*GlobalThisValue*]].
  - b. Else,
    - i. Let *thisValue* be ! *ToObject*(*thisArgument*).
    - ii. NOTE: *ToObject* produces wrapper objects using *calleeRealm*.
7. **Assert**: *localEnv* is a *Function Environment Record*.
8. **Assert**: The next step never returns an *abrupt completion* because *localEnv*.[[*ThisBindingStatus*]] is not initialized.
9. Perform ! *localEnv*.*BindThisValue*(*thisValue*).
10. Return unused.

### 10.2.1.3 Runtime Semantics: EvaluateBody

The [syntax-directed operation](#) EvaluateBody takes arguments [functionObject](#) (a [function object](#)) and [argumentsList](#) (a [List of ECMAScript language values](#)) and returns either a [normal completion containing an ECMAScript language value](#) or an [abrupt completion](#). It is defined piecewise over the following productions:

*FunctionBody* : *FunctionStatementList*

1. Return ? [EvaluateFunctionBody](#) of *FunctionBody* with arguments [functionObject](#) and [argumentsList](#).

*ConciseBody* : *ExpressionBody*

1. Return ? [EvaluateConciseBody](#) of *ConciseBody* with arguments [functionObject](#) and [argumentsList](#).

*GeneratorBody* : *FunctionBody*

1. Return ? [EvaluateGeneratorBody](#) of *GeneratorBody* with arguments [functionObject](#) and [argumentsList](#).

*AsyncGeneratorBody* : *FunctionBody*

1. Return ? [EvaluateAsyncGeneratorBody](#) of *AsyncGeneratorBody* with arguments [functionObject](#) and [argumentsList](#).

*AsyncFunctionBody* : *FunctionBody*

1. Return ? [EvaluateAsyncFunctionBody](#) of *AsyncFunctionBody* with arguments [functionObject](#) and [argumentsList](#).

*AsyncConciseBody* : *ExpressionBody*

1. Return ? [EvaluateAsyncConciseBody](#) of *AsyncConciseBody* with arguments [functionObject](#) and [argumentsList](#).

*Initializer* :

= *AssignmentExpression*

1. [Assert](#): [argumentsList](#) is empty.
2. [Assert](#): [functionObject](#).[[ClassFieldInitializerName]] is not empty.
3. If [IsAnonymousFunctionDefinition](#)(*AssignmentExpression*) is **true**, then
  - a. Let *value* be ? [NamedEvaluation](#) of *Initializer* with argument [functionObject](#).  
[[ClassFieldInitializerName]].
4. Else,
  - a. Let *rhs* be ? [Evaluation](#) of *AssignmentExpression*.
  - b. Let *value* be ? [GetValue](#)(*rhs*).
5. Return [Completion Record](#) { [[Type]]: return, [[Value]]: *value*, [[Target]]: empty }.

**NOTE** Even though field initializers constitute a function boundary, calling [FunctionDeclarationInstantiation](#) does not have any observable effect and so is omitted.

*ClassStaticBlockBody* : *ClassStaticBlockStatementList*

1. [Assert](#): [argumentsList](#) is empty.
2. Return ? [EvaluateClassStaticBlockBody](#) of *ClassStaticBlockBody* with argument [functionObject](#).

#### 10.2.1.4 OrdinaryCallEvaluateBody ( *F*, *argumentsList* )

The abstract operation OrdinaryCallEvaluateBody takes arguments *F* (a function object) and *argumentsList* (a List of ECMAScript language values) and returns either a normal completion containing an ECMAScript language value or an abrupt completion. It performs the following steps when called:

1. Return ? EvaluateBody of *F*.[[ECMAScriptCode]] with arguments *F* and *argumentsList*.

#### 10.2.2 [[Construct]] ( *argumentsList*, *newTarget* )

The [[Construct]] internal method of an ECMAScript function object *F* takes arguments *argumentsList* (a List of ECMAScript language values) and *newTarget* (a constructor) and returns either a normal completion containing an Object or a throw completion. It performs the following steps when called:

1. Let *callerContext* be the running execution context.
2. Let *kind* be *F*.[[ConstructorKind]].
3. If *kind* is base, then
  - a. Let *thisArgument* be ? OrdinaryCreateFromConstructor(*newTarget*, "%Object.prototype%").
4. Let *calleeContext* be PrepareForOrdinaryCall(*F*, *newTarget*).
5. Assert: *calleeContext* is now the running execution context.
6. If *kind* is base, then
  - a. Perform OrdinaryCallBindThis(*F*, *calleeContext*, *thisArgument*).
  - b. Let *initializeResult* be Completion(InitializeInstanceElements(*thisArgument*, *F*)).
  - c. If *initializeResult* is an abrupt completion, then
    - i. Remove *calleeContext* from the execution context stack and restore *callerContext* as the running execution context.
    - ii. Return ? *initializeResult*.
7. Let *constructorEnv* be the LexicalEnvironment of *calleeContext*.
8. Let *result* be Completion(OrdinaryCallEvaluateBody(*F*, *argumentsList*)).
9. Remove *calleeContext* from the execution context stack and restore *callerContext* as the running execution context.
10. If *result*.[[Type]] is return, then
  - a. If *result*.[[Value]] is an Object, return *result*.[[Value]].
  - b. If *kind* is base, return *thisArgument*.
  - c. If *result*.[[Value]] is not **undefined**, throw a **TypeError** exception.
11. Else, ReturnIfAbrupt(*result*).
12. Let *thisBinding* be ? *constructorEnv*.GetThisBinding().
13. Assert: *thisBinding* is an Object.
14. Return *thisBinding*.

#### 10.2.3 OrdinaryFunctionCreate ( *functionPrototype*, *sourceText*, *ParameterList*, *Body*, *thisMode*, *env*, *privateEnv* )

The abstract operation OrdinaryFunctionCreate takes arguments *functionPrototype* (an Object), *sourceText* (a sequence of Unicode code points), *ParameterList* (a Parse Node), *Body* (a Parse Node), *thisMode* (lexical-this or non-lexical-this), *env* (an Environment Record), and *privateEnv* (a PrivateEnvironment Record or null) and returns a function object. It is used to specify the runtime creation of a new function with a default [[Call]] internal method and no [[Construct]] internal method (although one may be subsequently added by an operation such as MakeConstructor). *sourceText* is the source text of the syntactic definition of the function to be created. It performs the following steps when called:

1. Let *internalSlotsList* be the internal slots listed in Table 30.



2. Let *F* be `OrdinaryObjectCreate(functionPrototype, internalSlotsList)`.
3. Set *F*.[[Call]] to the definition specified in 10.2.1.
4. Set *F*.[[SourceText]] to *sourceText*.
5. Set *F*.[[FormalParameters]] to *ParameterList*.
6. Set *F*.[[ECMAScriptCode]] to *Body*.
7. If the *source text* matched by *Body* is strict mode code, let *Strict* be **true**; else let *Strict* be **false**.
8. Set *F*.[[Strict]] to *Strict*.
9. If *thisMode* is lexical-this, set *F*.[[ThisMode]] to lexical.
10. Else if *Strict* is **true**, set *F*.[[ThisMode]] to strict.
11. Else, set *F*.[[ThisMode]] to global.
12. Set *F*.[[IsClassConstructor]] to **false**.
13. Set *F*.[[Environment]] to *env*.
14. Set *F*.[[PrivateEnvironment]] to *privateEnv*.
15. Set *F*.[[ScriptOrModule]] to `GetActiveScriptOrModule()`.
16. Set *F*.[[Realm]] to the current Realm Record.
17. Set *F*.[[HomeObject]] to **undefined**.
18. Set *F*.[[Fields]] to a new empty List.
19. Set *F*.[[PrivateMethods]] to a new empty List.
20. Set *F*.[[ClassFieldInitializerName]] to empty.
21. Let *len* be the `ExpectedArgumentCount` of *ParameterList*.
22. Perform `SetFunctionLength(F, len)`.
23. Return *F*.

#### 10.2.4 AddRestrictedFunctionProperties ( *F*, *realm* )

The abstract operation `AddRestrictedFunctionProperties` takes arguments *F* (a function object) and *realm* (a Realm Record) and returns unused. It performs the following steps when called:

1. Assert: *realm*.[[Intrinsics]].[[%ThrowTypeError%]] exists and has been initialized.
2. Let *thrower* be *realm*.[[Intrinsics]].[[%ThrowTypeError%]].
3. Perform ! `DefinePropertyOrThrow(F, "caller", PropertyDescriptor { [[Get]]: thrower, [[Set]]: thrower, [[Enumerable]]: false, [[Configurable]]: true }`.
4. Perform ! `DefinePropertyOrThrow(F, "arguments", PropertyDescriptor { [[Get]]: thrower, [[Set]]: thrower, [[Enumerable]]: false, [[Configurable]]: true }`.
5. Return unused.

##### 10.2.4.1 %ThrowTypeError% ( )

This function is the `%ThrowTypeError%` intrinsic object.

It is an anonymous built-in function object that is defined once for each *realm*.

It performs the following steps when called:

1. Throw a **TypeError** exception.

The value of the [[Extensible]] internal slot of this function is **false**.

The **"length"** property of this function has the attributes { [[Writable]]: **false**, [[Enumerable]]: **false**, [[Configurable]]: **false** }.

The "name" property of this function has the attributes { `[[Writable]]`: **false**, `[[Enumerable]]`: **false**, `[[Configurable]]`: **false** }.

### 10.2.5 MakeConstructor ( *F* [ , *writablePrototype* [ , *prototype* ] ] )

The abstract operation MakeConstructor takes argument *F* (an ECMAScript [function object](#) or a built-in [function object](#)) and optional arguments *writablePrototype* (a Boolean) and *prototype* (an Object) and returns unused. It converts *F* into a [constructor](#). It performs the following steps when called:

1. If *F* is an ECMAScript [function object](#), then
  - a. **Assert**: `IsConstructor(F)` is **false**.
  - b. **Assert**: *F* is an extensible object that does not have a "prototype" own property.
  - c. Set *F*.`[[Construct]]` to the definition specified in [10.2.2](#).
2. Else,
  - a. Set *F*.`[[Construct]]` to the definition specified in [10.3.2](#).
3. Set *F*.`[[ConstructorKind]]` to base.
4. If *writablePrototype* is not present, set *writablePrototype* to **true**.
5. If *prototype* is not present, then
  - a. Set *prototype* to `OrdinaryObjectCreate(%Object.prototype%)`.
  - b. Perform ! `DefinePropertyOrThrow(prototype, "constructor", PropertyDescriptor { [[Value]]: F, [[Writable]]: writablePrototype, [[Enumerable]]: false, [[Configurable]]: true })`.
6. Perform ! `DefinePropertyOrThrow(F, "prototype", PropertyDescriptor { [[Value]]: prototype, [[Writable]]: writablePrototype, [[Enumerable]]: false, [[Configurable]]: false })`.
7. Return unused.

### 10.2.6 MakeClassConstructor ( *F* )

The abstract operation MakeClassConstructor takes argument *F* (an ECMAScript [function object](#)) and returns unused. It performs the following steps when called:

1. **Assert**: *F*.`[[IsClassConstructor]]` is **false**.
2. Set *F*.`[[IsClassConstructor]]` to **true**.
3. Return unused.

### 10.2.7 MakeMethod ( *F*, *homeObject* )

The abstract operation MakeMethod takes arguments *F* (an ECMAScript [function object](#)) and *homeObject* (an Object) and returns unused. It configures *F* as a method. It performs the following steps when called:

1. Set *F*.`[[HomeObject]]` to *homeObject*.
2. Return unused.

### 10.2.8 DefineMethodProperty ( *homeObject*, *key*, *closure*, *enumerable* )

The abstract operation DefineMethodProperty takes arguments *homeObject* (an Object), *key* (a [property key](#) or [Private Name](#)), *closure* (a [function object](#)), and *enumerable* (a Boolean) and returns a [PrivateElement](#) or unused. It performs the following steps when called:

1. **Assert**: *homeObject* is an ordinary, extensible object with no non-configurable properties.
2. If *key* is a [Private Name](#), then
  - a. Return `PrivateElement { [[Key]]: key, [[Kind]]: method, [[Value]]: closure }`.

3. Else,
  - a. Let *desc* be the PropertyDescriptor { [[Value]]: *closure*, [[Writable]]: **true**, [[Enumerable]]: *enumerable*, [[Configurable]]: **true** }.
  - b. Perform ! **DefinePropertyOrThrow**(*homeObject*, *key*, *desc*).
  - c. Return unused.

### 10.2.9 SetFunctionName ( *F*, *name* [ , *prefix* ] )

The abstract operation SetFunctionName takes arguments *F* (a function object) and *name* (a property key or Private Name) and optional argument *prefix* (a String) and returns unused. It adds a "name" property to *F*. It performs the following steps when called:

1. **Assert**: *F* is an extensible object that does not have a "name" own property.
2. If *name* is a Symbol, then
  - a. Let *description* be *name*'s [[Description]] value.
  - b. If *description* is **undefined**, set *name* to the empty String.
  - c. Else, set *name* to the string-concatenation of "[", *description*, and "]"
3. Else if *name* is a Private Name, then
  - a. Set *name* to *name*.[[Description]].
4. If *F* has an [[InitialName]] internal slot, then
  - a. Set *F*.[[InitialName]] to *name*.
5. If *prefix* is present, then
  - a. Set *name* to the string-concatenation of *prefix*, the code unit 0x0020 (SPACE), and *name*.
  - b. If *F* has an [[InitialName]] internal slot, then
    - i. Optionally, set *F*.[[InitialName]] to *name*.
6. Perform ! **DefinePropertyOrThrow**(*F*, "name", PropertyDescriptor { [[Value]]: *name*, [[Writable]]: **false**, [[Enumerable]]: **false**, [[Configurable]]: **true** }).
7. Return unused.

### 10.2.10 SetFunctionLength ( *F*, *length* )

The abstract operation SetFunctionLength takes arguments *F* (a function object) and *length* (a non-negative integer or +∞) and returns unused. It adds a "length" property to *F*. It performs the following steps when called:

1. **Assert**: *F* is an extensible object that does not have a "length" own property.
2. Perform ! **DefinePropertyOrThrow**(*F*, "length", PropertyDescriptor { [[Value]]:  $\mathbb{F}(\textit{length})$ , [[Writable]]: **false**, [[Enumerable]]: **false**, [[Configurable]]: **true** }).
3. Return unused.

### 10.2.11 FunctionDeclarationInstantiation ( *func*, *argumentsList* )

The abstract operation FunctionDeclarationInstantiation takes arguments *func* (a function object) and *argumentsList* (a List of ECMAScript language values) and returns either a normal completion containing unused or an abrupt completion. *func* is the function object for which the execution context is being established.

NOTE 1 When an [execution context](#) is established for evaluating an ECMAScript function a new [Function Environment Record](#) is created and bindings for each formal parameter are instantiated in that [Environment Record](#). Each declaration in the function body is also instantiated. If the function's formal parameters do not include any default value initializers then the body declarations are instantiated in the same [Environment Record](#) as the parameters. If default value parameter initializers exist, a second [Environment Record](#) is created for the body declarations. Formal parameters and functions are initialized as part of [FunctionDeclarationInstantiation](#). All other bindings are initialized during evaluation of the function body.

It performs the following steps when called:

1. Let *calleeContext* be the [running execution context](#).
2. Let *code* be *func*.[[ECMAScriptCode]].
3. Let *strict* be *func*.[[Strict]].
4. Let *formals* be *func*.[[FormalParameters]].
5. Let *parameterNames* be the [BoundNames](#) of *formals*.
6. If *parameterNames* has any duplicate entries, let *hasDuplicates* be **true**. Otherwise, let *hasDuplicates* be **false**.
7. Let *simpleParameterList* be [IsSimpleParameterList](#) of *formals*.
8. Let *hasParameterExpressions* be [ContainsExpression](#) of *formals*.
9. Let *varNames* be the [VarDeclaredNames](#) of *code*.
10. Let *varDeclarations* be the [VarScopedDeclarations](#) of *code*.
11. Let *lexicalNames* be the [LexicallyDeclaredNames](#) of *code*.
12. Let *functionNames* be a new empty [List](#).
13. Let *functionsToInitialize* be a new empty [List](#).
14. For each element *d* of *varDeclarations*, in reverse [List](#) order, do
  - a. If *d* is neither a [VariableDeclaration](#) nor a [ForBinding](#) nor a [BindingIdentifier](#), then
    - i. **Assert**: *d* is either a [FunctionDeclaration](#), a [GeneratorDeclaration](#), an [AsyncFunctionDeclaration](#), or an [AsyncGeneratorDeclaration](#).
    - ii. Let *fn* be the sole element of the [BoundNames](#) of *d*.
    - iii. If *functionNames* does not contain *fn*, then
      1. Insert *fn* as the first element of *functionNames*.
      2. NOTE: If there are multiple function declarations for the same name, the last declaration is used.
      3. Insert *d* as the first element of *functionsToInitialize*.
15. Let *argumentsObjectNeeded* be **true**.
16. If *func*.[[ThisMode]] is lexical, then
  - a. NOTE: Arrow functions never have an arguments object.
  - b. Set *argumentsObjectNeeded* to **false**.
17. Else if *parameterNames* contains "arguments", then
  - a. Set *argumentsObjectNeeded* to **false**.
18. Else if *hasParameterExpressions* is **false**, then
  - a. If *functionNames* contains "arguments" or *lexicalNames* contains "arguments", then
    - i. Set *argumentsObjectNeeded* to **false**.
19. If *strict* is **true** or *hasParameterExpressions* is **false**, then
  - a. NOTE: Only a single [Environment Record](#) is needed for the parameters, since calls to **eval** in [strict mode code](#) cannot create new bindings which are visible outside of the **eval**.
  - b. Let *env* be the [LexicalEnvironment](#) of *calleeContext*.
20. Else,

- a. NOTE: A separate **Environment Record** is needed to ensure that bindings created by **direct eval** calls in the formal parameter list are outside the environment where parameters are declared.
  - b. Let *calleeEnv* be the **LexicalEnvironment** of *calleeContext*.
  - c. Let *env* be **NewDeclarativeEnvironment**(*calleeEnv*).
  - d. **Assert**: The **VariableEnvironment** of *calleeContext* is *calleeEnv*.
  - e. Set the **LexicalEnvironment** of *calleeContext* to *env*.
21. For each String *paramName* of *parameterNames*, do
- a. Let *alreadyDeclared* be ! *env*.**HasBinding**(*paramName*).
  - b. NOTE: **Early errors** ensure that duplicate parameter names can only occur in **non-strict functions** that do not have parameter default values or rest parameters.
  - c. If *alreadyDeclared* is **false**, then
    - i. Perform ! *env*.**CreateMutableBinding**(*paramName*, **false**).
    - ii. If *hasDuplicates* is **true**, then
      - 1. Perform ! *env*.**InitializeBinding**(*paramName*, **undefined**).
22. If *argumentsObjectNeeded* is **true**, then
- a. If *strict* is **true** or *simpleParameterList* is **false**, then
    - i. Let *ao* be **CreateUnmappedArgumentsObject**(*argumentsList*).
  - b. Else,
    - i. NOTE: A mapped argument object is only provided for **non-strict functions** that don't have a rest parameter, any parameter default value initializers, or any destructured parameters.
    - ii. Let *ao* be **CreateMappedArgumentsObject**(*func*, *formals*, *argumentsList*, *env*).
  - c. If *strict* is **true**, then
    - i. Perform ! *env*.**CreateImmutableBinding**("arguments", **false**).
    - ii. NOTE: In **strict mode code early errors** prevent attempting to assign to this binding, so its mutability is not observable.
  - d. Else,
    - i. Perform ! *env*.**CreateMutableBinding**("arguments", **false**).
  - e. Perform ! *env*.**InitializeBinding**("arguments", *ao*).
  - f. Let *parameterBindings* be the **list-concatenation** of *parameterNames* and « "arguments" ».
23. Else,
- a. Let *parameterBindings* be *parameterNames*.
24. Let *iteratorRecord* be **CreateListIteratorRecord**(*argumentsList*).
25. If *hasDuplicates* is **true**, then
- a. Perform ? **IteratorBindingInitialization** of *formals* with arguments *iteratorRecord* and **undefined**.
26. Else,
- a. Perform ? **IteratorBindingInitialization** of *formals* with arguments *iteratorRecord* and *env*.
27. If *hasParameterExpressions* is **false**, then
- a. NOTE: Only a single **Environment Record** is needed for the parameters and top-level vars.
  - b. Let *instantiatedVarNames* be a copy of the **List** *parameterBindings*.
  - c. For each element *n* of *varNames*, do
    - i. If *instantiatedVarNames* does not contain *n*, then
      - 1. Append *n* to *instantiatedVarNames*.
      - 2. Perform ! *env*.**CreateMutableBinding**(*n*, **false**).
      - 3. Perform ! *env*.**InitializeBinding**(*n*, **undefined**).
  - d. Let *varEnv* be *env*.
28. Else,
- a. NOTE: A separate **Environment Record** is needed to ensure that closures created by expressions in the formal parameter list do not have visibility of declarations in the function

- body.
- b. Let *varEnv* be `NewDeclarativeEnvironment(env)`.
  - c. Set the VariableEnvironment of *calleeContext* to *varEnv*.
  - d. Let *instantiatedVarNames* be a new empty List.
  - e. For each element *n* of *varNames*, do
    - i. If *instantiatedVarNames* does not contain *n*, then
      1. Append *n* to *instantiatedVarNames*.
      2. Perform ! *varEnv*.CreateMutableBinding(*n*, **false**).
      3. If *parameterBindings* does not contain *n*, or if *functionNames* contains *n*, let *initialValue* be **undefined**.
      4. Else,
        - a. Let *initialValue* be ! *env*.GetBindingValue(*n*, **false**).
      5. Perform ! *varEnv*.InitializeBinding(*n*, *initialValue*).
      6. NOTE: A var with the same name as a formal parameter initially has the same value as the corresponding initialized parameter.
29. NOTE: Annex B.3.2.1 adds additional steps at this point.
30. If *strict* is **false**, then
- a. Let *lexEnv* be `NewDeclarativeEnvironment(varEnv)`.
  - b. NOTE: Non-strict functions use a separate Environment Record for top-level lexical declarations so that a direct eval can determine whether any var scoped declarations introduced by the eval code conflict with pre-existing top-level lexically scoped declarations. This is not needed for strict functions because a strict direct eval always places all declarations into a new Environment Record.
31. Else, let *lexEnv* be *varEnv*.
32. Set the LexicalEnvironment of *calleeContext* to *lexEnv*.
33. Let *lexDeclarations* be the LexicallyScopedDeclarations of *code*.
34. For each element *d* of *lexDeclarations*, do
- a. NOTE: A lexically declared name cannot be the same as a function/generator declaration, formal parameter, or a var name. Lexically declared names are only instantiated here but not initialized.
  - b. For each element *dn* of the BoundNames of *d*, do
    - i. If `IsConstantDeclaration` of *d* is **true**, then
      1. Perform ! *lexEnv*.CreateImmutableBinding(*dn*, **true**).
    - ii. Else,
      1. Perform ! *lexEnv*.CreateMutableBinding(*dn*, **false**).
35. Let *privateEnv* be the PrivateEnvironment of *calleeContext*.
36. For each Parse Node *f* of *functionsToInitialize*, do
- a. Let *fn* be the sole element of the BoundNames of *f*.
  - b. Let *fo* be `InstantiateFunctionObject` of *f* with arguments *lexEnv* and *privateEnv*.
  - c. Perform ! *varEnv*.SetMutableBinding(*fn*, *fo*, **false**).
37. Return unused.

NOTE 2 B.3.2 provides an extension to the above algorithm that is necessary for backwards compatibility with web browser implementations of ECMAScript that predate ECMAScript 2015.

### 10.3 Built-in Function Objects

The built-in function objects defined in this specification may be implemented as either ECMAScript function objects (10.2) whose behaviour is provided using ECMAScript code or as function objects whose behaviour

is provided in some other manner. In either case, the effect of calling such functions must conform to their specifications. An implementation may also provide additional built-in [function objects](#) that are not defined in this specification.

If a built-in [function object](#) is implemented as an ECMAScript [function object](#), it must have all the internal slots described in 10.2 ([[Prototype]], [[Extensible]], and the slots listed in Table 30), and [[InitialName]]. The value of the [[InitialName]] internal slot is a [String](#) value that is the initial name of the function. It is used by 20.2.3.5.

Built-in [function objects](#) must have the [ordinary object](#) behaviour specified in 10.1. All such [function objects](#) have [[Prototype]], [[Extensible]], [[Realm]], and [[InitialName]] internal slots, with the same meanings as above.

Unless otherwise specified every built-in [function object](#) has the `%Function.prototype%` object as the initial value of its [[Prototype]] internal slot.

The behaviour specified for each built-in function via algorithm steps or other means is the specification of the function body behaviour for both [[Call]] and [[Construct]] invocations of the function. However, [[Construct]] invocation is not supported by all built-in functions. For each built-in function, when invoked with [[Call]], the [[Call]] [thisArgument](#) provides the **this** value, the [[Call]] [argumentsList](#) provides the named parameters, and the NewTarget value is **undefined**. When invoked with [[Construct]], the **this** value is uninitialized, the [[Construct]] [argumentsList](#) provides the named parameters, and the [[Construct]] [newTarget](#) parameter provides the NewTarget value. If the built-in function is implemented as an ECMAScript [function object](#) then this specified behaviour must be implemented by the ECMAScript code that is the body of the function. Built-in functions that are ECMAScript [function objects](#) must be [strict functions](#). If a built-in [constructor](#) has any [[Call]] behaviour other than throwing a **TypeError** exception, an ECMAScript implementation of the function must be done in a manner that does not cause the function's [[IsClassConstructor]] internal slot to have the value **true**.

Built-in [function objects](#) that are not identified as [constructors](#) do not implement the [[Construct]] internal method unless otherwise specified in the description of a particular function. When a built-in [constructor](#) is called as part of a **new** expression the [argumentsList](#) parameter of the invoked [[Construct]] internal method provides the values for the built-in [constructor](#)'s named parameters.

Built-in functions that are not [constructors](#) do not have a **"prototype"** property unless otherwise specified in the description of a particular function.

If a built-in [function object](#) is not implemented as an ECMAScript function it must provide [[Call]] and [[Construct]] internal methods that conform to the following definitions:

### 10.3.1 [[Call]] ( [thisArgument](#), [argumentsList](#) )

The [[Call]] internal method of a built-in [function object](#) *F* takes arguments [thisArgument](#) (an ECMAScript [language value](#)) and [argumentsList](#) (a [List](#) of ECMAScript [language values](#)) and returns either a [normal completion](#) containing an ECMAScript [language value](#) or a [throw completion](#). It performs the following steps when called:

1. Let [callerContext](#) be the [running execution context](#).
2. If [callerContext](#) is not already suspended, suspend [callerContext](#).
3. Let [calleeContext](#) be a new [execution context](#).
4. Set the Function of [calleeContext](#) to *F*.
5. Let [calleeRealm](#) be *F*.[[Realm]].
6. Set the [Realm](#) of [calleeContext](#) to [calleeRealm](#).
7. Set the ScriptOrModule of [calleeContext](#) to **null**.
8. Perform any necessary [implementation-defined](#) initialization of [calleeContext](#).
9. Push [calleeContext](#) onto the [execution context stack](#); [calleeContext](#) is now the [running execution context](#).
10. Let [result](#) be the [Completion Record](#) that is the result of evaluating *F* in a manner that conforms to the specification of *F*. [thisArgument](#) is the **this** value, [argumentsList](#) provides the named parameters, and

the `NewTarget` value is **undefined**.

11. Remove `calleeContext` from the `execution context stack` and restore `callerContext` as the `running execution context`.
12. Return ? `result`.

**NOTE** When `calleeContext` is removed from the `execution context stack` it must not be destroyed if it has been suspended and retained by an accessible Generator for later resumption.

### 10.3.2 `[[Construct]]` ( `argumentsList`, `newTarget` )

The `[[Construct]]` internal method of a built-in `function object`  $F$  (when the method is present) takes arguments `argumentsList` (a `List` of ECMAScript language values) and `newTarget` (a `constructor`) and returns either a `normal completion` containing an `Object` or a `throw completion`. The steps performed are the same as `[[Call]]` (see 10.3.1) except that step 10 is replaced by:

10. Let `result` be the `Completion Record` that is the result of evaluating  $F$  in a manner that conforms to the specification of  $F$ . The **this** value is uninitialized, `argumentsList` provides the named parameters, and `newTarget` provides the `NewTarget` value.

### 10.3.3 `CreateBuiltinFunction` ( `behaviour`, `length`, `name`, `additionalInternalSlotsList` [ , `realm` [ , `prototype` [ , `prefix` ] ] ] )

The abstract operation `CreateBuiltinFunction` takes arguments `behaviour` (an `Abstract Closure`, a set of algorithm steps, or some other definition of a function's behaviour provided in this specification), `length` (a non-negative `integer` or  $+\infty$ ), `name` (a `property key` or a `Private Name`), and `additionalInternalSlotsList` (a `List` of names of internal slots) and optional arguments `realm` (a `Realm Record`), `prototype` (an `Object` or `null`), and `prefix` (a `String`) and returns a `function object`. `additionalInternalSlotsList` contains the names of additional internal slots that must be defined as part of the object. This operation creates a built-in `function object`. It performs the following steps when called:

1. If `realm` is not present, set `realm` to the `current Realm Record`.
2. If `prototype` is not present, set `prototype` to `realm.[[Intrinsics]].[[%Function.prototype%]]`.
3. Let `internalSlotsList` be a `List` containing the names of all the internal slots that 10.3 requires for the built-in `function object` that is about to be created.
4. Append to `internalSlotsList` the elements of `additionalInternalSlotsList`.
5. Let `func` be a new built-in `function object` that, when called, performs the action described by `behaviour` using the provided arguments as the values of the corresponding parameters specified by `behaviour`. The new `function object` has internal slots whose names are the elements of `internalSlotsList`, and an `[[InitialName]]` internal slot.
6. Set `func.[[Prototype]]` to `prototype`.
7. Set `func.[[Extensible]]` to **true**.
8. Set `func.[[Realm]]` to `realm`.
9. Set `func.[[InitialName]]` to **null**.
10. Perform `SetFunctionLength(func, length)`.
11. If `prefix` is not present, then
  - a. Perform `SetFunctionName(func, name)`.
12. Else,
  - a. Perform `SetFunctionName(func, name, prefix)`.
13. Return `func`.

Each built-in function defined in this specification is created by calling the `CreateBuiltinFunction` abstract operation.



## 10.4 Built-in Exotic Object Internal Methods and Slots

This specification defines several kinds of built-in *exotic objects*. These objects generally behave similar to *ordinary objects* except for a few specific situations. The following *exotic objects* use the *ordinary object* internal methods except where it is explicitly specified otherwise below:

### 10.4.1 Bound Function Exotic Objects

A *bound function exotic object* is an *exotic object* that wraps another *function object*. A *bound function exotic object* is callable (it has a `[[Call]]` internal method and may have a `[[Construct]]` internal method). Calling a *bound function exotic object* generally results in a call of its wrapped function.

An object is a *bound function exotic object* if its `[[Call]]` and (if applicable) `[[Construct]]` internal methods use the following implementations, and its other essential internal methods use the definitions found in 10.1. These methods are installed in `BoundFunctionCreate`.

*Bound function exotic objects* do not have the internal slots of ECMAScript *function objects* listed in Table 30. Instead they have the internal slots listed in Table 31, in addition to `[[Prototype]]` and `[[Extensible]]`.

Table 31: Internal Slots of Bound Function Exotic Objects

Internal Slot	Type	Description
<code>[[BoundTargetFunction]]</code>	a callable Object	The wrapped <i>function object</i> .
<code>[[BoundThis]]</code>	an <i>ECMAScript language value</i>	The value that is always passed as the <b>this</b> value when calling the wrapped function.
<code>[[BoundArguments]]</code>	a <i>List of ECMAScript language values</i>	A list of values whose elements are used as the first arguments to any call to the wrapped function.

#### 10.4.1.1 `[[Call]]` ( *thisArgument*, *argumentsList* )

The `[[Call]]` internal method of a *bound function exotic object* *F* takes arguments *thisArgument* (an *ECMAScript language value*) and *argumentsList* (a *List of ECMAScript language values*) and returns either a *normal completion* containing an *ECMAScript language value* or a *throw completion*. It performs the following steps when called:

1. Let *target* be *F*.`[[BoundTargetFunction]]`.
2. Let *boundThis* be *F*.`[[BoundThis]]`.
3. Let *boundArgs* be *F*.`[[BoundArguments]]`.
4. Let *args* be the *list-concatenation* of *boundArgs* and *argumentsList*.
5. Return ? `Call(target, boundThis, args)`.

#### 10.4.1.2 `[[Construct]]` ( *argumentsList*, *newTarget* )

The `[[Construct]]` internal method of a *bound function exotic object* *F* takes arguments *argumentsList* (a *List of ECMAScript language values*) and *newTarget* (a *constructor*) and returns either a *normal completion* containing an Object or a *throw completion*. It performs the following steps when called:

1. Let *target* be *F*.`[[BoundTargetFunction]]`.
2. **Assert:** `IsConstructor(target)` is **true**.
3. Let *boundArgs* be *F*.`[[BoundArguments]]`.
4. Let *args* be the *list-concatenation* of *boundArgs* and *argumentsList*.

5. If `SameValue(F, newTarget)` is **true**, set `newTarget` to `target`.
6. Return ? `Construct(target, args, newTarget)`.

### 10.4.1.3 BoundFunctionCreate ( *targetFunction*, *boundThis*, *boundArgs* )

The abstract operation BoundFunctionCreate takes arguments *targetFunction* (a function object), *boundThis* (an ECMAScript language value), and *boundArgs* (a List of ECMAScript language values) and returns either a normal completion containing a function object or a throw completion. It is used to specify the creation of new bound function exotic objects. It performs the following steps when called:

1. Let *proto* be ? `targetFunction`.[[GetPrototypeOf]]().
2. Let *internalSlotsList* be the list-concatenation of « [[Prototype]], [[Extensible]] » and the internal slots listed in Table 31.
3. Let *obj* be `MakeBasicObject(internalSlotsList)`.
4. Set *obj*.[[Prototype]] to *proto*.
5. Set *obj*.[[Call]] as described in 10.4.1.1.
6. If `IsConstructor(targetFunction)` is **true**, then
  - a. Set *obj*.[[Construct]] as described in 10.4.1.2.
7. Set *obj*.[[BoundTargetFunction]] to `targetFunction`.
8. Set *obj*.[[BoundThis]] to `boundThis`.
9. Set *obj*.[[BoundArguments]] to `boundArgs`.
10. Return *obj*.

## 10.4.2 Array Exotic Objects

An Array is an exotic object that gives special treatment to array index property keys (see 6.1.7). A property whose property name is an array index is also called an *element*. Every Array has a non-configurable "length" property whose value is always a non-negative integral Number whose mathematical value is strictly less than  $2^{32}$ . The value of the "length" property is numerically greater than the name of every own property whose name is an array index; whenever an own property of an Array is created or changed, other properties are adjusted as necessary to maintain this invariant. Specifically, whenever an own property is added whose name is an array index, the value of the "length" property is changed, if necessary, to be one more than the numeric value of that array index; and whenever the value of the "length" property is changed, every own property whose name is an array index whose value is not smaller than the new length is deleted. This constraint applies only to own properties of an Array and is unaffected by "length" or array index properties that may be inherited from its prototypes.

**NOTE** A String property name *P* is an array index if and only if `ToString(ToUint32(P))` is *P* and `ToUint32(P)` is not  $\mathbb{F}(2^{32} - 1)$ .

An object is an Array exotic object (or simply, an Array) if its [[DefineOwnProperty]] internal method uses the following implementation, and its other essential internal methods use the definitions found in 10.1. These methods are installed in `ArrayCreate`.

### 10.4.2.1 [[DefineOwnProperty]] ( *P*, *Desc* )

The [[DefineOwnProperty]] internal method of an Array exotic object *A* takes arguments *P* (a property key) and *Desc* (a Property Descriptor) and returns either a normal completion containing a Boolean or a throw completion. It performs the following steps when called:

1. If *P* is "length", then
  - a. Return ? *ArraySetLength*(*A*, *Desc*).
2. Else if *P* is an array index, then
  - a. Let *lengthDesc* be *OrdinaryGetOwnProperty*(*A*, "length").
  - b. Assert: *IsDataDescriptor*(*lengthDesc*) is true.
  - c. Assert: *lengthDesc*.[[Configurable]] is false.
  - d. Let *length* be *lengthDesc*.[[Value]].
  - e. Assert: *length* is a non-negative integral Number.
  - f. Let *index* be ! *ToUint32*(*P*).
  - g. If *index* ≥ *length* and *lengthDesc*.[[Writable]] is false, return false.
  - h. Let *succeeded* be ! *OrdinaryDefineOwnProperty*(*A*, *P*, *Desc*).
  - i. If *succeeded* is false, return false.
  - j. If *index* ≥ *length*, then
    - i. Set *lengthDesc*.[[Value]] to *index* + 1.
    - ii. Set *succeeded* to ! *OrdinaryDefineOwnProperty*(*A*, "length", *lengthDesc*).
    - iii. Assert: *succeeded* is true.
  - k. Return true.
3. Return ? *OrdinaryDefineOwnProperty*(*A*, *P*, *Desc*).

#### 10.4.2.2 ArrayCreate ( *length* [ , *proto* ] )

The abstract operation ArrayCreate takes argument *length* (a non-negative integer) and optional argument *proto* (an Object) and returns either a normal completion containing an Array exotic object or a throw completion. It is used to specify the creation of new Arrays. It performs the following steps when called:

1. If *length* > 2<sup>32</sup> - 1, throw a **RangeError** exception.
2. If *proto* is not present, set *proto* to %Array.prototype%.
3. Let *A* be *MakeBasicObject*(« [[Prototype]], [[Extensible]] »).
4. Set *A*.[[Prototype]] to *proto*.
5. Set *A*.[[DefineOwnProperty]] as specified in 10.4.2.1.
6. Perform ! *OrdinaryDefineOwnProperty*(*A*, "length", PropertyDescriptor { [[Value]]: *ℱ*(*length*), [[Writable]]: true, [[Enumerable]]: false, [[Configurable]]: false }).
7. Return *A*.

#### 10.4.2.3 ArraySpeciesCreate ( *originalArray*, *length* )

The abstract operation ArraySpeciesCreate takes arguments *originalArray* (an Object) and *length* (a non-negative integer) and returns either a normal completion containing an Object or a throw completion. It is used to specify the creation of a new Array or similar object using a constructor function that is derived from *originalArray*. It does not enforce that the constructor function returns an Array. It performs the following steps when called:

1. Let *isArray* be ? *isArray*(*originalArray*).
2. If *isArray* is false, return ? *ArrayCreate*(*length*).
3. Let *C* be ? *Get*(*originalArray*, "constructor").
4. If *IsConstructor*(*C*) is true, then
  - a. Let *thisRealm* be the current Realm Record.
  - b. Let *realmC* be ? *GetFunctionRealm*(*C*).
  - c. If *thisRealm* and *realmC* are not the same Realm Record, then
    - i. If *SameValue*(*C*, *realmC*.[[Intrinsics]].[%Array%]) is true, set *C* to undefined.
5. If *C* is an Object, then

- a. Set *C* to ? *Get*(*C*, @@species).
  - b. If *C* is **null**, set *C* to **undefined**.
6. If *C* is **undefined**, return ? *ArrayCreate*(*length*).
  7. If *IsConstructor*(*C*) is **false**, throw a **TypeError** exception.
  8. Return ? *Construct*(*C*, « *F*(*length*) »).

**NOTE** If *originalArray* was created using the standard built-in Array constructor for a *realm* that is not the *realm* of the *running execution context*, then a new Array is created using the *realm* of the *running execution context*. This maintains compatibility with Web browsers that have historically had that behaviour for the **Array.prototype** methods that now are defined using *ArraySpeciesCreate*.

#### 10.4.2.4 *ArraySetLength* ( *A*, *Desc* )

The abstract operation *ArraySetLength* takes arguments *A* (an Array) and *Desc* (a *Property Descriptor*) and returns either a *normal completion* containing a Boolean or a *throw completion*. It performs the following steps when called:

1. If *Desc* does not have a *[[Value]]* field, then
  - a. Return ! *OrdinaryDefineOwnProperty*(*A*, "length", *Desc*).
2. Let *newLenDesc* be a copy of *Desc*.
3. Let *newLen* be ? *ToUint32*(*Desc*.[[Value]]).
4. Let *numberLen* be ? *ToNumber*(*Desc*.[[Value]]).
5. If *SameValueZero*(*newLen*, *numberLen*) is **false**, throw a **RangeError** exception.
6. Set *newLenDesc*.[[Value]] to *newLen*.
7. Let *oldLenDesc* be *OrdinaryGetOwnProperty*(*A*, "length").
8. **Assert**: *IsDataDescriptor*(*oldLenDesc*) is **true**.
9. **Assert**: *oldLenDesc*.[[Configurable]] is **false**.
10. Let *oldLen* be *oldLenDesc*.[[Value]].
11. If *newLen* ≥ *oldLen*, then
  - a. Return ! *OrdinaryDefineOwnProperty*(*A*, "length", *newLenDesc*).
12. If *oldLenDesc*.[[Writable]] is **false**, return **false**.
13. If *newLenDesc* does not have a *[[Writable]]* field or *newLenDesc*.[[Writable]] is **true**, let *newWritable* be **true**.
14. Else,
  - a. **NOTE**: Setting the *[[Writable]]* attribute to **false** is deferred in case any elements cannot be deleted.
  - b. Let *newWritable* be **false**.
  - c. Set *newLenDesc*.[[Writable]] to **true**.
15. Let *succeeded* be ! *OrdinaryDefineOwnProperty*(*A*, "length", *newLenDesc*).
16. If *succeeded* is **false**, return **false**.
17. For each own *property key P* of *A* such that *P* is an *array index* and ! *ToUint32*(*P*) ≥ *newLen*, in descending numeric index order, do
  - a. Let *deleteSucceeded* be ! *A*.[[Delete]](*P*).
  - b. If *deleteSucceeded* is **false**, then
    - i. Set *newLenDesc*.[[Value]] to ! *ToUint32*(*P*) + 1<sub>F</sub>.
    - ii. If *newWritable* is **false**, set *newLenDesc*.[[Writable]] to **false**.
    - iii. Perform ! *OrdinaryDefineOwnProperty*(*A*, "length", *newLenDesc*).
    - iv. Return **false**.
18. If *newWritable* is **false**, then
  - a. Set *succeeded* to ! *OrdinaryDefineOwnProperty*(*A*, "length", *PropertyDescriptor* { *[[Writable]]*: **false** }).

- b. Assert: *succeeded* is **true**.
19. Return **true**.

NOTE In steps 3 and 4, if *Desc*.[[Value]] is an object then its *valueOf* method is called twice. This is legacy behaviour that was specified with this effect starting with the 2<sup>nd</sup> Edition of this specification.

### 10.4.3 String Exotic Objects

A String object is an *exotic object* that encapsulates a String value and exposes virtual integer-indexed *data properties* corresponding to the individual code unit elements of the String value. *String exotic objects* always have a *data property* named **"length"** whose value is the length of the encapsulated String value. Both the code unit *data properties* and the **"length"** property are non-writable and non-configurable.

An object is a *String exotic object* (or simply, a String object) if its [[GetOwnProperty]], [[DefineOwnProperty]], and [[OwnPropertyKeys]] internal methods use the following implementations, and its other essential internal methods use the definitions found in 10.1. These methods are installed in *StringCreate*.

*String exotic objects* have the same internal slots as *ordinary objects*. They also have a [[StringData]] internal slot.

#### 10.4.3.1 [[GetOwnProperty]] ( *P* )

The [[GetOwnProperty]] internal method of a *String exotic object S* takes argument *P* (a *property key*) and returns a *normal completion containing* either a *Property Descriptor* or **undefined**. It performs the following steps when called:

1. Let *desc* be *OrdinaryGetOwnProperty*(*S*, *P*).
2. If *desc* is not **undefined**, return *desc*.
3. Return *StringGetOwnProperty*(*S*, *P*).

#### 10.4.3.2 [[DefineOwnProperty]] ( *P*, *Desc* )

The [[DefineOwnProperty]] internal method of a *String exotic object S* takes arguments *P* (a *property key*) and *Desc* (a *Property Descriptor*) and returns a *normal completion containing* a Boolean. It performs the following steps when called:

1. Let *stringDesc* be *StringGetOwnProperty*(*S*, *P*).
2. If *stringDesc* is not **undefined**, then
  - a. Let *extensible* be *S*.[[Extensible]].
  - b. Return *IsCompatiblePropertyDescriptor*(*extensible*, *Desc*, *stringDesc*).
3. Return ! *OrdinaryDefineOwnProperty*(*S*, *P*, *Desc*).

#### 10.4.3.3 [[OwnPropertyKeys]] ( )

The [[OwnPropertyKeys]] internal method of a *String exotic object O* takes no arguments and returns a *normal completion containing* a *List* of *property keys*. It performs the following steps when called:

1. Let *keys* be a new empty *List*.
2. Let *str* be *O*.[[StringData]].
3. Assert: *str* is a *String*.
4. Let *len* be the length of *str*.
5. For each integer *i* such that  $0 \leq i < len$ , in ascending order, do

- a. Append ! ToString( $\mathbb{F}(i)$ ) to *keys*.
6. For each own property key *P* of *O* such that *P* is an array index and ! ToIntegerOrInfinity(*P*)  $\geq$  *len*, in ascending numeric index order, do
  - a. Append *P* to *keys*.
7. For each own property key *P* of *O* such that *P* is a String and *P* is not an array index, in ascending chronological order of property creation, do
  - a. Append *P* to *keys*.
8. For each own property key *P* of *O* such that *P* is a Symbol, in ascending chronological order of property creation, do
  - a. Append *P* to *keys*.
9. Return *keys*.

#### 10.4.3.4 StringCreate ( *value*, *prototype* )

The abstract operation StringCreate takes arguments *value* (a String) and *prototype* (an Object) and returns a String exotic object. It is used to specify the creation of new String exotic objects. It performs the following steps when called:

1. Let *S* be MakeBasicObject(« [[Prototype]], [[Extensible]], [[StringData]] »).
2. Set *S*.[[Prototype]] to *prototype*.
3. Set *S*.[[StringData]] to *value*.
4. Set *S*.[[GetOwnProperty]] as specified in 10.4.3.1.
5. Set *S*.[[DefineOwnProperty]] as specified in 10.4.3.2.
6. Set *S*.[[OwnPropertyKeys]] as specified in 10.4.3.3.
7. Let *length* be the length of *value*.
8. Perform ! DefinePropertyOrThrow(*S*, "length", PropertyDescriptor { [[Value]]:  $\mathbb{F}(\textit{length})$ , [[Writable]]: **false**, [[Enumerable]]: **false**, [[Configurable]]: **false** }).
9. Return *S*.

#### 10.4.3.5 StringGetOwnProperty ( *S*, *P* )

The abstract operation StringGetOwnProperty takes arguments *S* (an Object that has a [[StringData]] internal slot) and *P* (a property key) and returns a Property Descriptor or **undefined**. It performs the following steps when called:

1. If *P* is not a String, return **undefined**.
2. Let *index* be CanonicalNumericIndexString(*P*).
3. If *index* is **undefined**, return **undefined**.
4. If !IsIntegralNumber(*index*) is **false**, return **undefined**.
5. If *index* is  $-0_{\mathbb{F}}$ , return **undefined**.
6. Let *str* be *S*.[[StringData]].
7. Assert: *str* is a String.
8. Let *len* be the length of *str*.
9. If  $\mathbb{R}(\textit{index}) < 0$  or  $\textit{len} \leq \mathbb{R}(\textit{index})$ , return **undefined**.
10. Let *resultStr* be the substring of *str* from  $\mathbb{R}(\textit{index})$  to  $\mathbb{R}(\textit{index}) + 1$ .
11. Return the PropertyDescriptor { [[Value]]: *resultStr*, [[Writable]]: **false**, [[Enumerable]]: **true**, [[Configurable]]: **false** }.

### 10.4.4 Arguments Exotic Objects

Most ECMAScript functions make an arguments object available to their code. Depending upon the characteristics of the function definition, its arguments object is either an ordinary object or an arguments

**arguments exotic object**. An **arguments exotic object** is an **arguments object** whose **array index** properties map to the formal parameters bindings of an invocation of its associated ECMAScript function.

An object is an **arguments exotic object** if its internal methods use the following implementations, with the ones not specified here using those found in 10.1. These methods are installed in `CreateMappedArgumentsObject`.

NOTE 1 While `CreateUnmappedArgumentsObject` is grouped into this clause, it creates an **ordinary object**, not an **arguments exotic object**.

**Arguments exotic objects** have the same internal slots as **ordinary objects**. They also have a `[[ParameterMap]]` internal slot. Ordinary arguments objects also have a `[[ParameterMap]]` internal slot whose value is always undefined. For ordinary argument objects the `[[ParameterMap]]` internal slot is only used by `Object.prototype.toString` (20.1.3.6) to identify them as such.

NOTE 2 The **integer-indexed data properties** of an **arguments exotic object** whose numeric name values are less than the number of formal parameters of the corresponding **function object** initially share their values with the corresponding argument bindings in the function's **execution context**. This means that changing the property changes the corresponding value of the argument binding and vice-versa. This correspondence is broken if such a property is deleted and then redefined or if the property is changed into an **accessor property**. If the arguments object is an **ordinary object**, the values of its properties are simply a copy of the arguments passed to the function and there is no dynamic linkage between the property values and the formal parameter values.

NOTE 3 The `ParameterMap` object and its property values are used as a device for specifying the arguments object correspondence to argument bindings. The `ParameterMap` object and the objects that are the values of its properties are not directly observable from ECMAScript code. An ECMAScript implementation does not need to actually create or use such objects to implement the specified semantics.

NOTE 4 Ordinary arguments objects define a non-configurable **accessor property** named **"callee"** which throws a **TypeError** exception on access. The **"callee"** property has a more specific meaning for **arguments exotic objects**, which are created only for some class of **non-strict functions**. The definition of this property in the ordinary variant exists to ensure that it is not defined in any other manner by conforming ECMAScript implementations.

NOTE 5 ECMAScript implementations of **arguments exotic objects** have historically contained an **accessor property** named **"caller"**. Prior to ECMAScript 2017, this specification included the definition of a throwing **"caller"** property on ordinary arguments objects. Since implementations do not contain this extension any longer, ECMAScript 2017 dropped the requirement for a throwing **"caller"** accessor.

#### 10.4.4.1 `[[GetOwnProperty]]` ( *P* )

The `[[GetOwnProperty]]` internal method of an **arguments exotic object** *args* takes argument *P* (a **property key**) and returns a **normal completion containing** either a **Property Descriptor** or **undefined**. It performs the following steps when called:

1. Let *desc* be `OrdinaryGetOwnProperty(args, P)`.
2. If *desc* is **undefined**, return *desc*.
3. Let *map* be *args*.`[[ParameterMap]]`.
4. Let *isMapped* be `! HasOwnProperty(map, P)`.
5. If *isMapped* is **true**, then

- a. Set *desc*.[[Value]] to ! *Get*(*map*, *P*).
6. Return *desc*.

#### 10.4.4.2 [[DefineOwnProperty]] ( *P*, *Desc* )

The [[DefineOwnProperty]] internal method of an *arguments* exotic object *args* takes arguments *P* (a *property key*) and *Desc* (a *Property Descriptor*) and returns a *normal completion* containing a Boolean. It performs the following steps when called:

1. Let *map* be *args*.[[ParameterMap]].
2. Let *isMapped* be ! *HasOwnProperty*(*map*, *P*).
3. Let *newArgDesc* be *Desc*.
4. If *isMapped* is **true** and *IsDataDescriptor*(*Desc*) is **true**, then
  - a. If *Desc* does not have a [[Value]] field, *Desc* has a [[Writable]] field, and *Desc*.[[Writable]] is **false**, then
    - i. Set *newArgDesc* to a copy of *Desc*.
    - ii. Set *newArgDesc*.[[Value]] to ! *Get*(*map*, *P*).
5. Let *allowed* be ! *OrdinaryDefineOwnProperty*(*args*, *P*, *newArgDesc*).
6. If *allowed* is **false**, return **false**.
7. If *isMapped* is **true**, then
  - a. If *IsAccessorDescriptor*(*Desc*) is **true**, then
    - i. Perform ! *map*.[[Delete]](*P*).
  - b. Else,
    - i. If *Desc* has a [[Value]] field, then
      1. *Assert*: The following Set will succeed, since formal parameters mapped by arguments objects are always writable.
      2. Perform ! *Set*(*map*, *P*, *Desc*.[[Value]], **false**).
    - ii. If *Desc* has a [[Writable]] field and *Desc*.[[Writable]] is **false**, then
      1. Perform ! *map*.[[Delete]](*P*).
8. Return **true**.

#### 10.4.4.3 [[Get]] ( *P*, *Receiver* )

The [[Get]] internal method of an *arguments* exotic object *args* takes arguments *P* (a *property key*) and *Receiver* (an ECMAScript language value) and returns either a *normal completion* containing an ECMAScript language value or a *throw completion*. It performs the following steps when called:

1. Let *map* be *args*.[[ParameterMap]].
2. Let *isMapped* be ! *HasOwnProperty*(*map*, *P*).
3. If *isMapped* is **false**, then
  - a. Return ? *OrdinaryGet*(*args*, *P*, *Receiver*).
4. Else,
  - a. *Assert*: *map* contains a formal parameter mapping for *P*.
  - b. Return ! *Get*(*map*, *P*).

#### 10.4.4.4 [[Set]] ( *P*, *V*, *Receiver* )

The [[Set]] internal method of an *arguments* exotic object *args* takes arguments *P* (a *property key*), *V* (an ECMAScript language value), and *Receiver* (an ECMAScript language value) and returns either a *normal completion* containing a Boolean or a *throw completion*. It performs the following steps when called:

1. If *SameValue*(*args*, *Receiver*) is **false**, then



- a. Let *isMapped* be **false**.
2. Else,
  - a. Let *map* be *args*.[[ParameterMap]].
  - b. Let *isMapped* be ! *HasOwnProperty*(*map*, *P*).
3. If *isMapped* is **true**, then
  - a. **Assert**: The following Set will succeed, since formal parameters mapped by arguments objects are always writable.
  - b. Perform ! *Set*(*map*, *P*, *V*, **false**).
4. Return ? *OrdinarySet*(*args*, *P*, *V*, *Receiver*).

#### 10.4.4.5 [[Delete]] ( *P* )

The [[Delete]] internal method of an arguments exotic object *args* takes argument *P* (a property key) and returns either a normal completion containing a Boolean or a throw completion. It performs the following steps when called:

1. Let *map* be *args*.[[ParameterMap]].
2. Let *isMapped* be ! *HasOwnProperty*(*map*, *P*).
3. Let *result* be ? *OrdinaryDelete*(*args*, *P*).
4. If *result* is **true** and *isMapped* is **true**, then
  - a. Perform ! *map*.[[Delete]](*P*).
5. Return *result*.

#### 10.4.4.6 CreateUnmappedArgumentsObject ( *argumentsList* )

The abstract operation CreateUnmappedArgumentsObject takes argument *argumentsList* (a List of ECMAScript language values) and returns an ordinary object. It performs the following steps when called:

1. Let *len* be the number of elements in *argumentsList*.
2. Let *obj* be *OrdinaryObjectCreate*(%Object.prototype%, « [[ParameterMap]] »).
3. Set *obj*.[[ParameterMap]] to **undefined**.
4. Perform ! *DefinePropertyOrThrow*(*obj*, "length", PropertyDescriptor { [[Value]]:  $\mathbb{F}(\textit{len})$ , [[Writable]]: **true**, [[Enumerable]]: **false**, [[Configurable]]: **true** }).
5. Let *index* be 0.
6. Repeat, while *index* < *len*,
  - a. Let *val* be *argumentsList*[*index*].
  - b. Perform ! *CreateDataPropertyOrThrow*(*obj*, ! *ToString*( $\mathbb{F}(\textit{index})$ ), *val*).
  - c. Set *index* to *index* + 1.
7. Perform ! *DefinePropertyOrThrow*(*obj*, @@iterator, PropertyDescriptor { [[Value]]: %Array.prototype.values%, [[Writable]]: **true**, [[Enumerable]]: **false**, [[Configurable]]: **true** }).
8. Perform ! *DefinePropertyOrThrow*(*obj*, "callee", PropertyDescriptor { [[Get]]: %ThrowTypeError%, [[Set]]: %ThrowTypeError%, [[Enumerable]]: **false**, [[Configurable]]: **false** }).
9. Return *obj*.

#### 10.4.4.7 CreateMappedArgumentsObject ( *func*, *formals*, *argumentsList*, *env* )

The abstract operation CreateMappedArgumentsObject takes arguments *func* (an Object), *formals* (a Parse Node), *argumentsList* (a List of ECMAScript language values), and *env* (an Environment Record) and returns an arguments exotic object. It performs the following steps when called:

1. **Assert**: *formals* does not contain a rest parameter, any binding patterns, or any initializers. It may contain duplicate identifiers.

2. Let *len* be the number of elements in *argumentsList*.
3. Let *obj* be `MakeBasicObject`(« `[[Prototype]]`, `[[Extensible]]`, `[[ParameterMap]]` »).
4. Set *obj*.`[[GetOwnProperty]]` as specified in 10.4.4.1.
5. Set *obj*.`[[DefineOwnProperty]]` as specified in 10.4.4.2.
6. Set *obj*.`[[Get]]` as specified in 10.4.4.3.
7. Set *obj*.`[[Set]]` as specified in 10.4.4.4.
8. Set *obj*.`[[Delete]]` as specified in 10.4.4.5.
9. Set *obj*.`[[Prototype]]` to `%Object.prototype%`.
10. Let *map* be `OrdinaryObjectCreate`(`null`).
11. Set *obj*.`[[ParameterMap]]` to *map*.
12. Let *parameterNames* be the `BoundNames` of *formals*.
13. Let *numberOfParameters* be the number of elements in *parameterNames*.
14. Let *index* be 0.
15. Repeat, while *index* < *len*,
  - a. Let *val* be *argumentsList*[*index*].
  - b. Perform ! `CreateDataPropertyOrThrow`(*obj*, ! `ToString`(`ℱ`(*index*)), *val*).
  - c. Set *index* to *index* + 1.
16. Perform ! `DefinePropertyOrThrow`(*obj*, "length", `PropertyDescriptor` { `[[Value]]`: `ℱ`(*len*), `[[Writable]]`: `true`, `[[Enumerable]]`: `false`, `[[Configurable]]`: `true` }).
17. Let *mappedNames* be a new empty `List`.
18. Set *index* to *numberOfParameters* - 1.
19. Repeat, while *index* ≥ 0,
  - a. Let *name* be *parameterNames*[*index*].
  - b. If *mappedNames* does not contain *name*, then
    - i. Append *name* to *mappedNames*.
    - ii. If *index* < *len*, then
      1. Let *g* be `MakeArgGetter`(*name*, *env*).
      2. Let *p* be `MakeArgSetter`(*name*, *env*).
      3. Perform ! *map*.`[[DefineOwnProperty]]`(! `ToString`(`ℱ`(*index*)), `PropertyDescriptor` { `[[Set]]`: *p*, `[[Get]]`: *g*, `[[Enumerable]]`: `false`, `[[Configurable]]`: `true` }).
  - c. Set *index* to *index* - 1.
20. Perform ! `DefinePropertyOrThrow`(*obj*, `@@iterator`, `PropertyDescriptor` { `[[Value]]`: `%Array.prototype.values%`, `[[Writable]]`: `true`, `[[Enumerable]]`: `false`, `[[Configurable]]`: `true` }).
21. Perform ! `DefinePropertyOrThrow`(*obj*, "callee", `PropertyDescriptor` { `[[Value]]`: *func*, `[[Writable]]`: `true`, `[[Enumerable]]`: `false`, `[[Configurable]]`: `true` }).
22. Return *obj*.

#### 10.4.4.7.1 MakeArgGetter ( *name*, *env* )

The abstract operation `MakeArgGetter` takes arguments *name* (a `String`) and *env* (an `Environment Record`) and returns a `function object`. It creates a built-in `function object` that when executed returns the value bound for *name* in *env*. It performs the following steps when called:

1. Let *getterClosure* be a new `Abstract Closure` with no parameters that captures *name* and *env* and performs the following steps when called:
  - a. Return *env*.`GetBindingValue`(*name*, `false`).
2. Let *getter* be `CreateBuiltinFunction`(*getterClosure*, 0, "", « »).
3. NOTE: *getter* is never directly accessible to ECMAScript code.
4. Return *getter*.

#### 10.4.4.7.2 MakeArgSetter ( *name*, *env* )

The abstract operation MakeArgSetter takes arguments *name* (a String) and *env* (an Environment Record) and returns a function object. It creates a built-in function object that when executed sets the value bound for *name* in *env*. It performs the following steps when called:

1. Let *setterClosure* be a new Abstract Closure with parameters (*value*) that captures *name* and *env* and performs the following steps when called:
  - a. Return ! *env*.SetMutableBinding(*name*, *value*, **false**).
2. Let *setter* be CreateBuiltinFunction(*setterClosure*, 1, "", « »).
3. NOTE: *setter* is never directly accessible to ECMAScript code.
4. Return *setter*.

### 10.4.5 Integer-Indexed Exotic Objects

An Integer-Indexed exotic object is an exotic object that performs special handling of integer index property keys.

Integer-Indexed exotic objects have the same internal slots as ordinary objects and additionally [[ViewedArrayBuffer]], [[ArrayLength]], [[ByteOffset]], [[ContentType]], and [[TypedArrayName]] internal slots.

An object is an *Integer-Indexed exotic object* if its [[GetOwnProperty]], [[HasProperty]], [[DefineOwnProperty]], [[Get]], [[Set]], [[Delete]], and [[OwnPropertyKeys]] internal methods use the definitions in this section, and its other essential internal methods use the definitions found in 10.1. These methods are installed by IntegerIndexedObjectCreate.

#### 10.4.5.1 [[GetOwnProperty]] ( *P* )

The [[GetOwnProperty]] internal method of an Integer-Indexed exotic object *O* takes argument *P* (a property key) and returns a normal completion containing either a Property Descriptor or **undefined**. It performs the following steps when called:

1. If *P* is a String, then
  - a. Let *numericIndex* be CanonicalNumericIndexString(*P*).
  - b. If *numericIndex* is not **undefined**, then
    - i. Let *value* be IntegerIndexedElementGet(*O*, *numericIndex*).
    - ii. If *value* is **undefined**, return **undefined**.
    - iii. Return the PropertyDescriptor { [[Value]]: *value*, [[Writable]]: **true**, [[Enumerable]]: **true**, [[Configurable]]: **true** }.
2. Return OrdinaryGetOwnProperty(*O*, *P*).

#### 10.4.5.2 [[HasProperty]] ( *P* )

The [[HasProperty]] internal method of an Integer-Indexed exotic object *O* takes argument *P* (a property key) and returns either a normal completion containing a Boolean or a throw completion. It performs the following steps when called:

1. If *P* is a String, then
  - a. Let *numericIndex* be CanonicalNumericIndexString(*P*).
  - b. If *numericIndex* is not **undefined**, return IsValidIntegerIndex(*O*, *numericIndex*).
2. Return ? OrdinaryHasProperty(*O*, *P*).

### 10.4.5.3 **[[DefineOwnProperty]]** ( *P*, *Desc* )

The **[[DefineOwnProperty]]** internal method of an **Integer-Indexed exotic object** *O* takes arguments *P* (a **property key**) and *Desc* (a **Property Descriptor**) and returns either a **normal completion** containing a Boolean or a **throw completion**. It performs the following steps when called:

1. If *P* is a **String**, then
  - a. Let *numericIndex* be **CanonicalNumericIndexString**(*P*).
  - b. If *numericIndex* is not **undefined**, then
    - i. If **IsValidIntegerIndex**(*O*, *numericIndex*) is **false**, return **false**.
    - ii. If *Desc* has a **[[Configurable]]** field and *Desc*.**[[Configurable]]** is **false**, return **false**.
    - iii. If *Desc* has an **[[Enumerable]]** field and *Desc*.**[[Enumerable]]** is **false**, return **false**.
    - iv. If **IsAccessorDescriptor**(*Desc*) is **true**, return **false**.
    - v. If *Desc* has a **[[Writable]]** field and *Desc*.**[[Writable]]** is **false**, return **false**.
    - vi. If *Desc* has a **[[Value]]** field, perform ? **IntegerIndexedElementSet**(*O*, *numericIndex*, *Desc*.**[[Value]]**).
    - vii. Return **true**.
2. Return ! **OrdinaryDefineOwnProperty**(*O*, *P*, *Desc*).

### 10.4.5.4 **[[Get]]** ( *P*, *Receiver* )

The **[[Get]]** internal method of an **Integer-Indexed exotic object** *O* takes arguments *P* (a **property key**) and *Receiver* (an **ECMAScript language value**) and returns either a **normal completion** containing an **ECMAScript language value** or a **throw completion**. It performs the following steps when called:

1. If *P* is a **String**, then
  - a. Let *numericIndex* be **CanonicalNumericIndexString**(*P*).
  - b. If *numericIndex* is not **undefined**, then
    - i. Return **IntegerIndexedElementGet**(*O*, *numericIndex*).
2. Return ? **OrdinaryGet**(*O*, *P*, *Receiver*).

### 10.4.5.5 **[[Set]]** ( *P*, *V*, *Receiver* )

The **[[Set]]** internal method of an **Integer-Indexed exotic object** *O* takes arguments *P* (a **property key**), *V* (an **ECMAScript language value**), and *Receiver* (an **ECMAScript language value**) and returns either a **normal completion** containing a Boolean or a **throw completion**. It performs the following steps when called:

1. If *P* is a **String**, then
  - a. Let *numericIndex* be **CanonicalNumericIndexString**(*P*).
  - b. If *numericIndex* is not **undefined**, then
    - i. If **SameValue**(*O*, *Receiver*) is **true**, then
      1. Perform ? **IntegerIndexedElementSet**(*O*, *numericIndex*, *V*).
      2. Return **true**.
    - ii. If **IsValidIntegerIndex**(*O*, *numericIndex*) is **false**, return **true**.
2. Return ? **OrdinarySet**(*O*, *P*, *V*, *Receiver*).

### 10.4.5.6 **[[Delete]]** ( *P* )

The **[[Delete]]** internal method of an **Integer-Indexed exotic object** *O* takes argument *P* (a **property key**) and returns a **normal completion** containing a Boolean. It performs the following steps when called:

1. If *P* is a **String**, then

- a. Let *numericIndex* be CanonicalNumericIndexString(*P*).
  - b. If *numericIndex* is not **undefined**, then
    - i. If IsValidIntegerIndex(*O*, *numericIndex*) is **false**, return **true**; else return **false**.
2. Return ! OrdinaryDelete(*O*, *P*).

#### 10.4.5.7 [[OwnPropertyKeys]] ( )

The [[OwnPropertyKeys]] internal method of an Integer-Indexed exotic object *O* takes no arguments and returns a normal completion containing a List of property keys. It performs the following steps when called:

1. Let *keys* be a new empty List.
2. If IsDetachedBuffer(*O*.[[ViewedArrayBuffer]]) is **false**, then
  - a. For each integer *i* such that  $0 \leq i < O.[[ArrayLength]]$ , in ascending order, do
    - i. Append ! ToString( $\mathbb{F}(i)$ ) to *keys*.
3. For each own property key *P* of *O* such that *P* is a String and *P* is not an integer index, in ascending chronological order of property creation, do
  - a. Append *P* to *keys*.
4. For each own property key *P* of *O* such that *P* is a Symbol, in ascending chronological order of property creation, do
  - a. Append *P* to *keys*.
5. Return *keys*.

#### 10.4.5.8 IntegerIndexedObjectCreate ( *prototype* )

The abstract operation IntegerIndexedObjectCreate takes argument *prototype* (an Object) and returns an Integer-Indexed exotic object. It is used to specify the creation of new Integer-Indexed exotic objects. It performs the following steps when called:

1. Let *internalSlotsList* be « [[Prototype]], [[Extensible]], [[ViewedArrayBuffer]], [[TypedArrayName]], [[ContentType]], [[ByteLength]], [[ByteOffset]], [[ArrayLength]] ».
2. Let *A* be MakeBasicObject(*internalSlotsList*).
3. Set *A*.[[GetOwnProperty]] as specified in 10.4.5.1.
4. Set *A*.[[HasProperty]] as specified in 10.4.5.2.
5. Set *A*.[[DefineOwnProperty]] as specified in 10.4.5.3.
6. Set *A*.[[Get]] as specified in 10.4.5.4.
7. Set *A*.[[Set]] as specified in 10.4.5.5.
8. Set *A*.[[Delete]] as specified in 10.4.5.6.
9. Set *A*.[[OwnPropertyKeys]] as specified in 10.4.5.7.
10. Set *A*.[[Prototype]] to *prototype*.
11. Return *A*.

#### 10.4.5.9 IsValidIntegerIndex ( *O*, *index* )

The abstract operation IsValidIntegerIndex takes arguments *O* (an Integer-Indexed exotic object) and *index* (a Number) and returns a Boolean. It performs the following steps when called:

1. If IsDetachedBuffer(*O*.[[ViewedArrayBuffer]]) is **true**, return **false**.
2. If IsIntegralNumber(*index*) is **false**, return **false**.
3. If *index* is  $-0_{\mathbb{F}}$ , return **false**.
4. If  $\mathbb{R}(index) < 0$  or  $\mathbb{R}(index) \geq O.[[ArrayLength]]$ , return **false**.
5. Return **true**.

#### 10.4.5.10 IntegerIndexedElementGet ( *O*, *index* )

The abstract operation IntegerIndexedElementGet takes arguments *O* (an [Integer-Indexed exotic object](#)) and *index* (a Number) and returns a Number, a BigInt, or **undefined**. It performs the following steps when called:

1. If `IsValidIntegerIndex(O, index)` is **false**, return **undefined**.
2. Let *offset* be `O.[[ByteOffset]]`.
3. Let *elementSize* be `TypedArrayElementSize(O)`.
4. Let *indexedPosition* be  $(\mathbb{R}(\textit{index}) \times \textit{elementSize}) + \textit{offset}$ .
5. Let *elementType* be `TypedArrayElementType(O)`.
6. Return `GetValueFromBuffer(O.[[ViewedArrayBuffer]], indexedPosition, elementType, true, Unordered)`.

#### 10.4.5.11 IntegerIndexedElementSet ( *O*, *index*, *value* )

The abstract operation IntegerIndexedElementSet takes arguments *O* (an [Integer-Indexed exotic object](#)), *index* (a Number), and *value* (an [ECMAScript language value](#)) and returns either a [normal completion containing](#) unused or a [throw completion](#). It performs the following steps when called:

1. If `O.[[ContentType]]` is BigInt, let *numValue* be `? ToBigInt(value)`.
2. Otherwise, let *numValue* be `? ToNumber(value)`.
3. If `IsValidIntegerIndex(O, index)` is **true**, then
  - a. Let *offset* be `O.[[ByteOffset]]`.
  - b. Let *elementSize* be `TypedArrayElementSize(O)`.
  - c. Let *indexedPosition* be  $(\mathbb{R}(\textit{index}) \times \textit{elementSize}) + \textit{offset}$ .
  - d. Let *elementType* be `TypedArrayElementType(O)`.
  - e. Perform `SetValueInBuffer(O.[[ViewedArrayBuffer]], indexedPosition, elementType, numValue, true, Unordered)`.
4. Return unused.

**NOTE** This operation always appears to succeed, but it has no effect when attempting to write past the end of a TypedArray or to a TypedArray which is backed by a detached ArrayBuffer.

### 10.4.6 Module Namespace Exotic Objects

A [module namespace exotic object](#) is an [exotic object](#) that exposes the bindings exported from an [ECMAScript Module](#) (See 16.2.3). There is a one-to-one correspondence between the String-keyed own properties of a [module namespace exotic object](#) and the binding names exported by the *Module*. The exported bindings include any bindings that are indirectly exported using **export \*** export items. Each String-valued own [property key](#) is the [StringValue](#) of the corresponding exported binding name. These are the only String-keyed properties of a [module namespace exotic object](#). Each such property has the attributes { `[[Writable]]`: **true**, `[[Enumerable]]`: **true**, `[[Configurable]]`: **false** }. [Module namespace exotic objects](#) are not extensible.

An object is a [module namespace exotic object](#) if its `[[GetPrototypeOf]]`, `[[SetPrototypeOf]]`, `[[IsExtensible]]`, `[[PreventExtensions]]`, `[[GetOwnProperty]]`, `[[DefineOwnProperty]]`, `[[HasProperty]]`, `[[Get]]`, `[[Set]]`, `[[Delete]]`, and `[[OwnPropertyKeys]]` internal methods use the definitions in this section, and its other essential internal methods use the definitions found in 10.1. These methods are installed by `ModuleNamespaceCreate`.

[Module namespace exotic objects](#) have the internal slots defined in [Table 32](#).

Table 32: Internal Slots of Module Namespace Exotic Objects

Internal Slot	Type	Description
[[Module]]	a <a href="#">Module Record</a>	The <a href="#">Module Record</a> whose exports this namespace exposes.
[[Exports]]	a <a href="#">List of Strings</a>	A <a href="#">List</a> whose elements are the String values of the exported names exposed as own properties of this object. The list is ordered as if an Array of those String values had been sorted using <code>%Array.prototype.sort%</code> using <b>undefined</b> as <a href="#">comparefn</a> .

#### 10.4.6.1 `[[GetPrototypeOf]]` ( )

The `[[GetPrototypeOf]]` internal method of a [module namespace exotic object](#) takes no arguments and returns a [normal completion containing null](#). It performs the following steps when called:

1. Return **null**.

#### 10.4.6.2 `[[SetPrototypeOf]]` ( *V* )

The `[[SetPrototypeOf]]` internal method of a [module namespace exotic object](#) *O* takes argument *V* (an Object or **null**) and returns a [normal completion containing](#) a Boolean. It performs the following steps when called:

1. Return ! `SetImmutablePrototype(O, V)`.

#### 10.4.6.3 `[[IsExtensible]]` ( )

The `[[IsExtensible]]` internal method of a [module namespace exotic object](#) takes no arguments and returns a [normal completion containing false](#). It performs the following steps when called:

1. Return **false**.

#### 10.4.6.4 `[[PreventExtensions]]` ( )

The `[[PreventExtensions]]` internal method of a [module namespace exotic object](#) takes no arguments and returns a [normal completion containing true](#). It performs the following steps when called:

1. Return **true**.

#### 10.4.6.5 `[[GetOwnProperty]]` ( *P* )

The `[[GetOwnProperty]]` internal method of a [module namespace exotic object](#) *O* takes argument *P* (a [property key](#)) and returns either a [normal completion containing](#) either a [Property Descriptor](#) or **undefined**, or a [throw completion](#). It performs the following steps when called:

1. If *P* is a [Symbol](#), return `OrdinaryGetOwnProperty(O, P)`.
2. Let *exports* be *O*.[[Exports]].
3. If *exports* does not contain *P*, return **undefined**.
4. Let *value* be ? *O*.[[Get]](*P*, *O*).
5. Return `PropertyDescriptor` { `[[Value]]`: *value*, `[[Writable]]`: **true**, `[[Enumerable]]`: **true**, `[[Configurable]]`: **false** }.

#### 10.4.6.6 `[[DefineOwnProperty]]` ( *P*, *Desc* )

The `[[DefineOwnProperty]]` internal method of a [module namespace exotic object](#) *O* takes arguments *P* (a [property key](#)) and *Desc* (a [Property Descriptor](#)) and returns either a [normal completion containing](#) a Boolean or a [throw completion](#). It performs the following steps when called:

1. If *P* is a [Symbol](#), return ! `OrdinaryDefineOwnProperty(O, P, Desc)`.
2. Let *current* be ? *O*.`[[GetOwnProperty]]`(*P*).
3. If *current* is **undefined**, return **false**.
4. If *Desc* has a `[[Configurable]]` field and *Desc*.`[[Configurable]]` is **true**, return **false**.
5. If *Desc* has an `[[Enumerable]]` field and *Desc*.`[[Enumerable]]` is **false**, return **false**.
6. If `IsAccessorDescriptor(Desc)` is **true**, return **false**.
7. If *Desc* has a `[[Writable]]` field and *Desc*.`[[Writable]]` is **false**, return **false**.
8. If *Desc* has a `[[Value]]` field, return `SameValue(Desc.[[Value]], current.[[Value]])`.
9. Return **true**.

#### 10.4.6.7 `[[HasProperty]]` ( *P* )

The `[[HasProperty]]` internal method of a [module namespace exotic object](#) *O* takes argument *P* (a [property key](#)) and returns a [normal completion containing](#) a Boolean. It performs the following steps when called:

1. If *P* is a [Symbol](#), return ! `OrdinaryHasProperty(O, P)`.
2. Let *exports* be *O*.`[[Exports]]`.
3. If *exports* contains *P*, return **true**.
4. Return **false**.

#### 10.4.6.8 `[[Get]]` ( *P*, *Receiver* )

The `[[Get]]` internal method of a [module namespace exotic object](#) *O* takes arguments *P* (a [property key](#)) and *Receiver* (an [ECMAScript language value](#)) and returns either a [normal completion containing](#) an [ECMAScript language value](#) or a [throw completion](#). It performs the following steps when called:

1. If *P* is a [Symbol](#), then
  - a. Return ! `OrdinaryGet(O, P, Receiver)`.
2. Let *exports* be *O*.`[[Exports]]`.
3. If *exports* does not contain *P*, return **undefined**.
4. Let *m* be *O*.`[[Module]]`.
5. Let *binding* be *m*.`ResolveExport(P)`.
6. **Assert**: *binding* is a [ResolvedBinding Record](#).
7. Let *targetModule* be *binding*.`[[Module]]`.
8. **Assert**: *targetModule* is not **undefined**.
9. If *binding*.`[[BindingName]]` is namespace, then
  - a. Return `GetModuleNamespace(targetModule)`.
10. Let *targetEnv* be *targetModule*.`[[Environment]]`.
11. If *targetEnv* is empty, throw a **ReferenceError** exception.
12. Return ? *targetEnv*.`GetBindingValue(binding.[[BindingName]], true)`.

**NOTE** `ResolveExport` is side-effect free. Each time this operation is called with a specific *exportName*, *resolveSet* pair as arguments it must return the same result. An implementation might choose to pre-compute or cache the `ResolveExport` results for the `[[Exports]]` of each [module namespace exotic object](#).



#### 10.4.6.9 `[[Set]]` ( *P*, *V*, *Receiver* )

The `[[Set]]` internal method of a [module namespace exotic object](#) takes arguments *P* (a [property key](#)), *V* (an [ECMAScript language value](#)), and *Receiver* (an [ECMAScript language value](#)) and returns a [normal completion containing false](#). It performs the following steps when called:

1. Return **false**.

#### 10.4.6.10 `[[Delete]]` ( *P* )

The `[[Delete]]` internal method of a [module namespace exotic object](#) *O* takes argument *P* (a [property key](#)) and returns a [normal completion containing](#) a Boolean. It performs the following steps when called:

1. If *P* is a [Symbol](#), then
  - a. Return ! `OrdinaryDelete`(*O*, *P*).
2. Let *exports* be *O*.[`[[Exports]]`].
3. If *exports* contains *P*, return **false**.
4. Return **true**.

#### 10.4.6.11 `[[OwnPropertyKeys]]` ( )

The `[[OwnPropertyKeys]]` internal method of a [module namespace exotic object](#) *O* takes no arguments and returns a [normal completion containing](#) a [List](#) of [property keys](#). It performs the following steps when called:

1. Let *exports* be *O*.[`[[Exports]]`].
2. Let *symbolKeys* be `OrdinaryOwnPropertyKeys`(*O*).
3. Return the [list-concatenation](#) of *exports* and *symbolKeys*.

#### 10.4.6.12 `ModuleNamespaceCreate` ( *module*, *exports* )

The abstract operation `ModuleNamespaceCreate` takes arguments *module* (a [Module Record](#)) and *exports* (a [List](#) of [Strings](#)) and returns a [module namespace exotic object](#). It is used to specify the creation of new [module namespace exotic objects](#). It performs the following steps when called:

1. **Assert**: *module*.[`[[Namespace]]`] is empty.
2. Let *internalSlotsList* be the internal slots listed in [Table 32](#).
3. Let *M* be `MakeBasicObject`(*internalSlotsList*).
4. Set *M*'s essential internal methods to the definitions specified in [10.4.6](#).
5. Set *M*.[`[[Module]]`] to *module*.
6. Let *sortedExports* be a [List](#) whose elements are the elements of *exports* ordered as if an [Array](#) of the same values had been sorted using `%Array.prototype.sort%` using **undefined** as *comparefn*.
7. Set *M*.[`[[Exports]]`] to *sortedExports*.
8. Create own properties of *M* corresponding to the definitions in [28.3](#).
9. Set *module*.[`[[Namespace]]`] to *M*.
10. Return *M*.

### 10.4.7 Immutable Prototype Exotic Objects

An [immutable prototype exotic object](#) is an [exotic object](#) that has a `[[Prototype]]` internal slot that will not change once it is initialized.

An object is an *immutable prototype exotic object* if its `[[SetPrototypeOf]]` internal method uses the following implementation. (Its other essential internal methods may use any implementation, depending on the specific *immutable prototype exotic object* in question.)

**NOTE** Unlike other *exotic objects*, there is not a dedicated creation abstract operation provided for *immutable prototype exotic objects*. This is because they are only used by `%Object.prototype%` and by *host environments*, and in *host environments*, the relevant objects are potentially exotic in other ways and thus need their own dedicated creation operation.

#### 10.4.7.1 `[[SetPrototypeOf]]` ( *V* )

The `[[SetPrototypeOf]]` internal method of an *immutable prototype exotic object* *O* takes argument *V* (an Object or `null`) and returns either a *normal completion containing* a Boolean or a *throw completion*. It performs the following steps when called:

1. Return ? `SetImmutablePrototype(O, V)`.

#### 10.4.7.2 `SetImmutablePrototype` ( *O*, *V* )

The abstract operation `SetImmutablePrototype` takes arguments *O* (an Object) and *V* (an Object or `null`) and returns either a *normal completion containing* a Boolean or a *throw completion*. It performs the following steps when called:

1. Let *current* be ? `O.[[GetPrototypeOf]]()`.
2. If `SameValue(V, current)` is `true`, return `true`.
3. Return `false`.

### 10.5 Proxy Object Internal Methods and Internal Slots

A Proxy object is an *exotic object* whose essential internal methods are partially implemented using ECMAScript code. Every Proxy object has an internal slot called `[[ProxyHandler]]`. The value of `[[ProxyHandler]]` is an object, called the proxy's *handler object*, or `null`. Methods (see [Table 33](#)) of a handler object may be used to augment the implementation for one or more of the Proxy object's internal methods. Every Proxy object also has an internal slot called `[[ProxyTarget]]` whose value is either an object or the `null` value. This object is called the proxy's *target object*.

An object is a *Proxy exotic object* if its essential internal methods (including `[[Call]]` and `[[Construct]]`, if applicable) use the definitions in this section. These internal methods are installed in [ProxyCreate](#).

**Table 33: Proxy Handler Methods**

Internal Method	Handler Method
<code>[[GetPrototypeOf]]</code>	<code>getPrototypeOf</code>
<code>[[SetPrototypeOf]]</code>	<code>setPrototypeOf</code>
<code>[[IsExtensible]]</code>	<code>isExtensible</code>
<code>[[PreventExtensions]]</code>	<code>preventExtensions</code>
<code>[[GetOwnProperty]]</code>	<code>getOwnPropertyDescriptor</code>
<code>[[DefineOwnProperty]]</code>	<code>defineProperty</code>
<code>[[HasProperty]]</code>	<code>has</code>

Table NN (continued)

Internal Method	Handler Method
[[Get]]	get
[[Set]]	set
[[Delete]]	deleteProperty
[[OwnPropertyKeys]]	ownKeys
[[Call]]	apply
[[Construct]]	construct

When a handler method is called to provide the implementation of a Proxy object internal method, the handler method is passed the proxy's target object as a parameter. A proxy's handler object does not necessarily have a method corresponding to every essential internal method. Invoking an internal method on the proxy results in the invocation of the corresponding internal method on the proxy's target object if the handler object does not have a method corresponding to the internal trap.

The [[ProxyHandler]] and [[ProxyTarget]] internal slots of a Proxy object are always initialized when the object is created and typically may not be modified. Some Proxy objects are created in a manner that permits them to be subsequently *revoked*. When a proxy is revoked, its [[ProxyHandler]] and [[ProxyTarget]] internal slots are set to **null** causing subsequent invocations of internal methods on that Proxy object to throw a **TypeError** exception.

Because Proxy objects permit the implementation of internal methods to be provided by arbitrary ECMAScript code, it is possible to define a Proxy object whose handler methods violates the invariants defined in 6.1.7.3. Some of the internal method invariants defined in 6.1.7.3 are essential integrity invariants. These invariants are explicitly enforced by the Proxy object internal methods specified in this section. An ECMAScript implementation must be robust in the presence of all possible invariant violations.

In the following algorithm descriptions, assume *O* is an ECMAScript Proxy object, *P* is a [property key](#) value, *V* is any [ECMAScript language value](#) and *Desc* is a [Property Descriptor](#) record.

### 10.5.1 [[GetPrototypeOf]] ( )

The [[GetPrototypeOf]] internal method of a [Proxy exotic object](#) *O* takes no arguments and returns either a [normal completion containing](#) either an Object or **null**, or a [throw completion](#). It performs the following steps when called:

1. Perform ? [ValidateNonRevokedProxy](#)(*O*).
2. Let *target* be *O*.[[ProxyTarget]].
3. Let *handler* be *O*.[[ProxyHandler]].
4. **Assert**: *handler* is an Object.
5. Let *trap* be ? [GetMethod](#)(*handler*, "getPrototypeOf").
6. If *trap* is **undefined**, then
  - a. Return ? *target*.[[GetPrototypeOf]]().
7. Let *handlerProto* be ? [Call](#)(*trap*, *handler*, « *target* »).
8. If *handlerProto* is not an Object and *handlerProto* is not **null**, throw a **TypeError** exception.
9. Let *extensibleTarget* be ? [IsExtensible](#)(*target*).
10. If *extensibleTarget* is **true**, return *handlerProto*.
11. Let *targetProto* be ? *target*.[[GetPrototypeOf]]().
12. If [SameValue](#)(*handlerProto*, *targetProto*) is **false**, throw a **TypeError** exception.
13. Return *handlerProto*.

NOTE `[[GetPrototypeOf]]` for Proxy objects enforces the following invariants:

- The result of `[[GetPrototypeOf]]` must be either an Object or **null**.
- If the target object is not extensible, `[[GetPrototypeOf]]` applied to the Proxy object must return the same value as `[[GetPrototypeOf]]` applied to the Proxy object's target object.

### 10.5.2 `[[SetPrototypeOf]]` ( *V* )

The `[[SetPrototypeOf]]` internal method of a Proxy exotic object *O* takes argument *V* (an Object or **null**) and returns either a normal completion containing a Boolean or a throw completion. It performs the following steps when called:

1. Perform ? `ValidateNonRevokedProxy(O)`.
2. Let *target* be *O*.`[[ProxyTarget]]`.
3. Let *handler* be *O*.`[[ProxyHandler]]`.
4. Assert: *handler* is an Object.
5. Let *trap* be ? `GetMethod(handler, "setPrototypeOf")`.
6. If *trap* is **undefined**, then
  - a. Return ? `target.[[SetPrototypeOf]](V)`.
7. Let *booleanTrapResult* be `ToBoolean(? Call(trap, handler, « target, V »))`.
8. If *booleanTrapResult* is **false**, return **false**.
9. Let *extensibleTarget* be ? `IsExtensible(target)`.
10. If *extensibleTarget* is **true**, return **true**.
11. Let *targetProto* be ? `target.[[GetPrototypeOf]]()`.
12. If `SameValue(V, targetProto)` is **false**, throw a **TypeError** exception.
13. Return **true**.

NOTE `[[SetPrototypeOf]]` for Proxy objects enforces the following invariants:

- The result of `[[SetPrototypeOf]]` is a Boolean value.
- If the target object is not extensible, the argument value must be the same as the result of `[[GetPrototypeOf]]` applied to target object.

### 10.5.3 `[[IsExtensible]]` ( )

The `[[IsExtensible]]` internal method of a Proxy exotic object *O* takes no arguments and returns either a normal completion containing a Boolean or a throw completion. It performs the following steps when called:

1. Perform ? `ValidateNonRevokedProxy(O)`.
2. Let *target* be *O*.`[[ProxyTarget]]`.
3. Let *handler* be *O*.`[[ProxyHandler]]`.
4. Assert: *handler* is an Object.
5. Let *trap* be ? `GetMethod(handler, "isExtensible")`.
6. If *trap* is **undefined**, then
  - a. Return ? `IsExtensible(target)`.
7. Let *booleanTrapResult* be `ToBoolean(? Call(trap, handler, « target »))`.
8. Let *targetResult* be ? `IsExtensible(target)`.
9. If `SameValue(booleanTrapResult, targetResult)` is **false**, throw a **TypeError** exception.
10. Return *booleanTrapResult*.

NOTE `[[IsExtensible]]` for Proxy objects enforces the following invariants:

- The result of `[[IsExtensible]]` is a Boolean value.
- `[[IsExtensible]]` applied to the Proxy object must return the same value as `[[IsExtensible]]` applied to the Proxy object's target object with the same argument.

#### 10.5.4 `[[PreventExtensions]]` ( )

The `[[PreventExtensions]]` internal method of a Proxy exotic object *O* takes no arguments and returns either a normal completion containing a Boolean or a throw completion. It performs the following steps when called:

1. Perform ? `ValidateNonRevokedProxy(O)`.
2. Let *target* be *O*.`[[ProxyTarget]]`.
3. Let *handler* be *O*.`[[ProxyHandler]]`.
4. Assert: *handler* is an Object.
5. Let *trap* be ? `GetMethod(handler, "preventExtensions")`.
6. If *trap* is **undefined**, then
  - a. Return ? *target*.`[[PreventExtensions]]()`.
7. Let *booleanTrapResult* be `ToBoolean(? Call(trap, handler, « target »))`.
8. If *booleanTrapResult* is **true**, then
  - a. Let *extensibleTarget* be ? `IsExtensible(target)`.
  - b. If *extensibleTarget* is **true**, throw a **TypeError** exception.
9. Return *booleanTrapResult*.

NOTE `[[PreventExtensions]]` for Proxy objects enforces the following invariants:

- The result of `[[PreventExtensions]]` is a Boolean value.
- `[[PreventExtensions]]` applied to the Proxy object only returns **true** if `[[IsExtensible]]` applied to the Proxy object's target object is **false**.

#### 10.5.5 `[[GetOwnProperty]]` ( *P* )

The `[[GetOwnProperty]]` internal method of a Proxy exotic object *O* takes argument *P* (a property key) and returns either a normal completion containing either a Property Descriptor or **undefined**, or a throw completion. It performs the following steps when called:

1. Perform ? `ValidateNonRevokedProxy(O)`.
2. Let *target* be *O*.`[[ProxyTarget]]`.
3. Let *handler* be *O*.`[[ProxyHandler]]`.
4. Assert: *handler* is an Object.
5. Let *trap* be ? `GetMethod(handler, "getOwnPropertyDescriptor")`.
6. If *trap* is **undefined**, then
  - a. Return ? *target*.`[[GetOwnProperty]](P)`.
7. Let *trapResultObj* be ? `Call(trap, handler, « target, P »)`.
8. If *trapResultObj* is not an Object and *trapResultObj* is not **undefined**, throw a **TypeError** exception.
9. Let *targetDesc* be ? *target*.`[[GetOwnProperty]](P)`.
10. If *trapResultObj* is **undefined**, then
  - a. If *targetDesc* is **undefined**, return **undefined**.
  - b. If *targetDesc*.`[[Configurable]]` is **false**, throw a **TypeError** exception.
  - c. Let *extensibleTarget* be ? `IsExtensible(target)`.
  - d. If *extensibleTarget* is **false**, throw a **TypeError** exception.

- e. Return **undefined**.
11. Let *extensibleTarget* be ? *IsExtensible*(*target*).
12. Let *resultDesc* be ? *ToPropertyDescriptor*(*trapResultObj*).
13. Perform *CompletePropertyDescriptor*(*resultDesc*).
14. Let *valid* be *IsCompatiblePropertyDescriptor*(*extensibleTarget*, *resultDesc*, *targetDesc*).
15. If *valid* is **false**, throw a **TypeError** exception.
16. If *resultDesc*.[[Configurable]] is **false**, then
  - a. If *targetDesc* is **undefined** or *targetDesc*.[[Configurable]] is **true**, then
    - i. Throw a **TypeError** exception.
  - b. If *resultDesc* has a [[Writable]] field and *resultDesc*.[[Writable]] is **false**, then
    - i. **Assert**: *targetDesc* has a [[Writable]] field.
    - ii. If *targetDesc*.[[Writable]] is **true**, throw a **TypeError** exception.
17. Return *resultDesc*.

NOTE [[GetOwnProperty]] for Proxy objects enforces the following invariants:

- The result of [[GetOwnProperty]] must be either an Object or **undefined**.
- A property cannot be reported as non-existent, if it exists as a non-configurable own property of the target object.
- A property cannot be reported as non-existent, if it exists as an own property of a non-extensible target object.
- A property cannot be reported as existent, if it does not exist as an own property of the target object and the target object is not extensible.
- A property cannot be reported as non-configurable, unless it exists as a non-configurable own property of the target object.
- A property cannot be reported as both non-configurable and non-writable, unless it exists as a non-configurable, non-writable own property of the target object.

### 10.5.6 [[DefineOwnProperty]] ( *P*, *Desc* )

The [[DefineOwnProperty]] internal method of a *Proxy* exotic object *O* takes arguments *P* (a *property key*) and *Desc* (a *Property Descriptor*) and returns either a *normal completion containing* a Boolean or a *throw completion*. It performs the following steps when called:

1. Perform ? *ValidateNonRevokedProxy*(*O*).
2. Let *target* be *O*.[[ProxyTarget]].
3. Let *handler* be *O*.[[ProxyHandler]].
4. **Assert**: *handler* is an Object.
5. Let *trap* be ? *GetMethod*(*handler*, "defineProperty").
6. If *trap* is **undefined**, then
  - a. Return ? *target*.[[DefineOwnProperty]](*P*, *Desc*).
7. Let *descObj* be *FromPropertyDescriptor*(*Desc*).
8. Let *booleanTrapResult* be *ToBoolean*(? *Call*(*trap*, *handler*, « *target*, *P*, *descObj* »)).
9. If *booleanTrapResult* is **false**, return **false**.
10. Let *targetDesc* be ? *target*.[[GetOwnProperty]](*P*).
11. Let *extensibleTarget* be ? *IsExtensible*(*target*).
12. If *Desc* has a [[Configurable]] field and *Desc*.[[Configurable]] is **false**, then
  - a. Let *settingConfigFalse* be **true**.
13. Else, let *settingConfigFalse* be **false**.
14. If *targetDesc* is **undefined**, then
  - a. If *extensibleTarget* is **false**, throw a **TypeError** exception.
  - b. If *settingConfigFalse* is **true**, throw a **TypeError** exception.
15. Else,

- a. If `IsCompatiblePropertyDescriptor(extensibleTarget, Desc, targetDesc)` is **false**, throw a **TypeError** exception.
  - b. If `settingConfigFalse` is **true** and `targetDesc.[[Configurable]]` is **true**, throw a **TypeError** exception.
  - c. If `IsDataDescriptor(targetDesc)` is **true**, `targetDesc.[[Configurable]]` is **false**, and `targetDesc.[[Writable]]` is **true**, then
    - i. If `Desc` has a `[[Writable]]` field and `Desc.[[Writable]]` is **false**, throw a **TypeError** exception.
16. Return **true**.

NOTE `[[DefineOwnProperty]]` for Proxy objects enforces the following invariants:

- The result of `[[DefineOwnProperty]]` is a Boolean value.
- A property cannot be added, if the target object is not extensible.
- A property cannot be non-configurable, unless there exists a corresponding non-configurable own property of the target object.
- A non-configurable property cannot be non-writable, unless there exists a corresponding non-configurable, non-writable own property of the target object.
- If a property has a corresponding target object property then applying the `PropertyDescriptor` of the property to the target object using `[[DefineOwnProperty]]` will not throw an exception.

### 10.5.7 `[[HasProperty]]` ( *P* )

The `[[HasProperty]]` internal method of a Proxy exotic object *O* takes argument *P* (a property key) and returns either a normal completion containing a Boolean or a throw completion. It performs the following steps when called:

1. Perform ? `ValidateNonRevokedProxy(O)`.
2. Let *target* be `O.[[ProxyTarget]]`.
3. Let *handler* be `O.[[ProxyHandler]]`.
4. Assert: *handler* is an Object.
5. Let *trap* be ? `GetMethod(handler, "has")`.
6. If *trap* is **undefined**, then
  - a. Return ? `target.[[HasProperty]](P)`.
7. Let *booleanTrapResult* be `ToBoolean(? Call(trap, handler, « target, P »))`.
8. If *booleanTrapResult* is **false**, then
  - a. Let *targetDesc* be ? `target.[[GetOwnProperty]](P)`.
  - b. If *targetDesc* is not **undefined**, then
    - i. If `targetDesc.[[Configurable]]` is **false**, throw a **TypeError** exception.
    - ii. Let *extensibleTarget* be ? `IsExtensible(target)`.
    - iii. If *extensibleTarget* is **false**, throw a **TypeError** exception.
9. Return *booleanTrapResult*.

NOTE `[[HasProperty]]` for Proxy objects enforces the following invariants:

- The result of `[[HasProperty]]` is a Boolean value.
- A property cannot be reported as non-existent, if it exists as a non-configurable own property of the target object.
- A property cannot be reported as non-existent, if it exists as an own property of the target object and the target object is not extensible.

### 10.5.8 `[[Get]]` ( *P*, *Receiver* )

The `[[Get]]` internal method of a [Proxy exotic object](#) *O* takes arguments *P* (a [property key](#)) and *Receiver* (an [ECMAScript language value](#)) and returns either a [normal completion](#) containing an [ECMAScript language value](#) or a [throw completion](#). It performs the following steps when called:

1. Perform ? [ValidateNonRevokedProxy](#)(*O*).
2. Let *target* be *O*.`[[ProxyTarget]]`.
3. Let *handler* be *O*.`[[ProxyHandler]]`.
4. **Assert**: *handler* is an [Object](#).
5. Let *trap* be ? [GetMethod](#)(*handler*, "get").
6. If *trap* is **undefined**, then
  - a. Return ? *target*.`[[Get]]`(*P*, *Receiver*).
7. Let *trapResult* be ? [Call](#)(*trap*, *handler*, « *target*, *P*, *Receiver* »).
8. Let *targetDesc* be ? *target*.`[[GetOwnProperty]]`(*P*).
9. If *targetDesc* is not **undefined** and *targetDesc*.`[[Configurable]]` is **false**, then
  - a. If [IsDataDescriptor](#)(*targetDesc*) is **true** and *targetDesc*.`[[Writable]]` is **false**, then
    - i. If [SameValue](#)(*trapResult*, *targetDesc*.`[[Value]]`) is **false**, throw a **TypeError** exception.
  - b. If [IsAccessorDescriptor](#)(*targetDesc*) is **true** and *targetDesc*.`[[Get]]` is **undefined**, then
    - i. If *trapResult* is not **undefined**, throw a **TypeError** exception.
10. Return *trapResult*.

NOTE `[[Get]]` for Proxy objects enforces the following invariants:

- The value reported for a property must be the same as the value of the corresponding target object property if the target object property is a non-writable, non-configurable own [data property](#).
- The value reported for a property must be **undefined** if the corresponding target object property is a non-configurable own [accessor property](#) that has **undefined** as its `[[Get]]` attribute.

### 10.5.9 `[[Set]]` ( *P*, *V*, *Receiver* )

The `[[Set]]` internal method of a [Proxy exotic object](#) *O* takes arguments *P* (a [property key](#)), *V* (an [ECMAScript language value](#)), and *Receiver* (an [ECMAScript language value](#)) and returns either a [normal completion](#) containing a [Boolean](#) or a [throw completion](#). It performs the following steps when called:

1. Perform ? [ValidateNonRevokedProxy](#)(*O*).
2. Let *target* be *O*.`[[ProxyTarget]]`.
3. Let *handler* be *O*.`[[ProxyHandler]]`.
4. **Assert**: *handler* is an [Object](#).
5. Let *trap* be ? [GetMethod](#)(*handler*, "set").
6. If *trap* is **undefined**, then
  - a. Return ? *target*.`[[Set]]`(*P*, *V*, *Receiver*).
7. Let *booleanTrapResult* be [ToBoolean](#)(? [Call](#)(*trap*, *handler*, « *target*, *P*, *V*, *Receiver* »)).
8. If *booleanTrapResult* is **false**, return **false**.
9. Let *targetDesc* be ? *target*.`[[GetOwnProperty]]`(*P*).
10. If *targetDesc* is not **undefined** and *targetDesc*.`[[Configurable]]` is **false**, then
  - a. If [IsDataDescriptor](#)(*targetDesc*) is **true** and *targetDesc*.`[[Writable]]` is **false**, then
    - i. If [SameValue](#)(*V*, *targetDesc*.`[[Value]]`) is **false**, throw a **TypeError** exception.
  - b. If [IsAccessorDescriptor](#)(*targetDesc*) is **true**, then



i. If *targetDesc*.[[Set]] is **undefined**, throw a **TypeError** exception.

11. Return **true**.

NOTE [[Set]] for Proxy objects enforces the following invariants:

- The result of [[Set]] is a Boolean value.
- Cannot change the value of a property to be different from the value of the corresponding target object property if the corresponding target object property is a non-writable, non-configurable own data property.
- Cannot set the value of a property if the corresponding target object property is a non-configurable own accessor property that has **undefined** as its [[Set]] attribute.

### 10.5.10 [[Delete]] ( P )

The [[Delete]] internal method of a Proxy exotic object *O* takes argument *P* (a property key) and returns either a normal completion containing a Boolean or a throw completion. It performs the following steps when called:

1. Perform ? *ValidateNonRevokedProxy*(*O*).
2. Let *target* be *O*.[[ProxyTarget]].
3. Let *handler* be *O*.[[ProxyHandler]].
4. Assert: *handler* is an Object.
5. Let *trap* be ? *GetMethod*(*handler*, "deleteProperty").
6. If *trap* is **undefined**, then
  - a. Return ? *target*.[[Delete]](*P*).
7. Let *booleanTrapResult* be *ToBoolean*(? *Call*(*trap*, *handler*, « *target*, *P* »)).
8. If *booleanTrapResult* is **false**, return **false**.
9. Let *targetDesc* be ? *target*.[[GetOwnProperty]](*P*).
10. If *targetDesc* is **undefined**, return **true**.
11. If *targetDesc*.[[Configurable]] is **false**, throw a **TypeError** exception.
12. Let *extensibleTarget* be ? *IsExtensible*(*target*).
13. If *extensibleTarget* is **false**, throw a **TypeError** exception.
14. Return **true**.

NOTE [[Delete]] for Proxy objects enforces the following invariants:

- The result of [[Delete]] is a Boolean value.
- A property cannot be reported as deleted, if it exists as a non-configurable own property of the target object.
- A property cannot be reported as deleted, if it exists as an own property of the target object and the target object is non-extensible.

### 10.5.11 [[OwnPropertyKeys]] ( )

The [[OwnPropertyKeys]] internal method of a Proxy exotic object *O* takes no arguments and returns either a normal completion containing a List of property keys or a throw completion. It performs the following steps when called:

1. Perform ? *ValidateNonRevokedProxy*(*O*).
2. Let *target* be *O*.[[ProxyTarget]].
3. Let *handler* be *O*.[[ProxyHandler]].
4. Assert: *handler* is an Object.

5. Let *trap* be ? *GetMethod(handler, "ownKeys")*.
6. If *trap* is **undefined**, then
  - a. Return ? *target*.*[[OwnPropertyKeys]]*()
7. Let *trapResultArray* be ? *Call(trap, handler, « target »)*.
8. Let *trapResult* be ? *CreateListFromArrayLike(trapResultArray, « String, Symbol »)*.
9. If *trapResult* contains any duplicate entries, throw a **TypeError** exception.
10. Let *extensibleTarget* be ? *IsExtensible(target)*.
11. Let *targetKeys* be ? *target*.*[[OwnPropertyKeys]]*()
12. **Assert**: *targetKeys* is a *List* of *property keys*.
13. **Assert**: *targetKeys* contains no duplicate entries.
14. Let *targetConfigurableKeys* be a new empty *List*.
15. Let *targetNonconfigurableKeys* be a new empty *List*.
16. For each element *key* of *targetKeys*, do
  - a. Let *desc* be ? *target*.*[[GetOwnProperty]]*(*key*).
  - b. If *desc* is not **undefined** and *desc*.*[[Configurable]]* is **false**, then
    - i. Append *key* to *targetNonconfigurableKeys*.
  - c. Else,
    - i. Append *key* to *targetConfigurableKeys*.
17. If *extensibleTarget* is **true** and *targetNonconfigurableKeys* is empty, then
  - a. Return *trapResult*.
18. Let *uncheckedResultKeys* be a *List* whose elements are the elements of *trapResult*.
19. For each element *key* of *targetNonconfigurableKeys*, do
  - a. If *uncheckedResultKeys* does not contain *key*, throw a **TypeError** exception.
  - b. Remove *key* from *uncheckedResultKeys*.
20. If *extensibleTarget* is **true**, return *trapResult*.
21. For each element *key* of *targetConfigurableKeys*, do
  - a. If *uncheckedResultKeys* does not contain *key*, throw a **TypeError** exception.
  - b. Remove *key* from *uncheckedResultKeys*.
22. If *uncheckedResultKeys* is not empty, throw a **TypeError** exception.
23. Return *trapResult*.

NOTE *[[OwnPropertyKeys]]* for Proxy objects enforces the following invariants:

- The result of *[[OwnPropertyKeys]]* is a *List*.
- The returned *List* contains no duplicate entries.
- The Type of each result *List* element is either String or Symbol.
- The result *List* must contain the keys of all non-configurable own properties of the target object.
- If the target object is not extensible, then the result *List* must contain all the keys of the own properties of the target object and no other values.

### 10.5.12 *[[Call]]* ( *thisArgument*, *argumentsList* )

The *[[Call]]* internal method of a Proxy exotic object *O* takes arguments *thisArgument* (an ECMAScript language value) and *argumentsList* (a *List* of ECMAScript language values) and returns either a normal completion containing an ECMAScript language value or a throw completion. It performs the following steps when called:

1. Perform ? *ValidateNonRevokedProxy(O)*.
2. Let *target* be *O*.*[[ProxyTarget]]*.
3. Let *handler* be *O*.*[[ProxyHandler]]*.
4. **Assert**: *handler* is an Object.
5. Let *trap* be ? *GetMethod(handler, "apply")*.

6. If *trap* is **undefined**, then
  - a. Return ? *Call*(*target*, *thisArgument*, *argumentsList*).
7. Let *argArray* be *CreateArrayFromList*(*argumentsList*).
8. Return ? *Call*(*trap*, *handler*, « *target*, *thisArgument*, *argArray* »).

NOTE A *Proxy exotic object* only has a `[[Call]]` internal method if the initial value of its `[[ProxyTarget]]` internal slot is an object that has a `[[Call]]` internal method.

### 10.5.13 `[[Construct]]` ( *argumentsList*, *newTarget* )

The `[[Construct]]` internal method of a *Proxy exotic object* *O* takes arguments *argumentsList* (a List of ECMAScript language values) and *newTarget* (a constructor) and returns either a normal completion containing an Object or a throw completion. It performs the following steps when called:

1. Perform ? *ValidateNonRevokedProxy*(*O*).
2. Let *target* be *O*.`[[ProxyTarget]]`.
3. **Assert**: *IsConstructor*(*target*) is **true**.
4. Let *handler* be *O*.`[[ProxyHandler]]`.
5. **Assert**: *handler* is an Object.
6. Let *trap* be ? *GetMethod*(*handler*, "construct").
7. If *trap* is **undefined**, then
  - a. Return ? *Construct*(*target*, *argumentsList*, *newTarget*).
8. Let *argArray* be *CreateArrayFromList*(*argumentsList*).
9. Let *newObj* be ? *Call*(*trap*, *handler*, « *target*, *argArray*, *newTarget* »).
10. If *newObj* is not an Object, throw a **TypeError** exception.
11. Return *newObj*.

NOTE 1 A *Proxy exotic object* only has a `[[Construct]]` internal method if the initial value of its `[[ProxyTarget]]` internal slot is an object that has a `[[Construct]]` internal method.

NOTE 2 `[[Construct]]` for Proxy objects enforces the following invariants:

- The result of `[[Construct]]` must be an Object.

### 10.5.14 *ValidateNonRevokedProxy* ( *proxy* )

The abstract operation *ValidateNonRevokedProxy* takes argument *proxy* (a *Proxy exotic object*) and returns either a normal completion containing **unused** or a throw completion. It throws a **TypeError** exception if *proxy* has been revoked. It performs the following steps when called:

1. If *proxy*.`[[ProxyTarget]]` is **null**, throw a **TypeError** exception.
2. **Assert**: *proxy*.`[[ProxyHandler]]` is not **null**.
3. Return **unused**.

### 10.5.15 *ProxyCreate* ( *target*, *handler* )

The abstract operation *ProxyCreate* takes arguments *target* (an ECMAScript language value) and *handler* (an ECMAScript language value) and returns either a normal completion containing a *Proxy exotic object* or a throw completion. It is used to specify the creation of new Proxy objects. It performs the following steps when called:

1. If *target* is not an Object, throw a **TypeError** exception.
2. If *handler* is not an Object, throw a **TypeError** exception.
3. Let *P* be `MakeBasicObject`(« `[[ProxyHandler]]`, `[[ProxyTarget]]` »).
4. Set *P*'s essential internal methods, except for `[[Call]]` and `[[Construct]]`, to the definitions specified in 10.5.
5. If `IsCallable`(*target*) is **true**, then
  - a. Set *P*.`[[Call]]` as specified in 10.5.12.
  - b. If `IsConstructor`(*target*) is **true**, then
    - i. Set *P*.`[[Construct]]` as specified in 10.5.13.
6. Set *P*.`[[ProxyTarget]]` to *target*.
7. Set *P*.`[[ProxyHandler]]` to *handler*.
8. Return *P*.

## 11 ECMAScript Language: Source Text

### 11.1 Source Text

#### Syntax

*SourceCharacter* ::  
any Unicode code point

*ECMAScript source text* is a sequence of Unicode code points. All Unicode code point values from U+0000 to U+10FFFF, including surrogate code points, may occur in ECMAScript source text where permitted by the ECMAScript grammars. The actual encodings used to store and interchange ECMAScript source text is not relevant to this specification. Regardless of the external source text encoding, a conforming ECMAScript implementation processes the source text as if it was an equivalent sequence of *SourceCharacter* values, each *SourceCharacter* being a Unicode code point. Conforming ECMAScript implementations are not required to perform any normalization of source text, or behave as though they were performing normalization of source text.

The components of a combining character sequence are treated as individual Unicode code points even though a user might think of the whole sequence as a single character.

**NOTE** In string literals, regular expression literals, template literals and identifiers, any Unicode code point may also be expressed using Unicode escape sequences that explicitly express a code point's numeric value. Within a comment, such an escape sequence is effectively ignored as part of the comment.

ECMAScript differs from the Java programming language in the behaviour of Unicode escape sequences. In a Java program, if the Unicode escape sequence `\u000A`, for example, occurs within a single-line comment, it is interpreted as a line terminator (Unicode code point U+000A is LINE FEED (LF)) and therefore the next code point is not part of the comment. Similarly, if the Unicode escape sequence `\u000A` occurs within a string literal in a Java program, it is likewise interpreted as a line terminator, which is not allowed within a string literal—one must write `\n` instead of `\u000A` to cause a LINE FEED (LF) to be part of the String value of a string literal. In an ECMAScript program, a Unicode escape sequence occurring within a comment is never interpreted and therefore cannot contribute to termination of the comment. Similarly, a Unicode escape sequence occurring within a string literal in an ECMAScript program always contributes to the literal and is never interpreted as a line terminator or as a code point that might terminate the string literal.

### 11.1.1 Static Semantics: UTF16EncodeCodePoint ( *cp* )

The abstract operation UTF16EncodeCodePoint takes argument *cp* (a Unicode code point) and returns a String. It performs the following steps when called:

1. **Assert:**  $0 \leq cp \leq 0x10FFFF$ .
2. If  $cp \leq 0xFFFF$ , return the String value consisting of the code unit whose numeric value is *cp*.
3. Let *cu1* be the code unit whose numeric value is  $\text{floor}((cp - 0x10000) / 0x400) + 0xD800$ .
4. Let *cu2* be the code unit whose numeric value is  $((cp - 0x10000) \bmod 0x400) + 0xDC00$ .
5. Return the **string-concatenation** of *cu1* and *cu2*.

### 11.1.2 Static Semantics: CodePointsToString ( *text* )

The abstract operation CodePointsToString takes argument *text* (a sequence of Unicode code points) and returns a String. It converts *text* into a String value, as described in 6.1.4. It performs the following steps when called:

1. Let *result* be the empty String.
2. For each code point *cp* of *text*, do
  - a. Set *result* to the **string-concatenation** of *result* and UTF16EncodeCodePoint(*cp*).
3. Return *result*.

### 11.1.3 Static Semantics: UTF16SurrogatePairToCodePoint ( *lead*, *trail* )

The abstract operation UTF16SurrogatePairToCodePoint takes arguments *lead* (a code unit) and *trail* (a code unit) and returns a code point. Two code units that form a UTF-16 **surrogate pair** are converted to a code point. It performs the following steps when called:

1. **Assert:** *lead* is a **leading surrogate** and *trail* is a **trailing surrogate**.
2. Let *cp* be  $(lead - 0xD800) \times 0x400 + (trail - 0xDC00) + 0x10000$ .
3. Return the code point *cp*.

### 11.1.4 Static Semantics: CodePointAt ( *string*, *position* )

The abstract operation CodePointAt takes arguments *string* (a String) and *position* (a non-negative **integer**) and returns a **Record** with fields **[[CodePoint]]** (a code point), **[[CodeUnitCount]]** (a positive **integer**), and **[[IsUnpairedSurrogate]]** (a Boolean). It interprets *string* as a sequence of UTF-16 encoded code points, as described in 6.1.4, and reads from it a single code point starting with the code unit at index *position*. It performs the following steps when called:

1. Let *size* be the length of *string*.
2. **Assert:**  $position \geq 0$  and  $position < size$ .
3. Let *first* be the code unit at index *position* within *string*.
4. Let *cp* be the code point whose numeric value is the numeric value of *first*.
5. If *first* is neither a **leading surrogate** nor a **trailing surrogate**, then
  - a. Return the **Record** { **[[CodePoint]]**: *cp*, **[[CodeUnitCount]]**: 1, **[[IsUnpairedSurrogate]]**: **false** }.
6. If *first* is a **trailing surrogate** or  $position + 1 = size$ , then
  - a. Return the **Record** { **[[CodePoint]]**: *cp*, **[[CodeUnitCount]]**: 1, **[[IsUnpairedSurrogate]]**: **true** }.
7. Let *second* be the code unit at index  $position + 1$  within *string*.
8. If *second* is not a **trailing surrogate**, then
  - a. Return the **Record** { **[[CodePoint]]**: *cp*, **[[CodeUnitCount]]**: 1, **[[IsUnpairedSurrogate]]**: **true** }.
9. Set *cp* to UTF16SurrogatePairToCodePoint(*first*, *second*).

10. Return the **Record** { **[[CodePoint]]**: *cp*, **[[CodeUnitCount]]**: 2, **[[IsUnpairedSurrogate]]**: **false** }.

### 11.1.5 Static Semantics: StringToCodePoints ( *string* )

The abstract operation StringToCodePoints takes argument *string* (a String) and returns a List of code points. It returns the sequence of Unicode code points that results from interpreting *string* as UTF-16 encoded Unicode text as described in 6.1.4. It performs the following steps when called:

1. Let *codePoints* be a new empty List.
2. Let *size* be the length of *string*.
3. Let *position* be 0.
4. Repeat, while *position* < *size*,
  - a. Let *cp* be CodePointAt(*string*, *position*).
  - b. Append *cp*.**[[CodePoint]]** to *codePoints*.
  - c. Set *position* to *position* + *cp*.**[[CodeUnitCount]].**
5. Return *codePoints*.

### 11.1.6 Static Semantics: ParseText ( *sourceText*, *goalSymbol* )

The abstract operation ParseText takes arguments *sourceText* (a sequence of Unicode code points) and *goalSymbol* (a nonterminal in one of the ECMAScript grammars) and returns a Parse Node or a non-empty List of **SyntaxError** objects. It performs the following steps when called:

1. Attempt to parse *sourceText* using *goalSymbol* as the goal symbol, and analyse the parse result for any early error conditions. Parsing and early error detection may be interleaved in an implementation-defined manner.
2. If the parse succeeded and no early errors were found, return the Parse Node (an instance of *goalSymbol*) at the root of the parse tree resulting from the parse.
3. Otherwise, return a List of one or more **SyntaxError** objects representing the parsing errors and/or early errors. If more than one parsing error or early error is present, the number and ordering of error objects in the list is implementation-defined, but at least one must be present.

NOTE 1 Consider a text that has an early error at a particular point, and also a syntax error at a later point. An implementation that does a parse pass followed by an early errors pass might report the syntax error and not proceed to the early errors pass. An implementation that interleaves the two activities might report the early error and not proceed to find the syntax error. A third implementation might report both errors. All of these behaviours are conformant.

NOTE 2 See also clause 17.

## 11.2 Types of Source Code

There are four types of ECMAScript code:

- *Global code* is source text that is treated as an ECMAScript *Script*. The global code of a particular *Script* does not include any source text that is parsed as part of a *FunctionDeclaration*, *FunctionExpression*, *GeneratorDeclaration*, *GeneratorExpression*, *AsyncFunctionDeclaration*, *AsyncFunctionExpression*, *AsyncGeneratorDeclaration*, *AsyncGeneratorExpression*, *MethodDefinition*, *ArrowFunction*, *AsyncArrowFunction*, *ClassDeclaration*, or *ClassExpression*.
- *Eval code* is the source text supplied to the built-in **eval** function. More precisely, if the parameter to the built-in **eval** function is a String, it is treated as an ECMAScript *Script*. The eval code for a particular invocation of **eval** is the global code portion of that *Script*.

- *Function code* is source text that is parsed to supply the value of the `[[ECMAScriptCode]]` and `[[FormalParameters]]` internal slots (see 10.2) of an ECMAScript *function object*. The function code of a particular ECMAScript function does not include any source text that is parsed as the function code of a nested *FunctionDeclaration*, *FunctionExpression*, *GeneratorDeclaration*, *GeneratorExpression*, *AsyncFunctionDeclaration*, *AsyncFunctionExpression*, *AsyncGeneratorDeclaration*, *AsyncGeneratorExpression*, *MethodDefinition*, *ArrowFunction*, *AsyncArrowFunction*, *ClassDeclaration*, or *ClassExpression*.

In addition, if the source text referred to above is parsed as:

- the *FormalParameters* and *FunctionBody* of a *FunctionDeclaration* or *FunctionExpression*,
- the *FormalParameters* and *GeneratorBody* of a *GeneratorDeclaration* or *GeneratorExpression*,
- the *FormalParameters* and *AsyncFunctionBody* of an *AsyncFunctionDeclaration* or *AsyncFunctionExpression*, or
- the *FormalParameters* and *AsyncGeneratorBody* of an *AsyncGeneratorDeclaration* or *AsyncGeneratorExpression*,

then the *source text matched by* the *BindingIdentifier* (if any) of that declaration or expression is also included in the function code of the corresponding function.

- *Module code* is source text that is code that is provided as a *ModuleBody*. It is the code that is directly evaluated when a module is initialized. The module code of a particular module does not include any source text that is parsed as part of a nested *FunctionDeclaration*, *FunctionExpression*, *GeneratorDeclaration*, *GeneratorExpression*, *AsyncFunctionDeclaration*, *AsyncFunctionExpression*, *AsyncGeneratorDeclaration*, *AsyncGeneratorExpression*, *MethodDefinition*, *ArrowFunction*, *AsyncArrowFunction*, *ClassDeclaration*, or *ClassExpression*.

NOTE 1 Function code is generally provided as the bodies of Function Definitions (15.2), Arrow Function Definitions (15.3), Method Definitions (15.4), Generator Function Definitions (15.5), Async Function Definitions (15.8), Async Generator Function Definitions (15.6), and Async Arrow Functions (15.9). Function code is also derived from the arguments to the Function constructor (20.2.1.1), the GeneratorFunction constructor (27.3.1.1), and the AsyncFunction constructor (27.7.1.1).

NOTE 2 The practical effect of including the *BindingIdentifier* in function code is that the Early Errors for *strict mode code* are applied to a *BindingIdentifier* that is the name of a function whose body contains a "use strict" directive, even if the surrounding code is not *strict mode code*.

### 11.2.1 Directive Prologues and the Use Strict Directive

A *Directive Prologue* is the longest sequence of *ExpressionStatements* occurring as the initial *StatementListItem*s or *ModuleItem*s of a *FunctionBody*, a *ScriptBody*, or a *ModuleBody* and where each *ExpressionStatement* in the sequence consists entirely of a *StringLiteral* token followed by a semicolon. The semicolon may appear explicitly or may be inserted by automatic semicolon insertion (12.10). A *Directive Prologue* may be an empty sequence.

A *Use Strict Directive* is an *ExpressionStatement* in a *Directive Prologue* whose *StringLiteral* is either of the exact code point sequences "use strict" or 'use strict'. A *Use Strict Directive* may not contain an *EscapeSequence* or *LineContinuation*.

A *Directive Prologue* may contain more than one *Use Strict Directive*. However, an implementation may issue a warning if this occurs.

**NOTE** The *ExpressionStatements* of a [Directive Prologue](#) are evaluated normally during evaluation of the containing production. Implementations may define implementation specific meanings for *ExpressionStatements* which are not a [Use Strict Directive](#) and which occur in a [Directive Prologue](#). If an appropriate notification mechanism exists, an implementation should issue a warning if it encounters in a [Directive Prologue](#) an *ExpressionStatement* that is not a [Use Strict Directive](#) and which does not have a meaning defined by the implementation.

### 11.2.2 Strict Mode Code

An ECMAScript syntactic unit may be processed using either unrestricted or strict mode syntax and semantics (4.3.2). Code is interpreted as *strict mode code* in the following situations:

- [Global code](#) is strict mode code if it begins with a [Directive Prologue](#) that contains a [Use Strict Directive](#).
- [Module code](#) is always strict mode code.
- All parts of a *ClassDeclaration* or a *ClassExpression* are strict mode code.
- [Eval code](#) is strict mode code if it begins with a [Directive Prologue](#) that contains a [Use Strict Directive](#) or if the call to `eval` is a [direct eval](#) that is contained in strict mode code.
- [Function code](#) is strict mode code if the associated *FunctionDeclaration*, *FunctionExpression*, *GeneratorDeclaration*, *GeneratorExpression*, *AsyncFunctionDeclaration*, *AsyncFunctionExpression*, *AsyncGeneratorDeclaration*, *AsyncGeneratorExpression*, *MethodDefinition*, *ArrowFunction*, or *AsyncArrowFunction* is contained in strict mode code or if the code that produces the value of the function's `[[ECMAScriptCode]]` internal slot begins with a [Directive Prologue](#) that contains a [Use Strict Directive](#).
- [Function code](#) that is supplied as the arguments to the built-in `Function`, `Generator`, `AsyncFunction`, and `AsyncGenerator` [constructors](#) is strict mode code if the last argument is a [String](#) that when processed is a *FunctionBody* that begins with a [Directive Prologue](#) that contains a [Use Strict Directive](#).

ECMAScript code that is not strict mode code is called *non-strict code*.

### 11.2.3 Non-ECMAScript Functions

An ECMAScript implementation may support the evaluation of function [exotic objects](#) whose evaluative behaviour is expressed in some [host-defined](#) form of executable code other than [ECMAScript source text](#). Whether a [function object](#) is defined within ECMAScript code or is a built-in function is not observable from the perspective of ECMAScript code that calls or is called by such a [function object](#).

## 12 ECMAScript Language: Lexical Grammar

The source text of an ECMAScript *Script* or *Module* is first converted into a sequence of input elements, which are tokens, line terminators, comments, or white space. The source text is scanned from left to right, repeatedly taking the longest possible sequence of code points as the next input element.

There are several situations where the identification of lexical input elements is sensitive to the syntactic grammar context that is consuming the input elements. This requires multiple [goal symbols](#) for the lexical grammar. The *InputElementHashbangOrRegExp* goal is used at the start of a *Script* or *Module*. The *InputElementRegExpOrTemplateTail* goal is used in syntactic grammar contexts where a *RegularExpressionLiteral*, a *TemplateMiddle*, or a *TemplateTail* is permitted. The *InputElementRegExp* [goal symbol](#) is used in all syntactic grammar contexts where a *RegularExpressionLiteral* is permitted but neither a *TemplateMiddle*, nor a *TemplateTail* is permitted. The *InputElementTemplateTail* goal is used in all syntactic grammar contexts where a *TemplateMiddle* or a *TemplateTail* is permitted but a *RegularExpressionLiteral* is not permitted. In all other contexts, *InputElementDiv* is used as the lexical [goal symbol](#).



NOTE The use of multiple lexical goals ensures that there are no lexical ambiguities that would affect automatic semicolon insertion. For example, there are no syntactic grammar contexts where both a leading division or division-assignment, and a leading *RegularExpressionLiteral* are permitted. This is not affected by semicolon insertion (see 12.10); in examples such as the following:

```
a = b  
/hi/g.exec(c).map(d);
```

where the first non-whitespace, non-comment code point after a *LineTerminator* is U+002F (SOLIDUS) and the syntactic context allows division or division-assignment, no semicolon is inserted at the *LineTerminator*. That is, the above example is interpreted in the same way as:

```
a = b / hi / g.exec(c).map(d);
```

## Syntax

```
InputElementDiv ::  
  WhiteSpace  
  LineTerminator  
  Comment  
  CommonToken  
  DivPunctuator  
  RightBracePunctuator
```

```
InputElementRegExp ::  
  WhiteSpace  
  LineTerminator  
  Comment  
  CommonToken  
  RightBracePunctuator  
  RegularExpressionLiteral
```

```
InputElementRegExpOrTemplateTail ::  
  WhiteSpace  
  LineTerminator  
  Comment  
  CommonToken  
  RegularExpressionLiteral  
  TemplateSubstitutionTail
```

```
InputElementTemplateTail ::  
  WhiteSpace  
  LineTerminator  
  Comment  
  CommonToken  
  DivPunctuator  
  TemplateSubstitutionTail
```

```
InputElementHashbangOrRegExp ::  
  WhiteSpace  
  LineTerminator  
  Comment  
  CommonToken  
  HashbangComment  
  RegularExpressionLiteral
```

## 12.1 Unicode Format-Control Characters

The Unicode format-control characters (i.e., the characters in category “Cf” in the Unicode Character Database such as LEFT-TO-RIGHT MARK or RIGHT-TO-LEFT MARK) are control codes used to control the formatting of a range of text in the absence of higher-level protocols for this (such as mark-up languages).

It is useful to allow format-control characters in source text to facilitate editing and display. All format control characters may be used within comments, and within string literals, template literals, and regular expression literals.

U+200C (ZERO WIDTH NON-JOINER) and U+200D (ZERO WIDTH JOINER) are format-control characters that are used to make necessary distinctions when forming words or phrases in certain languages. In [ECMAScript source text](#) these code points may also be used in an *IdentifierName* after the first character.

U+FEFF (ZERO WIDTH NO-BREAK SPACE) is a format-control character used primarily at the start of a text to mark it as Unicode and to allow detection of the text's encoding and byte order. <ZWNBSP> characters intended for this purpose can sometimes also appear after the start of a text, for example as a result of concatenating files. In [ECMAScript source text](#) <ZWNBSP> code points are treated as white space characters (see [12.2](#)).

The special treatment of certain format-control characters outside of comments, string literals, and regular expression literals is summarized in [Table 34](#).

**Table 34: Format-Control Code Point Usage**

Code Point	Name	Abbreviation	Usage
U+200C	ZERO WIDTH NON-JOINER	<ZWNJ>	<i>IdentifierPart</i>
U+200D	ZERO WIDTH JOINER	<ZWJ>	<i>IdentifierPart</i>
U+FEFF	ZERO WIDTH NO-BREAK SPACE	<ZWNBSP>	<i>WhiteSpace</i>

## 12.2 White Space

White space code points are used to improve source text readability and to separate tokens (indivisible lexical units) from each other, but are otherwise insignificant. White space code points may occur between any two tokens and at the start or end of input. White space code points may occur within a *StringLiteral*, a *RegularExpressionLiteral*, a *Template*, or a *TemplateSubstitutionTail* where they are considered significant code points forming part of a literal value. They may also occur within a *Comment*, but cannot appear within any other kind of token.

The ECMAScript white space code points are listed in [Table 35](#).

**Table 35: White Space Code Points**

Code Points	Name	Abbreviation
U+0009	CHARACTER TABULATION	<TAB>
U+000B	LINE TABULATION	<VT>
U+000C	FORM FEED (FF)	<FF>
U+FEFF	ZERO WIDTH NO-BREAK SPACE	<ZWNBSP>
any code point in general category “Space_Separator”		<USP>

NOTE 1 U+0020 (SPACE) and U+00A0 (NO-BREAK SPACE) code points are part of <USP>.

NOTE 2 Other than for the code points listed in [Table 35](#), ECMAScript *WhiteSpace* intentionally excludes all code points that have the Unicode “White\_Space” property but which are not classified in general category “Space\_Separator” (“Zs”).

## Syntax

```
WhiteSpace ::
    <TAB>
    <VT>
    <FF>
    <ZWNBSP>
    <USP>
```

## 12.3 Line Terminators

Like white space code points, line terminator code points are used to improve source text readability and to separate tokens (indivisible lexical units) from each other. However, unlike white space code points, line terminators have some influence over the behaviour of the syntactic grammar. In general, line terminators may occur between any two tokens, but there are a few places where they are forbidden by the syntactic grammar. Line terminators also affect the process of automatic semicolon insertion ([12.10](#)). A line terminator cannot occur within any token except a *StringLiteral*, *Template*, or *TemplateSubstitutionTail*. <LF> and <CR> line terminators cannot occur within a *StringLiteral* token except as part of a *LineContinuation*.

A line terminator can occur within a *MultiLineComment* but cannot occur within a *SingleLineComment*.

Line terminators are included in the set of white space code points that are matched by the `\s` class in regular expressions.

The ECMAScript line terminator code points are listed in [Table 36](#).

**Table 36: Line Terminator Code Points**

Code Point	Unicode Name	Abbreviation
U+000A	LINE FEED (LF)	<LF>
U+000D	CARRIAGE RETURN (CR)	<CR>
U+2028	LINE SEPARATOR	<LS>
U+2029	PARAGRAPH SEPARATOR	<PS>

Only the Unicode code points in [Table 36](#) are treated as line terminators. Other new line or line breaking Unicode code points are not treated as line terminators but are treated as white space if they meet the requirements listed in [Table 35](#). The sequence <CR><LF> is commonly used as a line terminator. It should be considered a single *SourceCharacter* for the purpose of reporting line numbers.

## Syntax

```
LineTerminator ::
    <LF>
    <CR>
    <LS>
```

<PS>

*LineTerminatorSequence* ::

<LF>

<CR> [lookahead ≠ <LF>]

<LS>

<PS>

<CR> <LF>

## 12.4 Comments

Comments can be either single or multi-line. Multi-line comments cannot nest.

Because a single-line comment can contain any Unicode code point except a *LineTerminator* code point, and because of the general rule that a token is always as long as possible, a single-line comment always consists of all code points from the *//* marker to the end of the line. However, the *LineTerminator* at the end of the line is not considered to be part of the single-line comment; it is recognized separately by the lexical grammar and becomes part of the stream of input elements for the syntactic grammar. This point is very important, because it implies that the presence or absence of single-line comments does not affect the process of automatic semicolon insertion (see 12.10).

Comments behave like white space and are discarded except that, if a *MultiLineComment* contains a line terminator code point, then the entire comment is considered to be a *LineTerminator* for purposes of parsing by the syntactic grammar.

### Syntax

*Comment* ::

*MultiLineComment*

*SingleLineComment*

*MultiLineComment* ::

*/\* MultiLineCommentChars<sub>opt</sub> \*/*

*MultiLineCommentChars* ::

*MultiLineNotAsteriskChar MultiLineCommentChars<sub>opt</sub>*

*\* PostAsteriskCommentChars<sub>opt</sub>*

*PostAsteriskCommentChars* ::

*MultiLineNotForwardSlashOrAsteriskChar MultiLineCommentChars<sub>opt</sub>*

*\* PostAsteriskCommentChars<sub>opt</sub>*

*MultiLineNotAsteriskChar* ::

*SourceCharacter* but not *\**

*MultiLineNotForwardSlashOrAsteriskChar* ::

*SourceCharacter* but not one of */* or *\**

*SingleLineComment* ::

*// SingleLineCommentChars<sub>opt</sub>*

*SingleLineCommentChars* ::

*SingleLineCommentChar SingleLineCommentChars<sub>opt</sub>*

*SingleLineCommentChar* ::

*SourceCharacter* but not *LineTerminator*

A number of productions in this section are given alternative definitions in section [B.1.1](#)

## 12.5 Hashbang Comments

Hashbang Comments are location-sensitive and like other types of comments are discarded from the stream of input elements for the syntactic grammar.

### Syntax

```
HashbangComment ::  
    #! SingleLineCommentCharsopt
```

## 12.6 Tokens

### Syntax

```
CommonToken ::  
    IdentifierName  
    PrivateIdentifier  
    Punctuator  
    NumericLiteral  
    StringLiteral  
    Template
```

**NOTE** The *DivPunctuator*, *RegularExpressionLiteral*, *RightBracePunctuator*, and *TemplateSubstitutionTail* productions derive additional tokens that are not included in the *CommonToken* production.

## 12.7 Names and Keywords

*IdentifierName* and *ReservedWord* are tokens that are interpreted according to the Default Identifier Syntax given in Unicode Standard Annex #31, Identifier and Pattern Syntax, with some small modifications. *ReservedWord* is an enumerated subset of *IdentifierName*. The syntactic grammar defines *Identifier* as an *IdentifierName* that is not a *ReservedWord*. The Unicode identifier grammar is based on character properties specified by the Unicode Standard. The Unicode code points in the specified categories in the latest version of the Unicode Standard must be treated as in those categories by all conforming ECMAScript implementations. ECMAScript implementations may recognize identifier code points defined in later editions of the Unicode Standard.

**NOTE 1** This standard specifies specific code point additions: U+0024 (DOLLAR SIGN) and U+005F (LOW LINE) are permitted anywhere in an *IdentifierName*, and the code points U+200C (ZERO WIDTH NON-JOINER) and U+200D (ZERO WIDTH JOINER) are permitted anywhere after the first code point of an *IdentifierName*.

### Syntax

```
PrivateIdentifier ::  
    # IdentifierName  
  
IdentifierName ::  
    IdentifierStart  
    IdentifierName IdentifierPart
```

```
IdentifierStart ::
    IdentifierStartChar
    \ UnicodeEscapeSequence
```

```
IdentifierPart ::
    IdentifierPartChar
    \ UnicodeEscapeSequence
```

```
IdentifierStartChar ::
    UnicodeIDStart
    $
    -
```

```
IdentifierPartChar ::
    UnicodeIDContinue
    $
    <ZWJ>
    <ZWJ>
```

```
AsciiLetter :: one of
    a b c d e f g h i j k l m n o p q r s t u v w x y z A B C D E F G H I J K L
    M N O P Q R S T U V W X Y Z
```

```
UnicodeIDStart ::
    any Unicode code point with the Unicode property "ID_Start"
```

```
UnicodeIDContinue ::
    any Unicode code point with the Unicode property "ID_Continue"
```

The definitions of the nonterminal *UnicodeEscapeSequence* is given in [12.9.4](#).

NOTE 2 The nonterminal *IdentifierPart* derives `_` via *UnicodeIDContinue*.

NOTE 3 The sets of code points with Unicode properties "ID\_Start" and "ID\_Continue" include, respectively, the code points with Unicode properties "Other\_ID\_Start" and "Other\_ID\_Continue".

## 12.7.1 Identifier Names

Unicode escape sequences are permitted in an *IdentifierName*, where they contribute a single Unicode code point equal to the [IdentifierCodePoint](#) of the *UnicodeEscapeSequence*. The `\` preceding the *UnicodeEscapeSequence* does not contribute any code points. A *UnicodeEscapeSequence* cannot be used to contribute a code point to an *IdentifierName* that would otherwise be invalid. In other words, if a `\ UnicodeEscapeSequence` sequence were replaced by the *SourceCharacter* it contributes, the result must still be a valid *IdentifierName* that has the exact same sequence of *SourceCharacter* elements as the original *IdentifierName*. All interpretations of *IdentifierName* within this specification are based upon their actual code points regardless of whether or not an escape sequence was used to contribute any particular code point.

Two *IdentifierNames* that are canonically equivalent according to the Unicode Standard are *not* equal unless, after replacement of each *UnicodeEscapeSequence*, they are represented by the exact same sequence of code points.

### 12.7.1.1 Static Semantics: Early Errors

```
IdentifierStart :: \ UnicodeEscapeSequence
```

- It is a Syntax Error if `IdentifierCodePoint` of `UnicodeEscapeSequence` is not some Unicode code point matched by the `IdentifierStartChar` lexical grammar production.

`IdentifierPart` :: `\ UnicodeEscapeSequence`

- It is a Syntax Error if `IdentifierCodePoint` of `UnicodeEscapeSequence` is not some Unicode code point matched by the `IdentifierPartChar` lexical grammar production.

### 12.7.1.2 Static Semantics: IdentifierCodePoints

The [syntax-directed operation](#) `IdentifierCodePoints` takes no arguments and returns a [List](#) of code points. It is defined piecewise over the following productions:

`IdentifierName` :: `IdentifierStart`

1. Let `cp` be `IdentifierCodePoint` of `IdentifierStart`.
2. Return « `cp` ».

`IdentifierName` :: `IdentifierName IdentifierPart`

1. Let `cps` be `IdentifierCodePoints` of the derived `IdentifierName`.
2. Let `cp` be `IdentifierCodePoint` of `IdentifierPart`.
3. Return the [list-concatenation](#) of `cps` and « `cp` ».

### 12.7.1.3 Static Semantics: IdentifierCodePoint

The [syntax-directed operation](#) `IdentifierCodePoint` takes no arguments and returns a code point. It is defined piecewise over the following productions:

`IdentifierStart` :: `IdentifierStartChar`

1. Return the code point matched by `IdentifierStartChar`.

`IdentifierPart` :: `IdentifierPartChar`

1. Return the code point matched by `IdentifierPartChar`.

`UnicodeEscapeSequence` :: `u Hex4Digits`

1. Return the code point whose numeric value is the MV of `Hex4Digits`.

`UnicodeEscapeSequence` :: `u{ CodePoint }`

1. Return the code point whose numeric value is the MV of `CodePoint`.

## 12.7.2 Keywords and Reserved Words

A *keyword* is a token that matches `IdentifierName`, but also has a syntactic use; that is, it appears literally, in a **fixed width** font, in some syntactic production. The keywords of ECMAScript include **if**, **while**, **async**, **await**, and many others.

A *reserved word* is an `IdentifierName` that cannot be used as an identifier. Many keywords are reserved words, but some are not, and some are reserved only in certain contexts. **if** and **while** are reserved words. **await** is reserved only inside `async` functions and modules. **async** is not reserved; it can be used as a variable name or statement label without restriction.

This specification uses a combination of grammatical productions and [early error](#) rules to specify which names are valid identifiers and which are reserved words. All tokens in the `ReservedWord` list below, except

for **await** and **yield**, are unconditionally reserved. Exceptions for **await** and **yield** are specified in 13.1, using parameterized syntactic productions. Lastly, several [early error](#) rules restrict the set of valid identifiers. See 13.1.1, 14.3.1.1, 14.7.5.1, and 15.7.1. In summary, there are five categories of identifier names:

- Those that are always allowed as identifiers, and are not keywords, such as **Math**, **window**, **toString**, and **\_**;
- Those that are never allowed as identifiers, namely the *ReservedWords* listed below except **await** and **yield**;
- Those that are contextually allowed as identifiers, namely **await** and **yield**;
- Those that are contextually disallowed as identifiers, in [strict mode code](#): **let**, **static**, **implements**, **interface**, **package**, **private**, **protected**, and **public**;
- Those that are always allowed as identifiers, but also appear as keywords within certain syntactic productions, at places where *Identifier* is not allowed: **as**, **async**, **from**, **get**, **meta**, **of**, **set**, and **target**.

The term *conditional keyword*, or *contextual keyword*, is sometimes used to refer to the keywords that fall in the last three categories, and thus can be used as identifiers in some contexts and as keywords in others.

## Syntax

*ReservedWord* :: one of

```
await break case catch class const continue debugger default delete do
else enum export extends false finally for function if import in
instanceof new null return super switch this throw true try typeof
var void while with yield
```

NOTE 1 Per 5.1.5, keywords in the grammar match literal sequences of specific *SourceCharacter* elements. A code point in a keyword cannot be expressed by a *UnicodeEscapeSequence*.

An *IdentifierName* can contain *UnicodeEscapeSequences*, but it is not possible to declare a variable named "else" by spelling it `els\u{65}`. The [early error](#) rules in 13.1.1 rule out identifiers with the same [StringValue](#) as a reserved word.

NOTE 2 **enum** is not currently used as a keyword in this specification. It is a *future reserved word*, set aside for use as a keyword in future language extensions.

Similarly, **implements**, **interface**, **package**, **private**, **protected**, and **public** are future reserved words in [strict mode code](#).

NOTE 3 The names **arguments** and **eval** are not keywords, but they are subject to some restrictions in [strict mode code](#). See 13.1.1, 8.6.4, 15.2.1, 15.5.1, 15.6.1, and 15.8.1.

## 12.8 Punctuators

### Syntax

*Punctuator* ::  
*OptionalChainingPunctuator*  
*OtherPunctuator*

*OptionalChainingPunctuator* ::  
 ?. [lookahead  $\notin$  *DecimalDigit*]



*OtherPunctuator* :: one of

```
{ ( ) [ ] . . . . ; , < > <= >= == != === !== + - * % ** ++ -- << >> >>> &
| ^ ! ~ && || ?? ? : = += -= *= %= **= <<= >>= >>>= &= |= ^= &&= ||=
??= =>
```

*DivPunctuator* ::

```
/
/=
```

*RightBracePunctuator* ::

```
}
```

## 12.9 Literals

### 12.9.1 Null Literals

#### Syntax

```
NullLiteral ::
    null
```

### 12.9.2 Boolean Literals

#### Syntax

```
BooleanLiteral ::
    true
    false
```

### 12.9.3 Numeric Literals

#### Syntax

*NumericLiteralSeparator* ::

```
–
```

*NumericLiteral* ::

```
DecimalLiteral
DecimalBigIntLiteral
NonDecimalIntegerLiteral[+Sep]
NonDecimalIntegerLiteral[+Sep] BigIntLiteralSuffix
LegacyOctalIntegerLiteral
```

*DecimalBigIntLiteral* ::

```
0 BigIntLiteralSuffix
NonZeroDigit DecimalDigits[+Sep] opt BigIntLiteralSuffix
NonZeroDigit NumericLiteralSeparator DecimalDigits[+Sep] BigIntLiteralSuffix
```

*NonDecimalIntegerLiteral*<sub>[Sep]</sub> ::

```
BinaryIntegerLiteral[?Sep]
OctalIntegerLiteral[?Sep]
HexIntegerLiteral[?Sep]
```

*BigIntLiteralSuffix* ::

**n**

*DecimalLiteral* ::

*DecimalIntegerLiteral* . *DecimalDigits*<sub>[+Sep] opt</sub> *ExponentPart*<sub>[+Sep] opt</sub>  
 . *DecimalDigits*<sub>[+Sep]</sub> *ExponentPart*<sub>[+Sep] opt</sub>  
*DecimalIntegerLiteral* *ExponentPart*<sub>[+Sep] opt</sub>

*DecimalIntegerLiteral* ::

**0**

*NonZeroDigit*

*NonZeroDigit* *NumericLiteralSeparator*<sub>opt</sub> *DecimalDigits*<sub>[+Sep]</sub>

*NonOctalDecimalIntegerLiteral*

*DecimalDigits*<sub>[Sep]</sub> ::

*DecimalDigit*

*DecimalDigits*<sub>[?Sep]</sub> *DecimalDigit*

<sub>[+Sep]</sub> *DecimalDigits*<sub>[+Sep]</sub> *NumericLiteralSeparator* *DecimalDigit*

*DecimalDigit* :: **one of**

**0 1 2 3 4 5 6 7 8 9**

*NonZeroDigit* :: **one of**

**1 2 3 4 5 6 7 8 9**

*ExponentPart*<sub>[Sep]</sub> ::

*ExponentIndicator* *SignedInteger*<sub>[?Sep]</sub>

*ExponentIndicator* :: **one of**

**e E**

*SignedInteger*<sub>[Sep]</sub> ::

*DecimalDigits*<sub>[?Sep]</sub>

**+** *DecimalDigits*<sub>[?Sep]</sub>

**-** *DecimalDigits*<sub>[?Sep]</sub>

*BinaryIntegerLiteral*<sub>[Sep]</sub> ::

**0b** *BinaryDigits*<sub>[?Sep]</sub>

**0B** *BinaryDigits*<sub>[?Sep]</sub>

*BinaryDigits*<sub>[Sep]</sub> ::

*BinaryDigit*

*BinaryDigits*<sub>[?Sep]</sub> *BinaryDigit*

<sub>[+Sep]</sub> *BinaryDigits*<sub>[+Sep]</sub> *NumericLiteralSeparator* *BinaryDigit*

*BinaryDigit* :: **one of**

**0 1**

*OctalIntegerLiteral*<sub>[Sep]</sub> ::

**0o** *OctalDigits*<sub>[?Sep]</sub>

**0O** *OctalDigits*<sub>[?Sep]</sub>

*OctalDigits*<sub>[Sep]</sub> ::

```

OctalDigit
OctalDigits[?Sep] OctalDigit
[+Sep] OctalDigits[+Sep] NumericLiteralSeparator OctalDigit

LegacyOctalIntegerLiteral ::
  0 OctalDigit
  LegacyOctalIntegerLiteral OctalDigit

NonOctalDecimalIntegerLiteral ::
  0 NonOctalDigit
  LegacyOctalLikeDecimalIntegerLiteral NonOctalDigit
  NonOctalDecimalIntegerLiteral DecimalDigit

LegacyOctalLikeDecimalIntegerLiteral ::
  0 OctalDigit
  LegacyOctalLikeDecimalIntegerLiteral OctalDigit

OctalDigit :: one of
  0 1 2 3 4 5 6 7

NonOctalDigit :: one of
  8 9

HexIntegerLiteral[Sep] ::
  0x HexDigits[?Sep]
  0X HexDigits[?Sep]

HexDigits[Sep] ::
  HexDigit
  HexDigits[?Sep] HexDigit
[+Sep] HexDigits[+Sep] NumericLiteralSeparator HexDigit

HexDigit :: one of
  0 1 2 3 4 5 6 7 8 9 a b c d e f A B C D E F

```

The *SourceCharacter* immediately following a *NumericLiteral* must not be an *IdentifierStart* or *DecimalDigit*.

**NOTE** For example: `3in` is an error and not the two input elements `3` and `in`.

### 12.9.3.1 Static Semantics: Early Errors

```

NumericLiteral :: LegacyOctalIntegerLiteral
DecimalIntegerLiteral :: NonOctalDecimalIntegerLiteral

```

- It is a Syntax Error if the [source text matched by this production](#) is [strict mode code](#).

**NOTE** In [non-strict code](#), this syntax is [Legacy](#).

### 12.9.3.2 Static Semantics: MV

A numeric literal stands for a value of the [Number type](#) or the [BigInt type](#).

- The MV of `DecimalLiteral :: DecimalIntegerLiteral . DecimalDigits` is the MV of `DecimalIntegerLiteral` plus (the MV of `DecimalDigits` × 10<sup>-*n*</sup>), where *n* is the number of code points in `DecimalDigits`, excluding all

- occurrences of *NumericLiteralSeparator*.
- The MV of *DecimalLiteral* :: *DecimalIntegerLiteral* . *ExponentPart* is the MV of *DecimalIntegerLiteral* × 10<sup>e</sup>, where *e* is the MV of *ExponentPart*.
  - The MV of *DecimalLiteral* :: *DecimalIntegerLiteral* . *DecimalDigits* *ExponentPart* is (the MV of *DecimalIntegerLiteral* plus (the MV of *DecimalDigits* × 10<sup>-n</sup>) × 10<sup>e</sup>, where *n* is the number of code points in *DecimalDigits*, excluding all occurrences of *NumericLiteralSeparator* and *e* is the MV of *ExponentPart*.
  - The MV of *DecimalLiteral* :: . *DecimalDigits* is the MV of *DecimalDigits* × 10<sup>-n</sup>, where *n* is the number of code points in *DecimalDigits*, excluding all occurrences of *NumericLiteralSeparator*.
  - The MV of *DecimalLiteral* :: . *DecimalDigits* *ExponentPart* is the MV of *DecimalDigits* × 10<sup>e-n</sup>, where *n* is the number of code points in *DecimalDigits*, excluding all occurrences of *NumericLiteralSeparator*, and *e* is the MV of *ExponentPart*.
  - The MV of *DecimalLiteral* :: *DecimalIntegerLiteral* *ExponentPart* is the MV of *DecimalIntegerLiteral* × 10<sup>e</sup>, where *e* is the MV of *ExponentPart*.
  - The MV of *DecimalIntegerLiteral* :: 0 is 0.
  - The MV of *DecimalIntegerLiteral* :: *NonZeroDigit* *NumericLiteralSeparator*<sub>opt</sub> *DecimalDigits* is (the MV of *NonZeroDigit* × 10<sup>n</sup>) plus the MV of *DecimalDigits*, where *n* is the number of code points in *DecimalDigits*, excluding all occurrences of *NumericLiteralSeparator*.
  - The MV of *DecimalDigits* :: *DecimalDigits* *DecimalDigit* is (the MV of *DecimalDigits* × 10) plus the MV of *DecimalDigit*.
  - The MV of *DecimalDigits* :: *DecimalDigits* *NumericLiteralSeparator* *DecimalDigit* is (the MV of *DecimalDigits* × 10) plus the MV of *DecimalDigit*.
  - The MV of *ExponentPart* :: *ExponentIndicator* *SignedInteger* is the MV of *SignedInteger*.
  - The MV of *SignedInteger* :: - *DecimalDigits* is the negative of the MV of *DecimalDigits*.
  - The MV of *DecimalDigit* :: 0 or of *HexDigit* :: 0 or of *OctalDigit* :: 0 or of *LegacyOctalEscapeSequence* :: 0 or of *BinaryDigit* :: 0 is 0.
  - The MV of *DecimalDigit* :: 1 or of *NonZeroDigit* :: 1 or of *HexDigit* :: 1 or of *OctalDigit* :: 1 or of *BinaryDigit* :: 1 is 1.
  - The MV of *DecimalDigit* :: 2 or of *NonZeroDigit* :: 2 or of *HexDigit* :: 2 or of *OctalDigit* :: 2 is 2.
  - The MV of *DecimalDigit* :: 3 or of *NonZeroDigit* :: 3 or of *HexDigit* :: 3 or of *OctalDigit* :: 3 is 3.
  - The MV of *DecimalDigit* :: 4 or of *NonZeroDigit* :: 4 or of *HexDigit* :: 4 or of *OctalDigit* :: 4 is 4.
  - The MV of *DecimalDigit* :: 5 or of *NonZeroDigit* :: 5 or of *HexDigit* :: 5 or of *OctalDigit* :: 5 is 5.
  - The MV of *DecimalDigit* :: 6 or of *NonZeroDigit* :: 6 or of *HexDigit* :: 6 or of *OctalDigit* :: 6 is 6.
  - The MV of *DecimalDigit* :: 7 or of *NonZeroDigit* :: 7 or of *HexDigit* :: 7 or of *OctalDigit* :: 7 is 7.
  - The MV of *DecimalDigit* :: 8 or of *NonZeroDigit* :: 8 or of *NonOctalDigit* :: 8 or of *HexDigit* :: 8 is 8.
  - The MV of *DecimalDigit* :: 9 or of *NonZeroDigit* :: 9 or of *NonOctalDigit* :: 9 or of *HexDigit* :: 9 is 9.
  - The MV of *HexDigit* :: a or of *HexDigit* :: A is 10.
  - The MV of *HexDigit* :: b or of *HexDigit* :: B is 11.
  - The MV of *HexDigit* :: c or of *HexDigit* :: C is 12.
  - The MV of *HexDigit* :: d or of *HexDigit* :: D is 13.
  - The MV of *HexDigit* :: e or of *HexDigit* :: E is 14.
  - The MV of *HexDigit* :: f or of *HexDigit* :: F is 15.
  - The MV of *BinaryDigits* :: *BinaryDigits* *BinaryDigit* is (the MV of *BinaryDigits* × 2) plus the MV of *BinaryDigit*.
  - The MV of *BinaryDigits* :: *BinaryDigits* *NumericLiteralSeparator* *BinaryDigit* is (the MV of *BinaryDigits* × 2) plus the MV of *BinaryDigit*.
  - The MV of *OctalDigits* :: *OctalDigits* *OctalDigit* is (the MV of *OctalDigits* × 8) plus the MV of *OctalDigit*.
  - The MV of *OctalDigits* :: *OctalDigits* *NumericLiteralSeparator* *OctalDigit* is (the MV of *OctalDigits* × 8) plus the MV of *OctalDigit*.
  - The MV of *LegacyOctalIntegerLiteral* :: *LegacyOctalIntegerLiteral* *OctalDigit* is (the MV of *LegacyOctalIntegerLiteral* times 8) plus the MV of *OctalDigit*.
  - The MV of *NonOctalDecimalIntegerLiteral* :: *LegacyOctalLikeDecimalIntegerLiteral* *NonOctalDigit* is (the MV of *LegacyOctalLikeDecimalIntegerLiteral* times 10) plus the MV of *NonOctalDigit*.
  - The MV of *NonOctalDecimalIntegerLiteral* :: *NonOctalDecimalIntegerLiteral* *DecimalDigit* is (the MV of *NonOctalDecimalIntegerLiteral* times 10) plus the MV of *DecimalDigit*.
  - The MV of *LegacyOctalLikeDecimalIntegerLiteral* :: *LegacyOctalLikeDecimalIntegerLiteral* *OctalDigit* is (the MV of *LegacyOctalLikeDecimalIntegerLiteral* times 10) plus the MV of *OctalDigit*.
  - The MV of *HexDigits* :: *HexDigits* *HexDigit* is (the MV of *HexDigits* × 16) plus the MV of *HexDigit*.
  - The MV of *HexDigits* :: *HexDigits* *NumericLiteralSeparator* *HexDigit* is (the MV of *HexDigits* × 16) plus the MV of *HexDigit*.

### 12.9.3.3 Static Semantics: NumericValue

The [syntax-directed operation](#) `NumericValue` takes no arguments and returns a `Number` or a `BigInt`. It is defined piecewise over the following productions:

*NumericLiteral* :: *DecimalLiteral*

1. Return `RoundMVResult`(MV of *DecimalLiteral*).

*NumericLiteral* :: *NonDecimalIntegerLiteral*

1. Return  $\mathbb{F}$ (MV of *NonDecimalIntegerLiteral*).

*NumericLiteral* :: *LegacyOctalIntegerLiteral*

1. Return  $\mathbb{F}$ (MV of *LegacyOctalIntegerLiteral*).

*NumericLiteral* :: *NonDecimalIntegerLiteral BigIntLiteralSuffix*

1. Return the `BigInt` value that represents the MV of *NonDecimalIntegerLiteral*.

*DecimalBigIntLiteral* :: `0` *BigIntLiteralSuffix*

1. Return `0Z`.

*DecimalBigIntLiteral* :: *NonZeroDigit BigIntLiteralSuffix*

1. Return the `BigInt` value that represents the MV of *NonZeroDigit*.

*DecimalBigIntLiteral* ::

*NonZeroDigit DecimalDigits BigIntLiteralSuffix*

*NonZeroDigit NumericLiteralSeparator DecimalDigits BigIntLiteralSuffix*

1. Let *n* be the number of code points in *DecimalDigits*, excluding all occurrences of *NumericLiteralSeparator*.
2. Let *mv* be (the MV of *NonZeroDigit* × 10<sup>*n*</sup>) plus the MV of *DecimalDigits*.
3. Return  $\mathbb{Z}$ (*mv*).

### 12.9.4 String Literals

**NOTE 1** A string literal is 0 or more Unicode code points enclosed in single or double quotes. Unicode code points may also be represented by an escape sequence. All code points may appear literally in a string literal except for the closing quote code points, U+005C (REVERSE SOLIDUS), U+000D (CARRIAGE RETURN), and U+000A (LINE FEED). Any code points may appear in the form of an escape sequence. String literals evaluate to ECMAScript String values. When generating these String values Unicode code points are UTF-16 encoded as defined in 11.1.1. Code points belonging to the Basic Multilingual Plane are encoded as a single code unit element of the string. All other code points are encoded as two code unit elements of the string.

#### Syntax

*StringLiteral* ::

" *DoubleStringCharacters*<sub>opt</sub> "

' *SingleStringCharacters*<sub>opt</sub> '

*DoubleStringCharacters* ::

*DoubleStringCharacter DoubleStringCharacters*<sub>opt</sub>

*SingleStringCharacters* ::

*SingleStringCharacter SingleStringCharacters*<sub>opt</sub>

*DoubleStringCharacter* ::

*SourceCharacter* but not one of " or \ or *LineTerminator*

<LS>

<PS>

\ *EscapeSequence*

*LineContinuation*

*SingleStringCharacter* ::

*SourceCharacter* but not one of ' or \ or *LineTerminator*

<LS>

<PS>

\ *EscapeSequence*

*LineContinuation*

*LineContinuation* ::

\ *LineTerminatorSequence*

*EscapeSequence* ::

*CharacterEscapeSequence*

**0** [lookahead  $\notin$  *DecimalDigit*]

*LegacyOctalEscapeSequence*

*NonOctalDecimalEscapeSequence*

*HexEscapeSequence*

*UnicodeEscapeSequence*

*CharacterEscapeSequence* ::

*SingleEscapeCharacter*

*NonEscapeCharacter*

*SingleEscapeCharacter* :: **one of**

' " \ **b f n r t v**

*NonEscapeCharacter* ::

*SourceCharacter* but not one of *EscapeCharacter* or *LineTerminator*

*EscapeCharacter* ::

*SingleEscapeCharacter*

*DecimalDigit*

**x**

**u**

*LegacyOctalEscapeSequence* ::

**0** [lookahead  $\in$  { **8** , **9** }]

*NonZeroOctalDigit* [lookahead  $\notin$  *OctalDigit*]

*ZeroToThree OctalDigit* [lookahead  $\notin$  *OctalDigit*]

*FourToSeven OctalDigit*

*ZeroToThree OctalDigit OctalDigit*

*NonZeroOctalDigit* ::

*OctalDigit* but not **0**

*ZeroToThree* :: **one of**

0 1 2 3

*FourToSeven* :: one of  
4 5 6 7

*NonOctalDecimalEscapeSequence* :: one of  
8 9

*HexEscapeSequence* ::  
x *HexDigit HexDigit*

*UnicodeEscapeSequence* ::  
u *Hex4Digits*  
u{ *CodePoint* }

*Hex4Digits* ::  
*HexDigit HexDigit HexDigit HexDigit*

The definition of the nonterminal *HexDigit* is given in 12.9.3. *SourceCharacter* is defined in 11.1.

NOTE 2 <LF> and <CR> cannot appear in a string literal, except as part of a *LineContinuation* to produce the empty code points sequence. The proper way to include either in the String value of a string literal is to use an escape sequence such as `\n` or `\u000A`.

### 12.9.4.1 Static Semantics: Early Errors

*EscapeSequence* ::  
*LegacyOctalEscapeSequence*  
*NonOctalDecimalEscapeSequence*

- It is a Syntax Error if the source text matched by this production is [strict mode code](#).

NOTE 1 In [non-strict code](#), this syntax is [Legacy](#).

NOTE 2 It is possible for string literals to precede a [Use Strict Directive](#) that places the enclosing code in [strict mode](#), and implementations must take care to enforce the above rules for such literals. For example, the following source text contains a Syntax Error:

```
function invalid() { "\7"; "use strict"; }
```

### 12.9.4.2 Static Semantics: SV

The [syntax-directed operation](#) SV takes no arguments and returns a String.

A string literal stands for a value of the [String type](#). SV produces String values for string literals through recursive application on the various parts of the string literal. As part of this process, some Unicode code points within the string literal are interpreted as having a [mathematical value](#), as described below or in 12.9.3.

- The SV of *StringLiteral* :: " " is the empty String.
- The SV of *StringLiteral* :: ' ' is the empty String.
- The SV of *DoubleStringCharacters* :: *DoubleStringCharacter DoubleStringCharacters* is the [string-concatenation](#) of the SV of *DoubleStringCharacter* and the SV of *DoubleStringCharacters*.
- The SV of *SingleStringCharacters* :: *SingleStringCharacter SingleStringCharacters* is the [string-concatenation](#) of the SV of *SingleStringCharacter* and the SV of *SingleStringCharacters*.

- The SV of *DoubleStringCharacter* :: *SourceCharacter* but not one of " or \ or *LineTerminator* is the result of performing [UTF16EncodeCodePoint](#) on the code point matched by *SourceCharacter*.
- The SV of *DoubleStringCharacter* :: <LS> is the String value consisting of the code unit 0x2028 (LINE SEPARATOR).
- The SV of *DoubleStringCharacter* :: <PS> is the String value consisting of the code unit 0x2029 (PARAGRAPH SEPARATOR).
- The SV of *DoubleStringCharacter* :: *LineContinuation* is the empty String.
- The SV of *SingleStringCharacter* :: *SourceCharacter* but not one of ' or \ or *LineTerminator* is the result of performing [UTF16EncodeCodePoint](#) on the code point matched by *SourceCharacter*.
- The SV of *SingleStringCharacter* :: <LS> is the String value consisting of the code unit 0x2028 (LINE SEPARATOR).
- The SV of *SingleStringCharacter* :: <PS> is the String value consisting of the code unit 0x2029 (PARAGRAPH SEPARATOR).
- The SV of *SingleStringCharacter* :: *LineContinuation* is the empty String.
- The SV of *EscapeSequence* :: 0 is the String value consisting of the code unit 0x0000 (NULL).
- The SV of *CharacterEscapeSequence* :: *SingleEscapeCharacter* is the String value consisting of the code unit whose numeric value is determined by the *SingleEscapeCharacter* according to [Table 37](#).

**Table 37: String Single Character Escape Sequences**

Escape Sequence	Code Unit Value	Unicode Character Name	Symbol
\b	0x0008	BACKSPACE	<BS>
\t	0x0009	CHARACTER TABULATION	<HT>
\n	0x000A	LINE FEED (LF)	<LF>
\v	0x000B	LINE TABULATION	<VT>
\f	0x000C	FORM FEED (FF)	<FF>
\r	0x000D	CARRIAGE RETURN (CR)	<CR>
\"	0x0022	QUOTATION MARK	"
\'	0x0027	APOSTROPHE	'
\\	0x005C	REVERSE SOLIDUS	\

- The SV of *NonEscapeCharacter* :: *SourceCharacter* but not one of *EscapeCharacter* or *LineTerminator* is the result of performing [UTF16EncodeCodePoint](#) on the code point matched by *SourceCharacter*.
- The SV of *EscapeSequence* :: *LegacyOctalEscapeSequence* is the String value consisting of the code unit whose numeric value is the MV of *LegacyOctalEscapeSequence*.
- The SV of *NonOctalDecimalEscapeSequence* :: 8 is the String value consisting of the code unit 0x0038 (DIGIT EIGHT).
- The SV of *NonOctalDecimalEscapeSequence* :: 9 is the String value consisting of the code unit 0x0039 (DIGIT NINE).
- The SV of *HexEscapeSequence* :: x *HexDigit HexDigit* is the String value consisting of the code unit whose numeric value is the MV of *HexEscapeSequence*.
- The SV of *Hex4Digits* :: *HexDigit HexDigit HexDigit HexDigit* is the String value consisting of the code unit whose numeric value is the MV of *Hex4Digits*.
- The SV of *UnicodeEscapeSequence* :: u{ *CodePoint* } is the result of performing [UTF16EncodeCodePoint](#) on the MV of *CodePoint*.
- The SV of *TemplateEscapeSequence* :: 0 is the String value consisting of the code unit 0x0000 (NULL).

### 12.9.4.3 Static Semantics: MV

- The MV of *LegacyOctalEscapeSequence* :: *ZeroToThree OctalDigit* is (8 times the MV of *ZeroToThree* ) plus the MV of *OctalDigit*.



- The MV of *LegacyOctalEscapeSequence* :: *FourToSeven OctalDigit* is (8 times the MV of *FourToSeven*) plus the MV of *OctalDigit*.
- The MV of *LegacyOctalEscapeSequence* :: *ZeroToThree OctalDigit OctalDigit* is (64 (that is,  $8^2$ ) times the MV of *ZeroToThree*) plus (8 times the MV of the first *OctalDigit*) plus the MV of the second *OctalDigit*.
- The MV of *ZeroToThree* :: **0** is 0.
- The MV of *ZeroToThree* :: **1** is 1.
- The MV of *ZeroToThree* :: **2** is 2.
- The MV of *ZeroToThree* :: **3** is 3.
- The MV of *FourToSeven* :: **4** is 4.
- The MV of *FourToSeven* :: **5** is 5.
- The MV of *FourToSeven* :: **6** is 6.
- The MV of *FourToSeven* :: **7** is 7.
- The MV of *HexEscapeSequence* :: **x** *HexDigit HexDigit* is (16 times the MV of the first *HexDigit*) plus the MV of the second *HexDigit*.
- The MV of *Hex4Digits* :: *HexDigit HexDigit HexDigit HexDigit* is ( $0x1000 \times$  the MV of the first *HexDigit*) plus ( $0x100 \times$  the MV of the second *HexDigit*) plus ( $0x10 \times$  the MV of the third *HexDigit*) plus the MV of the fourth *HexDigit*.

### 12.9.5 Regular Expression Literals

**NOTE 1** A regular expression literal is an input element that is converted to a RegExp object (see 22.2) each time the literal is evaluated. Two regular expression literals in a program evaluate to regular expression objects that never compare as `===` to each other even if the two literals' contents are identical. A RegExp object may also be created at runtime by **new** **RegExp** or calling the RegExp **constructor** as a function (see 22.2.4).

The productions below describe the syntax for a regular expression literal and are used by the input element scanner to find the end of the regular expression literal. The source text comprising the *RegularExpressionBody* and the *RegularExpressionFlags* are subsequently parsed again using the more stringent ECMAScript Regular Expression grammar (22.2.1).

An implementation may extend the ECMAScript Regular Expression grammar defined in 22.2.1, but it must not extend the *RegularExpressionBody* and *RegularExpressionFlags* productions defined below or the productions used by these productions.

#### Syntax

```

RegularExpressionLiteral ::
    / RegularExpressionBody / RegularExpressionFlags

RegularExpressionBody ::
    RegularExpressionFirstChar RegularExpressionChars

RegularExpressionChars ::
    [empty]
    RegularExpressionChars RegularExpressionChar

RegularExpressionFirstChar ::
    RegularExpressionNonTerminator but not one of * or \ or / or [
    RegularExpressionBackslashSequence
    RegularExpressionClass

RegularExpressionChar ::
    RegularExpressionNonTerminator but not one of \ or / or [
    RegularExpressionBackslashSequence
    RegularExpressionClass

RegularExpressionBackslashSequence ::
    \ RegularExpressionNonTerminator

```

```

RegularExpressionNonTerminator ::
    SourceCharacter but not LineTerminator

RegularExpressionClass ::
    [ RegularExpressionClassChars ]

RegularExpressionClassChars ::
    [empty]
    RegularExpressionClassChars RegularExpressionClassChar

RegularExpressionClassChar ::
    RegularExpressionNonTerminator but not one of ] or \
    RegularExpressionBackslashSequence

RegularExpressionFlags ::
    [empty]
    RegularExpressionFlags IdentifierPartChar

```

NOTE 2 Regular expression literals may not be empty; instead of representing an empty regular expression literal, the code unit sequence `//` starts a single-line comment. To specify an empty regular expression, use: `/(?:)/`.

### 12.9.5.1 Static Semantics: **BodyText**

The [syntax-directed operation](#) `BodyText` takes no arguments and returns source text. It is defined piecewise over the following productions:

```
RegularExpressionLiteral :: / RegularExpressionBody / RegularExpressionFlags
```

1. Return the source text that was recognized as *RegularExpressionBody*.

### 12.9.5.2 Static Semantics: **FlagText**

The [syntax-directed operation](#) `FlagText` takes no arguments and returns source text. It is defined piecewise over the following productions:

```
RegularExpressionLiteral :: / RegularExpressionBody / RegularExpressionFlags
```

1. Return the source text that was recognized as *RegularExpressionFlags*.

## 12.9.6 Template Literal Lexical Components

### Syntax

```

Template ::
    NoSubstitutionTemplate
    TemplateHead

NoSubstitutionTemplate ::
    ` TemplateCharactersopt `

TemplateHead ::
    ` TemplateCharactersopt ${

TemplateSubstitutionTail ::
    TemplateMiddle

```

*TemplateTail*

*TemplateMiddle* ::  
 } *TemplateCharacters*<sub>opt</sub> \${

*TemplateTail* ::  
 } *TemplateCharacters*<sub>opt</sub> `

*TemplateCharacters* ::  
*TemplateCharacter* *TemplateCharacters*<sub>opt</sub>

*TemplateCharacter* ::  
 \$ [lookahead ≠ {]  
 \ *TemplateEscapeSequence*  
 \ *NotEscapeSequence*  
*LineContinuation*  
*LineTerminatorSequence*  
*SourceCharacter* but not one of ` or \ or \$ or *LineTerminator*

*TemplateEscapeSequence* ::  
*CharacterEscapeSequence*  
 0 [lookahead ≠ *DecimalDigit*]  
*HexEscapeSequence*  
*UnicodeEscapeSequence*

*NotEscapeSequence* ::  
 0 *DecimalDigit*  
*DecimalDigit* but not 0  
 x [lookahead ≠ *HexDigit*]  
 x *HexDigit* [lookahead ≠ *HexDigit*]  
 u [lookahead ≠ *HexDigit*] [lookahead ≠ {]  
 u *HexDigit* [lookahead ≠ *HexDigit*]  
 u *HexDigit* *HexDigit* [lookahead ≠ *HexDigit*]  
 u *HexDigit* *HexDigit* *HexDigit* [lookahead ≠ *HexDigit*]  
 u { [lookahead ≠ *HexDigit*]  
 u { *NotCodePoint* [lookahead ≠ *HexDigit*]  
 u { *CodePoint* [lookahead ≠ *HexDigit*] [lookahead ≠ ]}

*NotCodePoint* ::  
*HexDigits*<sub>[~Sep]</sub> but only if MV of *HexDigits* > 0x10FFFF

*CodePoint* ::  
*HexDigits*<sub>[~Sep]</sub> but only if MV of *HexDigits* ≤ 0x10FFFF

NOTE *TemplateSubstitutionTail* is used by the *InputElementTemplateTail* alternative lexical goal.

### 12.9.6.1 Static Semantics: TV

The [syntax-directed operation](#) TV takes no arguments and returns a String or **undefined**. A template literal component is interpreted by TV as a value of the [String type](#). TV is used to construct the indexed components of a template object (colloquially, the template values). In TV, escape sequences are replaced by the UTF-16 code unit(s) of the Unicode code point represented by the escape sequence.

- The TV of *NoSubstitutionTemplate* :: ` ` is the empty String.
- The TV of *TemplateHead* :: ` \${ is the empty String.
- The TV of *TemplateMiddle* :: } \${ is the empty String.
- The TV of *TemplateTail* :: } ` is the empty String.

- The TV of *TemplateCharacters* :: *TemplateCharacter* *TemplateCharacters* is **undefined** if the TV of *TemplateCharacter* is **undefined** or the TV of *TemplateCharacters* is **undefined**. Otherwise, it is the [string-concatenation](#) of the TV of *TemplateCharacter* and the TV of *TemplateCharacters*.
- The TV of *TemplateCharacter* :: *SourceCharacter* but not one of ``` or `\` or `$` or *LineTerminator* is the result of performing [UTF16EncodeCodePoint](#) on the code point matched by *SourceCharacter*.
- The TV of *TemplateCharacter* :: `$` is the String value consisting of the code unit 0x0024 (DOLLAR SIGN).
- The TV of *TemplateCharacter* :: `\` *TemplateEscapeSequence* is the [SV](#) of *TemplateEscapeSequence*.
- The TV of *TemplateCharacter* :: `\` *NotEscapeSequence* is **undefined**.
- The TV of *TemplateCharacter* :: *LineTerminatorSequence* is the [TRV](#) of *LineTerminatorSequence*.
- The TV of *LineContinuation* :: `\` *LineTerminatorSequence* is the empty String.

### 12.9.6.2 Static Semantics: TRV

The [syntax-directed operation](#) TRV takes no arguments and returns a String. A template literal component is interpreted by TRV as a value of the [String type](#). TRV is used to construct the raw components of a template object (colloquially, the template raw values). TRV is similar to [TV](#) with the difference being that in TRV, escape sequences are interpreted as they appear in the literal.

- The TRV of *NoSubstitutionTemplate* :: `` `` is the empty String.
- The TRV of *TemplateHead* :: `` ${` is the empty String.
- The TRV of *TemplateMiddle* :: `} ${` is the empty String.
- The TRV of *TemplateTail* :: `} `` is the empty String.
- The TRV of *TemplateCharacters* :: *TemplateCharacter* *TemplateCharacters* is the [string-concatenation](#) of the TRV of *TemplateCharacter* and the TRV of *TemplateCharacters*.
- The TRV of *TemplateCharacter* :: *SourceCharacter* but not one of ``` or `\` or `$` or *LineTerminator* is the result of performing [UTF16EncodeCodePoint](#) on the code point matched by *SourceCharacter*.
- The TRV of *TemplateCharacter* :: `$` is the String value consisting of the code unit 0x0024 (DOLLAR SIGN).
- The TRV of *TemplateCharacter* :: `\` *TemplateEscapeSequence* is the [string-concatenation](#) of the code unit 0x005C (REVERSE SOLIDUS) and the TRV of *TemplateEscapeSequence*.
- The TRV of *TemplateCharacter* :: `\` *NotEscapeSequence* is the [string-concatenation](#) of the code unit 0x005C (REVERSE SOLIDUS) and the TRV of *NotEscapeSequence*.
- The TRV of *TemplateEscapeSequence* :: `0` is the String value consisting of the code unit 0x0030 (DIGIT ZERO).
- The TRV of *NotEscapeSequence* :: `0` *DecimalDigit* is the [string-concatenation](#) of the code unit 0x0030 (DIGIT ZERO) and the TRV of *DecimalDigit*.
- The TRV of *NotEscapeSequence* :: `x` [*lookahead*  $\notin$  *HexDigit*] is the String value consisting of the code unit 0x0078 (LATIN SMALL LETTER X).
- The TRV of *NotEscapeSequence* :: `x` *HexDigit* [*lookahead*  $\notin$  *HexDigit*] is the [string-concatenation](#) of the code unit 0x0078 (LATIN SMALL LETTER X) and the TRV of *HexDigit*.
- The TRV of *NotEscapeSequence* :: `u` [*lookahead*  $\notin$  *HexDigit*] [*lookahead*  $\neq$  `{`] is the String value consisting of the code unit 0x0075 (LATIN SMALL LETTER U).
- The TRV of *NotEscapeSequence* :: `u` *HexDigit* [*lookahead*  $\notin$  *HexDigit*] is the [string-concatenation](#) of the code unit 0x0075 (LATIN SMALL LETTER U) and the TRV of *HexDigit*.
- The TRV of *NotEscapeSequence* :: `u` *HexDigit* *HexDigit* [*lookahead*  $\notin$  *HexDigit*] is the [string-concatenation](#) of the code unit 0x0075 (LATIN SMALL LETTER U), the TRV of the first *HexDigit*, and the TRV of the second *HexDigit*.
- The TRV of *NotEscapeSequence* :: `u` *HexDigit* *HexDigit* *HexDigit* [*lookahead*  $\notin$  *HexDigit*] is the [string-concatenation](#) of the code unit 0x0075 (LATIN SMALL LETTER U), the TRV of the first *HexDigit*, the TRV of the second *HexDigit*, and the TRV of the third *HexDigit*.
- The TRV of *NotEscapeSequence* :: `u` `{` [*lookahead*  $\notin$  *HexDigit*] is the [string-concatenation](#) of the code unit 0x0075 (LATIN SMALL LETTER U) and the code unit 0x007B (LEFT CURLY BRACKET).
- The TRV of *NotEscapeSequence* :: `u` `{` *NotCodePoint* [*lookahead*  $\notin$  *HexDigit*] is the [string-concatenation](#) of the code unit 0x0075 (LATIN SMALL LETTER U), the code unit 0x007B (LEFT CURLY BRACKET), and the TRV of *NotCodePoint*.
- The TRV of *NotEscapeSequence* :: `u` `{` *CodePoint* [*lookahead*  $\notin$  *HexDigit*] [*lookahead*  $\neq$  `}`] is the [string-concatenation](#) of the code unit 0x0075 (LATIN SMALL LETTER U), the code unit 0x007B (LEFT CURLY BRACKET), and the TRV of *CodePoint*.
- The TRV of *DecimalDigit* :: **one of** `0 1 2 3 4 5 6 7 8 9` is the result of performing [UTF16EncodeCodePoint](#) on the single code point matched by this production.
- The TRV of *CharacterEscapeSequence* :: *NonEscapeCharacter* is the [SV](#) of *NonEscapeCharacter*.

- The TRV of *SingleEscapeCharacter* :: **one of** ' " \ b f n r t v is the result of performing [UTF16EncodeCodePoint](#) on the single code point matched by this production.
- The TRV of *HexEscapeSequence* :: **x** *HexDigit* *HexDigit* is the [string-concatenation](#) of the code unit 0x0078 (LATIN SMALL LETTER X), the TRV of the first *HexDigit*, and the TRV of the second *HexDigit*.
- The TRV of *UnicodeEscapeSequence* :: **u** *Hex4Digits* is the [string-concatenation](#) of the code unit 0x0075 (LATIN SMALL LETTER U) and the TRV of *Hex4Digits*.
- The TRV of *UnicodeEscapeSequence* :: **u**{ *CodePoint* } is the [string-concatenation](#) of the code unit 0x0075 (LATIN SMALL LETTER U), the code unit 0x007B (LEFT CURLY BRACKET), the TRV of *CodePoint*, and the code unit 0x007D (RIGHT CURLY BRACKET).
- The TRV of *Hex4Digits* :: *HexDigit* *HexDigit* *HexDigit* *HexDigit* is the [string-concatenation](#) of the TRV of the first *HexDigit*, the TRV of the second *HexDigit*, the TRV of the third *HexDigit*, and the TRV of the fourth *HexDigit*.
- The TRV of *HexDigits* :: *HexDigits* *HexDigit* is the [string-concatenation](#) of the TRV of *HexDigits* and the TRV of *HexDigit*.
- The TRV of *HexDigit* :: **one of** 0 1 2 3 4 5 6 7 8 9 a b c d e f A B C D E F is the result of performing [UTF16EncodeCodePoint](#) on the single code point matched by this production.
- The TRV of *LineContinuation* :: \ *LineTerminatorSequence* is the [string-concatenation](#) of the code unit 0x005C (REVERSE SOLIDUS) and the TRV of *LineTerminatorSequence*.
- The TRV of *LineTerminatorSequence* :: <LF> is the String value consisting of the code unit 0x000A (LINE FEED).
- The TRV of *LineTerminatorSequence* :: <CR> is the String value consisting of the code unit 0x000A (LINE FEED).
- The TRV of *LineTerminatorSequence* :: <LS> is the String value consisting of the code unit 0x2028 (LINE SEPARATOR).
- The TRV of *LineTerminatorSequence* :: <PS> is the String value consisting of the code unit 0x2029 (PARAGRAPH SEPARATOR).
- The TRV of *LineTerminatorSequence* :: <CR> <LF> is the String value consisting of the code unit 0x000A (LINE FEED).

NOTE [TV](#) excludes the code units of *LineContinuation* while TRV includes them. <CR><LF> and <CR> *LineTerminatorSequences* are normalized to <LF> for both [TV](#) and TRV. An explicit *TemplateEscapeSequence* is needed to include a <CR> or <CR><LF> sequence.

## 12.10 Automatic Semicolon Insertion

Most ECMAScript statements and declarations must be terminated with a semicolon. Such semicolons may always appear explicitly in the source text. For convenience, however, such semicolons may be omitted from the source text in certain situations. These situations are described by saying that semicolons are automatically inserted into the source code token stream in those situations.

### 12.10.1 Rules of Automatic Semicolon Insertion

In the following rules, “token” means the actual recognized lexical token determined using the current lexical [goal symbol](#) as described in clause 12.

There are three basic rules of semicolon insertion:

1. When, as the source text is parsed from left to right, a token (called the *offending token*) is encountered that is not allowed by any production of the grammar, then a semicolon is automatically inserted before the offending token if one or more of the following conditions is true:
  - The offending token is separated from the previous token by at least one *LineTerminator*.
  - The offending token is `}`.
  - The previous token is `)` and the inserted semicolon would then be parsed as the terminating semicolon of a do-while statement (14.7.2).
2. When, as the source text is parsed from left to right, the end of the input stream of tokens is encountered and the parser is unable to parse the input token stream as a single instance of the goal nonterminal, then a semicolon is automatically inserted at the end of the input stream.

3. When, as the source text is parsed from left to right, a token is encountered that is allowed by some production of the grammar, but the production is a *restricted production* and the token would be the first token for a terminal or nonterminal immediately following the annotation “[no *Line Terminator* here]” within the restricted production (and therefore such a token is called a restricted token), and the restricted token is separated from the previous token by at least one *Line Terminator*, then a semicolon is automatically inserted before the restricted token.

However, there is an additional overriding condition on the preceding rules: a semicolon is never inserted automatically if the semicolon would then be parsed as an empty statement or if that semicolon would become one of the two semicolons in the header of a **for** statement (see 14.7.4).

NOTE The following are the only restricted productions in the grammar:

```

UpdateExpression[Yield, Await] :
    LeftHandSideExpression[?Yield, ?Await] [no Line Terminator here] ++
    LeftHandSideExpression[?Yield, ?Await] [no Line Terminator here] --
ContinueStatement[Yield, Await] :
    continue ;
    continue [no Line Terminator here] LabelIdentifier[?Yield, ?Await] ;
BreakStatement[Yield, Await] :
    break ;
    break [no Line Terminator here] LabelIdentifier[?Yield, ?Await] ;
ReturnStatement[Yield, Await] :
    return ;
    return [no Line Terminator here] Expression[+In, ?Yield, ?Await] ;
ThrowStatement[Yield, Await] :
    throw [no Line Terminator here] Expression[+In, ?Yield, ?Await] ;
YieldExpression[In, Await] :
    yield
    yield [no Line Terminator here] AssignmentExpression[?In, +Yield, ?Await]
    yield [no Line Terminator here] * AssignmentExpression[?In, +Yield, ?Await]
ArrowFunction[In, Yield, Await] :
    ArrowParameters[?Yield, ?Await] [no Line Terminator here] =>
        ConciseBody[?In]
AsyncFunctionDeclaration[Yield, Await, Default] :
    async [no Line Terminator here] function BindingIdentifier[?Yield, ?Await] (
        FormalParameters[~Yield, +Await] ) { AsyncFunctionBody }
    [+Default] async [no Line Terminator here] function (
        FormalParameters[~Yield, +Await] ) { AsyncFunctionBody }
AsyncFunctionExpression :
    async [no Line Terminator here] function
        BindingIdentifier[~Yield, +Await] opt (
        FormalParameters[~Yield, +Await] ) { AsyncFunctionBody }
AsyncMethod[Yield, Await] :
    async [no Line Terminator here] ClassElementName[?Yield, ?Await] (
        UniqueFormalParameters[~Yield, +Await] ) { AsyncFunctionBody }
AsyncGeneratorDeclaration[Yield, Await, Default] :
    async [no Line Terminator here] function * BindingIdentifier[?Yield, ?Await]
        ( FormalParameters[+Yield, +Await] ) { AsyncGeneratorBody }

```

```

AsyncGeneratorExpression :
    async [no LineTerminator here] function *
        BindingIdentifier[+Yield, +Await] opt (
            FormalParameters[+Yield, +Await] ) { AsyncGeneratorBody }
AsyncGeneratorMethod[Yield, Await] :
    async [no LineTerminator here] * ClassElementName[?Yield, ?Await] (
        UniqueFormalParameters[+Yield, +Await] ) { AsyncGeneratorBody }
AsyncArrowFunction[In, Yield, Await] :
    async [no LineTerminator here] AsyncArrowBindingIdentifier[?Yield] [no
        LineTerminator here] => AsyncConciseBody[?In]
        CoverCallExpressionAndAsyncArrowHead[?Yield, ?Await] [no LineTerminator
            here] => AsyncConciseBody[?In]
AsyncArrowHead :
    async [no LineTerminator here] ArrowFormalParameters[~Yield, +Await]

```

The practical effect of these restricted productions is as follows:

- When a `++` or `--` token is encountered where the parser would treat it as a postfix operator, and at least one *LineTerminator* occurred between the preceding token and the `++` or `--` token, then a semicolon is automatically inserted before the `++` or `--` token.
- When a `continue`, `break`, `return`, `throw`, or `yield` token is encountered and a *LineTerminator* is encountered before the next token, a semicolon is automatically inserted after the `continue`, `break`, `return`, `throw`, or `yield` token.
- When an arrow function parameter(s) are followed by a *LineTerminator* before a `=>` token, a semicolon is automatically inserted and the punctuator causes a syntax error.
- When an `async` token is followed by a *LineTerminator* before a `function` or *IdentifierName* or `(` token, a semicolon is automatically inserted and the `async` token is not treated as part of the same expression or class element as the following tokens.
- When an `async` token is followed by a *LineTerminator* before a `*` token, a semicolon is automatically inserted and the punctuator causes a syntax error.

The resulting practical advice to ECMAScript programmers is:

- A postfix `++` or `--` operator should be on the same line as its operand.
- An *Expression* in a `return` or `throw` statement or an *AssignmentExpression* in a `yield` expression should start on the same line as the `return`, `throw`, or `yield` token.
- A *LabelIdentifier* in a `break` or `continue` statement should be on the same line as the `break` or `continue` token.
- The end of an arrow function's parameter(s) and its `=>` should be on the same line.
- The `async` token preceding an asynchronous function or method should be on the same line as the immediately following token.

## 12.10.2 Examples of Automatic Semicolon Insertion

*This section is non-normative.*

The source

```
{ 1 2 } 3
```

is not a valid sentence in the ECMAScript grammar, even with the automatic semicolon insertion rules. In contrast, the source

```
{ 1
2 } 3
```

is also not a valid ECMAScript sentence, but is transformed by automatic semicolon insertion into the following:

```
{ 1  
;2 ;} 3;
```

which is a valid ECMAScript sentence.

The source

```
for (a; b  
)
```

is not a valid ECMAScript sentence and is not altered by automatic semicolon insertion because the semicolon is needed for the header of a **for** statement. Automatic semicolon insertion never inserts one of the two semicolons in the header of a **for** statement.

The source

```
return  
a + b
```

is transformed by automatic semicolon insertion into the following:

```
return;  
a + b;
```

**NOTE 1** The expression **a + b** is not treated as a value to be returned by the **return** statement, because a *LineTerminator* separates it from the token **return**.

The source

```
a = b  
++c
```

is transformed by automatic semicolon insertion into the following:

```
a = b;  
++c;
```

**NOTE 2** The token **++** is not treated as a postfix operator applying to the variable **b**, because a *LineTerminator* occurs between **b** and **++**.

The source

```
if (a > b)  
else c = d
```

is not a valid ECMAScript sentence and is not altered by automatic semicolon insertion before the **else** token, even though no production of the grammar applies at that point, because an automatically inserted semicolon would then be parsed as an empty statement.

The source

```
a = b + c  
(d + e).print()
```

is *not* transformed by automatic semicolon insertion, because the parenthesized expression that begins the second line can be interpreted as an argument list for a function call:



```
a = b + c(d + e).print()
```

In the circumstance that an assignment statement must begin with a left parenthesis, it is a good idea for the programmer to provide an explicit semicolon at the end of the preceding statement rather than to rely on automatic semicolon insertion.

### 12.10.3 Interesting Cases of Automatic Semicolon Insertion

*This section is non-normative.*

ECMAScript programs can be written in a style with very few semicolons by relying on automatic semicolon insertion. As described above, semicolons are not inserted at every newline, and automatic semicolon insertion can depend on multiple tokens across line terminators.

As new syntactic features are added to ECMAScript, additional grammar productions could be added that cause lines relying on automatic semicolon insertion preceding them to change grammar productions when parsed.

For the purposes of this section, a case of automatic semicolon insertion is considered interesting if it is a place where a semicolon may or may not be inserted, depending on the source text which precedes it. The rest of this section describes a number of interesting cases of automatic semicolon insertion in this version of ECMAScript.

#### 12.10.3.1 Interesting Cases of Automatic Semicolon Insertion in Statement Lists

In a *StatementList*, many *StatementListItems* end in semicolons, which may be omitted using automatic semicolon insertion. As a consequence of the rules above, at the end of a line ending an expression, a semicolon is required if the following line begins with any of the following:

- **An opening parenthesis (C).** Without a semicolon, the two lines together are treated as a *CallExpression*.
- **An opening square bracket (D).** Without a semicolon, the two lines together are treated as property access, rather than an *ArrayLiteral* or *ArrayAssignmentPattern*.
- **A template literal (`).** Without a semicolon, the two lines together are interpreted as a tagged Template (13.3.11), with the previous expression as the *MemberExpression*.
- **Unary + or -.** Without a semicolon, the two lines together are interpreted as a usage of the corresponding binary operator.
- **A RegExp literal.** Without a semicolon, the two lines together may be parsed instead as the *MultiplicativeOperator*, for example if the RegExp has flags.

#### 12.10.3.2 Cases of Automatic Semicolon Insertion and “[no *LineTerminator* here]”

*This section is non-normative.*

ECMAScript contains grammar productions which include “[no *LineTerminator* here]”. These productions are sometimes a means to have optional operands in the grammar. Introducing a *LineTerminator* in these locations would change the grammar production of a source text by using the grammar production without the optional operand.

The rest of this section describes a number of productions using “[no *LineTerminator* here]” in this version of ECMAScript.

##### 12.10.3.2.1 List of Grammar Productions with Optional Operands and “[no *LineTerminator* here]”

- *UpdateExpression*.
- *ContinueStatement*.
- *BreakStatement*.
- *ReturnStatement*.

- *YieldExpression*.
- Async Function Definitions (15.8) with relation to Function Definitions (15.2)

## 13 ECMAScript Language: Expressions

### 13.1 Identifiers

#### Syntax

*IdentifierReference*<sub>[Yield, Await]</sub> :

- Identifier*
- [~Yield] **yield**
- [~Await] **await**

*BindingIdentifier*<sub>[Yield, Await]</sub> :

- Identifier*
- yield**
- await**

*LabelIdentifier*<sub>[Yield, Await]</sub> :

- Identifier*
- [~Yield] **yield**
- [~Await] **await**

*Identifier* :

- IdentifierName* but not *ReservedWord*

NOTE **yield** and **await** are permitted as *BindingIdentifier* in the grammar, and prohibited with [static semantics](#) below, to prohibit automatic semicolon insertion in cases such as

```
let
await 0;
```

#### 13.1.1 Static Semantics: Early Errors

*BindingIdentifier* : *Identifier*

- It is a Syntax Error if the [source text matched by](#) this production is contained in [strict mode code](#) and the [StringValue](#) of *Identifier* is either "arguments" or "eval".

*IdentifierReference* : **yield**  
*BindingIdentifier* : **yield**  
*LabelIdentifier* : **yield**

- It is a Syntax Error if the [source text matched by](#) this production is contained in [strict mode code](#).

*IdentifierReference* : **await**  
*BindingIdentifier* : **await**  
*LabelIdentifier* : **await**

- It is a Syntax Error if the [goal symbol](#) of the syntactic grammar is *Module*.

*BindingIdentifier*<sub>[Yield, Await]</sub> : **yield**

- It is a Syntax Error if this production has a `[Yield]` parameter.

*BindingIdentifier*<sub>[Yield, Await]</sub> : **await**

- It is a Syntax Error if this production has an `[Await]` parameter.

*IdentifierReference*<sub>[Yield, Await]</sub> : *Identifier*

*BindingIdentifier*<sub>[Yield, Await]</sub> : *Identifier*

*LabelIdentifier*<sub>[Yield, Await]</sub> : *Identifier*

- It is a Syntax Error if this production has a `[Yield]` parameter and `StringValue` of *Identifier* is **"yield"**.
- It is a Syntax Error if this production has an `[Await]` parameter and `StringValue` of *Identifier* is **"await"**.

*Identifier* : *IdentifierName* but not *ReservedWord*

- It is a Syntax Error if this phrase is contained in `strict mode code` and the `StringValue` of *IdentifierName* is one of **"implements"**, **"interface"**, **"let"**, **"package"**, **"private"**, **"protected"**, **"public"**, **"static"**, or **"yield"**.
- It is a Syntax Error if the `goal symbol` of the syntactic grammar is *Module* and the `StringValue` of *IdentifierName* is **"await"**.
- It is a Syntax Error if the `StringValue` of *IdentifierName* is the `StringValue` of any *ReservedWord* except for **yield** or **await**.

NOTE `StringValue` of *IdentifierName* normalizes any Unicode escape sequences in *IdentifierName* hence such escapes cannot be used to write an *Identifier* whose code point sequence is the same as a *ReservedWord*.

### 13.1.2 Static Semantics: StringValue

The `syntax-directed operation` `StringValue` takes no arguments and returns a `String`. It is defined piecewise over the following productions:

*IdentifierName* ::

*IdentifierStart*

*IdentifierName* *IdentifierPart*

1. Let *idTextUnescaped* be `IdentifierCodePoints` of *IdentifierName*.
2. Return `CodePointsToString(idTextUnescaped)`.

*IdentifierReference* : **yield**

*BindingIdentifier* : **yield**

*LabelIdentifier* : **yield**

1. Return **"yield"**.

*IdentifierReference* : **await**

*BindingIdentifier* : **await**

*LabelIdentifier* : **await**

1. Return **"await"**.

*Identifier* : *IdentifierName* but not *ReservedWord*

1. Return the `StringValue` of *IdentifierName*.

*PrivateIdentifier* ::

# *IdentifierName*

1. Return the [string-concatenation](#) of 0x0023 (NUMBER SIGN) and the [StringValue](#) of *IdentifierName*.

*ModuleExportName* : *StringLiteral*

1. Return the [SV](#) of *StringLiteral*.

### 13.1.3 Runtime Semantics: Evaluation

*IdentifierReference* : *Identifier*

1. Return ? [ResolveBinding](#)([StringValue](#) of *Identifier*).

*IdentifierReference* : **yield**

1. Return ? [ResolveBinding](#)("yield").

*IdentifierReference* : **await**

1. Return ? [ResolveBinding](#)("await").

NOTE 1 The result of evaluating an *IdentifierReference* is always a value of type Reference.

NOTE 2 In [non-strict code](#), the [keyword](#) **yield** may be used as an identifier. Evaluating the *IdentifierReference* resolves the binding of **yield** as if it was an *Identifier*. Early Error restriction ensures that such an evaluation only can occur for [non-strict code](#).

## 13.2 Primary Expression

### Syntax

```

PrimaryExpression[Yield, Await] :
  this
  IdentifierReference[?Yield, ?Await]
  Literal
  ArrayLiteral[?Yield, ?Await]
  ObjectLiteral[?Yield, ?Await]
  FunctionExpression
  ClassExpression[?Yield, ?Await]
  GeneratorExpression
  AsyncFunctionExpression
  AsyncGeneratorExpression
  RegularExpressionLiteral
  TemplateLiteral[?Yield, ?Await, ~Tagged]
  CoverParenthesizedExpressionAndArrowParameterList[?Yield, ?Await]

```

```

CoverParenthesizedExpressionAndArrowParameterList[Yield, Await] :
  ( Expression[+In, ?Yield, ?Await] )
  ( Expression[+In, ?Yield, ?Await] , )
  ( )
  ( ... BindingIdentifier[?Yield, ?Await] )
  ( ... BindingPattern[?Yield, ?Await] )

```

( *Expression*<sub>[+In, ?Yield, ?Await]</sub> , ... *BindingIdentifier*<sub>[?Yield, ?Await]</sub> )  
 ( *Expression*<sub>[+In, ?Yield, ?Await]</sub> , ... *BindingPattern*<sub>[?Yield, ?Await]</sub> )

## Supplemental Syntax

When processing an instance of the production

*PrimaryExpression*<sub>[Yield, Await]</sub> :

*CoverParenthesizedExpressionAndArrowParameterList*<sub>[?Yield, ?Await]</sub>

the interpretation of *CoverParenthesizedExpressionAndArrowParameterList* is refined using the following grammar:

*ParenthesizedExpression*<sub>[Yield, Await]</sub> :

( *Expression*<sub>[+In, ?Yield, ?Await]</sub> )

## 13.2.1 The `this` Keyword

### 13.2.1.1 Runtime Semantics: Evaluation

*PrimaryExpression* : **this**

1. Return ? [ResolveThisBinding](#)().

## 13.2.2 Identifier Reference

See [13.1](#) for *IdentifierReference*.

## 13.2.3 Literals

### Syntax

*Literal* :

*NullLiteral*

*BooleanLiteral*

*NumericLiteral*

*StringLiteral*

### 13.2.3.1 Runtime Semantics: Evaluation

*Literal* : *NullLiteral*

1. Return **null**.

*Literal* : *BooleanLiteral*

1. If *BooleanLiteral* is the token **false**, return **false**.
2. If *BooleanLiteral* is the token **true**, return **true**.

*Literal* : *NumericLiteral*

1. Return the [NumericValue](#) of *NumericLiteral* as defined in [12.9.3](#).

*Literal* : *StringLiteral*

1. Return the *SV* of *StringLiteral* as defined in 12.9.4.2.

## 13.2.4 Array Initializer

**NOTE** An *ArrayLiteral* is an expression describing the initialization of an Array, using a list, of zero or more expressions each of which represents an array element, enclosed in square brackets. The elements need not be literals; they are evaluated each time the array initializer is evaluated.

Array elements may be elided at the beginning, middle or end of the element list. Whenever a comma in the element list is not preceded by an *AssignmentExpression* (i.e., a comma at the beginning or after another comma), the missing array element contributes to the length of the Array and increases the index of subsequent elements. Elided array elements are not defined. If an element is elided at the end of an array, that element does not contribute to the length of the Array.

### Syntax

```

ArrayLiteral[Yield, Await] :
  [ Elisionopt ]
  [ ElementList[?Yield, ?Await] ]
  [ ElementList[?Yield, ?Await] , Elisionopt ]

ElementList[Yield, Await] :
  Elisionopt AssignmentExpression[+In, ?Yield, ?Await]
  Elisionopt SpreadElement[?Yield, ?Await]
  ElementList[?Yield, ?Await] , Elisionopt
  AssignmentExpression[+In, ?Yield, ?Await]
  ElementList[?Yield, ?Await] , Elisionopt SpreadElement[?Yield, ?Await]

Elision :
  ,
  Elision ,

SpreadElement[Yield, Await] :
  ... AssignmentExpression[+In, ?Yield, ?Await]

```

### 13.2.4.1 Runtime Semantics: ArrayAccumulation

The *syntax-directed operation* *ArrayAccumulation* takes arguments *array* (an Array) and *nextIndex* (an integer) and returns either a *normal completion* containing an integer or an *abrupt completion*. It is defined piecewise over the following productions:

*Elision* : ,

1. Let *len* be *nextIndex* + 1.
2. Perform ? *Set*(*array*, "length", *F*(*len*), true).
3. NOTE: The above step throws if *len* exceeds  $2^{32}-1$ .
4. Return *len*.

*Elision* : *Elision* ,

1. Return ? *ArrayAccumulation* of *Elision* with arguments *array* and (*nextIndex* + 1).

*ElementList* : *Elision*<sub>opt</sub> *AssignmentExpression*

1. If *Elision* is present, then
  - a. Set *nextIndex* to ? *ArrayAccumulation* of *Elision* with arguments *array* and *nextIndex*.
2. Let *initResult* be ? *Evaluation* of *AssignmentExpression*.
3. Let *initValue* be ? *GetValue*(*initResult*).
4. Perform ! *CreateDataPropertyOrThrow*(*array*, ! *ToString*(*F*(*nextIndex*)), *initValue*).
5. Return *nextIndex* + 1.

*ElementList* : *Elision*<sub>opt</sub> *SpreadElement*

1. If *Elision* is present, then
  - a. Set *nextIndex* to ? *ArrayAccumulation* of *Elision* with arguments *array* and *nextIndex*.
2. Return ? *ArrayAccumulation* of *SpreadElement* with arguments *array* and *nextIndex*.

*ElementList* : *ElementList* , *Elision*<sub>opt</sub> *AssignmentExpression*

1. Set *nextIndex* to ? *ArrayAccumulation* of *ElementList* with arguments *array* and *nextIndex*.
2. If *Elision* is present, then
  - a. Set *nextIndex* to ? *ArrayAccumulation* of *Elision* with arguments *array* and *nextIndex*.
3. Let *initResult* be ? *Evaluation* of *AssignmentExpression*.
4. Let *initValue* be ? *GetValue*(*initResult*).
5. Perform ! *CreateDataPropertyOrThrow*(*array*, ! *ToString*(*F*(*nextIndex*)), *initValue*).
6. Return *nextIndex* + 1.

*ElementList* : *ElementList* , *Elision*<sub>opt</sub> *SpreadElement*

1. Set *nextIndex* to ? *ArrayAccumulation* of *ElementList* with arguments *array* and *nextIndex*.
2. If *Elision* is present, then
  - a. Set *nextIndex* to ? *ArrayAccumulation* of *Elision* with arguments *array* and *nextIndex*.
3. Return ? *ArrayAccumulation* of *SpreadElement* with arguments *array* and *nextIndex*.

*SpreadElement* : . . . *AssignmentExpression*

1. Let *spreadRef* be ? *Evaluation* of *AssignmentExpression*.
2. Let *spreadObj* be ? *GetValue*(*spreadRef*).
3. Let *iteratorRecord* be ? *GetIterator*(*spreadObj*, sync).
4. Repeat,
  - a. Let *next* be ? *IteratorStep*(*iteratorRecord*).
  - b. If *next* is **false**, return *nextIndex*.
  - c. Let *nextValue* be ? *IteratorValue*(*next*).
  - d. Perform ! *CreateDataPropertyOrThrow*(*array*, ! *ToString*(*F*(*nextIndex*)), *nextValue*).
  - e. Set *nextIndex* to *nextIndex* + 1.

**NOTE** *CreateDataPropertyOrThrow* is used to ensure that own properties are defined for the array even if the standard built-in *Array prototype object* has been modified in a manner that would preclude the creation of new own properties using `[[Set]]`.

### 13.2.4.2 Runtime Semantics: Evaluation

*ArrayLiteral* : [ *Elision*<sub>opt</sub> ]

1. Let *array* be ! *ArrayCreate*(0).
2. If *Elision* is present, then

- a. Perform ? [ArrayAccumulation](#) of *Elision* with arguments *array* and 0.
3. Return *array*.

*ArrayLiteral* : [ *ElementList* ]

1. Let *array* be ! [ArrayCreate](#)(0).
2. Perform ? [ArrayAccumulation](#) of *ElementList* with arguments *array* and 0.
3. Return *array*.

*ArrayLiteral* : [ *ElementList* , *Elision*<sub>opt</sub> ]

1. Let *array* be ! [ArrayCreate](#)(0).
2. Let *nextIndex* be ? [ArrayAccumulation](#) of *ElementList* with arguments *array* and 0.
3. If *Elision* is present, then
  - a. Perform ? [ArrayAccumulation](#) of *Elision* with arguments *array* and *nextIndex*.
4. Return *array*.

### 13.2.5 Object Initializer

**NOTE 1** An object initializer is an expression describing the initialization of an Object, written in a form resembling a literal. It is a list of zero or more pairs of [property keys](#) and associated values, enclosed in curly brackets. The values need not be literals; they are evaluated each time the object initializer is evaluated.

#### Syntax

```

ObjectLiteral[Yield, Await] :
  { }
  { PropertyDefinitionList[?Yield, ?Await] }
  { PropertyDefinitionList[?Yield, ?Await] , }

PropertyDefinitionList[Yield, Await] :
  PropertyDefinition[?Yield, ?Await]
  PropertyDefinitionList[?Yield, ?Await] , PropertyDefinition[?Yield, ?Await]

PropertyDefinition[Yield, Await] :
  IdentifierReference[?Yield, ?Await]
  CoverInitializedName[?Yield, ?Await]
  PropertyName[?Yield, ?Await] : AssignmentExpression[+In, ?Yield, ?Await]
  MethodDefinition[?Yield, ?Await]
  ... AssignmentExpression[+In, ?Yield, ?Await]

PropertyName[Yield, Await] :
  LiteralPropertyName
  ComputedPropertyName[?Yield, ?Await]

LiteralPropertyName :
  IdentifierName
  StringLiteral
  NumericLiteral

ComputedPropertyName[Yield, Await] :
  [ AssignmentExpression[+In, ?Yield, ?Await] ]
  
```



*CoverInitializedName*<sub>[Yield, Await]</sub> :

*IdentifierReference*<sub>[?Yield, ?Await]</sub> *Initializer*<sub>[+In, ?Yield, ?Await]</sub>

*Initializer*<sub>[In, Yield, Await]</sub> :

= *AssignmentExpression*<sub>[?In, ?Yield, ?Await]</sub>

NOTE 2 *MethodDefinition* is defined in 15.4.

NOTE 3 In certain contexts, *ObjectLiteral* is used as a cover grammar for a more restricted secondary grammar. The *CoverInitializedName* production is necessary to fully cover these secondary grammars. However, use of this production results in an early Syntax Error in normal contexts where an actual *ObjectLiteral* is expected.

### 13.2.5.1 Static Semantics: Early Errors

*PropertyDefinition* : *MethodDefinition*

- It is a Syntax Error if *HasDirectSuper* of *MethodDefinition* is **true**.
- It is a Syntax Error if *PrivateBoundIdentifiers* of *MethodDefinition* is not empty.

In addition to describing an actual object initializer the *ObjectLiteral* productions are also used as a cover grammar for *ObjectAssignmentPattern* and may be recognized as part of a *CoverParenthesizedExpressionAndArrowParameterList*. When *ObjectLiteral* appears in a context where *ObjectAssignmentPattern* is required the following Early Error rules are **not** applied. In addition, they are not applied when initially parsing a *CoverParenthesizedExpressionAndArrowParameterList* or *CoverCallExpressionAndAsyncArrowHead*.

*PropertyDefinition* : *CoverInitializedName*

- It is a Syntax Error if any source text is matched by this production.

NOTE 1 This production exists so that *ObjectLiteral* can serve as a cover grammar for *ObjectAssignmentPattern*. It cannot occur in an actual object initializer.

*ObjectLiteral* :

{ *PropertyDefinitionList* }

{ *PropertyDefinitionList* , }

- It is a Syntax Error if *PropertyNameList* of *PropertyDefinitionList* contains any duplicate entries for "**\_\_proto\_\_**" and at least two of those entries were obtained from productions of the form *PropertyDefinition* : *PropertyName* : *AssignmentExpression* . This rule is not applied if this *ObjectLiteral* is contained within a *Script* that is being parsed for *JSON.parse* (see step 4 of *JSON.parse*).

NOTE 2 The *List* returned by *PropertyNameList* does not include property names defined using a *ComputedPropertyName*.

### 13.2.5.2 Static Semantics: IsComputedPropertyKey

The *syntax-directed operation* *IsComputedPropertyKey* takes no arguments and returns a Boolean. It is defined piecewise over the following productions:

*PropertyName* : *LiteralPropertyName*

1. Return **false**.

*PropertyName* : *ComputedPropertyName*

1. Return **true**.

### 13.2.5.3 Static Semantics: *PropertyNameList*

The *syntax-directed operation* *PropertyNameList* takes no arguments and returns a *List* of Strings. It is defined piecewise over the following productions:

*PropertyDefinitionList* : *PropertyDefinition*

1. Let *propName* be *PropName* of *PropertyDefinition*.
2. If *propName* is empty, return a new empty *List*.
3. Return « *propName* ».

*PropertyDefinitionList* : *PropertyDefinitionList* , *PropertyDefinition*

1. Let *list* be *PropertyNameList* of *PropertyDefinitionList*.
2. Let *propName* be *PropName* of *PropertyDefinition*.
3. If *propName* is empty, return *list*.
4. Return the *list-concatenation* of *list* and « *propName* ».

### 13.2.5.4 Runtime Semantics: Evaluation

*ObjectLiteral* : { }

1. Return *OrdinaryObjectCreate*(%*Object.prototype*%).

*ObjectLiteral* :

{ *PropertyDefinitionList* }  
 { *PropertyDefinitionList* , }

1. Let *obj* be *OrdinaryObjectCreate*(%*Object.prototype*%).
2. Perform ? *PropertyDefinitionEvaluation* of *PropertyDefinitionList* with argument *obj*.
3. Return *obj*.

*LiteralPropertyName* : *IdentifierName*

1. Return *StringValue* of *IdentifierName*.

*LiteralPropertyName* : *StringLiteral*

1. Return the *SV* of *StringLiteral*.

*LiteralPropertyName* : *NumericLiteral*

1. Let *nbr* be the *NumericValue* of *NumericLiteral*.
2. Return ! *Tostring*(*nbr*).

*ComputedPropertyName* : [ *AssignmentExpression* ]

1. Let *exprValue* be ? *Evaluation* of *AssignmentExpression*.
2. Let *propName* be ? *GetValue*(*exprValue*).
3. Return ? *ToPropertyKey*(*propName*).

### 13.2.5.5 Runtime Semantics: PropertyDefinitionEvaluation

The [syntax-directed operation](#) `PropertyDefinitionEvaluation` takes argument *object* (an Object) and returns either a [normal completion containing](#) unused or an [abrupt completion](#). It is defined piecewise over the following productions:

*PropertyDefinitionList* : *PropertyDefinitionList* , *PropertyDefinition*

1. Perform ? [PropertyDefinitionEvaluation](#) of *PropertyDefinitionList* with argument *object*.
2. Perform ? [PropertyDefinitionEvaluation](#) of *PropertyDefinition* with argument *object*.
3. Return unused.

*PropertyDefinition* : . . . *AssignmentExpression*

1. Let *exprValue* be ? [Evaluation](#) of *AssignmentExpression*.
2. Let *fromValue* be ? [GetValue](#)(*exprValue*).
3. Let *excludedNames* be a new empty [List](#).
4. Perform ? [CopyDataProperties](#)(*object*, *fromValue*, *excludedNames*).
5. Return unused.

*PropertyDefinition* : *IdentifierReference*

1. Let *propName* be [StringValue](#) of *IdentifierReference*.
2. Let *exprValue* be ? [Evaluation](#) of *IdentifierReference*.
3. Let *propValue* be ? [GetValue](#)(*exprValue*).
4. **Assert:** *object* is an ordinary, extensible object with no non-configurable properties.
5. Perform ! [CreateDataPropertyOrThrow](#)(*object*, *propName*, *propValue*).
6. Return unused.

*PropertyDefinition* : *PropertyName* : *AssignmentExpression*

1. Let *propKey* be ? [Evaluation](#) of *PropertyName*.
2. If this *PropertyDefinition* is contained within a *Script* that is being evaluated for `JSON.parse` (see step 7 of `JSON.parse`), then
  - a. Let *isProtoSetter* be **false**.
3. Else if *propKey* is `"__proto__"` and `IsComputedPropertyKey` of *PropertyName* is **false**, then
  - a. Let *isProtoSetter* be **true**.
4. Else,
  - a. Let *isProtoSetter* be **false**.
5. If `IsAnonymousFunctionDefinition`(*AssignmentExpression*) is **true** and *isProtoSetter* is **false**, then
  - a. Let *propValue* be ? [NamedEvaluation](#) of *AssignmentExpression* with argument *propKey*.
6. Else,
  - a. Let *exprValueRef* be ? [Evaluation](#) of *AssignmentExpression*.
  - b. Let *propValue* be ? [GetValue](#)(*exprValueRef*).
7. If *isProtoSetter* is **true**, then
  - a. If *propValue* is an Object or *propValue* is **null**, then
    - i. Perform ! *object*.[[SetPrototypeOf]](*propValue*).
  - b. Return unused.
8. **Assert:** *object* is an ordinary, extensible object with no non-configurable properties.
9. Perform ! [CreateDataPropertyOrThrow](#)(*object*, *propKey*, *propValue*).
10. Return unused.

*PropertyDefinition* : *MethodDefinition*

1. Perform ? [MethodDefinitionEvaluation](#) of *MethodDefinition* with arguments *object* and **true**.
2. Return unused.

### 13.2.6 Function Defining Expressions

See [15.2](#) for *PrimaryExpression* : *FunctionExpression* .

See [15.5](#) for *PrimaryExpression* : *GeneratorExpression* .

See [15.7](#) for *PrimaryExpression* : *ClassExpression* .

See [15.8](#) for *PrimaryExpression* : *AsyncFunctionExpression* .

See [15.6](#) for *PrimaryExpression* : *AsyncGeneratorExpression* .

### 13.2.7 Regular Expression Literals

#### Syntax

See [12.9.5](#).

#### 13.2.7.1 Static Semantics: Early Errors

*PrimaryExpression* : *RegularExpressionLiteral*

- It is a Syntax Error if [IsValidRegularExpressionLiteral](#)(*RegularExpressionLiteral*) is **false**.

#### 13.2.7.2 Static Semantics: IsValidRegularExpressionLiteral ( *literal* )

The abstract operation [IsValidRegularExpressionLiteral](#) takes argument *literal* (a *RegularExpressionLiteral Parse Node*) and returns a Boolean. It determines if its argument is a valid regular expression literal. It performs the following steps when called:

1. Let *flags* be [FlagText](#) of *literal*.
2. If *flags* contains any code points other than **d**, **g**, **i**, **m**, **s**, **u**, or **y**, or if *flags* contains any code point more than once, return **false**.
3. If *flags* contains **u**, let *u* be **true**; else let *u* be **false**.
4. Let *patternText* be [BodyText](#) of *literal*.
5. If *u* is **false**, then
  - a. Let *stringValue* be [CodePointsToString](#)(*patternText*).
  - b. Set *patternText* to the sequence of code points resulting from interpreting each of the 16-bit elements of *stringValue* as a Unicode BMP code point. UTF-16 decoding is not applied to the elements.
6. Let *parseResult* be [ParsePattern](#)(*patternText*, *u*).
7. If *parseResult* is a [Parse Node](#), return **true**; else return **false**.

#### 13.2.7.3 Runtime Semantics: Evaluation

*PrimaryExpression* : *RegularExpressionLiteral*

1. Let *pattern* be `CodePointsToString(BodyText of RegularExpressionLiteral)`.
2. Let *flags* be `CodePointsToString(FlagText of RegularExpressionLiteral)`.
3. Return ! `RegExpCreate(pattern, flags)`.

## 13.2.8 Template Literals

### Syntax

```

TemplateLiteral[Yield, Await, Tagged] :
    NoSubstitutionTemplate
    SubstitutionTemplate[?Yield, ?Await, ?Tagged]

SubstitutionTemplate[Yield, Await, Tagged] :
    TemplateHead Expression[+In, ?Yield, ?Await]
    TemplateSpans[?Yield, ?Await, ?Tagged]

TemplateSpans[Yield, Await, Tagged] :
    TemplateTail
    TemplateMiddleList[?Yield, ?Await, ?Tagged] TemplateTail

TemplateMiddleList[Yield, Await, Tagged] :
    TemplateMiddle Expression[+In, ?Yield, ?Await]
    TemplateMiddleList[?Yield, ?Await, ?Tagged] TemplateMiddle
    Expression[+In, ?Yield, ?Await]

```

### 13.2.8.1 Static Semantics: Early Errors

*TemplateLiteral*<sub>[Yield, Await, Tagged]</sub> : *NoSubstitutionTemplate*

- It is a Syntax Error if the <sub>[Tagged]</sub> parameter was not set and *NoSubstitutionTemplate* [Contains NotEscapeSequence](#).

*TemplateLiteral*<sub>[Yield, Await, Tagged]</sub> : *SubstitutionTemplate*<sub>[?Yield, ?Await, ?Tagged]</sub>

- It is a Syntax Error if the number of elements in the result of [TemplateStrings](#) of *TemplateLiteral* with argument **false** is greater than or equal to 2<sup>32</sup>.

*SubstitutionTemplate*<sub>[Yield, Await, Tagged]</sub> : *TemplateHead Expression*<sub>[+In, ?Yield, ?Await]</sub>  
*TemplateSpans*<sub>[?Yield, ?Await, ?Tagged]</sub>

- It is a Syntax Error if the <sub>[Tagged]</sub> parameter was not set and *TemplateHead* [Contains NotEscapeSequence](#).

*TemplateSpans*<sub>[Yield, Await, Tagged]</sub> : *TemplateTail*

- It is a Syntax Error if the <sub>[Tagged]</sub> parameter was not set and *TemplateTail* [Contains NotEscapeSequence](#).

*TemplateMiddleList*<sub>[Yield, Await, Tagged]</sub> :  
*TemplateMiddle Expression*<sub>[+In, ?Yield, ?Await]</sub>  
*TemplateMiddleList*<sub>[?Yield, ?Await, ?Tagged]</sub> *TemplateMiddle*  
*Expression*<sub>[+In, ?Yield, ?Await]</sub>

- It is a Syntax Error if the `[Tagged]` parameter was not set and *TemplateMiddle* [Contains NotEscapeSequence](#).

### 13.2.8.2 Static Semantics: TemplateStrings

The [syntax-directed operation](#) `TemplateStrings` takes argument *raw* (a Boolean) and returns a [List](#) of Strings. It is defined piecewise over the following productions:

*TemplateLiteral* : *NoSubstitutionTemplate*

1. Return « [TemplateString](#)(*NoSubstitutionTemplate*, *raw*) ».

*SubstitutionTemplate* : *TemplateHead Expression TemplateSpans*

1. Let *head* be « [TemplateString](#)(*TemplateHead*, *raw*) ».
2. Let *tail* be [TemplateStrings](#) of *TemplateSpans* with argument *raw*.
3. Return the [list-concatenation](#) of *head* and *tail*.

*TemplateSpans* : *TemplateTail*

1. Return « [TemplateString](#)(*TemplateTail*, *raw*) ».

*TemplateSpans* : *TemplateMiddleList TemplateTail*

1. Let *middle* be [TemplateStrings](#) of *TemplateMiddleList* with argument *raw*.
2. Let *tail* be « [TemplateString](#)(*TemplateTail*, *raw*) ».
3. Return the [list-concatenation](#) of *middle* and *tail*.

*TemplateMiddleList* : *TemplateMiddle Expression*

1. Return « [TemplateString](#)(*TemplateMiddle*, *raw*) ».

*TemplateMiddleList* : *TemplateMiddleList TemplateMiddle Expression*

1. Let *front* be [TemplateStrings](#) of *TemplateMiddleList* with argument *raw*.
2. Let *last* be « [TemplateString](#)(*TemplateMiddle*, *raw*) ».
3. Return the [list-concatenation](#) of *front* and *last*.

### 13.2.8.3 Static Semantics: TemplateString ( *templateToken*, *raw* )

The abstract operation `TemplateString` takes arguments *templateToken* (a [NoSubstitutionTemplate Parse Node](#), a [TemplateHead Parse Node](#), a [TemplateMiddle Parse Node](#), or a [TemplateTail Parse Node](#)) and *raw* (a Boolean) and returns a String. It performs the following steps when called:

1. If *raw* is **true**, then
  - a. Let *string* be the [TRV](#) of *templateToken*.
2. Else,
  - a. Let *string* be the [TV](#) of *templateToken*.
3. Return *string*.

### 13.2.8.4 GetTemplateObject ( *templateLiteral* )

The abstract operation `GetTemplateObject` takes argument *templateLiteral* (a [Parse Node](#)) and returns an Array. It performs the following steps when called:

1. Let *realm* be the [current Realm Record](#).

2. Let *templateRegistry* be *realm*.[[TemplateMap]].
3. For each element *e* of *templateRegistry*, do
  - a. If *e*.[[Site]] is the same Parse Node as *templateLiteral*, then
    - i. Return *e*.[[Array]].
4. Let *rawStrings* be *TemplateStrings* of *templateLiteral* with argument **true**.
5. Let *cookedStrings* be *TemplateStrings* of *templateLiteral* with argument **false**.
6. Let *count* be the number of elements in the List *cookedStrings*.
7. **Assert**: *count* ≤ 2<sup>32</sup> - 1.
8. Let *template* be !*ArrayCreate*(*count*).
9. Let *rawObj* be !*ArrayCreate*(*count*).
10. Let *index* be 0.
11. Repeat, while *index* < *count*,
  - a. Let *prop* be !*Tostring*(!(*index*)).
  - b. Let *cookedValue* be *cookedStrings*[*index*].
  - c. Perform !*DefinePropertyOrThrow*(*template*, *prop*, PropertyDescriptor { [[Value]]: *cookedValue*, [[Writable]]: **false**, [[Enumerable]]: **true**, [[Configurable]]: **false** }).
  - d. Let *rawValue* be the String value *rawStrings*[*index*].
  - e. Perform !*DefinePropertyOrThrow*(*rawObj*, *prop*, PropertyDescriptor { [[Value]]: *rawValue*, [[Writable]]: **false**, [[Enumerable]]: **true**, [[Configurable]]: **false** }).
  - f. Set *index* to *index* + 1.
12. Perform !*SetIntegrityLevel*(*rawObj*, frozen).
13. Perform !*DefinePropertyOrThrow*(*template*, "raw", PropertyDescriptor { [[Value]]: *rawObj*, [[Writable]]: **false**, [[Enumerable]]: **false**, [[Configurable]]: **false** }).
14. Perform !*SetIntegrityLevel*(*template*, frozen).
15. Append the Record { [[Site]]: *templateLiteral*, [[Array]]: *template* } to *realm*.[[TemplateMap]].
16. Return *template*.

NOTE 1 The creation of a template object cannot result in an abrupt completion.

NOTE 2 Each *TemplateLiteral* in the program code of a *realm* is associated with a unique template object that is used in the evaluation of tagged Templates (13.2.8.6). The template objects are frozen and the same template object is used each time a specific tagged Template is evaluated. Whether template objects are created lazily upon first evaluation of the *TemplateLiteral* or eagerly prior to first evaluation is an implementation choice that is not observable to ECMAScript code.

NOTE 3 Future editions of this specification may define additional non-enumerable properties of template objects.

### 13.2.8.5 Runtime Semantics: SubstitutionEvaluation

The *syntax-directed operation* SubstitutionEvaluation takes no arguments and returns either a *normal completion containing a List* of ECMAScript language values or an *abrupt completion*. It is defined piecewise over the following productions:

*TemplateSpans* : *TemplateTail*

1. Return a new empty List.

*TemplateSpans* : *TemplateMiddleList* *TemplateTail*

1. Return ? [SubstitutionEvaluation](#) of *TemplateMiddleList*.

*TemplateMiddleList* : *TemplateMiddle Expression*

1. Let *subRef* be ? [Evaluation](#) of *Expression*.
2. Let *sub* be ? [GetValue](#)(*subRef*).
3. Return « *sub* ».

*TemplateMiddleList* : *TemplateMiddleList TemplateMiddle Expression*

1. Let *preceding* be ? [SubstitutionEvaluation](#) of *TemplateMiddleList*.
2. Let *nextRef* be ? [Evaluation](#) of *Expression*.
3. Let *next* be ? [GetValue](#)(*nextRef*).
4. Return the [list-concatenation](#) of *preceding* and « *next* ».

### 13.2.8.6 Runtime Semantics: Evaluation

*TemplateLiteral* : *NoSubstitutionTemplate*

1. Return the [TV](#) of *NoSubstitutionTemplate* as defined in [12.9.6](#).

*SubstitutionTemplate* : *TemplateHead Expression TemplateSpans*

1. Let *head* be the [TV](#) of *TemplateHead* as defined in [12.9.6](#).
2. Let *subRef* be ? [Evaluation](#) of *Expression*.
3. Let *sub* be ? [GetValue](#)(*subRef*).
4. Let *middle* be ? [ToString](#)(*sub*).
5. Let *tail* be ? [Evaluation](#) of *TemplateSpans*.
6. Return the [string-concatenation](#) of *head*, *middle*, and *tail*.

NOTE 1 The string conversion semantics applied to the *Expression* value are like **String.prototype.concat** rather than the + operator.

*TemplateSpans* : *TemplateTail*

1. Return the [TV](#) of *TemplateTail* as defined in [12.9.6](#).

*TemplateSpans* : *TemplateMiddleList TemplateTail*

1. Let *head* be ? [Evaluation](#) of *TemplateMiddleList*.
2. Let *tail* be the [TV](#) of *TemplateTail* as defined in [12.9.6](#).
3. Return the [string-concatenation](#) of *head* and *tail*.

*TemplateMiddleList* : *TemplateMiddle Expression*

1. Let *head* be the [TV](#) of *TemplateMiddle* as defined in [12.9.6](#).
2. Let *subRef* be ? [Evaluation](#) of *Expression*.
3. Let *sub* be ? [GetValue](#)(*subRef*).
4. Let *middle* be ? [ToString](#)(*sub*).
5. Return the [string-concatenation](#) of *head* and *middle*.

NOTE 2 The string conversion semantics applied to the *Expression* value are like **String.prototype.concat** rather than the + operator.



*TemplateMiddleList* : *TemplateMiddleList* *TemplateMiddle* *Expression*

1. Let *rest* be ? *Evaluation* of *TemplateMiddleList*.
2. Let *middle* be the *TV* of *TemplateMiddle* as defined in 12.9.6.
3. Let *subRef* be ? *Evaluation* of *Expression*.
4. Let *sub* be ? *GetValue*(*subRef*).
5. Let *last* be ? *ToString*(*sub*).
6. Return the *string-concatenation* of *rest*, *middle*, and *last*.

NOTE 3 The string conversion semantics applied to the *Expression* value are like **String.prototype.concat** rather than the + operator.

## 13.2.9 The Grouping Operator

### 13.2.9.1 Static Semantics: Early Errors

*PrimaryExpression* : *CoverParenthesizedExpressionAndArrowParameterList*

- *CoverParenthesizedExpressionAndArrowParameterList* must cover a *ParenthesizedExpression*.

### 13.2.9.2 Runtime Semantics: Evaluation

*PrimaryExpression* : *CoverParenthesizedExpressionAndArrowParameterList*

1. Let *expr* be the *ParenthesizedExpression* that is covered by *CoverParenthesizedExpressionAndArrowParameterList*.
2. Return ? *Evaluation* of *expr*.

*ParenthesizedExpression* : ( *Expression* )

1. Return ? *Evaluation* of *Expression*. This may be of type Reference.

NOTE This algorithm does not apply *GetValue* to *Evaluation* of *Expression*. The principal motivation for this is so that operators such as **delete** and **typeof** may be applied to parenthesized expressions.

## 13.3 Left-Hand-Side Expressions

### Syntax

```

MemberExpression[Yield, Await] :
  PrimaryExpression[?Yield, ?Await]
  MemberExpression[?Yield, ?Await] [ Expression[+In, ?Yield, ?Await] ]
  MemberExpression[?Yield, ?Await] . IdentifierName
  MemberExpression[?Yield, ?Await] TemplateLiteral[?Yield, ?Await, +Tagged]
  SuperProperty[?Yield, ?Await]
  MetaProperty
  new MemberExpression[?Yield, ?Await] Arguments[?Yield, ?Await]
  MemberExpression[?Yield, ?Await] . PrivateIdentifier
  
```

```

SuperProperty[Yield, Await] :
    super [ Expression[+In, ?Yield, ?Await] ]
    super . IdentifierName

MetaProperty :
    NewTarget
    ImportMeta

NewTarget :
    new . target

ImportMeta :
    import . meta

NewExpression[Yield, Await] :
    MemberExpression[?Yield, ?Await]
    new NewExpression[?Yield, ?Await]

CallExpression[Yield, Await] :
    CoverCallExpressionAndAsyncArrowHead[?Yield, ?Await]
    SuperCall[?Yield, ?Await]
    ImportCall[?Yield, ?Await]
    CallExpression[?Yield, ?Await] Arguments[?Yield, ?Await]
    CallExpression[?Yield, ?Await] [ Expression[+In, ?Yield, ?Await] ]
    CallExpression[?Yield, ?Await] . IdentifierName
    CallExpression[?Yield, ?Await] TemplateLiteral[?Yield, ?Await, +Tagged]
    CallExpression[?Yield, ?Await] . PrivateIdentifier

SuperCall[Yield, Await] :
    super Arguments[?Yield, ?Await]

ImportCall[Yield, Await] :
    import ( AssignmentExpression[+In, ?Yield, ?Await] )

Arguments[Yield, Await] :
    ( )
    ( ArgumentList[?Yield, ?Await] )
    ( ArgumentList[?Yield, ?Await] , )

ArgumentList[Yield, Await] :
    AssignmentExpression[+In, ?Yield, ?Await]
    ... AssignmentExpression[+In, ?Yield, ?Await]
    ArgumentList[?Yield, ?Await] , AssignmentExpression[+In, ?Yield, ?Await]
    ArgumentList[?Yield, ?Await] , ... AssignmentExpression[+In, ?Yield, ?Await]

OptionalExpression[Yield, Await] :
    MemberExpression[?Yield, ?Await] OptionalChain[?Yield, ?Await]
    CallExpression[?Yield, ?Await] OptionalChain[?Yield, ?Await]
    OptionalExpression[?Yield, ?Await] OptionalChain[?Yield, ?Await]

```

```

OptionalChain[Yield, Await] :
  ?. Arguments[?Yield, ?Await]
  ?. [ Expression[+In, ?Yield, ?Await] ]
  ?. IdentifierName
  ?. TemplateLiteral[?Yield, ?Await, +Tagged]
  ?. PrivateIdentifier
OptionalChain[?Yield, ?Await] Arguments[?Yield, ?Await]
OptionalChain[?Yield, ?Await] [ Expression[+In, ?Yield, ?Await] ]
OptionalChain[?Yield, ?Await] . IdentifierName
OptionalChain[?Yield, ?Await] TemplateLiteral[?Yield, ?Await, +Tagged]
OptionalChain[?Yield, ?Await] . PrivateIdentifier

LeftHandSideExpression[Yield, Await] :
  NewExpression[?Yield, ?Await]
  CallExpression[?Yield, ?Await]
  OptionalExpression[?Yield, ?Await]

```

## Supplemental Syntax

When processing an instance of the production

*CallExpression* : *CoverCallExpressionAndAsyncArrowHead*  
 the interpretation of *CoverCallExpressionAndAsyncArrowHead* is refined using the following grammar:

```

CallMemberExpression[Yield, Await] :
  MemberExpression[?Yield, ?Await] Arguments[?Yield, ?Await]

```

### 13.3.1 Static Semantics

#### 13.3.1.1 Static Semantics: Early Errors

```

OptionalChain :
  ?. TemplateLiteral
  OptionalChain TemplateLiteral

```

- It is a Syntax Error if any source text is matched by this production.

**NOTE** This production exists in order to prevent automatic semicolon insertion rules (12.10) from being applied to the following code:

```
a?.b
`c`
```

so that it would be interpreted as two valid statements. The purpose is to maintain consistency with similar code without optional chaining:

```
a.b
`c`
```

which is a valid statement and where automatic semicolon insertion does not apply.

```

ImportMeta :
  import . meta

```

- It is a Syntax Error if the syntactic [goal symbol](#) is not *Module*.

### 13.3.2 Property Accessors

NOTE Properties are accessed by name, using either the dot notation:

*MemberExpression* . *IdentifierName*  
*CallExpression* . *IdentifierName*

or the bracket notation:

*MemberExpression* [*Expression*]  
*CallExpression* [*Expression*]

The dot notation is explained by the following syntactic conversion:

*MemberExpression* . *IdentifierName*  
is identical in its behaviour to

*MemberExpression* [ <*identifier-name-string*> ]  
and similarly

*CallExpression* . *IdentifierName*

is identical in its behaviour to

*CallExpression* [ <*identifier-name-string*> ]

where <*identifier-name-string*> is the result of evaluating [StringValue](#) of *IdentifierName*.

#### 13.3.2.1 Runtime Semantics: Evaluation

*MemberExpression* : *MemberExpression* [ *Expression* ]

1. Let *baseReference* be ? [Evaluation](#) of *MemberExpression*.
2. Let *baseValue* be ? [GetValue](#)(*baseReference*).
3. If the [source text matched by this MemberExpression](#) is [strict mode code](#), let *strict* be **true**; else let *strict* be **false**.
4. Return ? [EvaluatePropertyAccessWithExpressionKey](#)(*baseValue*, *Expression*, *strict*).

*MemberExpression* : *MemberExpression* . *IdentifierName*

1. Let *baseReference* be ? [Evaluation](#) of *MemberExpression*.
2. Let *baseValue* be ? [GetValue](#)(*baseReference*).
3. If the [source text matched by this MemberExpression](#) is [strict mode code](#), let *strict* be **true**; else let *strict* be **false**.
4. Return [EvaluatePropertyAccessWithIdentifierKey](#)(*baseValue*, *IdentifierName*, *strict*).

*MemberExpression* : *MemberExpression* . *PrivateIdentifier*

1. Let *baseReference* be ? [Evaluation](#) of *MemberExpression*.
2. Let *baseValue* be ? [GetValue](#)(*baseReference*).
3. Let *fieldNameString* be the [StringValue](#) of *PrivateIdentifier*.
4. Return [MakePrivateReference](#)(*baseValue*, *fieldNameString*).

*CallExpression* : *CallExpression* [ *Expression* ]

1. Let *baseReference* be ? [Evaluation](#) of *CallExpression*.
2. Let *baseValue* be ? [GetValue](#)(*baseReference*).
3. If the [source text matched by this CallExpression](#) is [strict mode code](#), let *strict* be **true**; else let *strict* be **false**.

- Return ? `EvaluatePropertyAccessWithExpressionKey`(*baseValue*, *Expression*, *strict*).

*CallExpression* : *CallExpression* . *IdentifierName*

- Let *baseReference* be ? `Evaluation` of *CallExpression*.
- Let *baseValue* be ? `GetValue`(*baseReference*).
- If the source text matched by this *CallExpression* is `strict mode code`, let *strict* be `true`; else let *strict* be `false`.
- Return `EvaluatePropertyAccessWithIdentifierKey`(*baseValue*, *IdentifierName*, *strict*).

*CallExpression* : *CallExpression* . *PrivateIdentifier*

- Let *baseReference* be ? `Evaluation` of *CallExpression*.
- Let *baseValue* be ? `GetValue`(*baseReference*).
- Let *fieldNameString* be the `StringValue` of *PrivateIdentifier*.
- Return `MakePrivateReference`(*baseValue*, *fieldNameString*).

### 13.3.3 EvaluatePropertyAccessWithExpressionKey ( *baseValue*, *expression*, *strict* )

The abstract operation `EvaluatePropertyAccessWithExpressionKey` takes arguments *baseValue* (an ECMAScript language value), *expression* (a `Parse Node`), and *strict* (a Boolean) and returns either a `normal completion` containing a `Reference Record` or an `abrupt completion`. It performs the following steps when called:

- Let *propertyNameReference* be ? `Evaluation` of *expression*.
- Let *propertyNameValue* be ? `GetValue`(*propertyNameReference*).
- Let *propertyKey* be ? `ToPropertyKey`(*propertyNameValue*).
- Return the `Reference Record` { `[[Base]]`: *baseValue*, `[[ReferencedName]]`: *propertyKey*, `[[Strict]]`: *strict*, `[[ThisValue]]`: empty }.

### 13.3.4 EvaluatePropertyAccessWithIdentifierKey ( *baseValue*, *identifierName*, *strict* )

The abstract operation `EvaluatePropertyAccessWithIdentifierKey` takes arguments *baseValue* (an ECMAScript language value), *identifierName* (an `IdentifierName Parse Node`), and *strict* (a Boolean) and returns a `Reference Record`. It performs the following steps when called:

- Let *propertyNameString* be `StringValue` of *identifierName*.
- Return the `Reference Record` { `[[Base]]`: *baseValue*, `[[ReferencedName]]`: *propertyNameString*, `[[Strict]]`: *strict*, `[[ThisValue]]`: empty }.

## 13.3.5 The new Operator

### 13.3.5.1 Runtime Semantics: Evaluation

*NewExpression* : `new` *NewExpression*

- Return ? `EvaluateNew`(*NewExpression*, empty).

*MemberExpression* : `new` *MemberExpression* *Arguments*

- Return ? `EvaluateNew`(*MemberExpression*, *Arguments*).

### 13.3.5.1.1 EvaluateNew ( *constructExpr*, *arguments* )

The abstract operation EvaluateNew takes arguments *constructExpr* (a *NewExpression Parse Node* or a *MemberExpression Parse Node*) and *arguments* (empty or an *Arguments Parse Node*) and returns either a *normal completion* containing an ECMAScript language value or an *abrupt completion*. It performs the following steps when called:

1. Let *ref* be ? Evaluation of *constructExpr*.
2. Let *constructor* be ? GetValue(*ref*).
3. If *arguments* is empty, let *argList* be a new empty List.
4. Else,
  - a. Let *argList* be ? ArgumentListEvaluation of *arguments*.
5. If IsConstructor(*constructor*) is **false**, throw a **TypeError** exception.
6. Return ? Construct(*constructor*, *argList*).

## 13.3.6 Function Calls

### 13.3.6.1 Runtime Semantics: Evaluation

*CallExpression* : *CoverCallExpressionAndAsyncArrowHead*

1. Let *expr* be the *CallMemberExpression* that is *covered* by *CoverCallExpressionAndAsyncArrowHead*.
2. Let *memberExpr* be the *MemberExpression* of *expr*.
3. Let *arguments* be the *Arguments* of *expr*.
4. Let *ref* be ? Evaluation of *memberExpr*.
5. Let *func* be ? GetValue(*ref*).
6. If *ref* is a *Reference Record*, IsPropertyReference(*ref*) is **false**, and *ref*.[[ReferencedName]] is **"eval"**, then
  - a. If SameValue(*func*, %eval%) is **true**, then
    - i. Let *argList* be ? ArgumentListEvaluation of *arguments*.
    - ii. If *argList* has no elements, return **undefined**.
    - iii. Let *evalArg* be the first element of *argList*.
    - iv. If the *source text* matched by this *CallExpression* is *strict mode code*, let *strictCaller* be **true**. Otherwise let *strictCaller* be **false**.
    - v. Return ? PerformEval(*evalArg*, *strictCaller*, **true**).
7. Let *thisCall* be this *CallExpression*.
8. Let *tailCall* be IsInTailPosition(*thisCall*).
9. Return ? EvaluateCall(*func*, *ref*, *arguments*, *tailCall*).

A *CallExpression* evaluation that executes step 6.a.v is a *direct eval*.

*CallExpression* : *CallExpression Arguments*

1. Let *ref* be ? Evaluation of *CallExpression*.
2. Let *func* be ? GetValue(*ref*).
3. Let *thisCall* be this *CallExpression*.
4. Let *tailCall* be IsInTailPosition(*thisCall*).
5. Return ? EvaluateCall(*func*, *ref*, *Arguments*, *tailCall*).

### 13.3.6.2 EvaluateCall ( *func*, *ref*, *arguments*, *tailPosition* )

The abstract operation EvaluateCall takes arguments *func* (an ECMAScript language value), *ref* (an ECMAScript language value or a Reference Record), *arguments* (a Parse Node), and *tailPosition* (a Boolean) and returns either a normal completion containing an ECMAScript language value or an abrupt completion. It performs the following steps when called:

1. If *ref* is a Reference Record, then
  - a. If `IsPropertyReference(ref)` is **true**, then
    - i. Let *thisValue* be `GetThisValue(ref)`.
  - b. Else,
    - i. Let *refEnv* be *ref*.[[Base]].
    - ii. Assert: *refEnv* is an Environment Record.
    - iii. Let *thisValue* be *refEnv*.WithBaseObject().
2. Else,
  - a. Let *thisValue* be **undefined**.
3. Let *argList* be ? `ArgumentListEvaluation` of *arguments*.
4. If *func* is not an Object, throw a **TypeError** exception.
5. If `IsCallable(func)` is **false**, throw a **TypeError** exception.
6. If *tailPosition* is **true**, perform `PrepareForTailCall()`.
7. Return ? `Call(func, thisValue, argList)`.

### 13.3.7 The super Keyword

#### 13.3.7.1 Runtime Semantics: Evaluation

*SuperProperty* : **super** [ *Expression* ]

1. Let *env* be `GetThisEnvironment()`.
2. Let *actualThis* be ? *env*.`GetThisBinding()`.
3. Let *propertyNameReference* be ? `Evaluation` of *Expression*.
4. Let *propertyNameValue* be ? `GetValue(propertyNameReference)`.
5. Let *propertyKey* be ? `ToPropertyKey(propertyNameValue)`.
6. If the source text matched by this *SuperProperty* is **strict mode code**, let *strict* be **true**; else let *strict* be **false**.
7. Return ? `MakeSuperPropertyReference(actualThis, propertyKey, strict)`.

*SuperProperty* : **super** . *IdentifierName*

1. Let *env* be `GetThisEnvironment()`.
2. Let *actualThis* be ? *env*.`GetThisBinding()`.
3. Let *propertyKey* be `StringValue` of *IdentifierName*.
4. If the source text matched by this *SuperProperty* is **strict mode code**, let *strict* be **true**; else let *strict* be **false**.
5. Return ? `MakeSuperPropertyReference(actualThis, propertyKey, strict)`.

*SuperCall* : **super** *Arguments*

1. Let *newTarget* be `GetNewTarget()`.
2. **Assert:** *newTarget* is an Object.
3. Let *func* be `GetSuperConstructor()`.
4. Let *argList* be ? `ArgumentListEvaluation` of *Arguments*.
5. If `IsConstructor(func)` is **false**, throw a **TypeError** exception.
6. Let *result* be ? `Construct(func, argList, newTarget)`.
7. Let *thisER* be `GetThisEnvironment()`.
8. Perform ? *thisER*.`BindThisValue(result)`.
9. Let *F* be *thisER*.`[[FunctionObject]]`.
10. **Assert:** *F* is an ECMAScript function object.
11. Perform ? `InitializeInstanceElements(result, F)`.
12. Return *result*.

### 13.3.7.2 GetSuperConstructor ( )

The abstract operation `GetSuperConstructor` takes no arguments and returns an ECMAScript language value. It performs the following steps when called:

1. Let *envRec* be `GetThisEnvironment()`.
2. **Assert:** *envRec* is a Function Environment Record.
3. Let *activeFunction* be *envRec*.`[[FunctionObject]]`.
4. **Assert:** *activeFunction* is an ECMAScript function object.
5. Let *superConstructor* be ! *activeFunction*.`[[GetPrototypeOf]]()`.
6. Return *superConstructor*.

### 13.3.7.3 MakeSuperPropertyReference ( *actualThis*, *propertyKey*, *strict* )

The abstract operation `MakeSuperPropertyReference` takes arguments *actualThis* (an ECMAScript language value), *propertyKey* (a property key), and *strict* (a Boolean) and returns either a normal completion containing a Super Reference Record or a throw completion. It performs the following steps when called:

1. Let *env* be `GetThisEnvironment()`.
2. **Assert:** *env*.`HasSuperBinding()` is **true**.
3. Let *baseValue* be ? *env*.`GetSuperBase()`.
4. Return the Reference Record { `[[Base]]`: *baseValue*, `[[ReferencedName]]`: *propertyKey*, `[[Strict]]`: *strict*, `[[ThisValue]]`: *actualThis* }.

## 13.3.8 Argument Lists

**NOTE** The evaluation of an argument list produces a List of values.

### 13.3.8.1 Runtime Semantics: ArgumentListEvaluation

The syntax-directed operation `ArgumentListEvaluation` takes no arguments and returns either a normal completion containing a List of ECMAScript language values or an abrupt completion. It is defined piecewise over the following productions:

*Arguments* : ( )

1. Return a new empty List.



*ArgumentList* : *AssignmentExpression*

1. Let *ref* be ? *Evaluation* of *AssignmentExpression*.
2. Let *arg* be ? *GetValue*(*ref*).
3. Return « *arg* ».

*ArgumentList* : . . . *AssignmentExpression*

1. Let *list* be a new empty *List*.
2. Let *spreadRef* be ? *Evaluation* of *AssignmentExpression*.
3. Let *spreadObj* be ? *GetValue*(*spreadRef*).
4. Let *iteratorRecord* be ? *GetIterator*(*spreadObj*, sync).
5. Repeat,
  - a. Let *next* be ? *IteratorStep*(*iteratorRecord*).
  - b. If *next* is **false**, return *list*.
  - c. Let *nextArg* be ? *IteratorValue*(*next*).
  - d. Append *nextArg* to *list*.

*ArgumentList* : *ArgumentList* , *AssignmentExpression*

1. Let *precedingArgs* be ? *ArgumentListEvaluation* of *ArgumentList*.
2. Let *ref* be ? *Evaluation* of *AssignmentExpression*.
3. Let *arg* be ? *GetValue*(*ref*).
4. Return the *list-concatenation* of *precedingArgs* and « *arg* ».

*ArgumentList* : *ArgumentList* , . . . *AssignmentExpression*

1. Let *precedingArgs* be ? *ArgumentListEvaluation* of *ArgumentList*.
2. Let *spreadRef* be ? *Evaluation* of *AssignmentExpression*.
3. Let *iteratorRecord* be ? *GetIterator*(? *GetValue*(*spreadRef*), sync).
4. Repeat,
  - a. Let *next* be ? *IteratorStep*(*iteratorRecord*).
  - b. If *next* is **false**, return *precedingArgs*.
  - c. Let *nextArg* be ? *IteratorValue*(*next*).
  - d. Append *nextArg* to *precedingArgs*.

*TemplateLiteral* : *NoSubstitutionTemplate*

1. Let *templateLiteral* be this *TemplateLiteral*.
2. Let *siteObj* be *GetTemplateObject*(*templateLiteral*).
3. Return « *siteObj* ».

*TemplateLiteral* : *SubstitutionTemplate*

1. Let *templateLiteral* be this *TemplateLiteral*.
2. Let *siteObj* be *GetTemplateObject*(*templateLiteral*).
3. Let *remaining* be ? *ArgumentListEvaluation* of *SubstitutionTemplate*.
4. Return the *list-concatenation* of « *siteObj* » and *remaining*.

*SubstitutionTemplate* : *TemplateHead Expression TemplateSpans*

1. Let *firstSubRef* be ? *Evaluation* of *Expression*.
2. Let *firstSub* be ? *GetValue*(*firstSubRef*).
3. Let *restSub* be ? *SubstitutionEvaluation* of *TemplateSpans*.
4. **Assert**: *restSub* is a possibly empty *List*.
5. Return the *list-concatenation* of « *firstSub* » and *restSub*.

### 13.3.9 Optional Chains

**NOTE** An optional chain is a chain of one or more property accesses and function calls, the first of which begins with the token `?.`

#### 13.3.9.1 Runtime Semantics: Evaluation

*OptionalExpression* :

*MemberExpression OptionalChain*

1. Let *baseReference* be ? *Evaluation* of *MemberExpression*.
2. Let *baseValue* be ? *GetValue*(*baseReference*).
3. If *baseValue* is either **undefined** or **null**, then
  - a. Return **undefined**.
4. Return ? *ChainEvaluation* of *OptionalChain* with arguments *baseValue* and *baseReference*.

*OptionalExpression* :

*CallExpression OptionalChain*

1. Let *baseReference* be ? *Evaluation* of *CallExpression*.
2. Let *baseValue* be ? *GetValue*(*baseReference*).
3. If *baseValue* is either **undefined** or **null**, then
  - a. Return **undefined**.
4. Return ? *ChainEvaluation* of *OptionalChain* with arguments *baseValue* and *baseReference*.

*OptionalExpression* :

*OptionalExpression OptionalChain*

1. Let *baseReference* be ? *Evaluation* of *OptionalExpression*.
2. Let *baseValue* be ? *GetValue*(*baseReference*).
3. If *baseValue* is either **undefined** or **null**, then
  - a. Return **undefined**.
4. Return ? *ChainEvaluation* of *OptionalChain* with arguments *baseValue* and *baseReference*.

#### 13.3.9.2 Runtime Semantics: ChainEvaluation

The *syntax-directed operation* *ChainEvaluation* takes arguments *baseValue* (an ECMAScript language value) and *baseReference* (an ECMAScript language value or a Reference Record) and returns either a normal completion containing either an ECMAScript language value or a Reference Record, or an abrupt completion. It is defined piecewise over the following productions:

*OptionalChain* : `?.` *Arguments*

1. Let *thisChain* be this *OptionalChain*.
2. Let *tailCall* be *IsInTailPosition*(*thisChain*).
3. Return ? *EvaluateCall*(*baseValue*, *baseReference*, *Arguments*, *tailCall*).

*OptionalChain* : `?.` [ *Expression* ]

1. If the source text matched by this *OptionalChain* is *strict mode code*, let *strict* be **true**; else let *strict* be **false**.
2. Return ? *EvaluatePropertyAccessWithExpressionKey*(*baseValue*, *Expression*, *strict*).

*OptionalChain* : ? . *IdentifierName*

1. If the source text matched by this *OptionalChain* is strict mode code, let *strict* be **true**; else let *strict* be **false**.
2. Return `EvaluatePropertyAccessWithIdentifierKey(baseValue, IdentifierName, strict)`.

*OptionalChain* : ? . *PrivateIdentifier*

1. Let *fieldNameString* be the `StringValue` of *PrivateIdentifier*.
2. Return `MakePrivateReference(baseValue, fieldNameString)`.

*OptionalChain* : *OptionalChain Arguments*

1. Let *optionalChain* be *OptionalChain*.
2. Let *newReference* be ? `ChainEvaluation` of *optionalChain* with arguments *baseValue* and *baseReference*.
3. Let *newValue* be ? `GetValue(newReference)`.
4. Let *thisChain* be this *OptionalChain*.
5. Let *tailCall* be `IsInTailPosition(thisChain)`.
6. Return ? `EvaluateCall(newValue, newReference, Arguments, tailCall)`.

*OptionalChain* : *OptionalChain* [ *Expression* ]

1. Let *optionalChain* be *OptionalChain*.
2. Let *newReference* be ? `ChainEvaluation` of *optionalChain* with arguments *baseValue* and *baseReference*.
3. Let *newValue* be ? `GetValue(newReference)`.
4. If the source text matched by this *OptionalChain* is strict mode code, let *strict* be **true**; else let *strict* be **false**.
5. Return ? `EvaluatePropertyAccessWithExpressionKey(newValue, Expression, strict)`.

*OptionalChain* : *OptionalChain* . *IdentifierName*

1. Let *optionalChain* be *OptionalChain*.
2. Let *newReference* be ? `ChainEvaluation` of *optionalChain* with arguments *baseValue* and *baseReference*.
3. Let *newValue* be ? `GetValue(newReference)`.
4. If the source text matched by this *OptionalChain* is strict mode code, let *strict* be **true**; else let *strict* be **false**.
5. Return `EvaluatePropertyAccessWithIdentifierKey(newValue, IdentifierName, strict)`.

*OptionalChain* : *OptionalChain* . *PrivateIdentifier*

1. Let *optionalChain* be *OptionalChain*.
2. Let *newReference* be ? `ChainEvaluation` of *optionalChain* with arguments *baseValue* and *baseReference*.
3. Let *newValue* be ? `GetValue(newReference)`.
4. Let *fieldNameString* be the `StringValue` of *PrivateIdentifier*.
5. Return `MakePrivateReference(newValue, fieldNameString)`.

## 13.3.10 Import Calls

### 13.3.10.1 Runtime Semantics: Evaluation

*ImportCall* : **import** ( *AssignmentExpression* )

1. Let *referrer* be `GetActiveScriptOrModule()`.
2. If *referrer* is **null**, set *referrer* to the current Realm Record.
3. Let *argRef* be ? *Evaluation of AssignmentExpression*.
4. Let *specifier* be ? `GetValue(argRef)`.
5. Let *promiseCapability* be ! `NewPromiseCapability(%Promise%)`.
6. Let *specifierString* be `Completion(ToString(specifier))`.
7. `IfAbruptRejectPromise(specifierString, promiseCapability)`.
8. Perform `HostLoadImportedModule(referrer, specifierString, empty, promiseCapability)`.
9. Return *promiseCapability*.[[Promise]].

### 13.3.10.1.1 ContinueDynamicImport ( *promiseCapability*, *moduleCompletion* )

The abstract operation `ContinueDynamicImport` takes arguments *promiseCapability* (a *PromiseCapability Record*) and *moduleCompletion* (either a *normal completion* containing a *Module Record* or a *throw completion*) and returns unused. It completes the process of a dynamic import originally started by an `import()` call, resolving or rejecting the promise returned by that call as appropriate. It performs the following steps when called:

1. If *moduleCompletion* is an *abrupt completion*, then
  - a. Perform ! `Call(promiseCapability.[[Reject]], undefined, « moduleCompletion.[[Value]] »)`.
  - b. Return unused.
2. Let *module* be *moduleCompletion*.[[Value]].
3. Let *loadPromise* be *module*.`LoadRequestedModules()`.
4. Let *rejectedClosure* be a new *Abstract Closure* with parameters (*reason*) that captures *promiseCapability* and performs the following steps when called:
  - a. Perform ! `Call(promiseCapability.[[Reject]], undefined, « reason »)`.
  - b. Return unused.
5. Let *onRejected* be `CreateBuiltinFunction(rejectedClosure, 1, "", « »)`.
6. Let *linkAndEvaluateClosure* be a new *Abstract Closure* with no parameters that captures *module*, *promiseCapability*, and *onRejected* and performs the following steps when called:
  - a. Let *link* be `Completion(module.Link())`.
  - b. If *link* is an *abrupt completion*, then
    - i. Perform ! `Call(promiseCapability.[[Reject]], undefined, « link.[[Value]] »)`.
    - ii. Return unused.
  - c. Let *evaluatePromise* be *module*.`Evaluate()`.
  - d. Let *fulfilledClosure* be a new *Abstract Closure* with no parameters that captures *module* and *promiseCapability* and performs the following steps when called:
    - i. Let *namespace* be `GetModuleNamespace(module)`.
    - ii. Perform ! `Call(promiseCapability.[[Resolve]], undefined, « namespace »)`.
    - iii. Return unused.
  - e. Let *onFulfilled* be `CreateBuiltinFunction(fulfilledClosure, 0, "", « »)`.
  - f. Perform `PerformPromiseThen(evaluatePromise, onFulfilled, onRejected)`.
  - g. Return unused.
7. Let *linkAndEvaluate* be `CreateBuiltinFunction(linkAndEvaluateClosure, 0, "", « »)`.
8. Perform `PerformPromiseThen(loadPromise, linkAndEvaluate, onRejected)`.
9. Return unused.

### 13.3.11 Tagged Templates

**NOTE** A tagged template is a function call where the arguments of the call are derived from a *TemplateLiteral* (13.2.8). The actual arguments include a template object (13.2.8.4) and the values produced by evaluating the expressions embedded within the *TemplateLiteral*.

#### 13.3.11.1 Runtime Semantics: Evaluation

*MemberExpression* : *MemberExpression* *TemplateLiteral*

1. Let *tagRef* be ? *Evaluation* of *MemberExpression*.
2. Let *tagFunc* be ? *GetValue*(*tagRef*).
3. Let *thisCall* be this *MemberExpression*.
4. Let *tailCall* be *IsInTailPosition*(*thisCall*).
5. Return ? *EvaluateCall*(*tagFunc*, *tagRef*, *TemplateLiteral*, *tailCall*).

*CallExpression* : *CallExpression* *TemplateLiteral*

1. Let *tagRef* be ? *Evaluation* of *CallExpression*.
2. Let *tagFunc* be ? *GetValue*(*tagRef*).
3. Let *thisCall* be this *CallExpression*.
4. Let *tailCall* be *IsInTailPosition*(*thisCall*).
5. Return ? *EvaluateCall*(*tagFunc*, *tagRef*, *TemplateLiteral*, *tailCall*).

### 13.3.12 Meta Properties

#### 13.3.12.1 Runtime Semantics: Evaluation

*NewTarget* : **new** . **target**

1. Return *GetNewTarget*().

*ImportMeta* : **import** . **meta**

1. Let *module* be *GetActiveScriptOrModule*().
2. **Assert**: *module* is a *Source Text Module Record*.
3. Let *importMeta* be *module*.[[*ImportMeta*]].
4. If *importMeta* is empty, then
  - a. Set *importMeta* to *OrdinaryObjectCreate*(**null**).
  - b. Let *importMetaValues* be *HostGetImportMetaProperties*(*module*).
  - c. For each *Record* { [[*Key*]], [[*Value*]] } *p* of *importMetaValues*, do
    - i. Perform ! *CreateDataPropertyOrThrow*(*importMeta*, *p*.[[*Key*]], *p*.[[*Value*]]).
  - d. Perform *HostFinalizeImportMeta*(*importMeta*, *module*).
  - e. Set *module*.[[*ImportMeta*]] to *importMeta*.
  - f. Return *importMeta*.
5. Else,
  - a. **Assert**: *importMeta* is an *Object*.
  - b. Return *importMeta*.

### 13.3.12.1.1 HostGetImportMetaProperties ( *moduleRecord* )

The *host-defined* abstract operation HostGetImportMetaProperties takes argument *moduleRecord* (a *Module Record*) and returns a *List* of *Records* with fields *[[Key]]* (a *property key*) and *[[Value]]* (an *ECMAScript language value*). It allows *hosts* to provide *property keys* and values for the object returned from *import.meta*.

An implementation of HostGetImportMetaProperties must conform to the following requirements:

- It must return a *List* whose values are all *Records* with two fields, *[[Key]]* and *[[Value]]*.
- Each such *Record*'s *[[Key]]* field must be a *property key*, i.e., *IsPropertyKey* must return **true** when applied to it.
- Each such *Record*'s *[[Value]]* field must be an *ECMAScript language value*.

The default implementation of HostGetImportMetaProperties is to return a new empty *List*.

### 13.3.12.1.2 HostFinalizeImportMeta ( *importMeta*, *moduleRecord* )

The *host-defined* abstract operation HostFinalizeImportMeta takes arguments *importMeta* (an *Object*) and *moduleRecord* (a *Module Record*) and returns *unused*. It allows *hosts* to perform any extraordinary operations to prepare the object returned from *import.meta*.

Most *hosts* will be able to simply define *HostGetImportMetaProperties*, and leave *HostFinalizeImportMeta* with its default behaviour. However, *HostFinalizeImportMeta* provides an "escape hatch" for *hosts* which need to directly manipulate the object before it is exposed to *ECMAScript* code.

An implementation of HostFinalizeImportMeta must conform to the following requirements:

- It must return *unused*.

The default implementation of HostFinalizeImportMeta is to return *unused*.

## 13.4 Update Expressions

### Syntax

```

UpdateExpression[Yield, Await] :
    LeftHandSideExpression[?Yield, ?Await]
    LeftHandSideExpression[?Yield, ?Await] [no LineTerminator here] ++
    LeftHandSideExpression[?Yield, ?Await] [no LineTerminator here] --
    ++ UnaryExpression[?Yield, ?Await]
    -- UnaryExpression[?Yield, ?Await]

```

### 13.4.1 Static Semantics: Early Errors

```

UpdateExpression :
    LeftHandSideExpression ++
    LeftHandSideExpression --

```

- It is an early Syntax Error if *AssignmentTargetType* of *LeftHandSideExpression* is not simple.

```

UpdateExpression :
    ++ UnaryExpression
    -- UnaryExpression

```

- It is an early Syntax Error if *AssignmentTargetType* of *UnaryExpression* is not simple.

## 13.4.2 Postfix Increment Operator

### 13.4.2.1 Runtime Semantics: Evaluation

*UpdateExpression* : *LeftHandSideExpression* ++

1. Let *lhs* be ? *Evaluation* of *LeftHandSideExpression*.
2. Let *oldValue* be ? *ToNumeric*(? *GetValue*(*lhs*)).
3. If *oldValue* is a *Number*, then
  - a. Let *newValue* be *Number::add*(*oldValue*, 1<sub>F</sub>).
4. Else,
  - a. *Assert*: *oldValue* is a *BigInt*.
  - b. Let *newValue* be *BigInt::add*(*oldValue*, 1<sub>Z</sub>).
5. Perform ? *PutValue*(*lhs*, *newValue*).
6. Return *oldValue*.

## 13.4.3 Postfix Decrement Operator

### 13.4.3.1 Runtime Semantics: Evaluation

*UpdateExpression* : *LeftHandSideExpression* --

1. Let *lhs* be ? *Evaluation* of *LeftHandSideExpression*.
2. Let *oldValue* be ? *ToNumeric*(? *GetValue*(*lhs*)).
3. If *oldValue* is a *Number*, then
  - a. Let *newValue* be *Number::subtract*(*oldValue*, 1<sub>F</sub>).
4. Else,
  - a. *Assert*: *oldValue* is a *BigInt*.
  - b. Let *newValue* be *BigInt::subtract*(*oldValue*, 1<sub>Z</sub>).
5. Perform ? *PutValue*(*lhs*, *newValue*).
6. Return *oldValue*.

## 13.4.4 Prefix Increment Operator

### 13.4.4.1 Runtime Semantics: Evaluation

*UpdateExpression* : ++ *UnaryExpression*

1. Let *expr* be ? *Evaluation* of *UnaryExpression*.
2. Let *oldValue* be ? *ToNumeric*(? *GetValue*(*expr*)).
3. If *oldValue* is a *Number*, then
  - a. Let *newValue* be *Number::add*(*oldValue*, 1<sub>F</sub>).
4. Else,
  - a. *Assert*: *oldValue* is a *BigInt*.
  - b. Let *newValue* be *BigInt::add*(*oldValue*, 1<sub>Z</sub>).
5. Perform ? *PutValue*(*expr*, *newValue*).
6. Return *newValue*.

## 13.4.5 Prefix Decrement Operator

### 13.4.5.1 Runtime Semantics: Evaluation

*UpdateExpression* : -- *UnaryExpression*

1. Let *expr* be ? *Evaluation* of *UnaryExpression*.
2. Let *oldValue* be ? *ToNumeric*(? *GetValue*(*expr*)).
3. If *oldValue* is a *Number*, then
  - a. Let *newValue* be *Number*::*subtract*(*oldValue*, 1<sub>F</sub>).
4. Else,
  - a. *Assert*: *oldValue* is a *BigInt*.
  - b. Let *newValue* be *BigInt*::*subtract*(*oldValue*, 1<sub>Z</sub>).
5. Perform ? *PutValue*(*expr*, *newValue*).
6. Return *newValue*.

## 13.5 Unary Operators

### Syntax

```

UnaryExpression[Yield, Await] :
  UpdateExpression[?Yield, ?Await]
  delete UnaryExpression[?Yield, ?Await]
  void UnaryExpression[?Yield, ?Await]
  typeof UnaryExpression[?Yield, ?Await]
  + UnaryExpression[?Yield, ?Await]
  - UnaryExpression[?Yield, ?Await]
  ~ UnaryExpression[?Yield, ?Await]
  ! UnaryExpression[?Yield, ?Await]
  [+Await] AwaitExpression[?Yield]

```

### 13.5.1 The delete Operator

#### 13.5.1.1 Static Semantics: Early Errors

*UnaryExpression* : **delete** *UnaryExpression*

- It is a Syntax Error if the *UnaryExpression* is contained in *strict mode code* and the derived *UnaryExpression* is *PrimaryExpression* : *IdentifierReference* , *MemberExpression* : *MemberExpression* . *PrivateIdentifier* , *CallExpression* : *CallExpression* . *PrivateIdentifier* , *OptionalChain* : ? . *PrivateIdentifier* , or *OptionalChain* : *OptionalChain* . *PrivateIdentifier* .
- It is a Syntax Error if the derived *UnaryExpression* is *PrimaryExpression* : *CoverParenthesizedExpressionAndArrowParameterList* and *CoverParenthesizedExpressionAndArrowParameterList* ultimately derives a phrase that, if used in place of *UnaryExpression*, would produce a Syntax Error according to these rules. This rule is recursively applied.



NOTE The last rule means that expressions such as `delete (((foo)))` produce [early errors](#) because of recursive application of the first rule.

### 13.5.1.2 Runtime Semantics: Evaluation

*UnaryExpression* : **delete** *UnaryExpression*

1. Let *ref* be ? [Evaluation](#) of *UnaryExpression*.
2. If *ref* is not a [Reference Record](#), return **true**.
3. If [IsUnresolvableReference](#)(*ref*) is **true**, then
  - a. **Assert**: *ref*.[[Strict]] is **false**.
  - b. Return **true**.
4. If [IsPropertyReference](#)(*ref*) is **true**, then
  - a. **Assert**: [IsPrivateReference](#)(*ref*) is **false**.
  - b. If [IsSuperReference](#)(*ref*) is **true**, throw a **ReferenceError** exception.
  - c. Let *baseObj* be ? [ToObject](#)(*ref*.[[Base]]).
  - d. Let *deleteStatus* be ? *baseObj*.[[Delete]](*ref*.[[ReferencedName]]).
  - e. If *deleteStatus* is **false** and *ref*.[[Strict]] is **true**, throw a **TypeError** exception.
  - f. Return *deleteStatus*.
5. Else,
  - a. Let *base* be *ref*.[[Base]].
  - b. **Assert**: *base* is an [Environment Record](#).
  - c. Return ? *base*.DeleteBinding(*ref*.[[ReferencedName]]).

NOTE 1 When a **delete** operator occurs within [strict mode code](#), a **SyntaxError** exception is thrown if its *UnaryExpression* is a direct reference to a variable, function argument, or function name. In addition, if a **delete** operator occurs within [strict mode code](#) and the property to be deleted has the attribute { [[Configurable]]: **false** } (or otherwise cannot be deleted), a **TypeError** exception is thrown.

NOTE 2 The object that may be created in step 4.c is not accessible outside of the above abstract operation and the [ordinary object](#) [[Delete]] internal method. An implementation might choose to avoid the actual creation of that object.

## 13.5.2 The void Operator

### 13.5.2.1 Runtime Semantics: Evaluation

*UnaryExpression* : **void** *UnaryExpression*

1. Let *expr* be ? [Evaluation](#) of *UnaryExpression*.
2. Perform ? [GetValue](#)(*expr*).
3. Return **undefined**.

NOTE [GetValue](#) must be called even though its value is not used because it may have observable side-effects.

## 13.5.3 The typeof Operator

### 13.5.3.1 Runtime Semantics: Evaluation

*UnaryExpression* : **typeof** *UnaryExpression*

1. Let *val* be ? [Evaluation](#) of *UnaryExpression*.
2. If *val* is a [Reference Record](#), then
  - a. If [IsUnresolvableReference](#)(*val*) is **true**, return **"undefined"**.
3. Set *val* to ? [GetValue](#)(*val*).
4. If *val* is **undefined**, return **"undefined"**.
5. If *val* is **null**, return **"object"**.
6. If *val* is a [String](#), return **"string"**.
7. If *val* is a [Symbol](#), return **"symbol"**.
8. If *val* is a [Boolean](#), return **"boolean"**.
9. If *val* is a [Number](#), return **"number"**.
10. If *val* is a [BigInt](#), return **"bigint"**.
11. [Assert](#): *val* is an [Object](#).
12. NOTE: This step is replaced in section [B.3.6.3](#).
13. If *val* has a [\[\[Call\]\]](#) internal slot, return **"function"**.
14. Return **"object"**.

## 13.5.4 Unary + Operator

NOTE The unary + operator converts its operand to [Number type](#).

### 13.5.4.1 Runtime Semantics: Evaluation

*UnaryExpression* : + *UnaryExpression*

1. Let *expr* be ? [Evaluation](#) of *UnaryExpression*.
2. Return ? [ToNumber](#)(? [GetValue](#)(*expr*)).

## 13.5.5 Unary – Operator

NOTE The unary – operator converts its operand to a numeric value and then negates it. Negating  $+0_{\text{F}}$  produces  $-0_{\text{F}}$ , and negating  $-0_{\text{F}}$  produces  $+0_{\text{F}}$ .

### 13.5.5.1 Runtime Semantics: Evaluation

*UnaryExpression* : – *UnaryExpression*

1. Let *expr* be ? [Evaluation](#) of *UnaryExpression*.
2. Let *oldValue* be ? [ToNumeric](#)(? [GetValue](#)(*expr*)).
3. If *oldValue* is a [Number](#), then
  - a. Return [Number::unaryMinus](#)(*oldValue*).
4. Else,
  - a. [Assert](#): *oldValue* is a [BigInt](#).
  - b. Return [BigInt::unaryMinus](#)(*oldValue*).

## 13.5.6 Bitwise NOT Operator ( ~ )

### 13.5.6.1 Runtime Semantics: Evaluation

*UnaryExpression* : ~ *UnaryExpression*

1. Let *expr* be ? *Evaluation* of *UnaryExpression*.
2. Let *oldValue* be ? *ToNumeric*(? *GetValue*(*expr*)).
3. If *oldValue* is a *Number*, then
  - a. Return *Number*::*bitwiseNOT*(*oldValue*).
4. Else,
  - a. *Assert*: *oldValue* is a *BigInt*.
  - b. Return *BigInt*::*bitwiseNOT*(*oldValue*).

## 13.5.7 Logical NOT Operator ( ! )

### 13.5.7.1 Runtime Semantics: Evaluation

*UnaryExpression* : ! *UnaryExpression*

1. Let *expr* be ? *Evaluation* of *UnaryExpression*.
2. Let *oldValue* be *ToBoolean*(? *GetValue*(*expr*)).
3. If *oldValue* is **true**, return **false**.
4. Return **true**.

## 13.6 Exponentiation Operator

### Syntax

```

ExponentiationExpression[Yield, Await] :
  UnaryExpression[?Yield, ?Await]
  UpdateExpression[?Yield, ?Await] ** ExponentiationExpression[?Yield, ?Await]
  
```

### 13.6.1 Runtime Semantics: Evaluation

*ExponentiationExpression* : *UpdateExpression* \*\* *ExponentiationExpression*

1. Return ? *EvaluateStringOrNumericBinaryExpression*(*UpdateExpression*, \*\*, *ExponentiationExpression*).

## 13.7 Multiplicative Operators

### Syntax

```

MultiplicativeExpression[Yield, Await] :
  ExponentiationExpression[?Yield, ?Await]
  
```

$$\text{MultiplicativeExpression}_{[?Yield, ?Await]} \text{ MultiplicativeOperator} \\ \text{ExponentiationExpression}_{[?Yield, ?Await]}$$

*MultiplicativeOperator* : **one of**  
\* / %

#### NOTE

- The \* operator performs multiplication, producing the product of its operands.
- The / operator performs division, producing the quotient of its operands.
- The % operator yields the remainder of its operands from an implied division.

### 13.7.1 Runtime Semantics: Evaluation

*MultiplicativeExpression* : *MultiplicativeExpression MultiplicativeOperator ExponentiationExpression*

1. Let *opText* be the [source text matched by MultiplicativeOperator](#).
2. Return ? [EvaluateStringOrNumericBinaryExpression](#)(*MultiplicativeExpression*, *opText*, *ExponentiationExpression*).

## 13.8 Additive Operators

### Syntax

$$\text{AdditiveExpression}_{[Yield, Await]} : \\ \text{MultiplicativeExpression}_{[?Yield, ?Await]} \\ \text{AdditiveExpression}_{[?Yield, ?Await]} + \text{MultiplicativeExpression}_{[?Yield, ?Await]} \\ \text{AdditiveExpression}_{[?Yield, ?Await]} - \text{MultiplicativeExpression}_{[?Yield, ?Await]}$$

### 13.8.1 The Addition Operator ( + )

NOTE The addition operator either performs string concatenation or numeric addition.

#### 13.8.1.1 Runtime Semantics: Evaluation

*AdditiveExpression* : *AdditiveExpression + MultiplicativeExpression*

1. Return ? [EvaluateStringOrNumericBinaryExpression](#)(*AdditiveExpression*, +, *MultiplicativeExpression*).

### 13.8.2 The Subtraction Operator ( - )

NOTE The - operator performs subtraction, producing the difference of its operands.

#### 13.8.2.1 Runtime Semantics: Evaluation

*AdditiveExpression* : *AdditiveExpression - MultiplicativeExpression*

1. Return ? [EvaluateStringOrNumericBinaryExpression](#)(*AdditiveExpression*, -, *MultiplicativeExpression*).

## 13.9 Bitwise Shift Operators

### Syntax

```
ShiftExpression[Yield, Await] :  
  AdditiveExpression[?Yield, ?Await]  
  ShiftExpression[?Yield, ?Await] << AdditiveExpression[?Yield, ?Await]  
  ShiftExpression[?Yield, ?Await] >> AdditiveExpression[?Yield, ?Await]  
  ShiftExpression[?Yield, ?Await] >>> AdditiveExpression[?Yield, ?Await]
```

### 13.9.1 The Left Shift Operator ( << )

**NOTE** Performs a bitwise left shift operation on the left operand by the amount specified by the right operand.

#### 13.9.1.1 Runtime Semantics: Evaluation

*ShiftExpression* : *ShiftExpression* << *AdditiveExpression*

1. Return ? [EvaluateStringOrNumericBinaryExpression](#)(*ShiftExpression*, <<, *AdditiveExpression*).

### 13.9.2 The Signed Right Shift Operator ( >> )

**NOTE** Performs a sign-filling bitwise right shift operation on the left operand by the amount specified by the right operand.

#### 13.9.2.1 Runtime Semantics: Evaluation

*ShiftExpression* : *ShiftExpression* >> *AdditiveExpression*

1. Return ? [EvaluateStringOrNumericBinaryExpression](#)(*ShiftExpression*, >>, *AdditiveExpression*).

### 13.9.3 The Unsigned Right Shift Operator ( >>> )

**NOTE** Performs a zero-filling bitwise right shift operation on the left operand by the amount specified by the right operand.

#### 13.9.3.1 Runtime Semantics: Evaluation

*ShiftExpression* : *ShiftExpression* >>> *AdditiveExpression*

1. Return ? [EvaluateStringOrNumericBinaryExpression](#)(*ShiftExpression*, >>>, *AdditiveExpression*).

## 13.10 Relational Operators

NOTE 1 The result of evaluating a relational operator is always of type Boolean, reflecting whether the relationship named by the operator holds between its two operands.

### Syntax

```

RelationalExpression[In, Yield, Await] :
  ShiftExpression[?Yield, ?Await]
  RelationalExpression[?In, ?Yield, ?Await] < ShiftExpression[?Yield, ?Await]
  RelationalExpression[?In, ?Yield, ?Await] > ShiftExpression[?Yield, ?Await]
  RelationalExpression[?In, ?Yield, ?Await] <= ShiftExpression[?Yield, ?Await]
  RelationalExpression[?In, ?Yield, ?Await] >= ShiftExpression[?Yield, ?Await]
  RelationalExpression[?In, ?Yield, ?Await] instanceof
    ShiftExpression[?Yield, ?Await]
  [+In] RelationalExpression[+In, ?Yield, ?Await] in ShiftExpression[?Yield, ?Await]
  [+In] PrivateIdentifier in ShiftExpression[?Yield, ?Await]

```

NOTE 2 The <sub>[In]</sub> grammar parameter is needed to avoid confusing the **in** operator in a relational expression with the **in** operator in a **for** statement.

### 13.10.1 Runtime Semantics: Evaluation

*RelationalExpression* : *RelationalExpression* < *ShiftExpression*

1. Let *lref* be ? [Evaluation](#) of *RelationalExpression*.
2. Let *lval* be ? [GetValue](#)(*lref*).
3. Let *rref* be ? [Evaluation](#) of *ShiftExpression*.
4. Let *rval* be ? [GetValue](#)(*rref*).
5. Let *r* be ? [IsLessThan](#)(*lval*, *rval*, **true**).
6. If *r* is **undefined**, return **false**. Otherwise, return *r*.

*RelationalExpression* : *RelationalExpression* > *ShiftExpression*

1. Let *lref* be ? [Evaluation](#) of *RelationalExpression*.
2. Let *lval* be ? [GetValue](#)(*lref*).
3. Let *rref* be ? [Evaluation](#) of *ShiftExpression*.
4. Let *rval* be ? [GetValue](#)(*rref*).
5. Let *r* be ? [IsLessThan](#)(*rval*, *lval*, **false**).
6. If *r* is **undefined**, return **false**. Otherwise, return *r*.

*RelationalExpression* : *RelationalExpression* <= *ShiftExpression*

1. Let *lref* be ? [Evaluation](#) of *RelationalExpression*.
2. Let *lval* be ? [GetValue](#)(*lref*).
3. Let *rref* be ? [Evaluation](#) of *ShiftExpression*.
4. Let *rval* be ? [GetValue](#)(*rref*).
5. Let *r* be ? [IsLessThan](#)(*rval*, *lval*, **false**).
6. If *r* is either **true** or **undefined**, return **false**. Otherwise, return **true**.

*RelationalExpression* : *RelationalExpression* >= *ShiftExpression*

1. Let *lref* be ? Evaluation of *RelationalExpression*.
2. Let *lval* be ? GetValue(*lref*).
3. Let *rref* be ? Evaluation of *ShiftExpression*.
4. Let *rval* be ? GetValue(*rref*).
5. Let *r* be ? IsLessThan(*lval*, *rval*, true).
6. If *r* is either **true** or **undefined**, return **false**. Otherwise, return **true**.

*RelationalExpression* : *RelationalExpression* **instanceof** *ShiftExpression*

1. Let *lref* be ? Evaluation of *RelationalExpression*.
2. Let *lval* be ? GetValue(*lref*).
3. Let *rref* be ? Evaluation of *ShiftExpression*.
4. Let *rval* be ? GetValue(*rref*).
5. Return ? InstanceofOperator(*lval*, *rval*).

*RelationalExpression* : *RelationalExpression* **in** *ShiftExpression*

1. Let *lref* be ? Evaluation of *RelationalExpression*.
2. Let *lval* be ? GetValue(*lref*).
3. Let *rref* be ? Evaluation of *ShiftExpression*.
4. Let *rval* be ? GetValue(*rref*).
5. If *rval* is not an Object, throw a **TypeError** exception.
6. Return ? HasProperty(*rval*, ? ToPropertyKey(*lval*)).

*RelationalExpression* : *PrivateIdentifier* **in** *ShiftExpression*

1. Let *privateIdentifier* be the *StringValue* of *PrivateIdentifier*.
2. Let *rref* be ? Evaluation of *ShiftExpression*.
3. Let *rval* be ? GetValue(*rref*).
4. If *rval* is not an Object, throw a **TypeError** exception.
5. Let *privateEnv* be the running execution context's PrivateEnvironment.
6. Let *privateName* be ResolvePrivateIdentifier(*privateEnv*, *privateIdentifier*).
7. If PrivateElementFind(*rval*, *privateName*) is not empty, return **true**.
8. Return **false**.

### 13.10.2 InstanceofOperator ( *V*, *target* )

The abstract operation InstanceofOperator takes arguments *V* (an ECMAScript language value) and *target* (an ECMAScript language value) and returns either a normal completion containing a Boolean or a throw completion. It implements the generic algorithm for determining if *V* is an instance of *target* either by consulting *target*'s @@hasInstance method or, if absent, determining whether the value of *target*'s "prototype" property is present in *V*'s prototype chain. It performs the following steps when called:

1. If *target* is not an Object, throw a **TypeError** exception.
2. Let *instOfHandler* be ? GetMethod(*target*, @@hasInstance).
3. If *instOfHandler* is not **undefined**, then
  - a. Return ToBoolean(? Call(*instOfHandler*, *target*, « *V* »)).
4. If IsCallable(*target*) is **false**, throw a **TypeError** exception.
5. Return ? OrdinaryHasInstance(*target*, *V*).

**NOTE** Steps 4 and 5 provide compatibility with previous editions of ECMAScript that did not use a @@hasInstance method to define the **instanceof** operator semantics. If an object does not define or inherit @@hasInstance it uses the default **instanceof** semantics.

## 13.11 Equality Operators

**NOTE** The result of evaluating an equality operator is always of type Boolean, reflecting whether the relationship named by the operator holds between its two operands.

### Syntax

```

EqualityExpression[In, Yield, Await] :
    RelationalExpression[?In, ?Yield, ?Await]
EqualityExpression[?In, ?Yield, ?Await] ==
    RelationalExpression[?In, ?Yield, ?Await]
EqualityExpression[?In, ?Yield, ?Await] !=
    RelationalExpression[?In, ?Yield, ?Await]
EqualityExpression[?In, ?Yield, ?Await] ===
    RelationalExpression[?In, ?Yield, ?Await]
EqualityExpression[?In, ?Yield, ?Await] !==
    RelationalExpression[?In, ?Yield, ?Await]

```

### 13.11.1 Runtime Semantics: Evaluation

*EqualityExpression* : *EqualityExpression* == *RelationalExpression*

1. Let *lref* be ? [Evaluation](#) of *EqualityExpression*.
2. Let *lval* be ? [GetValue](#)(*lref*).
3. Let *rref* be ? [Evaluation](#) of *RelationalExpression*.
4. Let *rval* be ? [GetValue](#)(*rref*).
5. Return ? [IsLooselyEqual](#)(*rval*, *lval*).

*EqualityExpression* : *EqualityExpression* != *RelationalExpression*

1. Let *lref* be ? [Evaluation](#) of *EqualityExpression*.
2. Let *lval* be ? [GetValue](#)(*lref*).
3. Let *rref* be ? [Evaluation](#) of *RelationalExpression*.
4. Let *rval* be ? [GetValue](#)(*rref*).
5. Let *r* be ? [IsLooselyEqual](#)(*rval*, *lval*).
6. If *r* is **true**, return **false**. Otherwise, return **true**.

*EqualityExpression* : *EqualityExpression* === *RelationalExpression*

1. Let *lref* be ? [Evaluation](#) of *EqualityExpression*.
2. Let *lval* be ? [GetValue](#)(*lref*).
3. Let *rref* be ? [Evaluation](#) of *RelationalExpression*.
4. Let *rval* be ? [GetValue](#)(*rref*).
5. Return [IsStrictlyEqual](#)(*rval*, *lval*).

*EqualityExpression* : *EqualityExpression* !== *RelationalExpression*



1. Let *lref* be ? [Evaluation](#) of *EqualityExpression*.
2. Let *lval* be ? [GetValue](#)(*lref*).
3. Let *rref* be ? [Evaluation](#) of *RelationalExpression*.
4. Let *rval* be ? [GetValue](#)(*rref*).
5. Let *r* be [IsStrictlyEqual](#)(*rval*, *lval*).
6. If *r* is **true**, return **false**. Otherwise, return **true**.

NOTE 1 Given the above definition of equality:

- String comparison can be forced by: ``${a}` == `${b}``.
- Numeric comparison can be forced by: `+a == +b`.
- Boolean comparison can be forced by: `!a == !b`.

NOTE 2 The equality operators maintain the following invariants:

- `A != B` is equivalent to `!(A == B)`.
- `A == B` is equivalent to `B == A`, except in the order of evaluation of **A** and **B**.

NOTE 3 The equality operator is not always transitive. For example, there might be two distinct String objects, each representing the same String value; each String object would be considered equal to the String value by the `==` operator, but the two String objects would not be equal to each other. For example:

- `new String("a") == "a"` and `"a" == new String("a")` are both **true**.
- `new String("a") == new String("a")` is **false**.

NOTE 4 Comparison of Strings uses a simple equality test on sequences of code unit values. There is no attempt to use the more complex, semantically oriented definitions of character or string equality and collating order defined in the Unicode specification. Therefore Strings values that are canonically equal according to the Unicode Standard could test as unequal. In effect this algorithm assumes that both Strings are already in normalized form.

## 13.12 Binary Bitwise Operators

### Syntax

```

BitwiseANDExpression[In, Yield, Await] :
    EqualityExpression[?In, ?Yield, ?Await]
    BitwiseANDExpression[?In, ?Yield, ?Await] &
    EqualityExpression[?In, ?Yield, ?Await]

BitwiseXORExpression[In, Yield, Await] :
    BitwiseANDExpression[?In, ?Yield, ?Await]
    BitwiseXORExpression[?In, ?Yield, ?Await] ^
    BitwiseANDExpression[?In, ?Yield, ?Await]

BitwiseORExpression[In, Yield, Await] :
    BitwiseXORExpression[?In, ?Yield, ?Await]
    BitwiseORExpression[?In, ?Yield, ?Await] |
    BitwiseXORExpression[?In, ?Yield, ?Await]

```

### 13.12.1 Runtime Semantics: Evaluation

*BitwiseANDExpression* : *BitwiseANDExpression* & *EqualityExpression*

1. Return ? *EvaluateStringOrNumericBinaryExpression*(*BitwiseANDExpression*, &, *EqualityExpression*).

*BitwiseXORExpression* : *BitwiseXORExpression* ^ *BitwiseANDExpression*

1. Return ? *EvaluateStringOrNumericBinaryExpression*(*BitwiseXORExpression*, ^, *BitwiseANDExpression*).

*BitwiseORExpression* : *BitwiseORExpression* | *BitwiseXORExpression*

1. Return ? *EvaluateStringOrNumericBinaryExpression*(*BitwiseORExpression*, |, *BitwiseXORExpression*).

### 13.13 Binary Logical Operators

#### Syntax

```

LogicalANDExpression[In, Yield, Await] :
    BitwiseORExpression[?In, ?Yield, ?Await]
    LogicalANDExpression[?In, ?Yield, ?Await] &&
    BitwiseORExpression[?In, ?Yield, ?Await]

```

```

LogicalORExpression[In, Yield, Await] :
    LogicalANDExpression[?In, ?Yield, ?Await]
    LogicalORExpression[?In, ?Yield, ?Await] ||
    LogicalANDExpression[?In, ?Yield, ?Await]

```

```

CoalesceExpression[In, Yield, Await] :
    CoalesceExpressionHead[?In, ?Yield, ?Await] ??
    BitwiseORExpression[?In, ?Yield, ?Await]

```

```

CoalesceExpressionHead[In, Yield, Await] :
    CoalesceExpression[?In, ?Yield, ?Await]
    BitwiseORExpression[?In, ?Yield, ?Await]

```

```

ShortCircuitExpression[In, Yield, Await] :
    LogicalORExpression[?In, ?Yield, ?Await]
    CoalesceExpression[?In, ?Yield, ?Await]

```

**NOTE** The value produced by a && or || operator is not necessarily of type Boolean. The value produced will always be the value of one of the two operand expressions.

#### 13.13.1 Runtime Semantics: Evaluation

*LogicalANDExpression* : *LogicalANDExpression* && *BitwiseORExpression*

1. Let *lref* be ? Evaluation of *LogicalANDExpression*.
2. Let *lval* be ? *GetValue(lref)*.
3. Let *lbool* be *ToBoolean(lval)*.
4. If *lbool* is **false**, return *lval*.
5. Let *rref* be ? Evaluation of *BitwiseORExpression*.
6. Return ? *GetValue(rref)*.

*LogicalORExpression* : *LogicalORExpression* | | *LogicalANDExpression*

1. Let *lref* be ? Evaluation of *LogicalORExpression*.
2. Let *lval* be ? *GetValue(lref)*.
3. Let *lbool* be *ToBoolean(lval)*.
4. If *lbool* is **true**, return *lval*.
5. Let *rref* be ? Evaluation of *LogicalANDExpression*.
6. Return ? *GetValue(rref)*.

*CoalesceExpression* : *CoalesceExpressionHead* ?? *BitwiseORExpression*

1. Let *lref* be ? Evaluation of *CoalesceExpressionHead*.
2. Let *lval* be ? *GetValue(lref)*.
3. If *lval* is either **undefined** or **null**, then
  - a. Let *rref* be ? Evaluation of *BitwiseORExpression*.
  - b. Return ? *GetValue(rref)*.
4. Otherwise, return *lval*.

## 13.14 Conditional Operator ( ? : )

### Syntax

```

ConditionalExpression[In, Yield, Await] :
  ShortCircuitExpression[?In, ?Yield, ?Await]
  ShortCircuitExpression[?In, ?Yield, ?Await] ?
    AssignmentExpression[+In, ?Yield, ?Await] :
    AssignmentExpression[?In, ?Yield, ?Await]

```

**NOTE** The grammar for a *ConditionalExpression* in ECMAScript is slightly different from that in C and Java, which each allow the second subexpression to be an *Expression* but restrict the third expression to be a *ConditionalExpression*. The motivation for this difference in ECMAScript is to allow an assignment expression to be governed by either arm of a conditional and to eliminate the confusing and fairly useless case of a comma expression as the centre expression.

### 13.14.1 Runtime Semantics: Evaluation

*ConditionalExpression* : *ShortCircuitExpression* ? *AssignmentExpression* : *AssignmentExpression*

1. Let *lref* be ? Evaluation of *ShortCircuitExpression*.
2. Let *lval* be *ToBoolean(? GetValue(lref))*.
3. If *lval* is **true**, then
  - a. Let *trueRef* be ? Evaluation of the first *AssignmentExpression*.
  - b. Return ? *GetValue(trueRef)*.

4. Else,
  - a. Let *falseRef* be ? [Evaluation](#) of the second *AssignmentExpression*.
  - b. Return ? [GetValue](#)(*falseRef*).

## 13.15 Assignment Operators

### Syntax

```

AssignmentExpression[In, Yield, Await] :
  ConditionalExpression[?In, ?Yield, ?Await]
  [+Yield] YieldExpression[?In, ?Await]
  ArrowFunction[?In, ?Yield, ?Await]
  AsyncArrowFunction[?In, ?Yield, ?Await]
  LeftHandSideExpression[?Yield, ?Await] =
    AssignmentExpression[?In, ?Yield, ?Await]
  LeftHandSideExpression[?Yield, ?Await] AssignmentOperator
    AssignmentExpression[?In, ?Yield, ?Await]
  LeftHandSideExpression[?Yield, ?Await] &&=
    AssignmentExpression[?In, ?Yield, ?Await]
  LeftHandSideExpression[?Yield, ?Await] ||=
    AssignmentExpression[?In, ?Yield, ?Await]
  LeftHandSideExpression[?Yield, ?Await] ??=
    AssignmentExpression[?In, ?Yield, ?Await]

```

AssignmentOperator : **one of**  
 \*= /= %= += -= <<= >>= >>>= &= ^= |= \*\*=

### 13.15.1 Static Semantics: Early Errors

*AssignmentExpression* : *LeftHandSideExpression* = *AssignmentExpression*

If *LeftHandSideExpression* is either an *ObjectLiteral* or an *ArrayLiteral*, the following Early Error rules are applied:

- *LeftHandSideExpression* **must cover** an *AssignmentPattern*.

If *LeftHandSideExpression* is neither an *ObjectLiteral* nor an *ArrayLiteral*, the following Early Error rule is applied:

- It is a Syntax Error if [AssignmentTargetType](#) of *LeftHandSideExpression* is not simple.

*AssignmentExpression* :

```

LeftHandSideExpression AssignmentOperator AssignmentExpression
LeftHandSideExpression &&= AssignmentExpression
LeftHandSideExpression ||= AssignmentExpression
LeftHandSideExpression ??= AssignmentExpression

```

- It is a Syntax Error if [AssignmentTargetType](#) of *LeftHandSideExpression* is not simple.

### 13.15.2 Runtime Semantics: Evaluation

*AssignmentExpression* : *LeftHandSideExpression* = *AssignmentExpression*

1. If *LeftHandSideExpression* is neither an *ObjectLiteral* nor an *ArrayLiteral*, then
  - a. Let *lref* be ? *Evaluation* of *LeftHandSideExpression*.
  - b. If *IsAnonymousFunctionDefinition*(*AssignmentExpression*) and *IsIdentifierRef* of *LeftHandSideExpression* are both **true**, then
    - i. Let *rval* be ? *NamedEvaluation* of *AssignmentExpression* with argument *lref*.  
[[ReferencedName]].
  - c. Else,
    - i. Let *rref* be ? *Evaluation* of *AssignmentExpression*.
    - ii. Let *rval* be ? *GetValue*(*rref*).
  - d. Perform ? *PutValue*(*lref*, *rval*).
  - e. Return *rval*.
2. Let *assignmentPattern* be the *AssignmentPattern* that is *covered* by *LeftHandSideExpression*.
3. Let *rref* be ? *Evaluation* of *AssignmentExpression*.
4. Let *rval* be ? *GetValue*(*rref*).
5. Perform ? *DestructuringAssignmentEvaluation* of *assignmentPattern* with argument *rval*.
6. Return *rval*.

*AssignmentExpression* : *LeftHandSideExpression* *AssignmentOperator* *AssignmentExpression*

1. Let *lref* be ? *Evaluation* of *LeftHandSideExpression*.
2. Let *lval* be ? *GetValue*(*lref*).
3. Let *rref* be ? *Evaluation* of *AssignmentExpression*.
4. Let *rval* be ? *GetValue*(*rref*).
5. Let *assignmentOpText* be the *source text matched by AssignmentOperator*.
6. Let *opText* be the sequence of Unicode code points associated with *assignmentOpText* in the following table:

<i>assignmentOpText</i>	<i>opText</i>
**=	**
*=	*
/=	/
%=	%
+=	+
-=	-
<<=	<<
>>=	>>
>>>=	>>>
&=	&
^=	^
=	

7. Let *r* be ? *ApplyStringOrNumericBinaryOperator*(*lval*, *opText*, *rval*).
8. Perform ? *PutValue*(*lref*, *r*).
9. Return *r*.

*AssignmentExpression* : *LeftHandSideExpression* **&&=** *AssignmentExpression*

1. Let *lref* be ? *Evaluation* of *LeftHandSideExpression*.
2. Let *lval* be ? *GetValue*(*lref*).
3. Let *lbool* be *ToBoolean*(*lval*).
4. If *lbool* is **false**, return *lval*.
5. If *IsAnonymousFunctionDefinition*(*AssignmentExpression*) is **true** and *IsIdentifierRef* of *LeftHandSideExpression* is **true**, then

- a. Let *rval* be ? [NamedEvaluation](#) of *AssignmentExpression* with argument *lref*.  
[[ReferencedName]].
6. Else,
  - a. Let *rref* be ? [Evaluation](#) of *AssignmentExpression*.
  - b. Let *rval* be ? [GetValue](#)(*rref*).
7. Perform ? [PutValue](#)(*lref*, *rval*).
8. Return *rval*.

*AssignmentExpression* : *LeftHandSideExpression* | |= *AssignmentExpression*

1. Let *lref* be ? [Evaluation](#) of *LeftHandSideExpression*.
2. Let *lval* be ? [GetValue](#)(*lref*).
3. Let *lbool* be [ToBoolean](#)(*lval*).
4. If *lbool* is **true**, return *lval*.
5. If [IsAnonymousFunctionDefinition](#)(*AssignmentExpression*) is **true** and [IsIdentifierRef](#) of *LeftHandSideExpression* is **true**, then
  - a. Let *rval* be ? [NamedEvaluation](#) of *AssignmentExpression* with argument *lref*.  
[[ReferencedName]].
6. Else,
  - a. Let *rref* be ? [Evaluation](#) of *AssignmentExpression*.
  - b. Let *rval* be ? [GetValue](#)(*rref*).
7. Perform ? [PutValue](#)(*lref*, *rval*).
8. Return *rval*.

*AssignmentExpression* : *LeftHandSideExpression* ??= *AssignmentExpression*

1. Let *lref* be ? [Evaluation](#) of *LeftHandSideExpression*.
2. Let *lval* be ? [GetValue](#)(*lref*).
3. If *lval* is neither **undefined** nor **null**, return *lval*.
4. If [IsAnonymousFunctionDefinition](#)(*AssignmentExpression*) is **true** and [IsIdentifierRef](#) of *LeftHandSideExpression* is **true**, then
  - a. Let *rval* be ? [NamedEvaluation](#) of *AssignmentExpression* with argument *lref*.  
[[ReferencedName]].
5. Else,
  - a. Let *rref* be ? [Evaluation](#) of *AssignmentExpression*.
  - b. Let *rval* be ? [GetValue](#)(*rref*).
6. Perform ? [PutValue](#)(*lref*, *rval*).
7. Return *rval*.

**NOTE** When this expression occurs within [strict mode code](#), it is a runtime error if *lref* in step 1.d, 2, 2, 2, 2 is an unresolvable reference. If it is, a **ReferenceError** exception is thrown. Additionally, it is a runtime error if the *lref* in step 8, 7, 7, 6 is a reference to a [data property](#) with the attribute value { [\[\[Writable\]\]](#): **false** }, to an [accessor property](#) with the attribute value { [\[\[Set\]\]](#): **undefined** }, or to a non-existent property of an object for which the [IsExtensible](#) predicate returns the value **false**. In these cases a **TypeError** exception is thrown.

### 13.15.3 ApplyStringOrNumericBinaryOperator ( *lval*, *opText*, *rval* )

The abstract operation [ApplyStringOrNumericBinaryOperator](#) takes arguments *lval* (an [ECMAScript language value](#)), *opText* (**\*\***, **\***, **/**, **%**, **+**, **-**, **<<**, **>>**, **>>>**, **&**, **^**, or **|**), and *rval* (an [ECMAScript language value](#)) and returns either a [normal completion containing](#) either a [String](#), a [BigInt](#), or a [Number](#), or a [throw completion](#). It performs the following steps when called:

1. If *opText* is `+`, then
  - a. Let *lprim* be ? `ToPrimitive(lval)`.
  - b. Let *rprim* be ? `ToPrimitive(rval)`.
  - c. If *lprim* is a String or *rprim* is a String, then
    - i. Let *lstr* be ? `Tostring(lprim)`.
    - ii. Let *rstr* be ? `Tostring(rprim)`.
    - iii. Return the string-concatenation of *lstr* and *rstr*.
  - d. Set *lval* to *lprim*.
  - e. Set *rval* to *rprim*.
2. NOTE: At this point, it must be a numeric operation.
3. Let *lnum* be ? `ToNumeric(lval)`.
4. Let *rnum* be ? `ToNumeric(rval)`.
5. If `Type(lnum)` is not `Type(rnum)`, throw a **TypeError** exception.
6. If *lnum* is a `BigInt`, then
  - a. If *opText* is `**`, return ? `BigInt::exponentiate(lnum, rnum)`.
  - b. If *opText* is `/`, return ? `BigInt::divide(lnum, rnum)`.
  - c. If *opText* is `%`, return ? `BigInt::remainder(lnum, rnum)`.
  - d. If *opText* is `>>>`, return ? `BigInt::unsignedRightShift(lnum, rnum)`.
7. Let *operation* be the abstract operation associated with *opText* and `Type(lnum)` in the following table:

<i>opText</i>	<code>Type(lnum)</code>	<i>operation</i>
<code>**</code>	Number	<code>Number::exponentiate</code>
<code>*</code>	Number	<code>Number::multiply</code>
<code>*</code>	BigInt	<code>BigInt::multiply</code>
<code>/</code>	Number	<code>Number::divide</code>
<code>%</code>	Number	<code>Number::remainder</code>
<code>+</code>	Number	<code>Number::add</code>
<code>+</code>	BigInt	<code>BigInt::add</code>
<code>-</code>	Number	<code>Number::subtract</code>
<code>-</code>	BigInt	<code>BigInt::subtract</code>
<code>&lt;&lt;</code>	Number	<code>Number::leftShift</code>
<code>&lt;&lt;</code>	BigInt	<code>BigInt::leftShift</code>
<code>&gt;&gt;</code>	Number	<code>Number::signedRightShift</code>
<code>&gt;&gt;</code>	BigInt	<code>BigInt::signedRightShift</code>
<code>&gt;&gt;&gt;</code>	Number	<code>Number::unsignedRightShift</code>
<code>&amp;</code>	Number	<code>Number::bitwiseAND</code>
<code>&amp;</code>	BigInt	<code>BigInt::bitwiseAND</code>
<code>^</code>	Number	<code>Number::bitwiseXOR</code>
<code>^</code>	BigInt	<code>BigInt::bitwiseXOR</code>
<code> </code>	Number	<code>Number::bitwiseOR</code>
<code> </code>	BigInt	<code>BigInt::bitwiseOR</code>

8. Return *operation*(*lnum*, *rnum*).

NOTE 1 No hint is provided in the calls to `ToPrimitive` in steps 1.a and 1.b. All standard objects except Dates handle the absence of a hint as if number were given; Dates handle the absence of a hint as if string were given. Exotic objects may handle the absence of a hint in some other manner.

NOTE 2 Step 1.c differs from step 3 of the `IsLessThan` algorithm, by using the logical-or operation instead of the logical-and operation.

### 13.15.4 EvaluateStringOrNumericBinaryExpression ( *leftOperand*, *opText*, *rightOperand* )

The abstract operation `EvaluateStringOrNumericBinaryExpression` takes arguments *leftOperand* (a `Parse Node`), *opText* (a sequence of Unicode code points), and *rightOperand* (a `Parse Node`) and returns either a `normal completion containing` either a `String`, a `BigInt`, or a `Number`, or an `abrupt completion`. It performs the following steps when called:

1. Let *lref* be ? `Evaluation` of *leftOperand*.
2. Let *lval* be ? `GetValue`(*lref*).
3. Let *rref* be ? `Evaluation` of *rightOperand*.
4. Let *rval* be ? `GetValue`(*rref*).
5. Return ? `ApplyStringOrNumericBinaryOperator`(*lval*, *opText*, *rval*).

### 13.15.5 Destructuring Assignment

#### Supplemental Syntax

In certain circumstances when processing an instance of the production `AssignmentExpression : LeftHandSideExpression = AssignmentExpression` the interpretation of `LeftHandSideExpression` is refined using the following grammar:

```

AssignmentPattern[Yield, Await] :
    ObjectAssignmentPattern[?Yield, ?Await]
    ArrayAssignmentPattern[?Yield, ?Await]

ObjectAssignmentPattern[Yield, Await] :
    { }
    { AssignmentRestProperty[?Yield, ?Await] }
    { AssignmentPropertyList[?Yield, ?Await] }
    { AssignmentPropertyList[?Yield, ?Await] ,
      AssignmentRestProperty[?Yield, ?Await] opt }

ArrayAssignmentPattern[Yield, Await] :
    [ Elisionopt AssignmentRestElement[?Yield, ?Await] opt ]
    [ AssignmentElementList[?Yield, ?Await] ]
    [ AssignmentElementList[?Yield, ?Await] , Elisionopt
      AssignmentRestElement[?Yield, ?Await] opt ]

AssignmentRestProperty[Yield, Await] :
    ... DestructuringAssignmentTarget[?Yield, ?Await]

AssignmentPropertyList[Yield, Await] :
    AssignmentProperty[?Yield, ?Await]
    AssignmentPropertyList[?Yield, ?Await] , AssignmentProperty[?Yield, ?Await]

AssignmentElementList[Yield, Await] :

```



```

AssignmentElisionElement[?Yield, ?Await]
AssignmentElementList[?Yield, ?Await] , AssignmentElisionElement[?Yield, ?Await]

AssignmentElisionElement[Yield, Await] :
  Elisionopt AssignmentElement[?Yield, ?Await]

AssignmentProperty[Yield, Await] :
  IdentifierReference[?Yield, ?Await] Initializer[+In, ?Yield, ?Await] opt
  PropertyName[?Yield, ?Await] : AssignmentElement[?Yield, ?Await]

AssignmentElement[Yield, Await] :
  DestructuringAssignmentTarget[?Yield, ?Await] Initializer[+In, ?Yield, ?Await] opt

AssignmentRestElement[Yield, Await] :
  ... DestructuringAssignmentTarget[?Yield, ?Await]

DestructuringAssignmentTarget[Yield, Await] :
  LeftHandSideExpression[?Yield, ?Await]

```

### 13.15.5.1 Static Semantics: Early Errors

*AssignmentProperty* : *IdentifierReference* *Initializer*<sub>opt</sub>

- It is a Syntax Error if *AssignmentTargetType* of *IdentifierReference* is not simple.

*AssignmentRestProperty* : ... *DestructuringAssignmentTarget*

- It is a Syntax Error if *DestructuringAssignmentTarget* is either an *ArrayLiteral* or an *ObjectLiteral*.

*DestructuringAssignmentTarget* : *LeftHandSideExpression*

If *LeftHandSideExpression* is either an *ObjectLiteral* or an *ArrayLiteral*, the following Early Error rules are applied:

- *LeftHandSideExpression* **must cover** an *AssignmentPattern*.

If *LeftHandSideExpression* is neither an *ObjectLiteral* nor an *ArrayLiteral*, the following Early Error rule is applied:

- It is a Syntax Error if *AssignmentTargetType* of *LeftHandSideExpression* is not simple.

### 13.15.5.2 Runtime Semantics: DestructuringAssignmentEvaluation

The **syntax-directed operation** *DestructuringAssignmentEvaluation* takes argument *value* (an *ECMAScript language value*) and returns either a **normal completion containing** unused or an **abrupt completion**. It is defined piecewise over the following productions:

*ObjectAssignmentPattern* : { }

1. Perform ? **RequireObjectCoercible**(*value*).
2. Return unused.

*ObjectAssignmentPattern* :  
 { *AssignmentPropertyList* }  
 { *AssignmentPropertyList* , }

1. Perform ? [RequireObjectCoercible](#)(*value*).
2. Perform ? [PropertyDestructuringAssignmentEvaluation](#) of *AssignmentPropertyList* with argument *value*.
3. Return unused.

*ObjectAssignmentPattern* : { *AssignmentRestProperty* }

1. Perform ? [RequireObjectCoercible](#)(*value*).
2. Let *excludedNames* be a new empty *List*.
3. Return ? [RestDestructuringAssignmentEvaluation](#) of *AssignmentRestProperty* with arguments *value* and *excludedNames*.

*ObjectAssignmentPattern* : { *AssignmentPropertyList* , *AssignmentRestProperty* }

1. Perform ? [RequireObjectCoercible](#)(*value*).
2. Let *excludedNames* be ? [PropertyDestructuringAssignmentEvaluation](#) of *AssignmentPropertyList* with argument *value*.
3. Return ? [RestDestructuringAssignmentEvaluation](#) of *AssignmentRestProperty* with arguments *value* and *excludedNames*.

*ArrayAssignmentPattern* : [ ]

1. Let *iteratorRecord* be ? [GetIterator](#)(*value*, sync).
2. Return ? [IteratorClose](#)(*iteratorRecord*, [NormalCompletion](#)(unused)).

*ArrayAssignmentPattern* : [ *Elision* ]

1. Let *iteratorRecord* be ? [GetIterator](#)(*value*, sync).
2. Let *result* be [Completion](#)([IteratorDestructuringAssignmentEvaluation](#) of *Elision* with argument *iteratorRecord*).
3. If *iteratorRecord*.[[Done]] is **false**, return ? [IteratorClose](#)(*iteratorRecord*, *result*).
4. Return *result*.

*ArrayAssignmentPattern* : [ *Elision*<sub>opt</sub> *AssignmentRestElement* ]

1. Let *iteratorRecord* be ? [GetIterator](#)(*value*, sync).
2. If *Elision* is present, then
  - a. Let *status* be [Completion](#)([IteratorDestructuringAssignmentEvaluation](#) of *Elision* with argument *iteratorRecord*).
  - b. If *status* is an abrupt completion, then
    - i. **Assert**: *iteratorRecord*.[[Done]] is **true**.
    - ii. Return ? *status*.
3. Let *result* be [Completion](#)([IteratorDestructuringAssignmentEvaluation](#) of *AssignmentRestElement* with argument *iteratorRecord*).
4. If *iteratorRecord*.[[Done]] is **false**, return ? [IteratorClose](#)(*iteratorRecord*, *result*).
5. Return *result*.

*ArrayAssignmentPattern* : [ *AssignmentElementList* ]

1. Let *iteratorRecord* be ? [GetIterator](#)(*value*, sync).
2. Let *result* be [Completion](#)([IteratorDestructuringAssignmentEvaluation](#) of *AssignmentElementList* with argument *iteratorRecord*).
3. If *iteratorRecord*.[[Done]] is **false**, return ? [IteratorClose](#)(*iteratorRecord*, *result*).
4. Return *result*.

*ArrayAssignmentPattern* : [ *AssignmentElementList* , *Elision*<sub>opt</sub> *AssignmentRestElement*<sub>opt</sub> ]

1. Let *iteratorRecord* be ? *GetIterator*(*value*, sync).
2. Let *status* be *Completion*(*IteratorDestructuringAssignmentEvaluation* of *AssignmentElementList* with argument *iteratorRecord*).
3. If *status* is an abrupt completion, then
  - a. If *iteratorRecord*.[[Done]] is **false**, return ? *IteratorClose*(*iteratorRecord*, *status*).
  - b. Return ? *status*.
4. If *Elision* is present, then
  - a. Set *status* to *Completion*(*IteratorDestructuringAssignmentEvaluation* of *Elision* with argument *iteratorRecord*).
  - b. If *status* is an abrupt completion, then
    - i. **Assert**: *iteratorRecord*.[[Done]] is **true**.
    - ii. Return ? *status*.
5. If *AssignmentRestElement* is present, then
  - a. Set *status* to *Completion*(*IteratorDestructuringAssignmentEvaluation* of *AssignmentRestElement* with argument *iteratorRecord*).
6. If *iteratorRecord*.[[Done]] is **false**, return ? *IteratorClose*(*iteratorRecord*, *status*).
7. Return ? *status*.

### 13.15.5.3 Runtime Semantics: PropertyDestructuringAssignmentEvaluation

The *syntax-directed operation* *PropertyDestructuringAssignmentEvaluation* takes argument *value* (an ECMAScript language value) and returns either a *normal completion containing* a List of *property keys* or an *abrupt completion*. It collects a list of all destructured *property keys*. It is defined piecewise over the following productions:

*AssignmentPropertyList* : *AssignmentPropertyList* , *AssignmentProperty*

1. Let *propertyNames* be ? *PropertyDestructuringAssignmentEvaluation* of *AssignmentPropertyList* with argument *value*.
2. Let *nextNames* be ? *PropertyDestructuringAssignmentEvaluation* of *AssignmentProperty* with argument *value*.
3. Return the *list-concatenation* of *propertyNames* and *nextNames*.

*AssignmentProperty* : *IdentifierReference* *Initializer*<sub>opt</sub>

1. Let *P* be *StringValue* of *IdentifierReference*.
2. Let *Iref* be ? *ResolveBinding*(*P*).
3. Let *v* be ? *GetV*(*value*, *P*).
4. If *Initializer*<sub>opt</sub> is present and *v* is **undefined**, then
  - a. If *IsAnonymousFunctionDefinition*(*Initializer*) is **true**, then
    - i. Set *v* to ? *NamedEvaluation* of *Initializer* with argument *P*.
  - b. Else,
    - i. Let *defaultValue* be ? *Evaluation* of *Initializer*.
    - ii. Set *v* to ? *GetValue*(*defaultValue*).
5. Perform ? *PutValue*(*Iref*, *v*).
6. Return « *P* ».

*AssignmentProperty* : *PropertyName* : *AssignmentElement*

1. Let *name* be ? [Evaluation of \*PropertyName\*](#).
2. Perform ? [KeyedDestructuringAssignmentEvaluation](#) of *AssignmentElement* with arguments *value* and *name*.
3. Return « *name* ».

#### 13.15.5.4 Runtime Semantics: RestDestructuringAssignmentEvaluation

The [syntax-directed operation](#) `RestDestructuringAssignmentEvaluation` takes arguments *value* (an ECMAScript language value) and *excludedNames* (a List of [property keys](#)) and returns either a [normal completion containing unused](#) or an [abrupt completion](#). It is defined piecewise over the following productions:

*AssignmentRestProperty* : . . . *DestructuringAssignmentTarget*

1. Let *lref* be ? [Evaluation of \*DestructuringAssignmentTarget\*](#).
2. Let *restObj* be [OrdinaryObjectCreate\(%Object.prototype%\)](#).
3. Perform ? [CopyDataProperties\(\*restObj\*, \*value\*, \*excludedNames\*\)](#).
4. Return ? [PutValue\(\*lref\*, \*restObj\*\)](#).

#### 13.15.5.5 Runtime Semantics: IteratorDestructuringAssignmentEvaluation

The [syntax-directed operation](#) `IteratorDestructuringAssignmentEvaluation` takes argument *iteratorRecord* (an [Iterator Record](#)) and returns either a [normal completion containing unused](#) or an [abrupt completion](#). It is defined piecewise over the following productions:

*AssignmentElementList* : *AssignmentElisionElement*

1. Return ? [IteratorDestructuringAssignmentEvaluation](#) of *AssignmentElisionElement* with argument *iteratorRecord*.

*AssignmentElementList* : *AssignmentElementList* , *AssignmentElisionElement*

1. Perform ? [IteratorDestructuringAssignmentEvaluation](#) of *AssignmentElementList* with argument *iteratorRecord*.
2. Return ? [IteratorDestructuringAssignmentEvaluation](#) of *AssignmentElisionElement* with argument *iteratorRecord*.

*AssignmentElisionElement* : *AssignmentElement*

1. Return ? [IteratorDestructuringAssignmentEvaluation](#) of *AssignmentElement* with argument *iteratorRecord*.

*AssignmentElisionElement* : *Elision* *AssignmentElement*

1. Perform ? [IteratorDestructuringAssignmentEvaluation](#) of *Elision* with argument *iteratorRecord*.
2. Return ? [IteratorDestructuringAssignmentEvaluation](#) of *AssignmentElement* with argument *iteratorRecord*.

*Elision* : ,

1. If *iteratorRecord*.[[Done]] is **false**, then
  - a. Let *next* be [Completion\(IteratorStep\(\*iteratorRecord\*\)\)](#).
  - b. If *next* is an [abrupt completion](#), set *iteratorRecord*.[[Done]] to **true**.
  - c. [ReturnIfAbrupt\(\*next\*\)](#).
  - d. If *next* is **false**, set *iteratorRecord*.[[Done]] to **true**.
2. Return unused.

*Elision* : *Elision* ,

1. Perform ? *IteratorDestructuringAssignmentEvaluation* of *Elision* with argument *iteratorRecord*.
2. If *iteratorRecord*.[[Done]] is **false**, then
  - a. Let *next* be *Completion*(*IteratorStep*(*iteratorRecord*)).
  - b. If *next* is an abrupt completion, set *iteratorRecord*.[[Done]] to **true**.
  - c. *ReturnIfAbrupt*(*next*).
  - d. If *next* is **false**, set *iteratorRecord*.[[Done]] to **true**.
3. Return unused.

*AssignmentElement* : *DestructuringAssignmentTarget* *Initializer*<sub>opt</sub>

1. If *DestructuringAssignmentTarget* is neither an *ObjectLiteral* nor an *ArrayLiteral*, then
  - a. Let *lref* be ? *Evaluation* of *DestructuringAssignmentTarget*.
2. If *iteratorRecord*.[[Done]] is **false**, then
  - a. Let *next* be *Completion*(*IteratorStep*(*iteratorRecord*)).
  - b. If *next* is an abrupt completion, set *iteratorRecord*.[[Done]] to **true**.
  - c. *ReturnIfAbrupt*(*next*).
  - d. If *next* is **false**, set *iteratorRecord*.[[Done]] to **true**.
  - e. Else,
    - i. Let *value* be *Completion*(*IteratorValue*(*next*)).
    - ii. If *value* is an abrupt completion, set *iteratorRecord*.[[Done]] to **true**.
    - iii. *ReturnIfAbrupt*(*value*).
3. If *iteratorRecord*.[[Done]] is **true**, let *value* be **undefined**.
4. If *Initializer* is present and *value* is **undefined**, then
  - a. If *IsAnonymousFunctionDefinition*(*Initializer*) is **true** and *IsIdentifierRef* of *DestructuringAssignmentTarget* is **true**, then
    - i. Let *v* be ? *NamedEvaluation* of *Initializer* with argument *lref*.[[ReferencedName]].
  - b. Else,
    - i. Let *defaultValue* be ? *Evaluation* of *Initializer*.
    - ii. Let *v* be ? *GetValue*(*defaultValue*).
5. Else, let *v* be *value*.
6. If *DestructuringAssignmentTarget* is either an *ObjectLiteral* or an *ArrayLiteral*, then
  - a. Let *nestedAssignmentPattern* be the *AssignmentPattern* that is *covered* by *DestructuringAssignmentTarget*.
  - b. Return ? *DestructuringAssignmentEvaluation* of *nestedAssignmentPattern* with argument *v*.
7. Return ? *PutValue*(*lref*, *v*).

**NOTE** Left to right evaluation order is maintained by evaluating a *DestructuringAssignmentTarget* that is not a destructuring pattern prior to accessing the iterator or evaluating the *Initializer*.

*AssignmentRestElement* : . . . *DestructuringAssignmentTarget*

1. If *DestructuringAssignmentTarget* is neither an *ObjectLiteral* nor an *ArrayLiteral*, then
  - a. Let *lref* be ? *Evaluation* of *DestructuringAssignmentTarget*.
2. Let *A* be ! *ArrayCreate*(0).
3. Let *n* be 0.
4. Repeat, while *iteratorRecord*.[[Done]] is **false**,
  - a. Let *next* be *Completion*(*IteratorStep*(*iteratorRecord*)).
  - b. If *next* is an abrupt completion, set *iteratorRecord*.[[Done]] to **true**.
  - c. *ReturnIfAbrupt*(*next*).
  - d. If *next* is **false**, set *iteratorRecord*.[[Done]] to **true**.
  - e. Else,

- i. Let *nextValue* be `Completion(IteratorValue(next))`.
  - ii. If *nextValue* is an abrupt completion, set *iteratorRecord*.[[Done]] to **true**.
  - iii. `ReturnIfAbrupt(nextValue)`.
  - iv. Perform ! `CreateDataPropertyOrThrow(A, ! ToString(F(n)), nextValue)`.
  - v. Set *n* to *n* + 1.
5. If *DestructuringAssignmentTarget* is neither an *ObjectLiteral* nor an *ArrayLiteral*, then
    - a. Return ? `PutValue(lref, A)`.
  6. Let *nestedAssignmentPattern* be the *AssignmentPattern* that is covered by *DestructuringAssignmentTarget*.
  7. Return ? `DestructuringAssignmentEvaluation` of *nestedAssignmentPattern* with argument *A*.

### 13.15.5.6 Runtime Semantics: KeyedDestructuringAssignmentEvaluation

The `syntax-directed operation` `KeyedDestructuringAssignmentEvaluation` takes arguments *value* (an ECMAScript language value) and *propertyName* (a property key) and returns either a normal completion containing unused or an abrupt completion. It is defined piecewise over the following productions:

*AssignmentElement* : *DestructuringAssignmentTarget* *Initializer*<sub>opt</sub>

1. If *DestructuringAssignmentTarget* is neither an *ObjectLiteral* nor an *ArrayLiteral*, then
  - a. Let *lref* be ? `Evaluation` of *DestructuringAssignmentTarget*.
2. Let *v* be ? `GetV(value, propertyName)`.
3. If *Initializer* is present and *v* is **undefined**, then
  - a. If `IsAnonymousFunctionDefinition(Initializer)` and `IsIdentifierRef` of *DestructuringAssignmentTarget* are both **true**, then
    - i. Let *rhsValue* be ? `NamedEvaluation` of *Initializer* with argument *lref*.[[ReferencedName]].
  - b. Else,
    - i. Let *defaultValue* be ? `Evaluation` of *Initializer*.
    - ii. Let *rhsValue* be ? `GetValue(defaultValue)`.
4. Else, let *rhsValue* be *v*.
5. If *DestructuringAssignmentTarget* is either an *ObjectLiteral* or an *ArrayLiteral*, then
  - a. Let *assignmentPattern* be the *AssignmentPattern* that is covered by *DestructuringAssignmentTarget*.
  - b. Return ? `DestructuringAssignmentEvaluation` of *assignmentPattern* with argument *rhsValue*.
6. Return ? `PutValue(lref, rhsValue)`.

## 13.16 Comma Operator ( , )

### Syntax

*Expression*<sub>[In, Yield, Await]</sub> :  
*AssignmentExpression*<sub>[?In, ?Yield, ?Await]</sub>  
*Expression*<sub>[?In, ?Yield, ?Await]</sub> , *AssignmentExpression*<sub>[?In, ?Yield, ?Await]</sub>

### 13.16.1 Runtime Semantics: Evaluation

*Expression* : *Expression* , *AssignmentExpression*

1. Let *lref* be ? `Evaluation` of *Expression*.
2. Perform ? `GetValue(lref)`.
3. Let *rref* be ? `Evaluation` of *AssignmentExpression*.
4. Return ? `GetValue(rref)`.

**NOTE** `GetValue` must be called even though its value is not used because it may have observable side-effects.

## 14 ECMAScript Language: Statements and Declarations

### Syntax

*Statement*<sub>[Yield, Await, Return]</sub> :

- BlockStatement*<sub>[?Yield, ?Await, ?Return]</sub>
- VariableStatement*<sub>[?Yield, ?Await]</sub>
- EmptyStatement*
- ExpressionStatement*<sub>[?Yield, ?Await]</sub>
- IfStatement*<sub>[?Yield, ?Await, ?Return]</sub>
- BreakableStatement*<sub>[?Yield, ?Await, ?Return]</sub>
- ContinueStatement*<sub>[?Yield, ?Await]</sub>
- BreakStatement*<sub>[?Yield, ?Await]</sub>
- [+Return] ReturnStatement*<sub>[?Yield, ?Await]</sub>
- WithStatement*<sub>[?Yield, ?Await, ?Return]</sub>
- LabelledStatement*<sub>[?Yield, ?Await, ?Return]</sub>
- ThrowStatement*<sub>[?Yield, ?Await]</sub>
- TryStatement*<sub>[?Yield, ?Await, ?Return]</sub>
- DebuggerStatement*

*Declaration*<sub>[Yield, Await]</sub> :

- HoistableDeclaration*<sub>[?Yield, ?Await, ~Default]</sub>
- ClassDeclaration*<sub>[?Yield, ?Await, ~Default]</sub>
- LexicalDeclaration*<sub>[+In, ?Yield, ?Await]</sub>

*HoistableDeclaration*<sub>[Yield, Await, Default]</sub> :

- FunctionDeclaration*<sub>[?Yield, ?Await, ?Default]</sub>
- GeneratorDeclaration*<sub>[?Yield, ?Await, ?Default]</sub>
- AsyncFunctionDeclaration*<sub>[?Yield, ?Await, ?Default]</sub>
- AsyncGeneratorDeclaration*<sub>[?Yield, ?Await, ?Default]</sub>

*BreakableStatement*<sub>[Yield, Await, Return]</sub> :

- IterationStatement*<sub>[?Yield, ?Await, ?Return]</sub>
- SwitchStatement*<sub>[?Yield, ?Await, ?Return]</sub>

### 14.1 Statement Semantics

#### 14.1.1 Runtime Semantics: Evaluation

*HoistableDeclaration* :

- GeneratorDeclaration*
- AsyncFunctionDeclaration*
- AsyncGeneratorDeclaration*

1. Return empty.

*HoistableDeclaration* : *FunctionDeclaration*

1. Return ? [Evaluation](#) of *FunctionDeclaration*.

*BreakableStatement* :

*IterationStatement*

*SwitchStatement*

1. Let *newLabelSet* be a new empty [List](#).
2. Return ? [LabelledEvaluation](#) of this *BreakableStatement* with argument *newLabelSet*.

## 14.2 Block

### Syntax

*BlockStatement*<sub>[Yield, Await, Return]</sub> :  
*Block*<sub>[?Yield, ?Await, ?Return]</sub>

*Block*<sub>[Yield, Await, Return]</sub> :  
 { *StatementList*<sub>[?Yield, ?Await, ?Return]</sub> *opt* }

*StatementList*<sub>[Yield, Await, Return]</sub> :  
*StatementListItem*<sub>[?Yield, ?Await, ?Return]</sub>  
*StatementList*<sub>[?Yield, ?Await, ?Return]</sub> *StatementListItem*<sub>[?Yield, ?Await, ?Return]</sub>

*StatementListItem*<sub>[Yield, Await, Return]</sub> :  
*Statement*<sub>[?Yield, ?Await, ?Return]</sub>  
*Declaration*<sub>[?Yield, ?Await]</sub>

### 14.2.1 Static Semantics: Early Errors

*Block* : { *StatementList* }

- It is a Syntax Error if the [LexicallyDeclaredNames](#) of *StatementList* contains any duplicate entries.
- It is a Syntax Error if any element of the [LexicallyDeclaredNames](#) of *StatementList* also occurs in the [VarDeclaredNames](#) of *StatementList*.

### 14.2.2 Runtime Semantics: Evaluation

*Block* : { }

1. Return empty.

*Block* : { *StatementList* }

1. Let *oldEnv* be the [running execution context](#)'s [LexicalEnvironment](#).
2. Let *blockEnv* be [NewDeclarativeEnvironment](#)(*oldEnv*).
3. Perform [BlockDeclarationInstantiation](#)(*StatementList*, *blockEnv*).
4. Set the [running execution context](#)'s [LexicalEnvironment](#) to *blockEnv*.
5. Let *blockValue* be [Completion](#)([Evaluation](#) of *StatementList*).
6. Set the [running execution context](#)'s [LexicalEnvironment](#) to *oldEnv*.
7. Return ? *blockValue*.



NOTE 1 No matter how control leaves the *Block* the *LexicalEnvironment* is always restored to its former state.

*StatementList* : *StatementList* *StatementListItem*

1. Let *s* be ? *Evaluation* of *StatementList*.
2. Let *s* be *Completion*(*Evaluation* of *StatementListItem*).
3. Return ? *UpdateEmpty*(*s*, *s*).

NOTE 2 The value of a *StatementList* is the value of the last value-producing item in the *StatementList*. For example, the following calls to the **eval** function all return the value 1:

```
eval("1;;;;;")
eval("1;{}")
eval("1;var a;")
```

### 14.2.3 BlockDeclarationInstantiation ( *code*, *env* )

The abstract operation *BlockDeclarationInstantiation* takes arguments *code* (a *Parse Node*) and *env* (a *Declarative Environment Record*) and returns unused. *code* is the *Parse Node* corresponding to the body of the block. *env* is the *Environment Record* in which bindings are to be created.

NOTE When a *Block* or *CaseBlock* is evaluated a new *Declarative Environment Record* is created and bindings for each block scoped variable, constant, function, or class declared in the block are instantiated in the *Environment Record*.

It performs the following steps when called:

1. Let *declarations* be the *LexicallyScopedDeclarations* of *code*.
2. Let *privateEnv* be the *running execution context*'s *PrivateEnvironment*.
3. For each element *d* of *declarations*, do
  - a. For each element *dn* of the *BoundNames* of *d*, do
    - i. If *IsConstantDeclaration* of *d* is **true**, then
      1. Perform ! *env*.*CreateImmutableBinding*(*dn*, **true**).
    - ii. Else,
      1. Perform ! *env*.*CreateMutableBinding*(*dn*, **false**). NOTE: This step is replaced in section B.3.2.6.
  - b. If *d* is either a *FunctionDeclaration*, a *GeneratorDeclaration*, an *AsyncFunctionDeclaration*, or an *AsyncGeneratorDeclaration*, then
    - i. Let *fn* be the sole element of the *BoundNames* of *d*.
    - ii. Let *fo* be *InstantiateFunctionObject* of *d* with arguments *env* and *privateEnv*.
    - iii. Perform ! *env*.*InitializeBinding*(*fn*, *fo*). NOTE: This step is replaced in section B.3.2.6.
4. Return unused.

## 14.3 Declarations and the Variable Statement

### 14.3.1 Let and Const Declarations

**NOTE** **let** and **const** declarations define variables that are scoped to the [running execution context](#)'s [LexicalEnvironment](#). The variables are created when their containing [Environment Record](#) is instantiated but may not be accessed in any way until the variable's [LexicalBinding](#) is evaluated. A variable defined by a [LexicalBinding](#) with an [Initializer](#) is assigned the value of its [Initializer's AssignmentExpression](#) when the [LexicalBinding](#) is evaluated, not when the variable is created. If a [LexicalBinding](#) in a **let** declaration does not have an [Initializer](#) the variable is assigned the value **undefined** when the [LexicalBinding](#) is evaluated.

#### Syntax

```

LexicalDeclaration[In, Yield, Await] :
    LetOrConst BindingList[?In, ?Yield, ?Await] ;

LetOrConst :
    let
    const

BindingList[In, Yield, Await] :
    LexicalBinding[?In, ?Yield, ?Await]
    BindingList[?In, ?Yield, ?Await] , LexicalBinding[?In, ?Yield, ?Await]

LexicalBinding[In, Yield, Await] :
    BindingIdentifier[?Yield, ?Await] Initializer[?In, ?Yield, ?Await] opt
    BindingPattern[?Yield, ?Await] Initializer[?In, ?Yield, ?Await]

```

#### 14.3.1.1 Static Semantics: Early Errors

*LexicalDeclaration* : *LetOrConst BindingList* ;

- It is a Syntax Error if the [BoundNames](#) of *BindingList* contains **"let"**.
- It is a Syntax Error if the [BoundNames](#) of *BindingList* contains any duplicate entries.

*LexicalBinding* : *BindingIdentifier Initializer*<sub>opt</sub>

- It is a Syntax Error if *Initializer* is not present and [IsConstantDeclaration](#) of the *LexicalDeclaration* containing this *LexicalBinding* is **true**.

#### 14.3.1.2 Runtime Semantics: Evaluation

*LexicalDeclaration* : *LetOrConst BindingList* ;

1. Perform ? [Evaluation](#) of *BindingList*.
2. Return empty.

*BindingList* : *BindingList* , *LexicalBinding*

1. Perform ? [Evaluation](#) of *BindingList*.
2. Return ? [Evaluation](#) of *LexicalBinding*.

*LexicalBinding* : *BindingIdentifier*

1. Let *lhs* be ! [ResolveBinding\(StringValue of BindingIdentifier\)](#).
2. Perform ! [InitializeReferencedBinding\(lhs, undefined\)](#).
3. Return empty.

**NOTE** A [static semantics](#) rule ensures that this form of *LexicalBinding* never occurs in a **const** declaration.

*LexicalBinding* : *BindingIdentifier Initializer*

1. Let *bindingId* be [StringValue](#) of *BindingIdentifier*.
2. Let *lhs* be ! [ResolveBinding\(bindingId\)](#).
3. If [IsAnonymousFunctionDefinition\(Initializer\)](#) is **true**, then
  - a. Let *value* be ? [NamedEvaluation](#) of *Initializer* with argument *bindingId*.
4. Else,
  - a. Let *rhs* be ? [Evaluation](#) of *Initializer*.
  - b. Let *value* be ? [GetValue\(rhs\)](#).
5. Perform ! [InitializeReferencedBinding\(lhs, value\)](#).
6. Return empty.

*LexicalBinding* : *BindingPattern Initializer*

1. Let *rhs* be ? [Evaluation](#) of *Initializer*.
2. Let *value* be ? [GetValue\(rhs\)](#).
3. Let *env* be the [running execution context](#)'s [LexicalEnvironment](#).
4. Return ? [BindingInitialization](#) of *BindingPattern* with arguments *value* and *env*.

### 14.3.2 Variable Statement

**NOTE** A **var** statement declares variables that are scoped to the [running execution context](#)'s [VariableEnvironment](#). Var variables are created when their containing [Environment Record](#) is instantiated and are initialized to **undefined** when created. Within the scope of any [VariableEnvironment](#) a common *BindingIdentifier* may appear in more than one *VariableDeclaration* but those declarations collectively define only one variable. A variable defined by a *VariableDeclaration* with an *Initializer* is assigned the value of its *Initializer*'s *AssignmentExpression* when the *VariableDeclaration* is executed, not when the variable is created.

#### Syntax

```

VariableStatement[Yield, Await] :
    var VariableDeclarationList[+In, ?Yield, ?Await] ;

VariableDeclarationList[In, Yield, Await] :
    VariableDeclaration[?In, ?Yield, ?Await]
    VariableDeclarationList[?In, ?Yield, ?Await] ,
    VariableDeclaration[?In, ?Yield, ?Await]

VariableDeclaration[In, Yield, Await] :
    BindingIdentifier[?Yield, ?Await] Initializer[?In, ?Yield, ?Await] opt
    BindingPattern[?Yield, ?Await] Initializer[?In, ?Yield, ?Await]
  
```

### 14.3.2.1 Runtime Semantics: Evaluation

*VariableStatement* : **var** *VariableDeclarationList* ;

1. Perform ? [Evaluation](#) of *VariableDeclarationList*.
2. Return empty.

*VariableDeclarationList* : *VariableDeclarationList* , *VariableDeclaration*

1. Perform ? [Evaluation](#) of *VariableDeclarationList*.
2. Return ? [Evaluation](#) of *VariableDeclaration*.

*VariableDeclaration* : *BindingIdentifier*

1. Return empty.

*VariableDeclaration* : *BindingIdentifier* *Initializer*

1. Let *bindingId* be [StringValue](#) of *BindingIdentifier*.
2. Let *lhs* be ? [ResolveBinding](#)(*bindingId*).
3. If [IsAnonymousFunctionDefinition](#)(*Initializer*) is **true**, then
  - a. Let *value* be ? [NamedEvaluation](#) of *Initializer* with argument *bindingId*.
4. Else,
  - a. Let *rhs* be ? [Evaluation](#) of *Initializer*.
  - b. Let *value* be ? [GetValue](#)(*rhs*).
5. Perform ? [PutValue](#)(*lhs*, *value*).
6. Return empty.

**NOTE** If a *VariableDeclaration* is nested within a *with* statement and the *BindingIdentifier* in the *VariableDeclaration* is the same as a [property name](#) of the binding object of the *with* statement's [Object Environment Record](#), then step 5 will assign *value* to the property instead of assigning to the [VariableEnvironment](#) binding of the *Identifier*.

*VariableDeclaration* : *BindingPattern* *Initializer*

1. Let *rhs* be ? [Evaluation](#) of *Initializer*.
2. Let *rval* be ? [GetValue](#)(*rhs*).
3. Return ? [BindingInitialization](#) of *BindingPattern* with arguments *rval* and **undefined**.

### 14.3.3 Destructuring Binding Patterns

#### Syntax

```

BindingPattern[Yield, Await] :
  ObjectBindingPattern[?Yield, ?Await]
  ArrayBindingPattern[?Yield, ?Await]

ObjectBindingPattern[Yield, Await] :
  { }
  { BindingRestProperty[?Yield, ?Await] }
  { BindingPropertyList[?Yield, ?Await] }
  { BindingPropertyList[?Yield, ?Await] , BindingRestProperty[?Yield, ?Await] opt }
  
```

```

ArrayBindingPattern[Yield, Await] :
  [ Elisionopt BindingRestElement[?Yield, ?Await] opt ]
  [ BindingElementList[?Yield, ?Await] ]
  [ BindingElementList[?Yield, ?Await] , Elisionopt
    BindingRestElement[?Yield, ?Await] opt ]

BindingRestProperty[Yield, Await] :
  ... BindingIdentifier[?Yield, ?Await]

BindingPropertyList[Yield, Await] :
  BindingProperty[?Yield, ?Await]
  BindingPropertyList[?Yield, ?Await] , BindingProperty[?Yield, ?Await]

BindingElementList[Yield, Await] :
  BindingElisionElement[?Yield, ?Await]
  BindingElementList[?Yield, ?Await] , BindingElisionElement[?Yield, ?Await]

BindingElisionElement[Yield, Await] :
  Elisionopt BindingElement[?Yield, ?Await]

BindingProperty[Yield, Await] :
  SingleNameBinding[?Yield, ?Await]
  PropertyName[?Yield, ?Await] : BindingElement[?Yield, ?Await]

BindingElement[Yield, Await] :
  SingleNameBinding[?Yield, ?Await]
  BindingPattern[?Yield, ?Await] Initializer[+In, ?Yield, ?Await] opt

SingleNameBinding[Yield, Await] :
  BindingIdentifier[?Yield, ?Await] Initializer[+In, ?Yield, ?Await] opt

BindingRestElement[Yield, Await] :
  ... BindingIdentifier[?Yield, ?Await]
  ... BindingPattern[?Yield, ?Await]

```

### 14.3.3.1 Runtime Semantics: PropertyBindingInitialization

The [syntax-directed operation](#) `PropertyBindingInitialization` takes arguments *value* (an ECMAScript language value) and *environment* (an [Environment Record](#) or **undefined**) and returns either a [normal completion](#) containing a [List](#) of [property keys](#) or an [abrupt completion](#). It collects a list of all bound property names. It is defined piecewise over the following productions:

*BindingPropertyList* : *BindingPropertyList* , *BindingProperty*

1. Let *boundNames* be ? [PropertyBindingInitialization](#) of *BindingPropertyList* with arguments *value* and *environment*.
2. Let *nextNames* be ? [PropertyBindingInitialization](#) of *BindingProperty* with arguments *value* and *environment*.
3. Return the [list-concatenation](#) of *boundNames* and *nextNames*.

*BindingProperty* : *SingleNameBinding*

1. Let *name* be the sole element of the `BoundNames` of `SingleNameBinding`.
2. Perform ? `KeyedBindingInitialization` of `SingleNameBinding` with arguments *value*, *environment*, and *name*.
3. Return « *name* ».

*BindingProperty* : *PropertyName* : *BindingElement*

1. Let *P* be ? `Evaluation` of *PropertyName*.
2. Perform ? `KeyedBindingInitialization` of *BindingElement* with arguments *value*, *environment*, and *P*.
3. Return « *P* ».

### 14.3.3.2 Runtime Semantics: RestBindingInitialization

The `syntax-directed operation` `RestBindingInitialization` takes arguments *value* (an ECMAScript language value), *environment* (an `Environment Record` or `undefined`), and *excludedNames* (a List of property keys) and returns either a `normal completion containing unused` or an `abrupt completion`. It is defined piecewise over the following productions:

*BindingRestProperty* : ... *BindingIdentifier*

1. Let *lhs* be ? `ResolveBinding`(`StringValue` of *BindingIdentifier*, *environment*).
2. Let *restObj* be `OrdinaryObjectCreate`(`%Object.prototype%`).
3. Perform ? `CopyDataProperties`(*restObj*, *value*, *excludedNames*).
4. If *environment* is `undefined`, return ? `PutValue`(*lhs*, *restObj*).
5. Return ? `InitializeReferencedBinding`(*lhs*, *restObj*).

### 14.3.3.3 Runtime Semantics: KeyedBindingInitialization

The `syntax-directed operation` `KeyedBindingInitialization` takes arguments *value* (an ECMAScript language value), *environment* (an `Environment Record` or `undefined`), and *propertyName* (a property key) and returns either a `normal completion containing unused` or an `abrupt completion`.

**NOTE** When `undefined` is passed for *environment* it indicates that a `PutValue` operation should be used to assign the initialization value. This is the case for formal parameter lists of `non-strict functions`. In that case the formal parameter bindings are preinitialized in order to deal with the possibility of multiple parameters with the same name.

It is defined piecewise over the following productions:

*BindingElement* : *BindingPattern* *Initializer*<sub>opt</sub>

1. Let *v* be ? `GetV`(*value*, *propertyName*).
2. If *Initializer* is present and *v* is `undefined`, then
  - a. Let *defaultValue* be ? `Evaluation` of *Initializer*.
  - b. Set *v* to ? `GetValue`(*defaultValue*).
3. Return ? `BindingInitialization` of *BindingPattern* with arguments *v* and *environment*.

*SingleNameBinding* : *BindingIdentifier* *Initializer*<sub>opt</sub>

1. Let *bindingId* be `StringValue` of *BindingIdentifier*.
2. Let *lhs* be ? `ResolveBinding`(*bindingId*, *environment*).
3. Let *v* be ? `GetV`(*value*, *propertyName*).
4. If *Initializer* is present and *v* is `undefined`, then

- a. If `IsAnonymousFunctionDefinition(Initializer)` is **true**, then
    - i. Set `v` to ? `NamedEvaluation` of `Initializer` with argument `bindingId`.
  - b. Else,
    - i. Let `defaultValue` be ? `Evaluation` of `Initializer`.
    - ii. Set `v` to ? `GetValue`(`defaultValue`).
5. If `environment` is **undefined**, return ? `PutValue`(`lhs`, `v`).
  6. Return ? `InitializeReferencedBinding`(`lhs`, `v`).

## 14.4 Empty Statement

### Syntax

```
EmptyStatement :
    ;
```

### 14.4.1 Runtime Semantics: Evaluation

```
EmptyStatement : ;
```

1. Return empty.

## 14.5 Expression Statement

### Syntax

```
ExpressionStatement[yield, Await] :
    [lookahead ∉ { { , function , async [no LineTerminator here] function , class , let [
    ] } } ] Expression[+In, ?Yield, ?Await] ;
```

**NOTE** An *ExpressionStatement* cannot start with a U+007B (LEFT CURLY BRACKET) because that might make it ambiguous with a *Block*. An *ExpressionStatement* cannot start with the **function** or **class** keywords because that would make it ambiguous with a *FunctionDeclaration*, a *GeneratorDeclaration*, or a *ClassDeclaration*. An *ExpressionStatement* cannot start with **async function** because that would make it ambiguous with an *AsyncFunctionDeclaration* or a *AsyncGeneratorDeclaration*. An *ExpressionStatement* cannot start with the two token sequence **let** [ because that would make it ambiguous with a **let** *LexicalDeclaration* whose first *LexicalBinding* was an *ArrayBindingPattern*.

### 14.5.1 Runtime Semantics: Evaluation

```
ExpressionStatement : Expression ;
```

1. Let `exprRef` be ? `Evaluation` of `Expression`.
2. Return ? `GetValue`(`exprRef`).

## 14.6 The if Statement

## Syntax

```

IfStatement[Yield, Await, Return] :
    if ( Expression[+In, ?Yield, ?Await] ) Statement[?Yield, ?Await, ?Return] else
        Statement[?Yield, ?Await, ?Return]
    if ( Expression[+In, ?Yield, ?Await] ) Statement[?Yield, ?Await, ?Return]
        [lookahead ≠ else]

```

**NOTE** The lookahead-restriction [lookahead ≠ **else**] resolves the classic "dangling else" problem in the usual way. That is, when the choice of associated **if** is otherwise ambiguous, the **else** is associated with the nearest (innermost) of the candidate **ifs**

### 14.6.1 Static Semantics: Early Errors

*IfStatement* : **if** ( *Expression* ) *Statement* **else** *Statement*

- It is a Syntax Error if *IsLabelledFunction*(the first *Statement*) is **true**.
- It is a Syntax Error if *IsLabelledFunction*(the second *Statement*) is **true**.

*IfStatement* : **if** ( *Expression* ) *Statement*

- It is a Syntax Error if *IsLabelledFunction*(*Statement*) is **true**.

**NOTE** It is only necessary to apply this rule if the extension specified in B.3.1 is implemented.

### 14.6.2 Runtime Semantics: Evaluation

*IfStatement* : **if** ( *Expression* ) *Statement* **else** *Statement*

1. Let *exprRef* be ? *Evaluation* of *Expression*.
2. Let *exprValue* be *ToBoolean*(? *GetValue*(*exprRef*)).
3. If *exprValue* is **true**, then
  - a. Let *stmtCompletion* be *Completion*(*Evaluation* of the first *Statement*).
4. Else,
  - a. Let *stmtCompletion* be *Completion*(*Evaluation* of the second *Statement*).
5. Return ? *UpdateEmpty*(*stmtCompletion*, **undefined**).

*IfStatement* : **if** ( *Expression* ) *Statement*

1. Let *exprRef* be ? *Evaluation* of *Expression*.
2. Let *exprValue* be *ToBoolean*(? *GetValue*(*exprRef*)).
3. If *exprValue* is **false**, then
  - a. Return **undefined**.
4. Else,
  - a. Let *stmtCompletion* be *Completion*(*Evaluation* of *Statement*).
  - b. Return ? *UpdateEmpty*(*stmtCompletion*, **undefined**).

## 14.7 Iteration Statements

### Syntax

```

IterationStatement[Yield, Await, Return] :

```



```

DoWhileStatement[?Yield, ?Await, ?Return]
WhileStatement[?Yield, ?Await, ?Return]
ForStatement[?Yield, ?Await, ?Return]
ForInOfStatement[?Yield, ?Await, ?Return]

```

## 14.7.1 Semantics

### 14.7.1.1 LoopContinues ( *completion*, *labelSet* )

The abstract operation LoopContinues takes arguments *completion* (a Completion Record) and *labelSet* (a List of Strings) and returns a Boolean. It performs the following steps when called:

1. If *completion*.[[Type]] is normal, return **true**.
2. If *completion*.[[Type]] is not continue, return **false**.
3. If *completion*.[[Target]] is empty, return **true**.
4. If *labelSet* contains *completion*.[[Target]], return **true**.
5. Return **false**.

**NOTE** Within the *Statement* part of an *IterationStatement* a *ContinueStatement* may be used to begin a new iteration.

### 14.7.1.2 Runtime Semantics: LoopEvaluation

The *syntax-directed operation* LoopEvaluation takes argument *labelSet* (a List of Strings) and returns either a *normal completion containing an ECMAScript language value* or an *abrupt completion*. It is defined piecewise over the following productions:

*IterationStatement* : *DoWhileStatement*

1. Return ? *DoWhileLoopEvaluation* of *DoWhileStatement* with argument *labelSet*.

*IterationStatement* : *WhileStatement*

1. Return ? *WhileLoopEvaluation* of *WhileStatement* with argument *labelSet*.

*IterationStatement* : *ForStatement*

1. Return ? *ForLoopEvaluation* of *ForStatement* with argument *labelSet*.

*IterationStatement* : *ForInOfStatement*

1. Return ? *ForInOfLoopEvaluation* of *ForInOfStatement* with argument *labelSet*.

## 14.7.2 The do-while Statement

### Syntax

```

DoWhileStatement[Yield, Await, Return] :
  do Statement[?Yield, ?Await, ?Return] while ( Expression[+In, ?Yield, ?Await]
  ) ;

```

### 14.7.2.1 Static Semantics: Early Errors

*DoWhileStatement* : **do** *Statement* **while** ( *Expression* ) ;

- It is a Syntax Error if `IsLabelledFunction(Statement)` is **true**.

NOTE It is only necessary to apply this rule if the extension specified in B.3.1 is implemented.

### 14.7.2.2 Runtime Semantics: DoWhileLoopEvaluation

The [syntax-directed operation](#) `DoWhileLoopEvaluation` takes argument *labelSet* (a List of Strings) and returns either a [normal completion containing an ECMAScript language value](#) or an [abrupt completion](#). It is defined piecewise over the following productions:

*DoWhileStatement* : **do** *Statement* **while** ( *Expression* ) ;

1. Let *V* be **undefined**.
2. Repeat,
  - a. Let *stmtResult* be `Completion(Evaluation of Statement)`.
  - b. If `LoopContinues(stmtResult, labelSet)` is **false**, return ? `UpdateEmpty(stmtResult, V)`.
  - c. If *stmtResult*.[[Value]] is not empty, set *V* to *stmtResult*.[[Value]].
  - d. Let *exprRef* be ? `Evaluation of Expression`.
  - e. Let *exprValue* be ? `GetValue(exprRef)`.
  - f. If `ToBoolean(exprValue)` is **false**, return *V*.

### 14.7.3 The while Statement

#### Syntax

*WhileStatement*<sub>[yield, Await, Return]</sub> :  
**while** ( *Expression*<sub>[+In, ?Yield, ?Await]</sub> ) *Statement*<sub>[?Yield, ?Await, ?Return]</sub>

### 14.7.3.1 Static Semantics: Early Errors

*WhileStatement* : **while** ( *Expression* ) *Statement*

- It is a Syntax Error if `IsLabelledFunction(Statement)` is **true**.

NOTE It is only necessary to apply this rule if the extension specified in B.3.1 is implemented.

### 14.7.3.2 Runtime Semantics: WhileLoopEvaluation

The [syntax-directed operation](#) `WhileLoopEvaluation` takes argument *labelSet* (a List of Strings) and returns either a [normal completion containing an ECMAScript language value](#) or an [abrupt completion](#). It is defined piecewise over the following productions:

*WhileStatement* : **while** ( *Expression* ) *Statement*

1. Let *V* be **undefined**.
2. Repeat,
  - a. Let *exprRef* be ? `Evaluation of Expression`.
  - b. Let *exprValue* be ? `GetValue(exprRef)`.

- c. If `ToBoolean(exprValue)` is **false**, return *V*.
- d. Let *stmtResult* be `Completion(Evaluation of Statement)`.
- e. If `LoopContinues(stmtResult, labelSet)` is **false**, return ? `UpdateEmpty(stmtResult, V)`.
- f. If `stmtResult.[[Value]]` is not empty, set *V* to `stmtResult.[[Value]]`.

## 14.7.4 The for Statement

### Syntax

```

ForStatement[Yield, Await, Return] :
  for ( [lookahead ≠ let [] Expression[-In, ?Yield, ?Await] opt ;
        Expression[+In, ?Yield, ?Await] opt ; Expression[+In, ?Yield, ?Await] opt )
        Statement[?Yield, ?Await, ?Return]
  for ( var VariableDeclarationList[-In, ?Yield, ?Await] ;
        Expression[+In, ?Yield, ?Await] opt ; Expression[+In, ?Yield, ?Await] opt )
        Statement[?Yield, ?Await, ?Return]
  for ( LexicalDeclaration[-In, ?Yield, ?Await] Expression[+In, ?Yield, ?Await] opt
        ; Expression[+In, ?Yield, ?Await] opt ) Statement[?Yield, ?Await, ?Return]

```

### 14.7.4.1 Static Semantics: Early Errors

*ForStatement* :

```

for ( Expressionopt ; Expressionopt ; Expressionopt ) Statement
for ( var VariableDeclarationList ; Expressionopt ; Expressionopt ) Statement
for ( LexicalDeclaration Expressionopt ; Expressionopt ) Statement

```

- It is a Syntax Error if `IsLabelledFunction(Statement)` is **true**.

**NOTE** It is only necessary to apply this rule if the extension specified in B.3.1 is implemented.

*ForStatement* : `for ( LexicalDeclaration Expressionopt ; Expressionopt ) Statement`

- It is a Syntax Error if any element of the `BoundNames` of *LexicalDeclaration* also occurs in the `VarDeclaredNames` of *Statement*.

### 14.7.4.2 Runtime Semantics: ForLoopEvaluation

The `syntax-directed operation` `ForLoopEvaluation` takes argument *labelSet* (a List of Strings) and returns either a `normal completion containing an ECMAScript language value` or an `abrupt completion`. It is defined piecewise over the following productions:

*ForStatement* : `for ( Expressionopt ; Expressionopt ; Expressionopt ) Statement`

1. If the first *Expression* is present, then
  - a. Let *exprRef* be ? `Evaluation` of the first *Expression*.
  - b. Perform ? `GetValue(exprRef)`.
2. If the second *Expression* is present, let *test* be the second *Expression*; otherwise, let *test* be empty.
3. If the third *Expression* is present, let *increment* be the third *Expression*; otherwise, let *increment* be empty.
4. Return ? `ForBodyEvaluation(test, increment, Statement, « », labelSet)`.

*ForStatement* : **for** ( **var** *VariableDeclarationList* ; *Expression*<sub>opt</sub> ; *Expression*<sub>opt</sub> ) *Statement*

1. Perform ? *Evaluation* of *VariableDeclarationList*.
2. If the first *Expression* is present, let *test* be the first *Expression*; otherwise, let *test* be empty.
3. If the second *Expression* is present, let *increment* be the second *Expression*; otherwise, let *increment* be empty.
4. Return ? *ForBodyEvaluation*(*test*, *increment*, *Statement*, « », *labelSet*).

*ForStatement* : **for** ( *LexicalDeclaration* *Expression*<sub>opt</sub> ; *Expression*<sub>opt</sub> ) *Statement*

1. Let *oldEnv* be the *running execution context*'s *LexicalEnvironment*.
2. Let *loopEnv* be *NewDeclarativeEnvironment*(*oldEnv*).
3. Let *isConst* be *IsConstantDeclaration* of *LexicalDeclaration*.
4. Let *boundNames* be the *BoundNames* of *LexicalDeclaration*.
5. For each element *dn* of *boundNames*, do
  - a. If *isConst* is **true**, then
    - i. Perform ! *loopEnv*.*CreateImmutableBinding*(*dn*, **true**).
  - b. Else,
    - i. Perform ! *loopEnv*.*CreateMutableBinding*(*dn*, **false**).
6. Set the *running execution context*'s *LexicalEnvironment* to *loopEnv*.
7. Let *forDcl* be *Completion*(*Evaluation* of *LexicalDeclaration*).
8. If *forDcl* is an *abrupt completion*, then
  - a. Set the *running execution context*'s *LexicalEnvironment* to *oldEnv*.
  - b. Return ? *forDcl*.
9. If *isConst* is **false**, let *perIterationLets* be *boundNames*; otherwise let *perIterationLets* be a new empty *List*.
10. If the first *Expression* is present, let *test* be the first *Expression*; otherwise, let *test* be empty.
11. If the second *Expression* is present, let *increment* be the second *Expression*; otherwise, let *increment* be empty.
12. Let *bodyResult* be *Completion*(*ForBodyEvaluation*(*test*, *increment*, *Statement*, *perIterationLets*, *labelSet*)).
13. Set the *running execution context*'s *LexicalEnvironment* to *oldEnv*.
14. Return ? *bodyResult*.

#### 14.7.4.3 ForBodyEvaluation ( *test*, *increment*, *stmt*, *perIterationBindings*, *labelSet* )

The abstract operation *ForBodyEvaluation* takes arguments *test* (an *Expression Parse Node* or empty), *increment* (an *Expression Parse Node* or empty), *stmt* (a *Statement Parse Node*), *perIterationBindings* (a *List of Strings*), and *labelSet* (a *List of Strings*) and returns either a *normal completion* containing an *ECMAScript language value* or an *abrupt completion*. It performs the following steps when called:

1. Let *V* be **undefined**.
2. Perform ? *CreatePerIterationEnvironment*(*perIterationBindings*).
3. Repeat,
  - a. If *test* is not empty, then
    - i. Let *testRef* be ? *Evaluation* of *test*.
    - ii. Let *testValue* be ? *GetValue*(*testRef*).
    - iii. If *ToBoolean*(*testValue*) is **false**, return *V*.
  - b. Let *result* be *Completion*(*Evaluation* of *stmt*).
  - c. If *LoopContinues*(*result*, *labelSet*) is **false**, return ? *UpdateEmpty*(*result*, *V*).
  - d. If *result*.[[*Value*]] is not empty, set *V* to *result*.[[*Value*]].
  - e. Perform ? *CreatePerIterationEnvironment*(*perIterationBindings*).

- f. If *increment* is not empty, then
  - i. Let *incRef* be ? Evaluation of *increment*.
  - ii. Perform ? *GetValue*(*incRef*).

#### 14.7.4.4 CreatePerIterationEnvironment ( *perIterationBindings* )

The abstract operation *CreatePerIterationEnvironment* takes argument *perIterationBindings* (a List of Strings) and returns either a normal completion containing unused or a throw completion. It performs the following steps when called:

1. If *perIterationBindings* has any elements, then
  - a. Let *lastIterationEnv* be the running execution context's *LexicalEnvironment*.
  - b. Let *outer* be *lastIterationEnv*.[*OuterEnv*].
  - c. Assert: *outer* is not null.
  - d. Let *thisIterationEnv* be *NewDeclarativeEnvironment*(*outer*).
  - e. For each element *bn* of *perIterationBindings*, do
    - i. Perform ! *thisIterationEnv*.*CreateMutableBinding*(*bn*, false).
    - ii. Let *lastValue* be ? *lastIterationEnv*.*GetBindingValue*(*bn*, true).
    - iii. Perform ! *thisIterationEnv*.*InitializeBinding*(*bn*, *lastValue*).
  - f. Set the running execution context's *LexicalEnvironment* to *thisIterationEnv*.
2. Return unused.

#### 14.7.5 The for-in, for-of, and for-await-of Statements

##### Syntax

```

ForInOfStatement[Yield, Await, Return] :
  for ( [lookahead ≠ let] LeftHandSideExpression[?Yield, ?Await] in
    Expression[+In, ?Yield, ?Await] ) Statement[?Yield, ?Await, ?Return]
  for ( var ForBinding[?Yield, ?Await] in Expression[+In, ?Yield, ?Await] )
    Statement[?Yield, ?Await, ?Return]
  for ( ForDeclaration[?Yield, ?Await] in Expression[+In, ?Yield, ?Await] )
    Statement[?Yield, ?Await, ?Return]
  for ( [lookahead ∉ { let, async of}] LeftHandSideExpression[?Yield, ?Await] of
    AssignmentExpression[+In, ?Yield, ?Await] )
    Statement[?Yield, ?Await, ?Return]
  for ( var ForBinding[?Yield, ?Await] of
    AssignmentExpression[+In, ?Yield, ?Await] )
    Statement[?Yield, ?Await, ?Return]
  for ( ForDeclaration[?Yield, ?Await] of
    AssignmentExpression[+In, ?Yield, ?Await] )
    Statement[?Yield, ?Await, ?Return]
  [+Await] for await ( [lookahead ≠ let] LeftHandSideExpression[?Yield, ?Await] of
    AssignmentExpression[+In, ?Yield, ?Await] )
    Statement[?Yield, ?Await, ?Return]
  [+Await] for await ( var ForBinding[?Yield, ?Await] of
    AssignmentExpression[+In, ?Yield, ?Await] )
    Statement[?Yield, ?Await, ?Return]

```

```
[+Await] for await ( ForDeclaration[?Yield, ?Await] of
  AssignmentExpression[+In, ?Yield, ?Await] )
  Statement[?Yield, ?Await, ?Return]
```

```
ForDeclaration[Yield, Await] :
  LetOrConst ForBinding[?Yield, ?Await]
```

```
ForBinding[Yield, Await] :
  BindingIdentifier[?Yield, ?Await]
  BindingPattern[?Yield, ?Await]
```

NOTE This section is extended by Annex B.3.5.

### 14.7.5.1 Static Semantics: Early Errors

*ForInOfStatement* :

```
for ( LeftHandSideExpression in Expression ) Statement
for ( var ForBinding in Expression ) Statement
for ( ForDeclaration in Expression ) Statement
for ( LeftHandSideExpression of AssignmentExpression ) Statement
for ( var ForBinding of AssignmentExpression ) Statement
for ( ForDeclaration of AssignmentExpression ) Statement
for await ( LeftHandSideExpression of AssignmentExpression ) Statement
for await ( var ForBinding of AssignmentExpression ) Statement
for await ( ForDeclaration of AssignmentExpression ) Statement
```

- It is a Syntax Error if `IsLabelledFunction(Statement)` is **true**.

NOTE It is only necessary to apply this rule if the extension specified in B.3.1 is implemented.

*ForInOfStatement* :

```
for ( LeftHandSideExpression in Expression ) Statement
for ( LeftHandSideExpression of AssignmentExpression ) Statement
for await ( LeftHandSideExpression of AssignmentExpression ) Statement
```

If *LeftHandSideExpression* is either an *ObjectLiteral* or an *ArrayLiteral*, the following Early Error rules are applied:

- *LeftHandSideExpression* **must cover** an *AssignmentPattern*.

If *LeftHandSideExpression* is neither an *ObjectLiteral* nor an *ArrayLiteral*, the following Early Error rule is applied:

- It is a Syntax Error if `AssignmentTargetType` of *LeftHandSideExpression* is not simple.

*ForInOfStatement* :

```
for ( ForDeclaration in Expression ) Statement
for ( ForDeclaration of AssignmentExpression ) Statement
for await ( ForDeclaration of AssignmentExpression ) Statement
```

- It is a Syntax Error if the `BoundNames` of *ForDeclaration* contains **"let"**.
- It is a Syntax Error if any element of the `BoundNames` of *ForDeclaration* also occurs in the `VarDeclaredNames` of *Statement*.
- It is a Syntax Error if the `BoundNames` of *ForDeclaration* contains any duplicate entries.

### 14.7.5.2 Static Semantics: IsDestructuring

The [syntax-directed operation](#) `IsDestructuring` takes no arguments and returns a Boolean. It is defined piecewise over the following productions:

*MemberExpression* : *PrimaryExpression*

1. If *PrimaryExpression* is either an *ObjectLiteral* or an *ArrayLiteral*, return **true**.
2. Return **false**.

*MemberExpression* :

*MemberExpression* [ *Expression* ]  
*MemberExpression* . *IdentifierName*  
*MemberExpression* *TemplateLiteral*  
*SuperProperty*  
*MetaProperty*  
**new** *MemberExpression* *Arguments*  
*MemberExpression* . *PrivateIdentifier*

*NewExpression* :

**new** *NewExpression*

*LeftHandSideExpression* :

*CallExpression*  
*OptionalExpression*

1. Return **false**.

*ForDeclaration* : *LetOrConst ForBinding*

1. Return `IsDestructuring` of *ForBinding*.

*ForBinding* : *BindingIdentifier*

1. Return **false**.

*ForBinding* : *BindingPattern*

1. Return **true**.

**NOTE** This section is extended by Annex [B.3.5](#).

### 14.7.5.3 Runtime Semantics: ForDeclarationBindingInitialization

The [syntax-directed operation](#) `ForDeclarationBindingInitialization` takes arguments *value* (an [ECMAScript language value](#)) and *environment* (an [Environment Record](#) or **undefined**) and returns either a [normal completion containing unused](#) or an [abrupt completion](#).

**NOTE** **undefined** is passed for *environment* to indicate that a [PutValue](#) operation should be used to assign the initialization value. This is the case for **var** statements and the formal parameter lists of some [non-strict functions](#) (see [10.2.11](#)). In those cases a lexical binding is hoisted and preinitialized prior to evaluation of its initializer.

It is defined piecewise over the following productions:

*ForDeclaration* : *LetOrConst ForBinding*

1. Return ? [BindingInitialization](#) of *ForBinding* with arguments *value* and *environment*.

#### 14.7.5.4 Runtime Semantics: ForDeclarationBindingInstantiation

The [syntax-directed operation](#) *ForDeclarationBindingInstantiation* takes argument *environment* (a [Declarative Environment Record](#)) and returns unused. It is defined piecewise over the following productions:

*ForDeclaration* : *LetOrConst ForBinding*

1. For each element *name* of the [BoundNames](#) of *ForBinding*, do
  - a. If [IsConstantDeclaration](#) of *LetOrConst* is **true**, then
    - i. Perform ! [environment](#).[CreateImmutableBinding](#)(*name*, **true**).
  - b. Else,
    - i. Perform ! [environment](#).[CreateMutableBinding](#)(*name*, **false**).
2. Return unused.

#### 14.7.5.5 Runtime Semantics: ForInOfLoopEvaluation

The [syntax-directed operation](#) *ForInOfLoopEvaluation* takes argument *labelSet* (a [List](#) of Strings) and returns either a [normal completion](#) containing an [ECMAScript language value](#) or an [abrupt completion](#). It is defined piecewise over the following productions:

*ForInOfStatement* : **for** ( *LeftHandSideExpression in Expression* ) *Statement*

1. Let *keyResult* be ? [ForIn/OfHeadEvaluation](#)(« », *Expression*, [enumerate](#)).
2. Return ? [ForIn/OfBodyEvaluation](#)(*LeftHandSideExpression*, *Statement*, *keyResult*, [enumerate](#), [assignment](#), *labelSet*).

*ForInOfStatement* : **for** ( **var** *ForBinding in Expression* ) *Statement*

1. Let *keyResult* be ? [ForIn/OfHeadEvaluation](#)(« », *Expression*, [enumerate](#)).
2. Return ? [ForIn/OfBodyEvaluation](#)(*ForBinding*, *Statement*, *keyResult*, [enumerate](#), *varBinding*, *labelSet*).

*ForInOfStatement* : **for** ( *ForDeclaration in Expression* ) *Statement*

1. Let *keyResult* be ? [ForIn/OfHeadEvaluation](#)([BoundNames](#) of *ForDeclaration*, *Expression*, [enumerate](#)).
2. Return ? [ForIn/OfBodyEvaluation](#)(*ForDeclaration*, *Statement*, *keyResult*, [enumerate](#), [lexicalBinding](#), *labelSet*).

*ForInOfStatement* : **for** ( *LeftHandSideExpression of AssignmentExpression* ) *Statement*

1. Let *keyResult* be ? [ForIn/OfHeadEvaluation](#)(« », *AssignmentExpression*, [iterate](#)).
2. Return ? [ForIn/OfBodyEvaluation](#)(*LeftHandSideExpression*, *Statement*, *keyResult*, [iterate](#), [assignment](#), *labelSet*).

*ForInOfStatement* : **for** ( **var** *ForBinding of AssignmentExpression* ) *Statement*

1. Let *keyResult* be ? [ForIn/OfHeadEvaluation](#)(« », *AssignmentExpression*, [iterate](#)).
2. Return ? [ForIn/OfBodyEvaluation](#)(*ForBinding*, *Statement*, *keyResult*, [iterate](#), *varBinding*, *labelSet*).

*ForInOfStatement* : **for** ( *ForDeclaration of AssignmentExpression* ) *Statement*

1. Let *keyResult* be ? [ForIn/OfHeadEvaluation](#)([BoundNames](#) of *ForDeclaration*, *AssignmentExpression*, [iterate](#)).



2. Return ? *ForIn/OfBodyEvaluation*(*ForDeclaration*, *Statement*, *keyResult*, *iterate*, *lexicalBinding*, *labelSet*).

*ForInOfStatement*: **for await** ( *LeftHandSideExpression* **of** *AssignmentExpression* ) *Statement*

1. Let *keyResult* be ? *ForIn/OfHeadEvaluation*(« », *AssignmentExpression*, *async-iterate*).
2. Return ? *ForIn/OfBodyEvaluation*(*LeftHandSideExpression*, *Statement*, *keyResult*, *iterate*, *assignment*, *labelSet*, *async*).

*ForInOfStatement*: **for await** ( **var** *ForBinding* **of** *AssignmentExpression* ) *Statement*

1. Let *keyResult* be ? *ForIn/OfHeadEvaluation*(« », *AssignmentExpression*, *async-iterate*).
2. Return ? *ForIn/OfBodyEvaluation*(*ForBinding*, *Statement*, *keyResult*, *iterate*, *varBinding*, *labelSet*, *async*).

*ForInOfStatement*: **for await** ( *ForDeclaration* **of** *AssignmentExpression* ) *Statement*

1. Let *keyResult* be ? *ForIn/OfHeadEvaluation*(*BoundNames* of *ForDeclaration*, *AssignmentExpression*, *async-iterate*).
2. Return ? *ForIn/OfBodyEvaluation*(*ForDeclaration*, *Statement*, *keyResult*, *iterate*, *lexicalBinding*, *labelSet*, *async*).

NOTE This section is extended by Annex B.3.5.

#### 14.7.5.6 ForIn/OfHeadEvaluation ( *uninitializedBoundNames*, *expr*, *iterationKind* )

The abstract operation *ForIn/OfHeadEvaluation* takes arguments *uninitializedBoundNames* (a List of Strings), *expr* (an *Expression Parse Node* or an *AssignmentExpression Parse Node*), and *iterationKind* (enumerate, iterate, or async-iterate) and returns either a normal completion containing an Iterator Record or an abrupt completion. It performs the following steps when called:

1. Let *oldEnv* be the running execution context's *LexicalEnvironment*.
2. If *uninitializedBoundNames* is not empty, then
  - a. Assert: *uninitializedBoundNames* has no duplicate entries.
  - b. Let *newEnv* be *NewDeclarativeEnvironment*(*oldEnv*).
  - c. For each String *name* of *uninitializedBoundNames*, do
    - i. Perform ! *newEnv*.*CreateMutableBinding*(*name*, **false**).
  - d. Set the running execution context's *LexicalEnvironment* to *newEnv*.
3. Let *exprRef* be *Completion*(*Evaluation* of *expr*).
4. Set the running execution context's *LexicalEnvironment* to *oldEnv*.
5. Let *exprValue* be ? *GetValue*(? *exprRef*).
6. If *iterationKind* is enumerate, then
  - a. If *exprValue* is either **undefined** or **null**, then
    - i. Return *Completion Record* { *[[Type]]*: break, *[[Value]]*: empty, *[[Target]]*: empty }.
  - b. Let *obj* be ! *ToObject*(*exprValue*).
  - c. Let *iterator* be *EnumerateObjectProperties*(*obj*).
  - d. Let *nextMethod* be ! *GetV*(*iterator*, "next").
  - e. Return the *Iterator Record* { *[[Iterator]]*: *iterator*, *[[NextMethod]]*: *nextMethod*, *[[Done]]*: **false** }.
7. Else,
  - a. Assert: *iterationKind* is either iterate or async-iterate.
  - b. If *iterationKind* is async-iterate, let *iteratorKind* be *async*.
  - c. Else, let *iteratorKind* be *sync*.
  - d. Return ? *GetIterator*(*exprValue*, *iteratorKind*).

### 14.7.5.7 ForIn/OfBodyEvaluation ( *lhs*, *stmt*, *iteratorRecord*, *iterationKind*, *lhsKind*, *labelSet* [ , *iteratorKind* ] )

The abstract operation ForIn/OfBodyEvaluation takes arguments *lhs* (a [Parse Node](#)), *stmt* (a [Statement Parse Node](#)), *iteratorRecord* (an [Iterator Record](#)), *iterationKind* (enumerate or iterate), *lhsKind* (assignment, varBinding, or lexicalBinding), and *labelSet* (a [List of Strings](#)) and optional argument *iteratorKind* (sync or async) and returns either a [normal completion](#) containing an [ECMAScript language value](#) or an [abrupt completion](#). It performs the following steps when called:

1. If *iteratorKind* is not present, set *iteratorKind* to sync.
2. Let *oldEnv* be the [running execution context](#)'s [LexicalEnvironment](#).
3. Let *V* be **undefined**.
4. Let *destructuring* be [IsDestructuring](#) of *lhs*.
5. If *destructuring* is **true** and *lhsKind* is assignment, then
  - a. **Assert**: *lhs* is a [LeftHandSideExpression](#).
  - b. Let *assignmentPattern* be the [AssignmentPattern](#) that is [covered](#) by *lhs*.
6. Repeat,
  - a. Let *nextResult* be ? [Call](#)(*iteratorRecord*.[[NextMethod]], *iteratorRecord*.[[Iterator]]).
  - b. If *iteratorKind* is async, set *nextResult* to ? [Await](#)(*nextResult*).
  - c. If *nextResult* is not an [Object](#), throw a **TypeError** exception.
  - d. Let *done* be ? [IteratorComplete](#)(*nextResult*).
  - e. If *done* is **true**, return *V*.
  - f. Let *nextValue* be ? [IteratorValue](#)(*nextResult*).
  - g. If *lhsKind* is either assignment or varBinding, then
    - i. If *destructuring* is **true**, then
      1. If *lhsKind* is assignment, then
        - a. Let *status* be [Completion](#)([DestructuringAssignmentEvaluation](#) of *assignmentPattern* with argument *nextValue*).
      2. Else,
        - a. **Assert**: *lhsKind* is varBinding.
        - b. **Assert**: *lhs* is a [ForBinding](#).
        - c. Let *status* be [Completion](#)([BindingInitialization](#) of *lhs* with arguments *nextValue* and **undefined**).
    - ii. Else,
      1. Let *lhsRef* be [Completion](#)([Evaluation](#) of *lhs*). (It may be evaluated repeatedly.)
      2. If *lhsRef* is an [abrupt completion](#), then
        - a. Let *status* be *lhsRef*.
      3. Else,
        - a. Let *status* be [Completion](#)([PutValue](#)(*lhsRef*.[[Value]], *nextValue*)).
  - h. Else,
    - i. **Assert**: *lhsKind* is lexicalBinding.
    - ii. **Assert**: *lhs* is a [ForDeclaration](#).
    - iii. Let *iterationEnv* be [NewDeclarativeEnvironment](#)(*oldEnv*).
    - iv. Perform [ForDeclarationBindingInstantiation](#) of *lhs* with argument *iterationEnv*.
    - v. Set the [running execution context](#)'s [LexicalEnvironment](#) to *iterationEnv*.
    - vi. If *destructuring* is **true**, then
      1. Let *status* be [Completion](#)([ForDeclarationBindingInitialization](#) of *lhs* with arguments *nextValue* and *iterationEnv*).
    - vii. Else,
      1. **Assert**: *lhs* binds a single name.
      2. Let *lhsName* be the sole element of [BoundNames](#) of *lhs*.

3. Let *lhsRef* be ! [ResolveBinding](#)(*lhsName*).
4. Let *status* be [Completion](#)([InitializeReferencedBinding](#)(*lhsRef*, *nextValue*)).
- i. If *status* is an [abrupt completion](#), then
  - i. Set the [running execution context](#)'s [LexicalEnvironment](#) to *oldEnv*.
  - ii. If *iteratorKind* is [async](#), return ? [AsyncIteratorClose](#)(*iteratorRecord*, *status*).
  - iii. If *iterationKind* is [enumerate](#), then
    1. Return ? *status*.
  - iv. Else,
    1. [Assert](#): *iterationKind* is [iterate](#).
    2. Return ? [IteratorClose](#)(*iteratorRecord*, *status*).
- j. Let *result* be [Completion](#)([Evaluation](#) of *stmt*).
- k. Set the [running execution context](#)'s [LexicalEnvironment](#) to *oldEnv*.
- l. If [LoopContinues](#)(*result*, *labelSet*) is **false**, then
  - i. If *iterationKind* is [enumerate](#), then
    1. Return ? [UpdateEmpty](#)(*result*, *V*).
  - ii. Else,
    1. [Assert](#): *iterationKind* is [iterate](#).
    2. Set *status* to [Completion](#)([UpdateEmpty](#)(*result*, *V*)).
    3. If *iteratorKind* is [async](#), return ? [AsyncIteratorClose](#)(*iteratorRecord*, *status*).
    4. Return ? [IteratorClose](#)(*iteratorRecord*, *status*).
- m. If *result*.[[Value]] is not empty, set *V* to *result*.[[Value]].

#### 14.7.5.8 Runtime Semantics: Evaluation

*BindingIdentifier* :  
*Identifier*  
**yield**  
**await**

1. Let *bindingId* be [StringValue](#) of *BindingIdentifier*.
2. Return ? [ResolveBinding](#)(*bindingId*).

#### 14.7.5.9 EnumerateObjectProperties ( **O** )

The abstract operation [EnumerateObjectProperties](#) takes argument **O** (an Object) and returns an Iterator. It performs the following steps when called:

1. Return an Iterator object ([27.1.1.2](#)) whose **next** method iterates over all the String-valued keys of enumerable properties of **O**. The iterator object is never directly accessible to ECMAScript code. The mechanics and order of enumerating the properties is not specified but must conform to the rules specified below.

The iterator's **throw** and **return** methods are **null** and are never invoked. The iterator's **next** method processes object properties to determine whether the [property key](#) should be returned as an iterator value. Returned [property keys](#) do not include keys that are Symbols. Properties of the target object may be deleted during enumeration. A property that is deleted before it is processed by the iterator's **next** method is ignored. If new properties are added to the target object during enumeration, the newly added properties are not guaranteed to be processed in the active enumeration. A [property name](#) will be returned by the iterator's **next** method at most once in any enumeration.

Enumerating the properties of the target object includes enumerating properties of its prototype, and the prototype of the prototype, and so on, recursively; but a property of a prototype is not processed if it has the same name as a property that has already been processed by the iterator's **next** method. The values of [\[\[Enumerable\]\]](#) attributes are not considered when determining if a property of a prototype object has already

been processed. The enumerable property names of prototype objects must be obtained by invoking `EnumerateObjectProperties` passing the prototype object as the argument. `EnumerateObjectProperties` must obtain the own [property keys](#) of the target object by calling its `[[OwnPropertyKeys]]` internal method. Property attributes of the target object must be obtained by calling its `[[GetOwnProperty]]` internal method.

In addition, if neither `O` nor any object in its prototype chain is a [Proxy exotic object](#), [Integer-Indexed exotic object](#), [module namespace exotic object](#), or implementation provided [exotic object](#), then the iterator must behave as would the iterator given by `CreateForInIterator(O)` until one of the following occurs:

- the value of the `[[Prototype]]` internal slot of `O` or an object in its prototype chain changes,
- a property is removed from `O` or an object in its prototype chain,
- a property is added to an object in `O`'s prototype chain, or
- the value of the `[[Enumerable]]` attribute of a property of `O` or an object in its prototype chain changes.

NOTE 1 ECMAScript implementations are not required to implement the algorithm in [14.7.5.10.2.1](#) directly. They may choose any implementation whose behaviour will not deviate from that algorithm unless one of the constraints in the previous paragraph is violated.

The following is an informative definition of an ECMAScript generator function that conforms to these rules:

```
function* EnumerateObjectProperties(obj) {
  const visited = new Set();
  for (const key of Reflect.ownKeys(obj)) {
    if (typeof key === "symbol") continue;
    const desc = Reflect.getOwnPropertyDescriptor(obj, key);
    if (desc) {
      visited.add(key);
      if (desc.enumerable) yield key;
    }
  }
  const proto = Reflect.getPrototypeOf(obj);
  if (proto === null) return;
  for (const protoKey of EnumerateObjectProperties(proto)) {
    if (!visited.has(protoKey)) yield protoKey;
  }
}
```

NOTE 2 The list of [exotic objects](#) for which implementations are not required to match `CreateForInIterator` was chosen because implementations historically differed in behaviour for those cases, and agreed in all others.

## 14.7.5.10 For-In Iterator Objects

A For-In Iterator is an object that represents a specific iteration over some specific object. For-In Iterator objects are never directly accessible to ECMAScript code; they exist solely to illustrate the behaviour of `EnumerateObjectProperties`.

### 14.7.5.10.1 CreateForInIterator ( *object* )

The abstract operation `CreateForInIterator` takes argument *object* (an Object) and returns a For-In Iterator. It is used to create a For-In Iterator object which iterates over the own and inherited enumerable string properties of *object* in a specific order. It performs the following steps when called:

1. Let *iterator* be `OrdinaryObjectCreate(%ForInIteratorPrototype%, « [[Object]], [[ObjectWasVisited]], [[VisitedKeys]], [[RemainingKeys]] »)`.
2. Set *iterator*.`[[Object]]` to *object*.

3. Set *iterator*.[[ObjectWasVisited]] to **false**.
4. Set *iterator*.[[VisitedKeys]] to a new empty [List](#).
5. Set *iterator*.[[RemainingKeys]] to a new empty [List](#).
6. Return *iterator*.

#### 14.7.5.10.2 The %ForInIteratorPrototype% Object

The %ForInIteratorPrototype% object:

- has properties that are inherited by all For-In Iterator Objects.
- is an [ordinary object](#).
- has a [[Prototype]] internal slot whose value is %IteratorPrototype%.
- is never directly accessible to ECMAScript code.
- has the following properties:

##### 14.7.5.10.2.1 %ForInIteratorPrototype%.next ( )

1. Let *O* be the **this** value.
2. **Assert**: *O* is an [Object](#).
3. **Assert**: *O* has all of the internal slots of a For-In Iterator Instance ([14.7.5.10.3](#)).
4. Let *object* be *O*.[[Object]].
5. Repeat,
  - a. If *O*.[[ObjectWasVisited]] is **false**, then
    - i. Let *keys* be ? *object*.[[OwnPropertyKeys]]().
    - ii. For each element *key* of *keys*, do
      1. If *key* is a [String](#), then
        - a. Append *key* to *O*.[[RemainingKeys]].
    - iii. Set *O*.[[ObjectWasVisited]] to **true**.
  - b. Repeat, while *O*.[[RemainingKeys]] is not empty,
    - i. Let *r* be the first element of *O*.[[RemainingKeys]].
    - ii. Remove the first element from *O*.[[RemainingKeys]].
    - iii. If there does not exist an element *v* of *O*.[[VisitedKeys]] such that [SameValue](#)(*r*, *v*) is **true**, then
      1. Let *desc* be ? *object*.[[GetOwnProperty]](*r*).
      2. If *desc* is not **undefined**, then
        - a. Append *r* to *O*.[[VisitedKeys]].
        - b. If *desc*.[[Enumerable]] is **true**, return [CreateIterResultObject](#)(*r*, **false**).
  - c. Set *object* to ? *object*.[[GetPrototypeOf]]().
  - d. Set *O*.[[Object]] to *object*.
  - e. Set *O*.[[ObjectWasVisited]] to **false**.
  - f. If *object* is **null**, return [CreateIterResultObject](#)(**undefined**, **true**).

#### 14.7.5.10.3 Properties of For-In Iterator Instances

For-In Iterator instances are [ordinary objects](#) that inherit properties from the %ForInIteratorPrototype% intrinsic object. For-In Iterator instances are initially created with the internal slots listed in [Table 38](#).

Table 38: Internal Slots of For-In Iterator Instances

Internal Slot	Type	Description
[[Object]]	an Object	The Object value whose properties are being iterated.
[[ObjectWasVisited]]	a Boolean	<b>true</b> if the iterator has invoked [[OwnPropertyKeys]] on [[Object]], <b>false</b> otherwise.
[[VisitedKeys]]	a List of Strings	The values that have been emitted by this iterator thus far.
[[RemainingKeys]]	a List of Strings	The values remaining to be emitted for the current object, before iterating the properties of its prototype (if its prototype is not <b>null</b> ).

## 14.8 The continue Statement

### Syntax

```
ContinueStatement[Yield, Await] :
    continue ;
    continue [no LineTerminator here] LabelIdentifier[?Yield, ?Await] ;
```

### 14.8.1 Static Semantics: Early Errors

```
ContinueStatement :
    continue ;
    continue LabelIdentifier ;
```

- It is a Syntax Error if this *ContinueStatement* is not nested, directly or indirectly (but not crossing function or **static** initialization block boundaries), within an *IterationStatement*.

### 14.8.2 Runtime Semantics: Evaluation

```
ContinueStatement : continue ;
```

- Return [Completion Record](#) { [[Type]]: continue, [[Value]]: empty, [[Target]]: empty }.

```
ContinueStatement : continue LabelIdentifier ;
```

- Let *label* be the [StringValue](#) of *LabelIdentifier*.
- Return [Completion Record](#) { [[Type]]: continue, [[Value]]: empty, [[Target]]: *label* }.

## 14.9 The break Statement

### Syntax

```
BreakStatement[Yield, Await] :
    break ;
    break [no LineTerminator here] LabelIdentifier[?Yield, ?Await] ;
```

### 14.9.1 Static Semantics: Early Errors

*BreakStatement* : **break** ;

- It is a Syntax Error if this *BreakStatement* is not nested, directly or indirectly (but not crossing function or **static** initialization block boundaries), within an *IterationStatement* or a *SwitchStatement*.

### 14.9.2 Runtime Semantics: Evaluation

*BreakStatement* : **break** ;

1. Return **Completion Record** { [[Type]]: break, [[Value]]: empty, [[Target]]: empty }.

*BreakStatement* : **break** *LabelIdentifier* ;

1. Let *label* be the **StringValue** of *LabelIdentifier*.
2. Return **Completion Record** { [[Type]]: break, [[Value]]: empty, [[Target]]: *label* }.

## 14.10 The return Statement

### Syntax

*ReturnStatement*<sub>[*Yield*, *Await*]</sub> :

**return** ;

**return** [no *LineTerminator* here] *Expression*<sub>[*+In*, ?*Yield*, ?*Await*]</sub> ;

**NOTE** A **return** statement causes a function to cease execution and, in most cases, returns a value to the caller. If *Expression* is omitted, the return value is **undefined**. Otherwise, the return value is the value of *Expression*. A **return** statement may not actually return a value to the caller depending on surrounding context. For example, in a **try** block, a **return** statement's **Completion Record** may be replaced with another **Completion Record** during evaluation of the **finally** block.

### 14.10.1 Runtime Semantics: Evaluation

*ReturnStatement* : **return** ;

1. Return **Completion Record** { [[Type]]: return, [[Value]]: **undefined**, [[Target]]: empty }.

*ReturnStatement* : **return** *Expression* ;

1. Let *exprRef* be ? **Evaluation** of *Expression*.
2. Let *exprValue* be ? **GetValue**(*exprRef*).
3. If **GetGeneratorKind**() is async, set *exprValue* to ? **Await**(*exprValue*).
4. Return **Completion Record** { [[Type]]: return, [[Value]]: *exprValue*, [[Target]]: empty }.

## LEGACY

### 14.11 The with Statement

NOTE 1 Use of the [Legacy with](#) statement is discouraged in new ECMAScript code. Consider alternatives that are permitted in both [strict mode code](#) and [non-strict code](#), such as [destructuring assignment](#).

#### Syntax

```
WithStatement[Yield, Await, Return] :  
  with ( Expression[+In, ?Yield, ?Await] ) Statement[?Yield, ?Await, ?Return]
```

NOTE 2 The **with** statement adds an [Object Environment Record](#) for a computed object to the lexical environment of the [running execution context](#). It then executes a statement using this augmented lexical environment. Finally, it restores the original lexical environment.

#### 14.11.1 Static Semantics: Early Errors

*WithStatement*: **with** ( *Expression* ) *Statement*

- It is a Syntax Error if the [source text matched by](#) this production is contained in [strict mode code](#).
- It is a Syntax Error if [IsLabelledFunction](#)(*Statement*) is **true**.

NOTE It is only necessary to apply the second rule if the extension specified in [B.3.1](#) is implemented.

#### 14.11.2 Runtime Semantics: Evaluation

*WithStatement*: **with** ( *Expression* ) *Statement*

1. Let *val* be ? [Evaluation](#) of *Expression*.
2. Let *obj* be ? [ToObject](#)(? [GetValue](#)(*val*)).
3. Let *oldEnv* be the [running execution context](#)'s [LexicalEnvironment](#).
4. Let *newEnv* be [NewObjectEnvironment](#)(*obj*, **true**, *oldEnv*).
5. Set the [running execution context](#)'s [LexicalEnvironment](#) to *newEnv*.
6. Let *C* be [Completion](#)([Evaluation](#) of *Statement*).
7. Set the [running execution context](#)'s [LexicalEnvironment](#) to *oldEnv*.
8. Return ? [UpdateEmpty](#)(*C*, **undefined**).

NOTE No matter how control leaves the embedded *Statement*, whether normally or by some form of [abrupt completion](#) or exception, the [LexicalEnvironment](#) is always restored to its former state.

### 14.12 The switch Statement

#### Syntax

```
SwitchStatement[Yield, Await, Return] :
```



```

switch ( Expression[+In, ?Yield, ?Await] ) CaseBlock[?Yield, ?Await, ?Return]

CaseBlock[Yield, Await, Return] :
  { CaseClauses[?Yield, ?Await, ?Return] opt }
  { CaseClauses[?Yield, ?Await, ?Return] opt
    DefaultClause[?Yield, ?Await, ?Return]
    CaseClauses[?Yield, ?Await, ?Return] opt }

CaseClauses[Yield, Await, Return] :
  CaseClause[?Yield, ?Await, ?Return]
  CaseClauses[?Yield, ?Await, ?Return] CaseClause[?Yield, ?Await, ?Return]

CaseClause[Yield, Await, Return] :
  case Expression[+In, ?Yield, ?Await] :
    StatementList[?Yield, ?Await, ?Return] opt

DefaultClause[Yield, Await, Return] :
  default : StatementList[?Yield, ?Await, ?Return] opt

```

### 14.12.1 Static Semantics: Early Errors

*SwitchStatement*: **switch** ( *Expression* ) *CaseBlock*

- It is a Syntax Error if the [LexicallyDeclaredNames](#) of *CaseBlock* contains any duplicate entries.
- It is a Syntax Error if any element of the [LexicallyDeclaredNames](#) of *CaseBlock* also occurs in the [VarDeclaredNames](#) of *CaseBlock*.

### 14.12.2 Runtime Semantics: CaseBlockEvaluation

The [syntax-directed operation](#) *CaseBlockEvaluation* takes argument *input* (an [ECMAScript language value](#)) and returns either a [normal completion containing an ECMAScript language value](#) or an [abrupt completion](#). It is defined piecewise over the following productions:

*CaseBlock* : { }

1. Return **undefined**.

*CaseBlock* : { *CaseClauses* }

1. Let *V* be **undefined**.
2. Let *A* be the [List](#) of *CaseClause* items in *CaseClauses*, in source text order.
3. Let *found* be **false**.
4. For each *CaseClause* *C* of *A*, do
  - a. If *found* is **false**, then
    - i. Set *found* to ? [CaseClausesSelected](#)(*C*, *input*).
  - b. If *found* is **true**, then
    - i. Let *R* be [Completion](#)([Evaluation](#) of *C*).
    - ii. If *R*.[[Value]] is not empty, set *V* to *R*.[[Value]].
    - iii. If *R* is an [abrupt completion](#), return ? [UpdateEmpty](#)(*R*, *V*).
5. Return *V*.

*CaseBlock* : { *CaseClauses*<sub>opt</sub> *DefaultClause* *CaseClauses*<sub>opt</sub> }

1. Let *V* be **undefined**.
2. If the first *CaseClauses* is present, then
  - a. Let *A* be the **List** of *CaseClause* items in the first *CaseClauses*, in source text order.
3. Else,
  - a. Let *A* be a new empty **List**.
4. Let *found* be **false**.
5. For each *CaseClause* *C* of *A*, do
  - a. If *found* is **false**, then
    - i. Set *found* to ? **CaseClausesSelected**(*C*, *input*).
  - b. If *found* is **true**, then
    - i. Let *R* be **Completion**(**Evaluation** of *C*).
    - ii. If *R*.[[Value]] is not empty, set *V* to *R*.[[Value]].
    - iii. If *R* is an **abrupt completion**, return ? **UpdateEmpty**(*R*, *V*).
6. Let *foundInB* be **false**.
7. If the second *CaseClauses* is present, then
  - a. Let *B* be the **List** of *CaseClause* items in the second *CaseClauses*, in source text order.
8. Else,
  - a. Let *B* be a new empty **List**.
9. If *found* is **false**, then
  - a. For each *CaseClause* *C* of *B*, do
    - i. If *foundInB* is **false**, then
      1. Set *foundInB* to ? **CaseClausesSelected**(*C*, *input*).
    - ii. If *foundInB* is **true**, then
      1. Let *R* be **Completion**(**Evaluation** of *CaseClause* *C*).
      2. If *R*.[[Value]] is not empty, set *V* to *R*.[[Value]].
      3. If *R* is an **abrupt completion**, return ? **UpdateEmpty**(*R*, *V*).
10. If *foundInB* is **true**, return *V*.
11. Let *R* be **Completion**(**Evaluation** of *DefaultClause*).
12. If *R*.[[Value]] is not empty, set *V* to *R*.[[Value]].
13. If *R* is an **abrupt completion**, return ? **UpdateEmpty**(*R*, *V*).
14. NOTE: The following is another complete iteration of the second *CaseClauses*.
15. For each *CaseClause* *C* of *B*, do
  - a. Let *R* be **Completion**(**Evaluation** of *CaseClause* *C*).
  - b. If *R*.[[Value]] is not empty, set *V* to *R*.[[Value]].
  - c. If *R* is an **abrupt completion**, return ? **UpdateEmpty**(*R*, *V*).
16. Return *V*.

### 14.12.3 CaseClausesSelected ( *C*, *input* )

The abstract operation **CaseClausesSelected** takes arguments *C* (a *CaseClause Parse Node*) and *input* (an **ECMAScript language value**) and returns either a **normal completion containing** a Boolean or an **abrupt completion**. It determines whether *C* matches *input*. It performs the following steps when called:

1. **Assert**: *C* is an instance of the production *CaseClause* : **case** *Expression* : *StatementList*<sub>opt</sub> .
2. Let *exprRef* be ? **Evaluation** of the *Expression* of *C*.
3. Let *clauseSelector* be ? **GetValue**(*exprRef*).
4. Return **IsStrictlyEqual**(*input*, *clauseSelector*).

**NOTE** This operation does not execute *C*'s *StatementList* (if any). The *CaseBlock* algorithm uses its return value to determine which *StatementList* to start executing.

## 14.12.4 Runtime Semantics: Evaluation

*SwitchStatement* : **switch** ( *Expression* ) *CaseBlock*

1. Let *exprRef* be ? *Evaluation* of *Expression*.
2. Let *switchValue* be ? *GetValue*(*exprRef*).
3. Let *oldEnv* be the *running execution context*'s *LexicalEnvironment*.
4. Let *blockEnv* be *NewDeclarativeEnvironment*(*oldEnv*).
5. Perform *BlockDeclarationInstantiation*(*CaseBlock*, *blockEnv*).
6. Set the *running execution context*'s *LexicalEnvironment* to *blockEnv*.
7. Let *R* be *Completion*(*CaseBlockEvaluation* of *CaseBlock* with argument *switchValue*).
8. Set the *running execution context*'s *LexicalEnvironment* to *oldEnv*.
9. Return *R*.

**NOTE** No matter how control leaves the *SwitchStatement* the *LexicalEnvironment* is always restored to its former state.

*CaseClause* : **case** *Expression* :

1. Return empty.

*CaseClause* : **case** *Expression* : *StatementList*

1. Return ? *Evaluation* of *StatementList*.

*DefaultClause* : **default** :

1. Return empty.

*DefaultClause* : **default** : *StatementList*

1. Return ? *Evaluation* of *StatementList*.

## 14.13 Labelled Statements

### Syntax

*LabelledStatement*<sub>[Yield, Await, Return]</sub> :  
*LabelIdentifier*<sub>[?Yield, ?Await]</sub> : *LabelledItem*<sub>[?Yield, ?Await, ?Return]</sub>

*LabelledItem*<sub>[Yield, Await, Return]</sub> :  
*Statement*<sub>[?Yield, ?Await, ?Return]</sub>  
*FunctionDeclaration*<sub>[?Yield, ?Await, ~Default]</sub>

**NOTE** A *Statement* may be prefixed by a label. Labelled statements are only used in conjunction with labelled **break** and **continue** statements. ECMAScript has no **goto** statement. A *Statement* can be part of a *LabelledStatement*, which itself can be part of a *LabelledStatement*, and so on. The labels introduced this way are collectively referred to as the “current label set” when describing the semantics of individual statements.

### 14.13.1 Static Semantics: Early Errors

*LabelledItem* : *FunctionDeclaration*

- It is a Syntax Error if any source text is matched by this production.

NOTE An alternative definition for this rule is provided in B.3.1.

### 14.13.2 Static Semantics: IsLabelledFunction ( *stmt* )

The abstract operation IsLabelledFunction takes argument *stmt* (a *Statement Parse Node*) and returns a Boolean. It performs the following steps when called:

1. If *stmt* is not a *LabelledStatement*, return **false**.
2. Let *item* be the *LabelledItem* of *stmt*.
3. If *item* is *LabelledItem* : *FunctionDeclaration* , return **true**.
4. Let *subStmt* be the *Statement* of *item*.
5. Return IsLabelledFunction(*subStmt*).

### 14.13.3 Runtime Semantics: Evaluation

*LabelledStatement* : *LabelIdentifier* : *LabelledItem*

1. Return ? *LabelledEvaluation* of this *LabelledStatement* with argument « ».

### 14.13.4 Runtime Semantics: LabelledEvaluation

The *syntax-directed operation* LabelledEvaluation takes argument *labelSet* (a *List of Strings*) and returns either a *normal completion containing an ECMAScript language value* or an *abrupt completion*. It is defined piecewise over the following productions:

*BreakableStatement* : *IterationStatement*

1. Let *stmtResult* be *Completion*(*LoopEvaluation* of *IterationStatement* with argument *labelSet*).
2. If *stmtResult*.[[Type]] is break, then
  - a. If *stmtResult*.[[Target]] is empty, then
    - i. If *stmtResult*.[[Value]] is empty, set *stmtResult* to *NormalCompletion*(**undefined**).
    - ii. Else, set *stmtResult* to *NormalCompletion*(*stmtResult*.[[Value]]).
3. Return ? *stmtResult*.

*BreakableStatement* : *SwitchStatement*

1. Let *stmtResult* be *Completion*(*Evaluation* of *SwitchStatement*).
2. If *stmtResult*.[[Type]] is break, then
  - a. If *stmtResult*.[[Target]] is empty, then
    - i. If *stmtResult*.[[Value]] is empty, set *stmtResult* to *NormalCompletion*(**undefined**).
    - ii. Else, set *stmtResult* to *NormalCompletion*(*stmtResult*.[[Value]]).
3. Return ? *stmtResult*.

NOTE 1 A *BreakableStatement* is one that can be exited via an unlabelled *BreakStatement*.

*LabelledStatement* : *LabelIdentifier* : *LabelledItem*

1. Let *label* be the *StringValue* of *LabelIdentifier*.
2. Let *newLabelSet* be the *list-concatenation* of *labelSet* and « *label* ».

3. Let *stmtResult* be `Completion(LabelledEvaluation of LabelledItem` with argument *newLabelSet*).
4. If *stmtResult*.[[Type]] is `break` and `SameValue(stmtResult.[[Target]], label)` is `true`, then
  - a. Set *stmtResult* to `NormalCompletion(stmtResult.[[Value]])`.
5. Return ? *stmtResult*.

*LabelledItem* : *FunctionDeclaration*

1. Return ? `Evaluation` of *FunctionDeclaration*.

*Statement* :

*BlockStatement*  
*VariableStatement*  
*EmptyStatement*  
*ExpressionStatement*  
*IfStatement*  
*ContinueStatement*  
*BreakStatement*  
*ReturnStatement*  
*WithStatement*  
*ThrowStatement*  
*TryStatement*  
*DebuggerStatement*

1. Return ? `Evaluation` of *Statement*.

NOTE 2 The only two productions of *Statement* which have special semantics for `LabelledEvaluation` are *BreakableStatement* and *LabelledStatement*.

## 14.14 The throw Statement

### Syntax

```
ThrowStatement[Yield, Await] :
    throw [no LineTerminator here] Expression[+In, ?Yield, ?Await] ;
```

### 14.14.1 Runtime Semantics: Evaluation

*ThrowStatement* : **throw** *Expression* ;

1. Let *exprRef* be ? `Evaluation` of *Expression*.
2. Let *exprValue* be ? `GetValue(exprRef)`.
3. Return `ThrowCompletion(exprValue)`.

## 14.15 The try Statement

### Syntax

```
TryStatement[Yield, Await, Return] :
    try Block[?Yield, ?Await, ?Return] Catch[?Yield, ?Await, ?Return]
    try Block[?Yield, ?Await, ?Return] Finally[?Yield, ?Await, ?Return]
```

```

try Block[?Yield, ?Await, ?Return] Catch[?Yield, ?Await, ?Return]
    Finally[?Yield, ?Await, ?Return]

```

```

Catch[Yield, Await, Return] :
  catch ( CatchParameter[?Yield, ?Await] ) Block[?Yield, ?Await, ?Return]
  catch Block[?Yield, ?Await, ?Return]

```

```

Finally[Yield, Await, Return] :
  finally Block[?Yield, ?Await, ?Return]

```

```

CatchParameter[Yield, Await] :
  BindingIdentifier[?Yield, ?Await]
  BindingPattern[?Yield, ?Await]

```

**NOTE** The **try** statement encloses a block of code in which an exceptional condition can occur, such as a runtime error or a **throw** statement. The **catch** clause provides the exception-handling code. When a catch clause catches an exception, its *CatchParameter* is bound to that exception.

### 14.15.1 Static Semantics: Early Errors

*Catch* : **catch** ( *CatchParameter* ) *Block*

- It is a Syntax Error if [BoundNames](#) of *CatchParameter* contains any duplicate elements.
- It is a Syntax Error if any element of the [BoundNames](#) of *CatchParameter* also occurs in the [LexicallyDeclaredNames](#) of *Block*.
- It is a Syntax Error if any element of the [BoundNames](#) of *CatchParameter* also occurs in the [VarDeclaredNames](#) of *Block*.

**NOTE** An alternative [static semantics](#) for this production is given in [B.3.4](#).

### 14.15.2 Runtime Semantics: CatchClauseEvaluation

The [syntax-directed operation](#) *CatchClauseEvaluation* takes argument *thrownValue* (an [ECMAScript language value](#)) and returns either a [normal completion containing an ECMAScript language value](#) or an [abrupt completion](#). It is defined piecewise over the following productions:

*Catch* : **catch** ( *CatchParameter* ) *Block*

1. Let *oldEnv* be the [running execution context](#)'s [LexicalEnvironment](#).
2. Let *catchEnv* be [NewDeclarativeEnvironment](#)(*oldEnv*).
3. For each element *argName* of the [BoundNames](#) of *CatchParameter*, do
  - a. Perform ! [catchEnv](#).[CreateMutableBinding](#)(*argName*, **false**).
4. Set the [running execution context](#)'s [LexicalEnvironment](#) to *catchEnv*.
5. Let *status* be [Completion](#)([BindingInitialization](#) of *CatchParameter* with arguments *thrownValue* and *catchEnv*).
6. If *status* is an [abrupt completion](#), then
  - a. Set the [running execution context](#)'s [LexicalEnvironment](#) to *oldEnv*.
  - b. Return ? *status*.
7. Let *B* be [Completion](#)([Evaluation](#) of *Block*).

8. Set the [running execution context](#)'s `LexicalEnvironment` to *oldEnv*.
9. Return ? *B*.

*Catch* : **catch** *Block*

1. Return ? [Evaluation](#) of *Block*.

**NOTE** No matter how control leaves the *Block* the `LexicalEnvironment` is always restored to its former state.

### 14.15.3 Runtime Semantics: Evaluation

*TryStatement* : **try** *Block* *Catch*

1. Let *B* be [Completion](#)([Evaluation](#) of *Block*).
2. If *B*.[`Type`] is `throw`, let *C* be [Completion](#)([CatchClauseEvaluation](#) of *Catch* with argument *B*.[`Value`]).
3. Else, let *C* be *B*.
4. Return ? [UpdateEmpty](#)(*C*, `undefined`).

*TryStatement* : **try** *Block* *Finally*

1. Let *B* be [Completion](#)([Evaluation](#) of *Block*).
2. Let *F* be [Completion](#)([Evaluation](#) of *Finally*).
3. If *F*.[`Type`] is `normal`, set *F* to *B*.
4. Return ? [UpdateEmpty](#)(*F*, `undefined`).

*TryStatement* : **try** *Block* *Catch* *Finally*

1. Let *B* be [Completion](#)([Evaluation](#) of *Block*).
2. If *B*.[`Type`] is `throw`, let *C* be [Completion](#)([CatchClauseEvaluation](#) of *Catch* with argument *B*.[`Value`]).
3. Else, let *C* be *B*.
4. Let *F* be [Completion](#)([Evaluation](#) of *Finally*).
5. If *F*.[`Type`] is `normal`, set *F* to *C*.
6. Return ? [UpdateEmpty](#)(*F*, `undefined`).

## 14.16 The debugger Statement

### Syntax

*DebuggerStatement* :  
**debugger** ;

#### 14.16.1 Runtime Semantics: Evaluation

**NOTE** Evaluating a *DebuggerStatement* may allow an implementation to cause a breakpoint when run under a debugger. If a debugger is not present or active this statement has no observable effect.

*DebuggerStatement* : **debugger** ;

1. If an [implementation-defined](#) debugging facility is available and enabled, then
  - a. Perform an [implementation-defined](#) debugging action.
  - b. Return a new [implementation-defined Completion Record](#).
2. Else,
  - a. Return empty.

## 15 ECMAScript Language: Functions and Classes

**NOTE** Various ECMAScript language elements cause the creation of ECMAScript [function objects](#) (10.2). [Evaluation](#) of such functions starts with the execution of their `[[Call]]` internal method (10.2.1).

### 15.1 Parameter Lists

#### Syntax

*UniqueFormalParameters*<sub>[Yield, Await]</sub> :  
*FormalParameters*<sub>[?Yield, ?Await]</sub>

*FormalParameters*<sub>[Yield, Await]</sub> :  
 [empty]  
*FunctionRestParameter*<sub>[?Yield, ?Await]</sub>  
*FormalParameterList*<sub>[?Yield, ?Await]</sub>  
*FormalParameterList*<sub>[?Yield, ?Await]</sub> ,  
*FormalParameterList*<sub>[?Yield, ?Await]</sub> , *FunctionRestParameter*<sub>[?Yield, ?Await]</sub>

*FormalParameterList*<sub>[Yield, Await]</sub> :  
*FormalParameter*<sub>[?Yield, ?Await]</sub>  
*FormalParameterList*<sub>[?Yield, ?Await]</sub> , *FormalParameter*<sub>[?Yield, ?Await]</sub>

*FunctionRestParameter*<sub>[Yield, Await]</sub> :  
*BindingRestElement*<sub>[?Yield, ?Await]</sub>

*FormalParameter*<sub>[Yield, Await]</sub> :  
*BindingElement*<sub>[?Yield, ?Await]</sub>

#### 15.1.1 Static Semantics: Early Errors

*UniqueFormalParameters* : *FormalParameters*

- It is a Syntax Error if [BoundNames](#) of *FormalParameters* contains any duplicate elements.

*FormalParameters* : *FormalParameterList*

- It is a Syntax Error if [IsSimpleParameterList](#) of *FormalParameterList* is **false** and [BoundNames](#) of *FormalParameterList* contains any duplicate elements.

**NOTE** Multiple occurrences of the same *BindingIdentifier* in a *FormalParameterList* is only allowed for functions which have simple parameter lists and which are not defined in [strict mode code](#).

#### 15.1.2 Static Semantics: ContainsExpression

The [syntax-directed operation](#) `ContainsExpression` takes no arguments and returns a Boolean. It is defined piecewise over the following productions:



*ObjectBindingPattern* :

```
{ }  
{ BindingRestProperty }
```

1. Return **false**.

*ObjectBindingPattern* : { *BindingPropertyList* , *BindingRestProperty* }

1. Return *ContainsExpression* of *BindingPropertyList*.

*ArrayBindingPattern* : [ *Elision*<sub>opt</sub> ]

1. Return **false**.

*ArrayBindingPattern* : [ *Elision*<sub>opt</sub> *BindingRestElement* ]

1. Return *ContainsExpression* of *BindingRestElement*.

*ArrayBindingPattern* : [ *BindingElementList* , *Elision*<sub>opt</sub> ]

1. Return *ContainsExpression* of *BindingElementList*.

*ArrayBindingPattern* : [ *BindingElementList* , *Elision*<sub>opt</sub> *BindingRestElement* ]

1. Let *has* be *ContainsExpression* of *BindingElementList*.
2. If *has* is **true**, return **true**.
3. Return *ContainsExpression* of *BindingRestElement*.

*BindingPropertyList* : *BindingPropertyList* , *BindingProperty*

1. Let *has* be *ContainsExpression* of *BindingPropertyList*.
2. If *has* is **true**, return **true**.
3. Return *ContainsExpression* of *BindingProperty*.

*BindingElementList* : *BindingElementList* , *BindingElisionElement*

1. Let *has* be *ContainsExpression* of *BindingElementList*.
2. If *has* is **true**, return **true**.
3. Return *ContainsExpression* of *BindingElisionElement*.

*BindingElisionElement* : *Elision*<sub>opt</sub> *BindingElement*

1. Return *ContainsExpression* of *BindingElement*.

*BindingProperty* : *PropertyName* : *BindingElement*

1. Let *has* be *IsComputedPropertyKey* of *PropertyName*.
2. If *has* is **true**, return **true**.
3. Return *ContainsExpression* of *BindingElement*.

*BindingElement* : *BindingPattern* *Initializer*

1. Return **true**.

*SingleNameBinding* : *BindingIdentifier*

1. Return **false**.

*SingleNameBinding* : *BindingIdentifier* *Initializer*

1. Return **true**.

*BindingRestElement* : . . . *BindingIdentifier*

1. Return **false**.

*BindingRestElement* : . . . *BindingPattern*

1. Return [ContainsExpression](#) of *BindingPattern*.

*FormalParameters* : [empty]

1. Return **false**.

*FormalParameters* : *FormalParameterList* , *FunctionRestParameter*

1. If [ContainsExpression](#) of *FormalParameterList* is **true**, return **true**.
2. Return [ContainsExpression](#) of *FunctionRestParameter*.

*FormalParameterList* : *FormalParameterList* , *FormalParameter*

1. If [ContainsExpression](#) of *FormalParameterList* is **true**, return **true**.
2. Return [ContainsExpression](#) of *FormalParameter*.

*ArrowParameters* : *BindingIdentifier*

1. Return **false**.

*ArrowParameters* : *CoverParenthesizedExpressionAndArrowParameterList*

1. Let *formals* be the *ArrowFormalParameters* that is [covered](#) by *CoverParenthesizedExpressionAndArrowParameterList*.
2. Return [ContainsExpression](#) of *formals*.

*AsyncArrowBindingIdentifier* : *BindingIdentifier*

1. Return **false**.

### 15.1.3 Static Semantics: **IsSimpleParameterList**

The [syntax-directed operation](#) `IsSimpleParameterList` takes no arguments and returns a Boolean. It is defined piecewise over the following productions:

*BindingElement* : *BindingPattern*

1. Return **false**.

*BindingElement* : *BindingPattern* *Initializer*

1. Return **false**.

*SingleNameBinding* : *BindingIdentifier*

1. Return **true**.

*SingleNameBinding* : *BindingIdentifier* *Initializer*

1. Return **false**.

*FormalParameters* : [empty]

1. Return **true**.

*FormalParameters* : *FunctionRestParameter*

1. Return **false**.

*FormalParameters* : *FormalParameterList* , *FunctionRestParameter*

1. Return **false**.

*FormalParameterList* : *FormalParameterList* , *FormalParameter*

1. If *IsSimpleParameterList* of *FormalParameterList* is **false**, return **false**.
2. Return *IsSimpleParameterList* of *FormalParameter*.

*FormalParameter* : *BindingElement*

1. Return *IsSimpleParameterList* of *BindingElement*.

*ArrowParameters* : *BindingIdentifier*

1. Return **true**.

*ArrowParameters* : *CoverParenthesizedExpressionAndArrowParameterList*

1. Let *formals* be the *ArrowFormalParameters* that is *covered* by *CoverParenthesizedExpressionAndArrowParameterList*.
2. Return *IsSimpleParameterList* of *formals*.

*AsyncArrowBindingIdentifier* : *BindingIdentifier*

1. Return **true**.

*CoverCallExpressionAndAsyncArrowHead* : *MemberExpression Arguments*

1. Let *head* be the *AsyncArrowHead* that is *covered* by *CoverCallExpressionAndAsyncArrowHead*.
2. Return *IsSimpleParameterList* of *head*.

#### 15.1.4 Static Semantics: HasInitializer

The *syntax-directed operation* *HasInitializer* takes no arguments and returns a Boolean. It is defined piecewise over the following productions:

*BindingElement* : *BindingPattern*

1. Return **false**.

*BindingElement* : *BindingPattern Initializer*

1. Return **true**.

*SingleNameBinding* : *BindingIdentifier*

1. Return **false**.

*SingleNameBinding* : *BindingIdentifier Initializer*

1. Return **true**.

*FormalParameterList* : *FormalParameterList* , *FormalParameter*

1. If `HasInitializer` of *FormalParameterList* is **true**, return **true**.
2. Return `HasInitializer` of *FormalParameter*.

### 15.1.5 Static Semantics: `ExpectedArgumentCount`

The [syntax-directed operation](#) `ExpectedArgumentCount` takes no arguments and returns an [integer](#). It is defined piecewise over the following productions:

*FormalParameters* :

[empty]

*FunctionRestParameter*

1. Return 0.

*FormalParameters* : *FormalParameterList* , *FunctionRestParameter*

1. Return `ExpectedArgumentCount` of *FormalParameterList*.

**NOTE** The `ExpectedArgumentCount` of a *FormalParameterList* is the number of *FormalParameters* to the left of either the rest parameter or the first *FormalParameter* with an `Initializer`. A *FormalParameter* without an `initializer` is allowed after the first parameter with an `initializer` but such parameters are considered to be optional with **undefined** as their default value.

*FormalParameterList* : *FormalParameter*

1. If `HasInitializer` of *FormalParameter* is **true**, return 0.
2. Return 1.

*FormalParameterList* : *FormalParameterList* , *FormalParameter*

1. Let *count* be `ExpectedArgumentCount` of *FormalParameterList*.
2. If `HasInitializer` of *FormalParameterList* is **true** or `HasInitializer` of *FormalParameter* is **true**, return *count*.
3. Return *count* + 1.

*ArrowParameters* : *BindingIdentifier*

1. Return 1.

*ArrowParameters* : *CoverParenthesizedExpressionAndArrowParameterList*

1. Let *formals* be the *ArrowFormalParameters* that is [covered](#) by *CoverParenthesizedExpressionAndArrowParameterList*.
2. Return `ExpectedArgumentCount` of *formals*.

*PropertySetParameterList* : *FormalParameter*

1. If `HasInitializer` of *FormalParameter* is **true**, return 0.
2. Return 1.

*AsyncArrowBindingIdentifier* : *BindingIdentifier*

1. Return 1.

## 15.2 Function Definitions

### Syntax

```

FunctionDeclaration[Yield, Await, Default] :
    function BindingIdentifier[?Yield, ?Await] ( FormalParameters[~Yield, ~Await] )
        { FunctionBody[~Yield, ~Await] }
[+Default] function ( FormalParameters[~Yield, ~Await] ) {
    FunctionBody[~Yield, ~Await] }

FunctionExpression :
    function BindingIdentifier[~Yield, ~Await] opt ( FormalParameters[~Yield, ~Await]
        ) { FunctionBody[~Yield, ~Await] }

FunctionBody[Yield, Await] :
    FunctionStatementList[?Yield, ?Await]

FunctionStatementList[Yield, Await] :
    StatementList[?Yield, ?Await, +Return] opt

```

### 15.2.1 Static Semantics: Early Errors

```

FunctionDeclaration :
    function BindingIdentifier ( FormalParameters ) { FunctionBody }
    function ( FormalParameters ) { FunctionBody }

FunctionExpression :
    function BindingIdentifieropt ( FormalParameters ) { FunctionBody }

```

- If the [source text matched by FormalParameters](#) is [strict mode code](#), the Early Error rules for [UniqueFormalParameters : FormalParameters](#) are applied.
- If [BindingIdentifier](#) is present and the [source text matched by BindingIdentifier](#) is [strict mode code](#), it is a Syntax Error if the [StringValue](#) of [BindingIdentifier](#) is either **"eval"** or **"arguments"**.
- It is a Syntax Error if [FunctionBodyContainsUseStrict](#) of [FunctionBody](#) is **true** and [IsSimpleParameterList](#) of [FormalParameters](#) is **false**.
- It is a Syntax Error if any element of the [BoundNames](#) of [FormalParameters](#) also occurs in the [LexicallyDeclaredNames](#) of [FunctionBody](#).
- It is a Syntax Error if [FormalParameters Contains SuperProperty](#) is **true**.
- It is a Syntax Error if [FunctionBody Contains SuperProperty](#) is **true**.
- It is a Syntax Error if [FormalParameters Contains SuperCall](#) is **true**.
- It is a Syntax Error if [FunctionBody Contains SuperCall](#) is **true**.

**NOTE** The [LexicallyDeclaredNames](#) of a [FunctionBody](#) does not include identifiers bound using `var` or function declarations.

*FunctionBody* : *FunctionStatementList*

- It is a Syntax Error if the [LexicallyDeclaredNames](#) of [FunctionStatementList](#) contains any duplicate entries.
- It is a Syntax Error if any element of the [LexicallyDeclaredNames](#) of [FunctionStatementList](#) also occurs in the [VarDeclaredNames](#) of [FunctionStatementList](#).
- It is a Syntax Error if [ContainsDuplicateLabels](#) of [FunctionStatementList](#) with argument `« »` is **true**.
- It is a Syntax Error if [ContainsUndefinedBreakTarget](#) of [FunctionStatementList](#) with argument `« »` is **true**.
- It is a Syntax Error if [ContainsUndefinedContinueTarget](#) of [FunctionStatementList](#) with arguments `« »` and `« »` is **true**.

## 15.2.2 Static Semantics: FunctionBodyContainsUseStrict

The [syntax-directed operation](#) `FunctionBodyContainsUseStrict` takes no arguments and returns a Boolean. It is defined piecewise over the following productions:

*FunctionBody* : *FunctionStatementList*

1. If the [Directive Prologue](#) of *FunctionBody* contains a [Use Strict Directive](#), return **true**; otherwise, return **false**.

## 15.2.3 Runtime Semantics: EvaluateFunctionBody

The [syntax-directed operation](#) `EvaluateFunctionBody` takes arguments *functionObject* (a [function object](#)) and *argumentsList* (a [List of ECMAScript language values](#)) and returns either a [normal completion containing an ECMAScript language value](#) or an [abrupt completion](#). It is defined piecewise over the following productions:

*FunctionBody* : *FunctionStatementList*

1. Perform ? [FunctionDeclarationInstantiation](#)(*functionObject*, *argumentsList*).
2. Return ? [Evaluation](#) of *FunctionStatementList*.

## 15.2.4 Runtime Semantics: InstantiateOrdinaryFunctionObject

The [syntax-directed operation](#) `InstantiateOrdinaryFunctionObject` takes arguments *env* (an [Environment Record](#)) and *privateEnv* (a [PrivateEnvironment Record](#) or **null**) and returns a [function object](#). It is defined piecewise over the following productions:

*FunctionDeclaration* : **function** *BindingIdentifier* ( *FormalParameters* ) { *FunctionBody* }

1. Let *name* be [StringValue](#) of *BindingIdentifier*.
2. Let *sourceText* be the [source text matched by FunctionDeclaration](#).
3. Let *F* be [OrdinaryFunctionCreate](#)(%[Function.prototype](#)%, *sourceText*, *FormalParameters*, *FunctionBody*, non-lexical-this, *env*, *privateEnv*).
4. Perform [SetFunctionName](#)(*F*, *name*).
5. Perform [MakeConstructor](#)(*F*).
6. Return *F*.

*FunctionDeclaration* : **function** ( *FormalParameters* ) { *FunctionBody* }

1. Let *sourceText* be the [source text matched by FunctionDeclaration](#).
2. Let *F* be [OrdinaryFunctionCreate](#)(%[Function.prototype](#)%, *sourceText*, *FormalParameters*, *FunctionBody*, non-lexical-this, *env*, *privateEnv*).
3. Perform [SetFunctionName](#)(*F*, "default").
4. Perform [MakeConstructor](#)(*F*).
5. Return *F*.

**NOTE** An anonymous *FunctionDeclaration* can only occur as part of an **export default** declaration, and its function code is therefore always [strict mode code](#).

## 15.2.5 Runtime Semantics: InstantiateOrdinaryFunctionExpression

The [syntax-directed operation](#) `InstantiateOrdinaryFunctionExpression` takes optional argument *name* (a [property key](#) or a [Private Name](#)) and returns a [function object](#). It is defined piecewise over the following productions:

*FunctionExpression* : **function** ( *FormalParameters* ) { *FunctionBody* }

1. If *name* is not present, set *name* to "".
2. Let *env* be the [LexicalEnvironment](#) of the [running execution context](#).
3. Let *privateEnv* be the [running execution context](#)'s [PrivateEnvironment](#).
4. Let *sourceText* be the [source text matched by FunctionExpression](#).
5. Let *closure* be [OrdinaryFunctionCreate](#)(%[Function.prototype](#)%, *sourceText*, *FormalParameters*, *FunctionBody*, non-lexical-this, *env*, *privateEnv*).
6. Perform [SetFunctionName](#)(*closure*, *name*).
7. Perform [MakeConstructor](#)(*closure*).
8. Return *closure*.

*FunctionExpression* : **function** *BindingIdentifier* ( *FormalParameters* ) { *FunctionBody* }

1. [Assert](#): *name* is not present.
2. Set *name* to [StringValue](#) of *BindingIdentifier*.
3. Let *outerEnv* be the [running execution context](#)'s [LexicalEnvironment](#).
4. Let *funcEnv* be [NewDeclarativeEnvironment](#)(*outerEnv*).
5. Perform ! *funcEnv*.[CreateImmutableBinding](#)(*name*, **false**).
6. Let *privateEnv* be the [running execution context](#)'s [PrivateEnvironment](#).
7. Let *sourceText* be the [source text matched by FunctionExpression](#).
8. Let *closure* be [OrdinaryFunctionCreate](#)(%[Function.prototype](#)%, *sourceText*, *FormalParameters*, *FunctionBody*, non-lexical-this, *funcEnv*, *privateEnv*).
9. Perform [SetFunctionName](#)(*closure*, *name*).
10. Perform [MakeConstructor](#)(*closure*).
11. Perform ! *funcEnv*.[InitializeBinding](#)(*name*, *closure*).
12. Return *closure*.

**NOTE** The *BindingIdentifier* in a *FunctionExpression* can be referenced from inside the *FunctionExpression*'s *FunctionBody* to allow the function to call itself recursively. However, unlike in a *FunctionDeclaration*, the *BindingIdentifier* in a *FunctionExpression* cannot be referenced from and does not affect the scope enclosing the *FunctionExpression*.

## 15.2.6 Runtime Semantics: Evaluation

*FunctionDeclaration* : **function** *BindingIdentifier* ( *FormalParameters* ) { *FunctionBody* }

1. Return empty.

**NOTE 1** An alternative semantics is provided in [B.3.2](#).

*FunctionDeclaration* : **function** ( *FormalParameters* ) { *FunctionBody* }

1. Return empty.

*FunctionExpression* : **function** *BindingIdentifier*<sub>opt</sub> ( *FormalParameters* ) { *FunctionBody* }

1. Return `InstantiateOrdinaryFunctionExpression` of `FunctionExpression`.

NOTE 2 A "**prototype**" property is automatically created for every function defined using a `FunctionDeclaration` or `FunctionExpression`, to allow for the possibility that the function will be used as a `constructor`.

`FunctionStatementList` : [empty]

1. Return **undefined**.

## 15.3 Arrow Function Definitions

### Syntax

`ArrowFunction`<sub>[In, Yield, Await]</sub> :  
`ArrowParameters`<sub>[?Yield, ?Await]</sub> [no `LineTerminator` here] => `ConciseBody`<sub>[?In]</sub>

`ArrowParameters`<sub>[Yield, Await]</sub> :  
`BindingIdentifier`<sub>[?Yield, ?Await]</sub>  
`CoverParenthesizedExpressionAndArrowParameterList`<sub>[?Yield, ?Await]</sub>

`ConciseBody`<sub>[In]</sub> :  
 [lookahead ≠ {] `ExpressionBody`<sub>[?In, ~Await]</sub>  
 { `FunctionBody`<sub>[~Yield, ~Await]</sub> }

`ExpressionBody`<sub>[In, Await]</sub> :  
`AssignmentExpression`<sub>[?In, ~Yield, ?Await]</sub>

### Supplemental Syntax

When processing an instance of the production

`ArrowParameters`<sub>[Yield, Await]</sub> :  
`CoverParenthesizedExpressionAndArrowParameterList`<sub>[?Yield, ?Await]</sub>

the interpretation of `CoverParenthesizedExpressionAndArrowParameterList` is refined using the following grammar:

`ArrowFormalParameters`<sub>[Yield, Await]</sub> :  
 ( `UniqueFormalParameters`<sub>[?Yield, ?Await]</sub> )

### 15.3.1 Static Semantics: Early Errors

`ArrowFunction` : `ArrowParameters` => `ConciseBody`

- It is a Syntax Error if `ArrowParameters` `Contains YieldExpression` is **true**.
- It is a Syntax Error if `ArrowParameters` `Contains AwaitExpression` is **true**.
- It is a Syntax Error if `ConciseBodyContainsUseStrict` of `ConciseBody` is **true** and `IsSimpleParameterList` of `ArrowParameters` is **false**.
- It is a Syntax Error if any element of the `BoundNames` of `ArrowParameters` also occurs in the `LexicallyDeclaredNames` of `ConciseBody`.

`ArrowParameters` : `CoverParenthesizedExpressionAndArrowParameterList`

- `CoverParenthesizedExpressionAndArrowParameterList` **must cover** an `ArrowFormalParameters`.



### 15.3.2 Static Semantics: ConciseBodyContainsUseStrict

The [syntax-directed operation](#) `ConciseBodyContainsUseStrict` takes no arguments and returns a Boolean. It is defined piecewise over the following productions:

*ConciseBody* : *ExpressionBody*

1. Return **false**.

*ConciseBody* : { *FunctionBody* }

1. Return `FunctionBodyContainsUseStrict` of *FunctionBody*.

### 15.3.3 Runtime Semantics: EvaluateConciseBody

The [syntax-directed operation](#) `EvaluateConciseBody` takes arguments *functionObject* (a [function object](#)) and *argumentsList* (a [List of ECMAScript language values](#)) and returns either a [normal completion containing an ECMAScript language value](#) or an [abrupt completion](#). It is defined piecewise over the following productions:

*ConciseBody* : *ExpressionBody*

1. Perform ? `FunctionDeclarationInstantiation`(*functionObject*, *argumentsList*).
2. Return ? `Evaluation` of *ExpressionBody*.

### 15.3.4 Runtime Semantics: InstantiateArrowFunctionExpression

The [syntax-directed operation](#) `InstantiateArrowFunctionExpression` takes optional argument *name* (a [property key](#) or a [Private Name](#)) and returns a [function object](#). It is defined piecewise over the following productions:

*ArrowFunction* : *ArrowParameters* => *ConciseBody*

1. If *name* is not present, set *name* to "".
2. Let *env* be the [LexicalEnvironment](#) of the [running execution context](#).
3. Let *privateEnv* be the [running execution context](#)'s [PrivateEnvironment](#).
4. Let *sourceText* be the [source text matched by ArrowFunction](#).
5. Let *closure* be `OrdinaryFunctionCreate`(%[Function.prototype](#)%, *sourceText*, *ArrowParameters*, *ConciseBody*, [lexical-this](#), *env*, *privateEnv*).
6. Perform `SetFunctionName`(*closure*, *name*).
7. Return *closure*.

**NOTE** An *ArrowFunction* does not define local bindings for **arguments**, **super**, **this**, or **new.target**. Any reference to **arguments**, **super**, **this**, or **new.target** within an *ArrowFunction* must resolve to a binding in a lexically enclosing environment. Typically this will be the [Function Environment](#) of an immediately enclosing function. Even though an *ArrowFunction* may contain references to **super**, the [function object](#) created in step 5 is not made into a method by performing `MakeMethod`. An *ArrowFunction* that references **super** is always contained within a non-*ArrowFunction* and the necessary state to implement **super** is accessible via the *env* that is captured by the [function object](#) of the *ArrowFunction*.

### 15.3.5 Runtime Semantics: Evaluation

*ArrowFunction* : *ArrowParameters* => *ConciseBody*

1. Return `InstantiateArrowFunctionExpression` of *ArrowFunction*.

*ExpressionBody* : *AssignmentExpression*

1. Let *exprRef* be ? [Evaluation](#) of *AssignmentExpression*.
2. Let *exprValue* be ? [GetValue](#)(*exprRef*).
3. Return [Completion Record](#) { [\[\[Type\]\]](#): return, [\[\[Value\]\]](#): *exprValue*, [\[\[Target\]\]](#): empty }.

## 15.4 Method Definitions

### Syntax

```

MethodDefinition[Yield, Await] :
  ClassElementName[?Yield, ?Await] ( UniqueFormalParameters[~Yield, ~Await] ) {
    FunctionBody[~Yield, ~Await] }
  GeneratorMethod[?Yield, ?Await]
  AsyncMethod[?Yield, ?Await]
  AsyncGeneratorMethod[?Yield, ?Await]
  get ClassElementName[?Yield, ?Await] ( ) { FunctionBody[~Yield, ~Await] }
  set ClassElementName[?Yield, ?Await] ( PropertySetParameterList ) {
    FunctionBody[~Yield, ~Await] }

PropertySetParameterList :
  FormalParameter[~Yield, ~Await]

```

### 15.4.1 Static Semantics: Early Errors

*MethodDefinition* : *ClassElementName* ( *UniqueFormalParameters* ) { *FunctionBody* }

- It is a Syntax Error if [FunctionBodyContainsUseStrict](#) of *FunctionBody* is **true** and [IsSimpleParameterList](#) of *UniqueFormalParameters* is **false**.
- It is a Syntax Error if any element of the [BoundNames](#) of *UniqueFormalParameters* also occurs in the [LexicallyDeclaredNames](#) of *FunctionBody*.

*MethodDefinition* : **set** *ClassElementName* ( *PropertySetParameterList* ) { *FunctionBody* }

- It is a Syntax Error if [BoundNames](#) of *PropertySetParameterList* contains any duplicate elements.
- It is a Syntax Error if [FunctionBodyContainsUseStrict](#) of *FunctionBody* is **true** and [IsSimpleParameterList](#) of *PropertySetParameterList* is **false**.
- It is a Syntax Error if any element of the [BoundNames](#) of *PropertySetParameterList* also occurs in the [LexicallyDeclaredNames](#) of *FunctionBody*.

### 15.4.2 Static Semantics: HasDirectSuper

The [syntax-directed operation](#) [HasDirectSuper](#) takes no arguments and returns a Boolean. It is defined piecewise over the following productions:

*MethodDefinition* : *ClassElementName* ( *UniqueFormalParameters* ) { *FunctionBody* }

1. If *UniqueFormalParameters* [Contains SuperCall](#) is **true**, return **true**.
2. Return *FunctionBody* [Contains SuperCall](#).

*MethodDefinition* : **get** *ClassElementName* ( ) { *FunctionBody* }

1. Return *FunctionBody* [Contains SuperCall](#).

*MethodDefinition* : **set** *ClassElementName* ( *PropertySetParameterList* ) { *FunctionBody* }

1. If *PropertySetParameterList* **Contains** *SuperCall* is **true**, return **true**.
2. Return *FunctionBody* **Contains** *SuperCall*.

*GeneratorMethod* : \* *ClassElementName* ( *UniqueFormalParameters* ) { *GeneratorBody* }

1. If *UniqueFormalParameters* **Contains** *SuperCall* is **true**, return **true**.
2. Return *GeneratorBody* **Contains** *SuperCall*.

*AsyncGeneratorMethod* : **async** \* *ClassElementName* ( *UniqueFormalParameters* ) { *AsyncGeneratorBody* }

1. If *UniqueFormalParameters* **Contains** *SuperCall* is **true**, return **true**.
2. Return *AsyncGeneratorBody* **Contains** *SuperCall*.

*AsyncMethod* : **async** *ClassElementName* ( *UniqueFormalParameters* ) { *AsyncFunctionBody* }

1. If *UniqueFormalParameters* **Contains** *SuperCall* is **true**, return **true**.
2. Return *AsyncFunctionBody* **Contains** *SuperCall*.

### 15.4.3 Static Semantics: SpecialMethod

The **syntax-directed operation** *SpecialMethod* takes no arguments and returns a Boolean. It is defined piecewise over the following productions:

*MethodDefinition* : *ClassElementName* ( *UniqueFormalParameters* ) { *FunctionBody* }

1. Return **false**.

*MethodDefinition* :

*GeneratorMethod*

*AsyncMethod*

*AsyncGeneratorMethod*

**get** *ClassElementName* ( ) { *FunctionBody* }

**set** *ClassElementName* ( *PropertySetParameterList* ) { *FunctionBody* }

1. Return **true**.

### 15.4.4 Runtime Semantics: DefineMethod

The **syntax-directed operation** *DefineMethod* takes argument *object* (an Object) and optional argument *functionPrototype* (an Object) and returns either a **normal completion containing a Record** with fields **[[Key]]** (a **property key**) and **[[Closure]]** (a **function object**) or an **abrupt completion**. It is defined piecewise over the following productions:

*MethodDefinition* : *ClassElementName* ( *UniqueFormalParameters* ) { *FunctionBody* }

1. Let *propKey* be ? **Evaluation** of *ClassElementName*.
2. Let *env* be the **running execution context**'s **LexicalEnvironment**.
3. Let *privateEnv* be the **running execution context**'s **PrivateEnvironment**.
4. If *functionPrototype* is present, then
  - a. Let *prototype* be *functionPrototype*.
5. Else,
  - a. Let *prototype* be %**Function.prototype**%.
6. Let *sourceText* be the **source text matched by MethodDefinition**.

7. Let *closure* be `OrdinaryFunctionCreate(prototype, sourceText, UniqueFormalParameters, FunctionBody, non-lexical-this, env, privateEnv)`.
8. Perform `MakeMethod(closure, object)`.
9. Return the `Record` { `[[Key]]: propKey`, `[[Closure]]: closure` }.

### 15.4.5 Runtime Semantics: MethodDefinitionEvaluation

The `syntax-directed operation` `MethodDefinitionEvaluation` takes arguments *object* (an `Object`) and *enumerable* (a `Boolean`) and returns either a `normal completion containing` either a `PrivateElement` or unused, or an `abrupt completion`. It is defined piecewise over the following productions:

*MethodDefinition* : *ClassElementName* ( *UniqueFormalParameters* ) { *FunctionBody* }

1. Let *methodDef* be ? `DefineMethod` of *MethodDefinition* with argument *object*.
2. Perform `SetFunctionName(methodDef.[[Closure]], methodDef.[[Key]])`.
3. Return `DefineMethodProperty(object, methodDef.[[Key]], methodDef.[[Closure]], enumerable)`.

*MethodDefinition* : **get** *ClassElementName* ( ) { *FunctionBody* }

1. Let *propKey* be ? `Evaluation` of *ClassElementName*.
2. Let *env* be the `running execution context`'s `LexicalEnvironment`.
3. Let *privateEnv* be the `running execution context`'s `PrivateEnvironment`.
4. Let *sourceText* be the `source text matched by MethodDefinition`.
5. Let *formalParameterList* be an instance of the production `FormalParameters` : [empty] .
6. Let *closure* be `OrdinaryFunctionCreate(%Function.prototype%, sourceText, formalParameterList, FunctionBody, non-lexical-this, env, privateEnv)`.
7. Perform `MakeMethod(closure, object)`.
8. Perform `SetFunctionName(closure, propKey, "get")`.
9. If *propKey* is a `Private Name`, then
  - a. Return `PrivateElement` { `[[Key]]: propKey`, `[[Kind]]: accessor`, `[[Get]]: closure`, `[[Set]]: undefined` }.
10. Else,
  - a. Let *desc* be the `PropertyDescriptor` { `[[Get]]: closure`, `[[Enumerable]]: enumerable`, `[[Configurable]]: true` }.
  - b. Perform ? `DefinePropertyOrThrow(object, propKey, desc)`.
  - c. Return unused.

*MethodDefinition* : **set** *ClassElementName* ( *PropertySetParameterList* ) { *FunctionBody* }

1. Let *propKey* be ? `Evaluation` of *ClassElementName*.
2. Let *env* be the `running execution context`'s `LexicalEnvironment`.
3. Let *privateEnv* be the `running execution context`'s `PrivateEnvironment`.
4. Let *sourceText* be the `source text matched by MethodDefinition`.
5. Let *closure* be `OrdinaryFunctionCreate(%Function.prototype%, sourceText, PropertySetParameterList, FunctionBody, non-lexical-this, env, privateEnv)`.
6. Perform `MakeMethod(closure, object)`.
7. Perform `SetFunctionName(closure, propKey, "set")`.
8. If *propKey* is a `Private Name`, then
  - a. Return `PrivateElement` { `[[Key]]: propKey`, `[[Kind]]: accessor`, `[[Get]]: undefined`, `[[Set]]: closure` }.
9. Else,
  - a. Let *desc* be the `PropertyDescriptor` { `[[Set]]: closure`, `[[Enumerable]]: enumerable`, `[[Configurable]]: true` }.
  - b. Perform ? `DefinePropertyOrThrow(object, propKey, desc)`.

c. Return unused.

*GeneratorMethod* : \* *ClassElementName* ( *UniqueFormalParameters* ) { *GeneratorBody* }

1. Let *propKey* be ? *Evaluation* of *ClassElementName*.
2. Let *env* be the *running execution context*'s *LexicalEnvironment*.
3. Let *privateEnv* be the *running execution context*'s *PrivateEnvironment*.
4. Let *sourceText* be the *source text* matched by *GeneratorMethod*.
5. Let *closure* be *OrdinaryFunctionCreate*(%*GeneratorFunction.prototype*%, *sourceText*, *UniqueFormalParameters*, *GeneratorBody*, non-lexical-this, *env*, *privateEnv*).
6. Perform *MakeMethod*(*closure*, *object*).
7. Perform *SetFunctionName*(*closure*, *propKey*).
8. Let *prototype* be *OrdinaryObjectCreate*(%*GeneratorFunction.prototype.prototype*%).
9. Perform ! *DefinePropertyOrThrow*(*closure*, "prototype", *PropertyDescriptor* { *[[Value]]*: *prototype*, *[[Writable]]*: true, *[[Enumerable]]*: false, *[[Configurable]]*: false }).
10. Return *DefineMethodProperty*(*object*, *propKey*, *closure*, *enumerable*).

*AsyncGeneratorMethod* : **async** \* *ClassElementName* ( *UniqueFormalParameters* ) { *AsyncGeneratorBody* }

1. Let *propKey* be ? *Evaluation* of *ClassElementName*.
2. Let *env* be the *running execution context*'s *LexicalEnvironment*.
3. Let *privateEnv* be the *running execution context*'s *PrivateEnvironment*.
4. Let *sourceText* be the *source text* matched by *AsyncGeneratorMethod*.
5. Let *closure* be *OrdinaryFunctionCreate*(%*AsyncGeneratorFunction.prototype*%, *sourceText*, *UniqueFormalParameters*, *AsyncGeneratorBody*, non-lexical-this, *env*, *privateEnv*).
6. Perform *MakeMethod*(*closure*, *object*).
7. Perform *SetFunctionName*(*closure*, *propKey*).
8. Let *prototype* be *OrdinaryObjectCreate*(%*AsyncGeneratorFunction.prototype.prototype*%).
9. Perform ! *DefinePropertyOrThrow*(*closure*, "prototype", *PropertyDescriptor* { *[[Value]]*: *prototype*, *[[Writable]]*: true, *[[Enumerable]]*: false, *[[Configurable]]*: false }).
10. Return *DefineMethodProperty*(*object*, *propKey*, *closure*, *enumerable*).

*AsyncMethod* : **async** *ClassElementName* ( *UniqueFormalParameters* ) { *AsyncFunctionBody* }

1. Let *propKey* be ? *Evaluation* of *ClassElementName*.
2. Let *env* be the *LexicalEnvironment* of the *running execution context*.
3. Let *privateEnv* be the *running execution context*'s *PrivateEnvironment*.
4. Let *sourceText* be the *source text* matched by *AsyncMethod*.
5. Let *closure* be *OrdinaryFunctionCreate*(%*AsyncFunction.prototype*%, *sourceText*, *UniqueFormalParameters*, *AsyncFunctionBody*, non-lexical-this, *env*, *privateEnv*).
6. Perform *MakeMethod*(*closure*, *object*).
7. Perform *SetFunctionName*(*closure*, *propKey*).
8. Return *DefineMethodProperty*(*object*, *propKey*, *closure*, *enumerable*).

## 15.5 Generator Function Definitions

### Syntax

```

GeneratorDeclaration[Yield, Await, Default] :
    function * BindingIdentifier[?Yield, ?Await] ( FormalParameters[+Yield, ~Await]
        ) { GeneratorBody }
    [+Default] function * ( FormalParameters[+Yield, ~Await] ) { GeneratorBody }

```

*GeneratorExpression* :

```
function * BindingIdentifier[+Yield, ~Await] opt (
  FormalParameters[+Yield, ~Await] ) { GeneratorBody }
```

*GeneratorMethod*<sub>[Yield, Await]</sub> :

```
* ClassElementName[?Yield, ?Await] ( UniqueFormalParameters[+Yield, ~Await] )
  { GeneratorBody }
```

*GeneratorBody* :

```
FunctionBody[+Yield, ~Await]
```

*YieldExpression*<sub>[In, Await]</sub> :

```
yield
yield [no LineTerminator here] AssignmentExpression[?In, +Yield, ?Await]
yield [no LineTerminator here] * AssignmentExpression[?In, +Yield, ?Await]
```

NOTE 1 The syntactic context immediately following **yield** requires use of the *InputElementRegExpOrTemplateTail* lexical goal.

NOTE 2 *YieldExpression* cannot be used within the *FormalParameters* of a generator function because any expressions that are part of *FormalParameters* are evaluated before the resulting Generator is in a resumable state.

NOTE 3 [Abstract operations](#) relating to Generators are defined in [27.5.3](#).

### 15.5.1 Static Semantics: Early Errors

*GeneratorMethod* : \* *ClassElementName* ( *UniqueFormalParameters* ) { *GeneratorBody* }

- It is a Syntax Error if [HasDirectSuper](#) of *GeneratorMethod* is **true**.
- It is a Syntax Error if *UniqueFormalParameters* [Contains](#) *YieldExpression* is **true**.
- It is a Syntax Error if [FunctionBodyContainsUseStrict](#) of *GeneratorBody* is **true** and [IsSimpleParameterList](#) of *UniqueFormalParameters* is **false**.
- It is a Syntax Error if any element of the [BoundNames](#) of *UniqueFormalParameters* also occurs in the [LexicallyDeclaredNames](#) of *GeneratorBody*.

*GeneratorDeclaration* :

```
function * BindingIdentifier ( FormalParameters ) { GeneratorBody }
function * ( FormalParameters ) { GeneratorBody }
```

*GeneratorExpression* :

```
function * BindingIdentifieropt ( FormalParameters ) { GeneratorBody }
```

- If the [source text matched by](#) *FormalParameters* is [strict mode code](#), the Early Error rules for *UniqueFormalParameters* : *FormalParameters* are applied.
- If *BindingIdentifier* is present and the [source text matched by](#) *BindingIdentifier* is [strict mode code](#), it is a Syntax Error if the [StringValue](#) of *BindingIdentifier* is either **"eval"** or **"arguments"**.
- It is a Syntax Error if [FunctionBodyContainsUseStrict](#) of *GeneratorBody* is **true** and [IsSimpleParameterList](#) of *FormalParameters* is **false**.
- It is a Syntax Error if any element of the [BoundNames](#) of *FormalParameters* also occurs in the [LexicallyDeclaredNames](#) of *GeneratorBody*.
- It is a Syntax Error if *FormalParameters* [Contains](#) *YieldExpression* is **true**.
- It is a Syntax Error if *FormalParameters* [Contains](#) *SuperProperty* is **true**.
- It is a Syntax Error if *GeneratorBody* [Contains](#) *SuperProperty* is **true**.
- It is a Syntax Error if *FormalParameters* [Contains](#) *SuperCall* is **true**.

- It is a Syntax Error if *GeneratorBody* **Contains SuperCall** is **true**.

### 15.5.2 Runtime Semantics: EvaluateGeneratorBody

The *syntax-directed operation* EvaluateGeneratorBody takes arguments *functionObject* (a function object) and *argumentsList* (a List of ECMAScript language values) and returns a *throw completion* or a *return completion*. It is defined piecewise over the following productions:

*GeneratorBody* : *FunctionBody*

1. Perform ? *FunctionDeclarationInstantiation*(*functionObject*, *argumentsList*).
2. Let *G* be ? *OrdinaryCreateFromConstructor*(*functionObject*, "%GeneratorFunction.prototype.prototype%", « [[GeneratorState]], [[GeneratorContext]], [[GeneratorBrand]] »).
3. Set *G*.[[GeneratorBrand]] to empty.
4. Perform *GeneratorStart*(*G*, *FunctionBody*).
5. Return *Completion Record* { [[Type]]: return, [[Value]]: *G*, [[Target]]: empty }.

### 15.5.3 Runtime Semantics: InstantiateGeneratorFunctionObject

The *syntax-directed operation* InstantiateGeneratorFunctionObject takes arguments *env* (an *Environment Record*) and *privateEnv* (a *PrivateEnvironment Record* or **null**) and returns a *function object*. It is defined piecewise over the following productions:

*GeneratorDeclaration* : **function** \* *BindingIdentifier* ( *FormalParameters* ) { *GeneratorBody* }

1. Let *name* be *StringValue* of *BindingIdentifier*.
2. Let *sourceText* be the *source text matched by GeneratorDeclaration*.
3. Let *F* be *OrdinaryFunctionCreate*(%GeneratorFunction.prototype%, *sourceText*, *FormalParameters*, *GeneratorBody*, non-lexical-this, *env*, *privateEnv*).
4. Perform *SetFunctionName*(*F*, *name*).
5. Let *prototype* be *OrdinaryObjectCreate*(%GeneratorFunction.prototype.prototype%).
6. Perform ! *DefinePropertyOrThrow*(*F*, "prototype", PropertyDescriptor { [[Value]]: *prototype*, [[Writable]]: **true**, [[Enumerable]]: **false**, [[Configurable]]: **false** }).
7. Return *F*.

*GeneratorDeclaration* : **function** \* ( *FormalParameters* ) { *GeneratorBody* }

1. Let *sourceText* be the *source text matched by GeneratorDeclaration*.
2. Let *F* be *OrdinaryFunctionCreate*(%GeneratorFunction.prototype%, *sourceText*, *FormalParameters*, *GeneratorBody*, non-lexical-this, *env*, *privateEnv*).
3. Perform *SetFunctionName*(*F*, "default").
4. Let *prototype* be *OrdinaryObjectCreate*(%GeneratorFunction.prototype.prototype%).
5. Perform ! *DefinePropertyOrThrow*(*F*, "prototype", PropertyDescriptor { [[Value]]: *prototype*, [[Writable]]: **true**, [[Enumerable]]: **false**, [[Configurable]]: **false** }).
6. Return *F*.

**NOTE** An anonymous *GeneratorDeclaration* can only occur as part of an **export default** declaration, and its function code is therefore always *strict mode code*.

## 15.5.4 Runtime Semantics: InstantiateGeneratorFunctionExpression

The [syntax-directed operation](#) `InstantiateGeneratorFunctionExpression` takes optional argument *name* (a [property key](#) or a [Private Name](#)) and returns a [function object](#). It is defined piecewise over the following productions:

*GeneratorExpression* : **function** \* ( *FormalParameters* ) { *GeneratorBody* }

1. If *name* is not present, set *name* to "".
2. Let *env* be the [LexicalEnvironment](#) of the [running execution context](#).
3. Let *privateEnv* be the [running execution context](#)'s [PrivateEnvironment](#).
4. Let *sourceText* be the [source text](#) matched by *GeneratorExpression*.
5. Let *closure* be [OrdinaryFunctionCreate](#)(%[GeneratorFunction.prototype](#)%, *sourceText*, *FormalParameters*, *GeneratorBody*, non-lexical-this, *env*, *privateEnv*).
6. Perform [SetFunctionName](#)(*closure*, *name*).
7. Let *prototype* be [OrdinaryObjectCreate](#)(%[GeneratorFunction.prototype.prototype](#)%).
8. Perform ! [DefinePropertyOrThrow](#)(*closure*, "prototype", [PropertyDescriptor](#) { [\[\[Value\]\]](#): *prototype*, [\[\[Writable\]\]](#): **true**, [\[\[Enumerable\]\]](#): **false**, [\[\[Configurable\]\]](#): **false** }).
9. Return *closure*.

*GeneratorExpression* : **function** \* *BindingIdentifier* ( *FormalParameters* ) { *GeneratorBody* }

1. [Assert](#): *name* is not present.
2. Set *name* to [StringValue](#) of *BindingIdentifier*.
3. Let *outerEnv* be the [running execution context](#)'s [LexicalEnvironment](#).
4. Let *funcEnv* be [NewDeclarativeEnvironment](#)(*outerEnv*).
5. Perform ! *funcEnv*.[CreateImmutableBinding](#)(*name*, **false**).
6. Let *privateEnv* be the [running execution context](#)'s [PrivateEnvironment](#).
7. Let *sourceText* be the [source text](#) matched by *GeneratorExpression*.
8. Let *closure* be [OrdinaryFunctionCreate](#)(%[GeneratorFunction.prototype](#)%, *sourceText*, *FormalParameters*, *GeneratorBody*, non-lexical-this, *funcEnv*, *privateEnv*).
9. Perform [SetFunctionName](#)(*closure*, *name*).
10. Let *prototype* be [OrdinaryObjectCreate](#)(%[GeneratorFunction.prototype.prototype](#)%).
11. Perform ! [DefinePropertyOrThrow](#)(*closure*, "prototype", [PropertyDescriptor](#) { [\[\[Value\]\]](#): *prototype*, [\[\[Writable\]\]](#): **true**, [\[\[Enumerable\]\]](#): **false**, [\[\[Configurable\]\]](#): **false** }).
12. Perform ! *funcEnv*.[InitializeBinding](#)(*name*, *closure*).
13. Return *closure*.

**NOTE** The *BindingIdentifier* in a *GeneratorExpression* can be referenced from inside the *GeneratorExpression*'s *FunctionBody* to allow the generator code to call itself recursively. However, unlike in a *GeneratorDeclaration*, the *BindingIdentifier* in a *GeneratorExpression* cannot be referenced from and does not affect the scope enclosing the *GeneratorExpression*.

## 15.5.5 Runtime Semantics: Evaluation

*GeneratorExpression* : **function** \* *BindingIdentifier*<sub>opt</sub> ( *FormalParameters* ) { *GeneratorBody* }

1. Return [InstantiateGeneratorFunctionExpression](#) of *GeneratorExpression*.

*YieldExpression* : **yield**

1. Return ? [Yield](#)(**undefined**).

*YieldExpression* : **yield** *AssignmentExpression*



1. Let *exprRef* be ? [Evaluation](#) of *AssignmentExpression*.
2. Let *value* be ? [GetValue](#)(*exprRef*).
3. Return ? [Yield](#)(*value*).

*YieldExpression* : **yield** \* *AssignmentExpression*

1. Let *generatorKind* be [GetGeneratorKind](#)().
2. Let *exprRef* be ? [Evaluation](#) of *AssignmentExpression*.
3. Let *value* be ? [GetValue](#)(*exprRef*).
4. Let *iteratorRecord* be ? [GetIterator](#)(*value*, *generatorKind*).
5. Let *iterator* be *iteratorRecord*.[[Iterator]].
6. Let *received* be [NormalCompletion](#)(**undefined**).
7. Repeat,
  - a. If *received*.[[Type]] is normal, then
    - i. Let *innerResult* be ? [Call](#)(*iteratorRecord*.[[NextMethod]], *iteratorRecord*.[[Iterator]], « *received*.[[Value]] »).
    - ii. If *generatorKind* is async, set *innerResult* to ? [Await](#)(*innerResult*).
    - iii. If *innerResult* is not an Object, throw a **TypeError** exception.
    - iv. Let *done* be ? [IteratorComplete](#)(*innerResult*).
    - v. If *done* is **true**, then
      1. Return ? [IteratorValue](#)(*innerResult*).
    - vi. If *generatorKind* is async, set *received* to [Completion](#)([AsyncGeneratorYield](#)(? [IteratorValue](#)(*innerResult*))).
    - vii. Else, set *received* to [Completion](#)([GeneratorYield](#)(*innerResult*)).
  - b. Else if *received*.[[Type]] is throw, then
    - i. Let *throw* be ? [GetMethod](#)(*iterator*, "throw").
    - ii. If *throw* is not **undefined**, then
      1. Let *innerResult* be ? [Call](#)(*throw*, *iterator*, « *received*.[[Value]] »).
      2. If *generatorKind* is async, set *innerResult* to ? [Await](#)(*innerResult*).
      3. NOTE: Exceptions from the inner iterator **throw** method are propagated. [Normal completions](#) from an inner **throw** method are processed similarly to an inner **next**.
      4. If *innerResult* is not an Object, throw a **TypeError** exception.
      5. Let *done* be ? [IteratorComplete](#)(*innerResult*).
      6. If *done* is **true**, then
        - a. Return ? [IteratorValue](#)(*innerResult*).
      7. If *generatorKind* is async, set *received* to [Completion](#)([AsyncGeneratorYield](#)(? [IteratorValue](#)(*innerResult*))).
      8. Else, set *received* to [Completion](#)([GeneratorYield](#)(*innerResult*)).
    - iii. Else,
      1. NOTE: If *iterator* does not have a **throw** method, this throw is going to terminate the **yield**\* loop. But first we need to give *iterator* a chance to clean up.
      2. Let *closeCompletion* be [Completion Record](#) { [[Type]]: normal, [[Value]]: empty, [[Target]]: empty }.
      3. If *generatorKind* is async, perform ? [AsyncIteratorClose](#)(*iteratorRecord*, *closeCompletion*).
      4. Else, perform ? [IteratorClose](#)(*iteratorRecord*, *closeCompletion*).
      5. NOTE: The next step throws a **TypeError** to indicate that there was a **yield**\* protocol violation: *iterator* does not have a **throw** method.
      6. Throw a **TypeError** exception.
  - c. Else,

- i. **Assert**: *received*.[[Type]] is return.
- ii. Let *return* be ? *GetMethod*(*iterator*, "return").
- iii. If *return* is **undefined**, then
  1. Let *value* be *received*.[[Value]].
  2. If *generatorKind* is **async**, then
    - a. Set *value* to ? *Await*(*value*).
  3. Return **Completion Record** { [[Type]]: return, [[Value]]: *value*, [[Target]]: empty }.
- iv. Let *innerReturnResult* be ? *Call*(*return*, *iterator*, « *received*.[[Value]] »).
- v. If *generatorKind* is **async**, set *innerReturnResult* to ? *Await*(*innerReturnResult*).
- vi. If *innerReturnResult* is not an **Object**, throw a **TypeError** exception.
- vii. Let *done* be ? *IteratorComplete*(*innerReturnResult*).
- viii. If *done* is **true**, then
  1. Let *value* be ? *IteratorValue*(*innerReturnResult*).
  2. Return **Completion Record** { [[Type]]: return, [[Value]]: *value*, [[Target]]: empty }.
- ix. If *generatorKind* is **async**, set *received* to *Completion*(*AsyncGeneratorYield*(? *IteratorValue*(*innerReturnResult*))).
- x. Else, set *received* to *Completion*(*GeneratorYield*(*innerReturnResult*)).

## 15.6 Async Generator Function Definitions

### Syntax

```

AsyncGeneratorDeclaration[Yield, Await, Default] :
  async [no LineTerminator here] function * BindingIdentifier[?Yield, ?Await] (
    FormalParameters[+Yield, +Await] ) { AsyncGeneratorBody }
  [+Default] async [no LineTerminator here] function * (
    FormalParameters[+Yield, +Await] ) { AsyncGeneratorBody }
  
```

```

AsyncGeneratorExpression :
  async [no LineTerminator here] function * BindingIdentifier[+Yield, +Await] opt (
    FormalParameters[+Yield, +Await] ) { AsyncGeneratorBody }
  
```

```

AsyncGeneratorMethod[Yield, Await] :
  async [no LineTerminator here] * ClassElementName[?Yield, ?Await] (
    UniqueFormalParameters[+Yield, +Await] ) { AsyncGeneratorBody }
  
```

```

AsyncGeneratorBody :
  FunctionBody[+Yield, +Await]
  
```

NOTE 1 *YieldExpression* and *AwaitExpression* cannot be used within the *FormalParameters* of an **async** generator function because any expressions that are part of *FormalParameters* are evaluated before the resulting **AsyncGenerator** is in a resumable state.

NOTE 2 [Abstract operations](#) relating to **AsyncGenerators** are defined in [27.6.3](#).

### 15.6.1 Static Semantics: Early Errors

```

AsyncGeneratorMethod : async * ClassElementName ( UniqueFormalParameters ) {
  AsyncGeneratorBody }
  
```

- It is a Syntax Error if *HasDirectSuper* of *AsyncGeneratorMethod* is **true**.
- It is a Syntax Error if *UniqueFormalParameters* *Contains* *YieldExpression* is **true**.

- It is a Syntax Error if *UniqueFormalParameters* **Contains** *AwaitExpression* is **true**.
- It is a Syntax Error if **FunctionBodyContainsUseStrict** of *AsyncGeneratorBody* is **true** and **IsSimpleParameterList** of *UniqueFormalParameters* is **false**.
- It is a Syntax Error if any element of the **BoundNames** of *UniqueFormalParameters* also occurs in the **LexicallyDeclaredNames** of *AsyncGeneratorBody*.

*AsyncGeneratorDeclaration* :

```
async function * BindingIdentifier ( FormalParameters ) { AsyncGeneratorBody }
async function * ( FormalParameters ) { AsyncGeneratorBody }
```

*AsyncGeneratorExpression* :

```
async function * BindingIdentifieropt ( FormalParameters ) { AsyncGeneratorBody }
```

- If the **source text matched by** *FormalParameters* is **strict mode code**, the Early Error rules for *UniqueFormalParameters* : *FormalParameters* are applied.
- If *BindingIdentifier* is present and the **source text matched by** *BindingIdentifier* is **strict mode code**, it is a Syntax Error if the **StringValue** of *BindingIdentifier* is either **"eval"** or **"arguments"**.
- It is a Syntax Error if **FunctionBodyContainsUseStrict** of *AsyncGeneratorBody* is **true** and **IsSimpleParameterList** of *FormalParameters* is **false**.
- It is a Syntax Error if any element of the **BoundNames** of *FormalParameters* also occurs in the **LexicallyDeclaredNames** of *AsyncGeneratorBody*.
- It is a Syntax Error if *FormalParameters* **Contains** *YieldExpression* is **true**.
- It is a Syntax Error if *FormalParameters* **Contains** *AwaitExpression* is **true**.
- It is a Syntax Error if *FormalParameters* **Contains** *SuperProperty* is **true**.
- It is a Syntax Error if *AsyncGeneratorBody* **Contains** *SuperProperty* is **true**.
- It is a Syntax Error if *FormalParameters* **Contains** *SuperCall* is **true**.
- It is a Syntax Error if *AsyncGeneratorBody* **Contains** *SuperCall* is **true**.

### 15.6.2 Runtime Semantics: EvaluateAsyncGeneratorBody

The **syntax-directed operation** *EvaluateAsyncGeneratorBody* takes arguments *functionObject* (a **function object**) and *argumentsList* (a **List of ECMAScript language values**) and returns a **throw completion** or a **return completion**. It is defined piecewise over the following productions:

*AsyncGeneratorBody* : *FunctionBody*

1. Perform ? **FunctionDeclarationInstantiation**(*functionObject*, *argumentsList*).
2. Let *generator* be ? **OrdinaryCreateFromConstructor**(*functionObject*, **"%AsyncGeneratorFunction.prototype.prototype%"**, « [[*AsyncGeneratorState*]], [[*AsyncGeneratorContext*]], [[*AsyncGeneratorQueue*]], [[*GeneratorBrand*]] »).
3. Set *generator*.[[*GeneratorBrand*]] to empty.
4. Perform **AsyncGeneratorStart**(*generator*, *FunctionBody*).
5. Return **Completion Record** { [[*Type*]]: **return**, [[*Value*]]: *generator*, [[*Target*]]: empty }.

### 15.6.3 Runtime Semantics: InstantiateAsyncGeneratorFunctionObject

The **syntax-directed operation** *InstantiateAsyncGeneratorFunctionObject* takes arguments *env* (an **Environment Record**) and *privateEnv* (a **PrivateEnvironment Record** or **null**) and returns a **function object**. It is defined piecewise over the following productions:

*AsyncGeneratorDeclaration* : **async function** \* *BindingIdentifier* ( *FormalParameters* ) { *AsyncGeneratorBody* }

1. Let *name* be *StringValue* of *BindingIdentifier*.
2. Let *sourceText* be the *source text* matched by *AsyncGeneratorDeclaration*.
3. Let *F* be *OrdinaryFunctionCreate*(%*AsyncGeneratorFunction.prototype*%, *sourceText*, *FormalParameters*, *AsyncGeneratorBody*, non-lexical-this, *env*, *privateEnv*).
4. Perform *SetFunctionName*(*F*, *name*).
5. Let *prototype* be *OrdinaryObjectCreate*(%*AsyncGeneratorFunction.prototype.prototype*%).
6. Perform ! *DefinePropertyOrThrow*(*F*, "prototype", PropertyDescriptor { [[Value]]: *prototype*, [[Writable]]: true, [[Enumerable]]: false, [[Configurable]]: false }).
7. Return *F*.

*AsyncGeneratorDeclaration* : **async function** \* ( *FormalParameters* ) { *AsyncGeneratorBody* }

1. Let *sourceText* be the *source text* matched by *AsyncGeneratorDeclaration*.
2. Let *F* be *OrdinaryFunctionCreate*(%*AsyncGeneratorFunction.prototype*%, *sourceText*, *FormalParameters*, *AsyncGeneratorBody*, non-lexical-this, *env*, *privateEnv*).
3. Perform *SetFunctionName*(*F*, "default").
4. Let *prototype* be *OrdinaryObjectCreate*(%*AsyncGeneratorFunction.prototype.prototype*%).
5. Perform ! *DefinePropertyOrThrow*(*F*, "prototype", PropertyDescriptor { [[Value]]: *prototype*, [[Writable]]: true, [[Enumerable]]: false, [[Configurable]]: false }).
6. Return *F*.

**NOTE** An anonymous *AsyncGeneratorDeclaration* can only occur as part of an **export default** declaration.

### 15.6.4 Runtime Semantics: InstantiateAsyncGeneratorFunctionExpression

The *syntax-directed operation* *InstantiateAsyncGeneratorFunctionExpression* takes optional argument *name* (a *property key* or a *Private Name*) and returns a *function object*. It is defined piecewise over the following productions:

*AsyncGeneratorExpression* : **async function** \* ( *FormalParameters* ) { *AsyncGeneratorBody* }

1. If *name* is not present, set *name* to "".
2. Let *env* be the *LexicalEnvironment* of the *running execution context*.
3. Let *privateEnv* be the *running execution context*'s *PrivateEnvironment*.
4. Let *sourceText* be the *source text* matched by *AsyncGeneratorExpression*.
5. Let *closure* be *OrdinaryFunctionCreate*(%*AsyncGeneratorFunction.prototype*%, *sourceText*, *FormalParameters*, *AsyncGeneratorBody*, non-lexical-this, *env*, *privateEnv*).
6. Perform *SetFunctionName*(*closure*, *name*).
7. Let *prototype* be *OrdinaryObjectCreate*(%*AsyncGeneratorFunction.prototype.prototype*%).
8. Perform ! *DefinePropertyOrThrow*(*closure*, "prototype", PropertyDescriptor { [[Value]]: *prototype*, [[Writable]]: true, [[Enumerable]]: false, [[Configurable]]: false }).
9. Return *closure*.

*AsyncGeneratorExpression* : **async function** \* *BindingIdentifier* ( *FormalParameters* ) { *AsyncGeneratorBody* }

1. **Assert**: *name* is not present.
2. Set *name* to *StringValue* of *BindingIdentifier*.
3. Let *outerEnv* be the *running execution context*'s *LexicalEnvironment*.
4. Let *funcEnv* be *NewDeclarativeEnvironment*(*outerEnv*).
5. Perform ! *funcEnv*.*CreateImmutableBinding*(*name*, **false**).

6. Let *privateEnv* be the running execution context's PrivateEnvironment.
7. Let *sourceText* be the source text matched by *AsyncGeneratorExpression*.
8. Let *closure* be `OrdinaryFunctionCreate(%AsyncGeneratorFunction.prototype%, sourceText, FormalParameters, AsyncGeneratorBody, non-lexical-this, funcEnv, privateEnv)`.
9. Perform `SetFunctionName(closure, name)`.
10. Let *prototype* be `OrdinaryObjectCreate(%AsyncGeneratorFunction.prototype.prototype%)`.
11. Perform ! `DefinePropertyOrThrow(closure, "prototype", PropertyDescriptor { [[Value]]: prototype, [[Writable]]: true, [[Enumerable]]: false, [[Configurable]]: false })`.
12. Perform ! `funcEnv.InitializeBinding(name, closure)`.
13. Return *closure*.

**NOTE** The *BindingIdentifier* in an *AsyncGeneratorExpression* can be referenced from inside the *AsyncGeneratorExpression*'s *AsyncGeneratorBody* to allow the generator code to call itself recursively. However, unlike in an *AsyncGeneratorDeclaration*, the *BindingIdentifier* in an *AsyncGeneratorExpression* cannot be referenced from and does not affect the scope enclosing the *AsyncGeneratorExpression*.

### 15.6.5 Runtime Semantics: Evaluation

*AsyncGeneratorExpression* : **async function** \* *BindingIdentifier*<sub>opt</sub> ( *FormalParameters* ) { *AsyncGeneratorBody* }

1. Return `InstantiateAsyncGeneratorFunctionExpression` of *AsyncGeneratorExpression*.

## 15.7 Class Definitions

### Syntax

```

ClassDeclaration[Yield, Await, Default] :
    class BindingIdentifier[?Yield, ?Await] ClassTail[?Yield, ?Await]
    [+Default] class ClassTail[?Yield, ?Await]

ClassExpression[Yield, Await] :
    class BindingIdentifier[?Yield, ?Await]opt ClassTail[?Yield, ?Await]

ClassTail[Yield, Await] :
    ClassHeritage[?Yield, ?Await]opt { ClassBody[?Yield, ?Await]opt }

ClassHeritage[Yield, Await] :
    extends LeftHandSideExpression[?Yield, ?Await]

ClassBody[Yield, Await] :
    ClassElementList[?Yield, ?Await]

ClassElementList[Yield, Await] :
    ClassElement[?Yield, ?Await]
    ClassElementList[?Yield, ?Await] ClassElement[?Yield, ?Await]

ClassElement[Yield, Await] :
    MethodDefinition[?Yield, ?Await]

```

```

static MethodDefinition[?Yield, ?Await]
FieldDefinition[?Yield, ?Await] ;
static FieldDefinition[?Yield, ?Await] ;
ClassStaticBlock
;

FieldDefinition[Yield, Await] :
  ClassElementName[?Yield, ?Await] Initializer[+In, ?Yield, ?Await] opt

ClassElementName[Yield, Await] :
 PropertyName[?Yield, ?Await]
  PrivateIdentifier

ClassStaticBlock :
  static { ClassStaticBlockBody }

ClassStaticBlockBody :
  ClassStaticBlockStatementList

ClassStaticBlockStatementList :
  StatementList[~Yield, +Await, ~Return] opt

```

**NOTE** A class definition is always [strict mode code](#).

### 15.7.1 Static Semantics: Early Errors

*ClassTail* : *ClassHeritage*<sub>opt</sub> { *ClassBody* }

- It is a Syntax Error if *ClassHeritage* is not present and the following algorithm returns **true**:
  - Let *constructor* be [ConstructorMethod](#) of *ClassBody*.
  - If *constructor* is empty, return **false**.
  - Return [HasDirectSuper](#) of *constructor*.

*ClassBody* : *ClassElementList*

- It is a Syntax Error if [PrototypePropertyNameList](#) of *ClassElementList* contains more than one occurrence of "**constructor**".
- It is a Syntax Error if [PrivateBoundIdentifiers](#) of *ClassElementList* contains any duplicate entries, unless the name is used once for a getter and once for a setter and in no other entries, and the getter and setter are either both static or both non-static.

*ClassElement* : *MethodDefinition*

- It is a Syntax Error if [PropName](#) of *MethodDefinition* is not "**constructor**" and [HasDirectSuper](#) of *MethodDefinition* is **true**.
- It is a Syntax Error if [PropName](#) of *MethodDefinition* is "**constructor**" and [SpecialMethod](#) of *MethodDefinition* is **true**.

*ClassElement* : **static** *MethodDefinition*

- It is a Syntax Error if [HasDirectSuper](#) of *MethodDefinition* is **true**.
- It is a Syntax Error if [PropName](#) of *MethodDefinition* is "**prototype**".

*ClassElement* : *FieldDefinition* ;

- It is a Syntax Error if [PropName](#) of *FieldDefinition* is "**constructor**".

*ClassElement* : **static** *FieldDefinition* ;

- It is a Syntax Error if *PropName* of *FieldDefinition* is either "**prototype**" or "**constructor**".

*FieldDefinition* :

*ClassElementName* *Initializer*<sub>opt</sub>

- It is a Syntax Error if *Initializer* is present and *ContainsArguments* of *Initializer* is **true**.
- It is a Syntax Error if *Initializer* is present and *Initializer Contains SuperCall* is **true**.

*ClassElementName* : *PrivateIdentifier*

- It is a Syntax Error if *StringValue* of *PrivateIdentifier* is "**#constructor**".

*ClassStaticBlockBody* : *ClassStaticBlockStatementList*

- It is a Syntax Error if the *LexicallyDeclaredNames* of *ClassStaticBlockStatementList* contains any duplicate entries.
- It is a Syntax Error if any element of the *LexicallyDeclaredNames* of *ClassStaticBlockStatementList* also occurs in the *VarDeclaredNames* of *ClassStaticBlockStatementList*.
- It is a Syntax Error if *ContainsDuplicateLabels* of *ClassStaticBlockStatementList* with argument « » is **true**.
- It is a Syntax Error if *ContainsUndefinedBreakTarget* of *ClassStaticBlockStatementList* with argument « » is **true**.
- It is a Syntax Error if *ContainsUndefinedContinueTarget* of *ClassStaticBlockStatementList* with arguments « » and « » is **true**.
- It is a Syntax Error if *ContainsArguments* of *ClassStaticBlockStatementList* is **true**.
- It is a Syntax Error if *ClassStaticBlockStatementList Contains SuperCall* is **true**.
- It is a Syntax Error if *ClassStaticBlockStatementList Contains await* is **true**.

### 15.7.2 Static Semantics: *ClassElementKind*

The *syntax-directed operation* *ClassElementKind* takes no arguments and returns *ConstructorMethod*, *NonConstructorMethod*, or empty. It is defined piecewise over the following productions:

*ClassElement* : *MethodDefinition*

1. If *PropName* of *MethodDefinition* is "**constructor**", return *ConstructorMethod*.
2. Return *NonConstructorMethod*.

*ClassElement* :

**static** *MethodDefinition*  
*FieldDefinition* ;  
**static** *FieldDefinition* ;

1. Return *NonConstructorMethod*.

*ClassElement* : *ClassStaticBlock*

1. Return *NonConstructorMethod*.

*ClassElement* : ;

1. Return empty.

### 15.7.3 Static Semantics: *ConstructorMethod*

The *syntax-directed operation* *ConstructorMethod* takes no arguments and returns a *ClassElement Parse Node* or empty. It is defined piecewise over the following productions:

*ClassElementList* : *ClassElement*

1. If `ClassElementKind` of `ClassElement` is `ConstructorMethod`, return `ClassElement`.
2. Return empty.

*ClassElementList* : *ClassElementList* *ClassElement*

1. Let *head* be `ConstructorMethod` of *ClassElementList*.
2. If *head* is not empty, return *head*.
3. If `ClassElementKind` of `ClassElement` is `ConstructorMethod`, return `ClassElement`.
4. Return empty.

**NOTE** Early Error rules ensure that there is only one method definition named "**constructor**" and that it is not an `accessor property` or generator definition.

#### 15.7.4 Static Semantics: `IsStatic`

The `syntax-directed operation` `IsStatic` takes no arguments and returns a Boolean. It is defined piecewise over the following productions:

*ClassElement* : *MethodDefinition*

1. Return **false**.

*ClassElement* : **static** *MethodDefinition*

1. Return **true**.

*ClassElement* : *FieldDefinition* ;

1. Return **false**.

*ClassElement* : **static** *FieldDefinition* ;

1. Return **true**.

*ClassElement* : *ClassStaticBlock*

1. Return **true**.

*ClassElement* : ;

1. Return **false**.

#### 15.7.5 Static Semantics: `NonConstructorElements`

The `syntax-directed operation` `NonConstructorElements` takes no arguments and returns a `List` of `ClassElement` `Parse Nodes`. It is defined piecewise over the following productions:

*ClassElementList* : *ClassElement*

1. If `ClassElementKind` of `ClassElement` is `NonConstructorMethod`, then
  - a. Return « `ClassElement` ».
2. Return a new empty `List`.

*ClassElementList* : *ClassElementList* *ClassElement*

1. Let *list* be `NonConstructorElements` of *ClassElementList*.



2. If `ClassElementKind` of `ClassElement` is `NonConstructorMethod`, then
  - a. Append `ClassElement` to the end of `list`.
3. Return `list`.

### 15.7.6 Static Semantics: PrototypePropertyNameList

The [syntax-directed operation](#) `PrototypePropertyNameList` takes no arguments and returns a [List](#) of [property keys](#). It is defined piecewise over the following productions:

*ClassElementList* : *ClassElement*

1. Let `propName` be `PropName` of `ClassElement`.
2. If `propName` is empty, return a new empty [List](#).
3. If `IsStatic` of `ClassElement` is **true**, return a new empty [List](#).
4. Return « `propName` ».

*ClassElementList* : *ClassElementList* *ClassElement*

1. Let `list` be `PrototypePropertyNameList` of `ClassElementList`.
2. Let `propName` be `PropName` of `ClassElement`.
3. If `propName` is empty, return `list`.
4. If `IsStatic` of `ClassElement` is **true**, return `list`.
5. Return the [list-concatenation](#) of `list` and « `propName` ».

### 15.7.7 Static Semantics: AllPrivateIdentifiersValid

The [syntax-directed operation](#) `AllPrivateIdentifiersValid` takes argument `names` (a [List](#) of [Strings](#)) and returns a [Boolean](#).

Every grammar production alternative in this specification which is not listed below implicitly has the following default definition of `AllPrivateIdentifiersValid`:

1. For each child node `child` of this [Parse Node](#), do
  - a. If `child` is an instance of a nonterminal, then
    - i. If `AllPrivateIdentifiersValid` of `child` with argument `names` is **false**, return **false**.
2. Return **true**.

*MemberExpression* : *MemberExpression* . *PrivateIdentifier*

1. If `names` contains the [StringValue](#) of `PrivateIdentifier`, then
  - a. Return `AllPrivateIdentifiersValid` of `MemberExpression` with argument `names`.
2. Return **false**.

*CallExpression* : *CallExpression* . *PrivateIdentifier*

1. If `names` contains the [StringValue](#) of `PrivateIdentifier`, then
  - a. Return `AllPrivateIdentifiersValid` of `CallExpression` with argument `names`.
2. Return **false**.

*OptionalChain* : *?* . *PrivateIdentifier*

1. If `names` contains the [StringValue](#) of `PrivateIdentifier`, return **true**.
2. Return **false**.

*OptionalChain* : *OptionalChain* . *PrivateIdentifier*

1. If *names* contains the *StringValue* of *PrivateIdentifier*, then
  - a. Return *AllPrivateIdentifiersValid* of *OptionalChain* with argument *names*.
2. Return **false**.

*ClassBody* : *ClassElementList*

1. Let *newNames* be the list-concatenation of *names* and *PrivateBoundIdentifiers* of *ClassBody*.
2. Return *AllPrivateIdentifiersValid* of *ClassElementList* with argument *newNames*.

*RelationalExpression* : *PrivateIdentifier* **in** *ShiftExpression*

1. If *names* contains the *StringValue* of *PrivateIdentifier*, then
  - a. Return *AllPrivateIdentifiersValid* of *ShiftExpression* with argument *names*.
2. Return **false**.

### 15.7.8 Static Semantics: PrivateBoundIdentifiers

The *syntax-directed operation* *PrivateBoundIdentifiers* takes no arguments and returns a *List* of Strings. It is defined piecewise over the following productions:

*FieldDefinition* : *ClassElementName* *Initializer*<sub>opt</sub>

1. Return *PrivateBoundIdentifiers* of *ClassElementName*.

*ClassElementName* : *PrivateIdentifier*

1. Return a *List* whose sole element is the *StringValue* of *PrivateIdentifier*.

*ClassElementName* :  
*PropertyName*

*ClassElement* :  
*ClassStaticBlock*  
;

1. Return a new empty *List*.

*ClassElementList* : *ClassElementList* *ClassElement*

1. Let *names1* be *PrivateBoundIdentifiers* of *ClassElementList*.
2. Let *names2* be *PrivateBoundIdentifiers* of *ClassElement*.
3. Return the list-concatenation of *names1* and *names2*.

*MethodDefinition* :

```
ClassElementName ( UniqueFormalParameters ) { FunctionBody }
get ClassElementName ( ) { FunctionBody }
set ClassElementName ( PropertySetParameterList ) { FunctionBody }
```

*GeneratorMethod* :

```
* ClassElementName ( UniqueFormalParameters ) { GeneratorBody }
```

*AsyncMethod* :

```
async ClassElementName ( UniqueFormalParameters ) { AsyncFunctionBody }
```

*AsyncGeneratorMethod* :

```
async * ClassElementName ( UniqueFormalParameters ) { AsyncGeneratorBody }
```

1. Return *PrivateBoundIdentifiers* of *ClassElementName*.

## 15.7.9 Static Semantics: ContainsArguments

The [syntax-directed operation](#) ContainsArguments takes no arguments and returns a Boolean.

Every grammar production alternative in this specification which is not listed below implicitly has the following default definition of ContainsArguments:

1. For each child node *child* of this [Parse Node](#), do
  - a. If *child* is an instance of a nonterminal, then
    - i. If [ContainsArguments](#) of *child* is **true**, return **true**.
2. Return **false**.

*IdentifierReference* : *Identifier*

1. If the [StringValue](#) of *Identifier* is "arguments", return **true**.
2. Return **false**.

*FunctionDeclaration* :

```
function BindingIdentifier ( FormalParameters ) { FunctionBody }
function ( FormalParameters ) { FunctionBody }
```

*FunctionExpression* :

```
function BindingIdentifieropt ( FormalParameters ) { FunctionBody }
```

*GeneratorDeclaration* :

```
function * BindingIdentifier ( FormalParameters ) { GeneratorBody }
function * ( FormalParameters ) { GeneratorBody }
```

*GeneratorExpression* :

```
function * BindingIdentifieropt ( FormalParameters ) { GeneratorBody }
```

*AsyncGeneratorDeclaration* :

```
async function * BindingIdentifier ( FormalParameters ) { AsyncGeneratorBody }
async function * ( FormalParameters ) { AsyncGeneratorBody }
```

*AsyncGeneratorExpression* :

```
async function * BindingIdentifieropt ( FormalParameters ) { AsyncGeneratorBody }
```

*AsyncFunctionDeclaration* :

```
async function BindingIdentifier ( FormalParameters ) { AsyncFunctionBody }
async function ( FormalParameters ) { AsyncFunctionBody }
```

*AsyncFunctionExpression* :

```
async function BindingIdentifieropt ( FormalParameters ) { AsyncFunctionBody }
```

1. Return **false**.

*MethodDefinition* :

```
ClassElementName ( UniqueFormalParameters ) { FunctionBody }
get ClassElementName ( ) { FunctionBody }
set ClassElementName ( PropertySetParameterList ) { FunctionBody }
```

*GeneratorMethod* :

```
* ClassElementName ( UniqueFormalParameters ) { GeneratorBody }
```

*AsyncGeneratorMethod* :

```
async * ClassElementName ( UniqueFormalParameters ) { AsyncGeneratorBody }
```

*AsyncMethod* :

```
async ClassElementName ( UniqueFormalParameters ) { AsyncFunctionBody }
```

1. Return [ContainsArguments](#) of *ClassElementName*.

### 15.7.10 Runtime Semantics: ClassFieldDefinitionEvaluation

The *syntax-directed operation* `ClassFieldDefinitionEvaluation` takes argument *homeObject* (an Object) and returns either a *normal completion* containing a *ClassFieldDefinition Record* or an *abrupt completion*. It is defined piecewise over the following productions:

*FieldDefinition* : *ClassElementName* *Initializer*<sub>opt</sub>

1. Let *name* be ? *Evaluation* of *ClassElementName*.
2. If *Initializer*<sub>opt</sub> is present, then
  - a. Let *formalParameterList* be an instance of the production *FormalParameters* : [empty] .
  - b. Let *env* be the *LexicalEnvironment* of the *running execution context*.
  - c. Let *privateEnv* be the *running execution context*'s *PrivateEnvironment*.
  - d. Let *sourceText* be the empty sequence of Unicode code points.
  - e. Let *initializer* be *OrdinaryFunctionCreate*(%Function.prototype%, *sourceText*, *formalParameterList*, *Initializer*, non-lexical-this, *env*, *privateEnv*).
  - f. Perform *MakeMethod*(*initializer*, *homeObject*).
  - g. Set *initializer*.[[ClassFieldInitializerName]] to *name*.
3. Else,
  - a. Let *initializer* be empty.
4. Return the *ClassFieldDefinition Record* { [[Name]]: *name*, [[Initializer]]: *initializer* }.

**NOTE** The function created for *initializer* is never directly accessible to ECMAScript code.

### 15.7.11 Runtime Semantics: ClassStaticBlockDefinitionEvaluation

The *syntax-directed operation* `ClassStaticBlockDefinitionEvaluation` takes argument *homeObject* (an Object) and returns a *ClassStaticBlockDefinition Record*. It is defined piecewise over the following productions:

*ClassStaticBlock* : **static** { *ClassStaticBlockBody* }

1. Let *lex* be the *running execution context*'s *LexicalEnvironment*.
2. Let *privateEnv* be the *running execution context*'s *PrivateEnvironment*.
3. Let *sourceText* be the empty sequence of Unicode code points.
4. Let *formalParameters* be an instance of the production *FormalParameters* : [empty] .
5. Let *bodyFunction* be *OrdinaryFunctionCreate*(%Function.prototype%, *sourceText*, *formalParameters*, *ClassStaticBlockBody*, non-lexical-this, *lex*, *privateEnv*).
6. Perform *MakeMethod*(*bodyFunction*, *homeObject*).
7. Return the *ClassStaticBlockDefinition Record* { [[BodyFunction]]: *bodyFunction* }.

**NOTE** The function *bodyFunction* is never directly accessible to ECMAScript code.

### 15.7.12 Runtime Semantics: EvaluateClassStaticBlockBody

The *syntax-directed operation* `EvaluateClassStaticBlockBody` takes argument *functionObject* (a function object) and returns either a *normal completion* containing an *ECMAScript language value* or an *abrupt completion*. It is defined piecewise over the following productions:

*ClassStaticBlockBody* : *ClassStaticBlockStatementList*

1. Perform ? *FunctionDeclarationInstantiation*(*functionObject*, « »).

2. Return ? [Evaluation](#) of *ClassStaticBlockStatementList*.

### 15.7.13 Runtime Semantics: *ClassElementEvaluation*

The [syntax-directed operation](#) *ClassElementEvaluation* takes argument *object* (an Object) and returns either a [normal completion](#) containing either a [ClassFieldDefinition Record](#), a [ClassStaticBlockDefinition Record](#), a [PrivateElement](#), or unused, or an [abrupt completion](#). It is defined piecewise over the following productions:

*ClassElement* :

*FieldDefinition* ;  
**static** *FieldDefinition* ;

1. Return ? [ClassFieldDefinitionEvaluation](#) of *FieldDefinition* with argument *object*.

*ClassElement* :

*MethodDefinition*  
**static** *MethodDefinition*

1. Return ? [MethodDefinitionEvaluation](#) of *MethodDefinition* with arguments *object* and **false**.

*ClassElement* : *ClassStaticBlock*

1. Return [ClassStaticBlockDefinitionEvaluation](#) of *ClassStaticBlock* with argument *object*.

*ClassElement* : ;

1. Return unused.

### 15.7.14 Runtime Semantics: *ClassDefinitionEvaluation*

The [syntax-directed operation](#) *ClassDefinitionEvaluation* takes arguments *classBinding* (a String or **undefined**) and *className* (a [property key](#) or a [Private Name](#)) and returns either a [normal completion](#) containing a [function object](#) or an [abrupt completion](#).

#### NOTE

For ease of specification, private methods and accessors are included alongside private fields in the `[[PrivateElements]]` slot of class instances. However, any given object has either all or none of the private methods and accessors defined by a given class. This feature has been designed so that implementations may choose to implement private methods and accessors using a strategy which does not require tracking each method or accessor individually.

For example, an implementation could directly associate instance private methods with their corresponding [Private Name](#) and track, for each object, which class [constructors](#) have run with that object as their **this** value. Looking up an instance private method on an object then consists of checking that the class [constructor](#) which defines the method has been used to initialize the object, then returning the method associated with the [Private Name](#).

This differs from private fields: because field initializers can throw during class instantiation, an individual object may have some proper subset of the private fields of a given class, and so private fields must in general be tracked individually.

It is defined piecewise over the following productions:

*ClassTail* : *ClassHeritage*<sub>opt</sub> { *ClassBody*<sub>opt</sub> }

1. Let *env* be the LexicalEnvironment of the running execution context.
2. Let *classEnv* be `NewDeclarativeEnvironment(env)`.
3. If *classBinding* is not **undefined**, then
  - a. Perform `! classEnv.CreateImmutableBinding(classBinding, true)`.
4. Let *outerPrivateEnvironment* be the running execution context's PrivateEnvironment.
5. Let *classPrivateEnvironment* be `NewPrivateEnvironment(outerPrivateEnvironment)`.
6. If *ClassBody*<sub>opt</sub> is present, then
  - a. For each String *dn* of the PrivateBoundIdentifiers of *ClassBody*<sub>opt</sub>, do
    - i. If *classPrivateEnvironment*.[[Names]] contains a Private Name *pn* such that *pn*.[[Description]] is *dn*, then
      1. **Assert**: This is only possible for getter/setter pairs.
    - ii. Else,
      1. Let *name* be a new Private Name whose [[Description]] is *dn*.
      2. Append *name* to *classPrivateEnvironment*.[[Names]].
7. If *ClassHeritage*<sub>opt</sub> is not present, then
  - a. Let *protoParent* be `%Object.prototype%`.
  - b. Let *constructorParent* be `%Function.prototype%`.
8. Else,
  - a. Set the running execution context's LexicalEnvironment to *classEnv*.
  - b. NOTE: The running execution context's PrivateEnvironment is *outerPrivateEnvironment* when evaluating *ClassHeritage*.
  - c. Let *superclassRef* be `Completion(Evaluation of ClassHeritage)`.
  - d. Set the running execution context's LexicalEnvironment to *env*.
  - e. Let *superclass* be `? GetValue(? superclassRef)`.
  - f. If *superclass* is **null**, then
    - i. Let *protoParent* be **null**.
    - ii. Let *constructorParent* be `%Function.prototype%`.
  - g. Else if `IsConstructor(superclass)` is **false**, throw a **TypeError** exception.
  - h. Else,
    - i. Let *protoParent* be `? Get(superclass, "prototype")`.
    - ii. If *protoParent* is not an Object and *protoParent* is not **null**, throw a **TypeError** exception.
    - iii. Let *constructorParent* be *superclass*.
9. Let *proto* be `OrdinaryObjectCreate(protoParent)`.
10. If *ClassBody*<sub>opt</sub> is not present, let *constructor* be empty.
11. Else, let *constructor* be `ConstructorMethod` of *ClassBody*.
12. Set the running execution context's LexicalEnvironment to *classEnv*.
13. Set the running execution context's PrivateEnvironment to *classPrivateEnvironment*.
14. If *constructor* is empty, then
  - a. Let *defaultConstructor* be a new **Abstract Closure** with no parameters that captures nothing and performs the following steps when called:
    - i. Let *args* be the **List** of arguments that was passed to this function by `[[Call]]` or `[[Construct]]`.
    - ii. If `NewTarget` is **undefined**, throw a **TypeError** exception.
    - iii. Let *F* be the **active function object**.
    - iv. If *F*.[[ConstructorKind]] is derived, then
      1. NOTE: This branch behaves similarly to `constructor(...args) { super(...args); }`. The most notable distinction is that while the aforementioned **ECMAScript source text** observably calls the `@@iterator` method on `%Array.prototype%`, this function does not.
      2. Let *func* be `! F.[[GetPrototypeOf]]()`.

3. If `IsConstructor(func)` is **false**, throw a **TypeError** exception.
  4. Let *result* be ? `Construct(func, args, NewTarget)`.
  - v. Else,
    1. NOTE: This branch behaves similarly to `constructor() {}`.
    2. Let *result* be ? `OrdinaryCreateFromConstructor(NewTarget, "%Object.prototype%")`.
  - vi. Perform ? `InitializeInstanceElements(result, F)`.
  - vii. Return *result*.
  - b. Let *F* be `CreateBuiltinFunction(defaultConstructor, 0, className, « [[ConstructorKind]], [[SourceText]] », the current Realm Record, constructorParent)`.
15. Else,
- a. Let *constructorInfo* be ! `DefineMethod` of *constructor* with arguments *proto* and *constructorParent*.
  - b. Let *F* be *constructorInfo*.[[Closure]].
  - c. Perform `MakeClassConstructor(F)`.
  - d. Perform `SetFunctionName(F, className)`.
16. Perform `MakeConstructor(F, false, proto)`.
17. If *ClassHeritage<sub>opt</sub>* is present, set *F*.[[ConstructorKind]] to derived.
18. Perform `CreateMethodProperty(proto, "constructor", F)`.
19. If *ClassBody<sub>opt</sub>* is not present, let *elements* be a new empty List.
20. Else, let *elements* be `NonConstructorElements` of *ClassBody*.
21. Let *instancePrivateMethods* be a new empty List.
22. Let *staticPrivateMethods* be a new empty List.
23. Let *instanceFields* be a new empty List.
24. Let *staticElements* be a new empty List.
25. For each *ClassElement e* of *elements*, do
- a. If `IsStatic` of *e* is **false**, then
    - i. Let *element* be `Completion(ClassElementEvaluation` of *e* with argument *proto*).
  - b. Else,
    - i. Let *element* be `Completion(ClassElementEvaluation` of *e* with argument *F*).
  - c. If *element* is an abrupt completion, then
    - i. Set the running execution context's LexicalEnvironment to *env*.
    - ii. Set the running execution context's PrivateEnvironment to *outerPrivateEnvironment*.
    - iii. Return ? *element*.
  - d. Set *element* to *element*.[[Value]].
  - e. If *element* is a `PrivateElement`, then
    - i. Assert: *element*.[[Kind]] is either method or accessor.
    - ii. If `IsStatic` of *e* is **false**, let *container* be *instancePrivateMethods*.
    - iii. Else, let *container* be *staticPrivateMethods*.
    - iv. If *container* contains a `PrivateElement pe` such that *pe*.[[Key]] is *element*.[[Key]], then
      1. Assert: *element*.[[Kind]] and *pe*.[[Kind]] are both accessor.
      2. If *element*.[[Get]] is **undefined**, then
        - a. Let *combined* be `PrivateElement` { [[Key]]: *element*.[[Key]], [[Kind]]: accessor, [[Get]]: *pe*.[[Get]], [[Set]]: *element*.[[Set]] }.
      3. Else,
        - a. Let *combined* be `PrivateElement` { [[Key]]: *element*.[[Key]], [[Kind]]: accessor, [[Get]]: *element*.[[Get]], [[Set]]: *pe*.[[Set]] }.
      4. Replace *pe* in *container* with *combined*.
    - v. Else,
      1. Append *element* to *container*.

- f. Else if *element* is a [ClassFieldDefinition Record](#), then
  - i. If `IsStatic` of *e* is **false**, append *element* to *instanceFields*.
  - ii. Else, append *element* to *staticElements*.
- g. Else if *element* is a [ClassStaticBlockDefinition Record](#), then
  - i. Append *element* to *staticElements*.
- 26. Set the [running execution context](#)'s `LexicalEnvironment` to *env*.
- 27. If *classBinding* is not **undefined**, then
  - a. Perform ! *classEnv*.`InitializeBinding(classBinding, F)`.
- 28. Set *F*.`[[PrivateMethods]]` to *instancePrivateMethods*.
- 29. Set *F*.`[[Fields]]` to *instanceFields*.
- 30. For each [PrivateElement method](#) of *staticPrivateMethods*, do
  - a. Perform ! `PrivateMethodOrAccessorAdd(F, method)`.
- 31. For each element *elementRecord* of *staticElements*, do
  - a. If *elementRecord* is a [ClassFieldDefinition Record](#), then
    - i. Let *result* be `Completion(DefineField(F, elementRecord))`.
  - b. Else,
    - i. **Assert**: *elementRecord* is a [ClassStaticBlockDefinition Record](#).
    - ii. Let *result* be `Completion(Call(elementRecord. [[BodyFunction]], F))`.
  - c. If *result* is an [abrupt completion](#), then
    - i. Set the [running execution context](#)'s `PrivateEnvironment` to *outerPrivateEnvironment*.
    - ii. Return ? *result*.
- 32. Set the [running execution context](#)'s `PrivateEnvironment` to *outerPrivateEnvironment*.
- 33. Return *F*.

### 15.7.15 Runtime Semantics: BindingClassDeclarationEvaluation

The [syntax-directed operation](#) `BindingClassDeclarationEvaluation` takes no arguments and returns either a [normal completion](#) containing a [function object](#) or an [abrupt completion](#). It is defined piecewise over the following productions:

*ClassDeclaration* : **class** *BindingIdentifier* *ClassTail*

1. Let *className* be [StringValue](#) of *BindingIdentifier*.
2. Let *value* be ? [ClassDefinitionEvaluation](#) of *ClassTail* with arguments *className* and *className*.
3. Set *value*.`[[SourceText]]` to the [source text matched by](#) *ClassDeclaration*.
4. Let *env* be the [running execution context](#)'s `LexicalEnvironment`.
5. Perform ? `InitializeBoundName(className, value, env)`.
6. Return *value*.

*ClassDeclaration* : **class** *ClassTail*

1. Let *value* be ? [ClassDefinitionEvaluation](#) of *ClassTail* with arguments **undefined** and **"default"**.
2. Set *value*.`[[SourceText]]` to the [source text matched by](#) *ClassDeclaration*.
3. Return *value*.

**NOTE** *ClassDeclaration* : **class** *ClassTail* only occurs as part of an *ExportDeclaration* and establishing its binding is handled as part of the evaluation action for that production. See [16.2.3.7](#).

### 15.7.16 Runtime Semantics: Evaluation

*ClassDeclaration* : **class** *BindingIdentifier* *ClassTail*



1. Perform ? [BindingClassDeclarationEvaluation](#) of this *ClassDeclaration*.
2. Return empty.

**NOTE** *ClassDeclaration* : **class** *ClassTail* only occurs as part of an *ExportDeclaration* and is never directly evaluated.

*ClassExpression* : **class** *ClassTail*

1. Let *value* be ? [ClassDefinitionEvaluation](#) of *ClassTail* with arguments **undefined** and "".
2. Set *value*.[[SourceText]] to the [source text matched by](#) *ClassExpression*.
3. Return *value*.

*ClassExpression* : **class** *BindingIdentifier* *ClassTail*

1. Let *className* be [StringValue](#) of *BindingIdentifier*.
2. Let *value* be ? [ClassDefinitionEvaluation](#) of *ClassTail* with arguments *className* and *className*.
3. Set *value*.[[SourceText]] to the [source text matched by](#) *ClassExpression*.
4. Return *value*.

*ClassElementName* : *PrivateIdentifier*

1. Let *privateIdentifier* be [StringValue](#) of *PrivateIdentifier*.
2. Let *privateEnvRec* be the [running execution context](#)'s [PrivateEnvironment](#).
3. Let *names* be *privateEnvRec*.[[Names]].
4. **Assert**: Exactly one element of *names* is a [Private Name](#) whose [[Description]] is *privateIdentifier*.
5. Let *privateName* be the [Private Name](#) in *names* whose [[Description]] is *privateIdentifier*.
6. Return *privateName*.

*ClassStaticBlockStatementList* : [empty]

1. Return **undefined**.

## 15.8 Async Function Definitions

### Syntax

```

AsyncFunctionDeclaration[Yield, Await, Default] :
    async [no LineTerminator here] function BindingIdentifier[?Yield, ?Await] (
        FormalParameters[~Yield, +Await] ) { AsyncFunctionBody }
    [+Default] async [no LineTerminator here] function (
        FormalParameters[~Yield, +Await] ) { AsyncFunctionBody }

```

```

AsyncFunctionExpression :
    async [no LineTerminator here] function BindingIdentifier[~Yield, +Await] opt (
        FormalParameters[~Yield, +Await] ) { AsyncFunctionBody }

```

```

AsyncMethod[Yield, Await] :
    async [no LineTerminator here] ClassElementName[?Yield, ?Await] (
        UniqueFormalParameters[~Yield, +Await] ) { AsyncFunctionBody }

```

```

AsyncFunctionBody :
    FunctionBody[~Yield, +Await]

```

*AwaitExpression*<sub>[Yield]</sub> :  
**await** *UnaryExpression*<sub>[?Yield, +Await]</sub>

NOTE 1 **await** is parsed as a **keyword** of an *AwaitExpression* when the <sub>[Await]</sub> parameter is present. The <sub>[Await]</sub> parameter is present in the top level of the following contexts, although the parameter may be absent in some contexts depending on the nonterminals, such as *FunctionBody*:

- In an *AsyncFunctionBody*.
- In the *FormalParameters* of an *AsyncFunctionDeclaration*, *AsyncFunctionExpression*, *AsyncGeneratorDeclaration*, or *AsyncGeneratorExpression*. *AwaitExpression* in this position is a Syntax error via **static semantics**.
- In a *Module*.

When *Script* is the syntactic **goal symbol**, **await** may be parsed as an identifier when the <sub>[Await]</sub> parameter is absent. This includes the following contexts:

- Anywhere outside of an *AsyncFunctionBody* or *FormalParameters* of an *AsyncFunctionDeclaration*, *AsyncFunctionExpression*, *AsyncGeneratorDeclaration*, or *AsyncGeneratorExpression*.
- In the *BindingIdentifier* of a *FunctionExpression*, *GeneratorExpression*, or *AsyncGeneratorExpression*.

NOTE 2 Unlike *YieldExpression*, it is a Syntax Error to omit the operand of an *AwaitExpression*. You must await something.

### 15.8.1 Static Semantics: Early Errors

*AsyncMethod* : **async** *ClassElementName* ( *UniqueFormalParameters* ) { *AsyncFunctionBody* }

- It is a Syntax Error if *FunctionBodyContainsUseStrict* of *AsyncFunctionBody* is **true** and *IsSimpleParameterList* of *UniqueFormalParameters* is **false**.
- It is a Syntax Error if *HasDirectSuper* of *AsyncMethod* is **true**.
- It is a Syntax Error if *UniqueFormalParameters* *Contains AwaitExpression* is **true**.
- It is a Syntax Error if any element of the *BoundNames* of *UniqueFormalParameters* also occurs in the *LexicallyDeclaredNames* of *AsyncFunctionBody*.

*AsyncFunctionDeclaration* :

**async function** *BindingIdentifier* ( *FormalParameters* ) { *AsyncFunctionBody* }  
**async function** ( *FormalParameters* ) { *AsyncFunctionBody* }

*AsyncFunctionExpression* :

**async function** *BindingIdentifier*<sub>opt</sub> ( *FormalParameters* ) { *AsyncFunctionBody* }

- It is a Syntax Error if *FunctionBodyContainsUseStrict* of *AsyncFunctionBody* is **true** and *IsSimpleParameterList* of *FormalParameters* is **false**.
- It is a Syntax Error if *FormalParameters* *Contains AwaitExpression* is **true**.
- If the **source text matched by** *FormalParameters* is **strict mode code**, the Early Error rules for *UniqueFormalParameters* : *FormalParameters* are applied.
- If *BindingIdentifier* is present and the **source text matched by** *BindingIdentifier* is **strict mode code**, it is a Syntax Error if the *StringValue* of *BindingIdentifier* is either **"eval"** or **"arguments"**.
- It is a Syntax Error if any element of the *BoundNames* of *FormalParameters* also occurs in the *LexicallyDeclaredNames* of *AsyncFunctionBody*.
- It is a Syntax Error if *FormalParameters* *Contains SuperProperty* is **true**.
- It is a Syntax Error if *AsyncFunctionBody* *Contains SuperProperty* is **true**.
- It is a Syntax Error if *FormalParameters* *Contains SuperCall* is **true**.
- It is a Syntax Error if *AsyncFunctionBody* *Contains SuperCall* is **true**.

## 15.8.2 Runtime Semantics: InstantiateAsyncFunctionObject

The [syntax-directed operation](#) `InstantiateAsyncFunctionObject` takes arguments `env` (an [Environment Record](#)) and `privateEnv` (a [PrivateEnvironment Record](#) or `null`) and returns a [function object](#). It is defined piecewise over the following productions:

*AsyncFunctionDeclaration* : **async function** *BindingIdentifier* ( *FormalParameters* ) { *AsyncFunctionBody* }

1. Let `name` be [StringValue](#) of *BindingIdentifier*.
2. Let `sourceText` be the [source text matched by](#) *AsyncFunctionDeclaration*.
3. Let `F` be [OrdinaryFunctionCreate](#)(%[AsyncFunction.prototype](#)%, `sourceText`, *FormalParameters*, *AsyncFunctionBody*, non-lexical-this, `env`, `privateEnv`).
4. Perform [SetFunctionName](#)(`F`, `name`).
5. Return `F`.

*AsyncFunctionDeclaration* : **async function** ( *FormalParameters* ) { *AsyncFunctionBody* }

1. Let `sourceText` be the [source text matched by](#) *AsyncFunctionDeclaration*.
2. Let `F` be [OrdinaryFunctionCreate](#)(%[AsyncFunction.prototype](#)%, `sourceText`, *FormalParameters*, *AsyncFunctionBody*, non-lexical-this, `env`, `privateEnv`).
3. Perform [SetFunctionName](#)(`F`, "default").
4. Return `F`.

## 15.8.3 Runtime Semantics: InstantiateAsyncFunctionExpression

The [syntax-directed operation](#) `InstantiateAsyncFunctionExpression` takes optional argument `name` (a [property key](#) or a [Private Name](#)) and returns a [function object](#). It is defined piecewise over the following productions:

*AsyncFunctionExpression* : **async function** ( *FormalParameters* ) { *AsyncFunctionBody* }

1. If `name` is not present, set `name` to "".
2. Let `env` be the [LexicalEnvironment](#) of the [running execution context](#).
3. Let `privateEnv` be the [running execution context](#)'s [PrivateEnvironment](#).
4. Let `sourceText` be the [source text matched by](#) *AsyncFunctionExpression*.
5. Let `closure` be [OrdinaryFunctionCreate](#)(%[AsyncFunction.prototype](#)%, `sourceText`, *FormalParameters*, *AsyncFunctionBody*, non-lexical-this, `env`, `privateEnv`).
6. Perform [SetFunctionName](#)(`closure`, `name`).
7. Return `closure`.

*AsyncFunctionExpression* : **async function** *BindingIdentifier* ( *FormalParameters* ) { *AsyncFunctionBody* }

1. [Assert](#): `name` is not present.
2. Set `name` to [StringValue](#) of *BindingIdentifier*.
3. Let `outerEnv` be the [LexicalEnvironment](#) of the [running execution context](#).
4. Let `funcEnv` be [NewDeclarativeEnvironment](#)(`outerEnv`).
5. Perform ! `funcEnv`.[CreateImmutableBinding](#)(`name`, `false`).
6. Let `privateEnv` be the [running execution context](#)'s [PrivateEnvironment](#).
7. Let `sourceText` be the [source text matched by](#) *AsyncFunctionExpression*.
8. Let `closure` be [OrdinaryFunctionCreate](#)(%[AsyncFunction.prototype](#)%, `sourceText`, *FormalParameters*, *AsyncFunctionBody*, non-lexical-this, `funcEnv`, `privateEnv`).

9. Perform `SetFunctionName(closure, name)`.
10. Perform `! funcEnv.InitializeBinding(name, closure)`.
11. Return *closure*.

**NOTE** The *BindingIdentifier* in an *AsyncFunctionExpression* can be referenced from inside the *AsyncFunctionExpression*'s *AsyncFunctionBody* to allow the function to call itself recursively. However, unlike in a *FunctionDeclaration*, the *BindingIdentifier* in a *AsyncFunctionExpression* cannot be referenced from and does not affect the scope enclosing the *AsyncFunctionExpression*.

### 15.8.4 Runtime Semantics: EvaluateAsyncFunctionBody

The *syntax-directed operation* `EvaluateAsyncFunctionBody` takes arguments *functionObject* (a *function object*) and *argumentsList* (a *List* of *ECMAScript language values*) and returns a *return completion*. It is defined piecewise over the following productions:

*AsyncFunctionBody* : *FunctionBody*

1. Let *promiseCapability* be `! NewPromiseCapability(%Promise%)`.
2. Let *declResult* be `Completion(FunctionDeclarationInstantiation(functionObject, argumentsList))`.
3. If *declResult* is an *abrupt completion*, then
  - a. Perform `! Call(promiseCapability.[[Reject]], undefined, « declResult.[[Value]] »)`.
4. Else,
  - a. Perform `AsyncFunctionStart(promiseCapability, FunctionBody)`.
5. Return *Completion Record* { [[Type]]: `return`, [[Value]]: *promiseCapability*.[[Promise]], [[Target]]: `empty` }.

### 15.8.5 Runtime Semantics: Evaluation

*AsyncFunctionExpression* :  
**async function** *BindingIdentifier*<sub>opt</sub> ( *FormalParameters* ) { *AsyncFunctionBody* }

1. Return `InstantiateAsyncFunctionExpression` of *AsyncFunctionExpression*.

*AwaitExpression* : **await** *UnaryExpression*

1. Let *exprRef* be `? Evaluation` of *UnaryExpression*.
2. Let *value* be `? GetValue(exprRef)`.
3. Return `? Await(value)`.

## 15.9 Async Arrow Function Definitions

### Syntax

*AsyncArrowFunction*<sub>[In, Yield, Await]</sub> :  
**async** [no *LineTerminator* here] *AsyncArrowBindingIdentifier*<sub>[?Yield]</sub> [no *LineTerminator* here] => *AsyncConciseBody*<sub>[?In]</sub>  
*CoverCallExpressionAndAsyncArrowHead*<sub>[?Yield, ?Await]</sub> [no *LineTerminator* here] =>  
*AsyncConciseBody*<sub>[?In]</sub>

*AsyncConciseBody*<sub>[In]</sub> :  
 [lookahead ≠ {] *ExpressionBody*<sub>[?In, +Await]</sub>

```

    { AsyncFunctionBody }

    AsyncArrowBindingIdentifier[Yield] :
        BindingIdentifier[?Yield, +Await]

    CoverCallExpressionAndAsyncArrowHead[Yield, Await] :
        MemberExpression[?Yield, ?Await] Arguments[?Yield, ?Await]

```

## Supplemental Syntax

When processing an instance of the production

*AsyncArrowFunction* : *CoverCallExpressionAndAsyncArrowHead* => *AsyncConciseBody*  
the interpretation of *CoverCallExpressionAndAsyncArrowHead* is refined using the following grammar:

```

    AsyncArrowHead :
        async [no LineTerminator here] ArrowFormalParameters[~Yield, +Await]

```

### 15.9.1 Static Semantics: Early Errors

*AsyncArrowFunction* : **async** *AsyncArrowBindingIdentifier* => *AsyncConciseBody*

- It is a Syntax Error if any element of the [BoundNames](#) of *AsyncArrowBindingIdentifier* also occurs in the [LexicallyDeclaredNames](#) of *AsyncConciseBody*.

*AsyncArrowFunction* : *CoverCallExpressionAndAsyncArrowHead* => *AsyncConciseBody*

- CoverCallExpressionAndAsyncArrowHead* **must cover** an *AsyncArrowHead*.
- It is a Syntax Error if *CoverCallExpressionAndAsyncArrowHead* [Contains YieldExpression](#) is **true**.
- It is a Syntax Error if *CoverCallExpressionAndAsyncArrowHead* [Contains AwaitExpression](#) is **true**.
- It is a Syntax Error if any element of the [BoundNames](#) of *CoverCallExpressionAndAsyncArrowHead* also occurs in the [LexicallyDeclaredNames](#) of *AsyncConciseBody*.
- It is a Syntax Error if [AsyncConciseBodyContainsUseStrict](#) of *AsyncConciseBody* is **true** and [IsSimpleParameterList](#) of *CoverCallExpressionAndAsyncArrowHead* is **false**.

### 15.9.2 Static Semantics: AsyncConciseBodyContainsUseStrict

The [syntax-directed operation](#) *AsyncConciseBodyContainsUseStrict* takes no arguments and returns a Boolean. It is defined piecewise over the following productions:

*AsyncConciseBody* : *ExpressionBody*

- Return **false**.

*AsyncConciseBody* : { *AsyncFunctionBody* }

- Return [FunctionBodyContainsUseStrict](#) of *AsyncFunctionBody*.

### 15.9.3 Runtime Semantics: EvaluateAsyncConciseBody

The [syntax-directed operation](#) *EvaluateAsyncConciseBody* takes arguments *functionObject* (a [function object](#)) and *argumentsList* (a [List](#) of [ECMAScript language values](#)) and returns a [return completion](#). It is defined piecewise over the following productions:

*AsyncConciseBody* : *ExpressionBody*

1. Let *promiseCapability* be ! NewPromiseCapability(%Promise%).
2. Let *declResult* be Completion(FunctionDeclarationInstantiation(*functionObject*, *argumentsList*)).
3. If *declResult* is an abrupt completion, then
  - a. Perform ! Call(*promiseCapability*.[[Reject]], **undefined**, « *declResult*.[[Value]] »).
4. Else,
  - a. Perform AsyncFunctionStart(*promiseCapability*, *ExpressionBody*).
5. Return Completion Record { [[Type]]: return, [[Value]]: *promiseCapability*.[[Promise]], [[Target]]: empty }.

### 15.9.4 Runtime Semantics: InstantiateAsyncArrowFunctionExpression

The [syntax-directed operation](#) `InstantiateAsyncArrowFunctionExpression` takes optional argument *name* (a [property key](#) or a [Private Name](#)) and returns a [function object](#). It is defined piecewise over the following productions:

*AsyncArrowFunction* : **async** *AsyncArrowBindingIdentifier* => *AsyncConciseBody*

1. If *name* is not present, set *name* to "".
2. Let *env* be the LexicalEnvironment of the [running execution context](#).
3. Let *privateEnv* be the [running execution context](#)'s PrivateEnvironment.
4. Let *sourceText* be the [source text matched by AsyncArrowFunction](#).
5. Let *parameters* be *AsyncArrowBindingIdentifier*.
6. Let *closure* be OrdinaryFunctionCreate(%AsyncFunction.prototype%, *sourceText*, *parameters*, *AsyncConciseBody*, lexical-this, *env*, *privateEnv*).
7. Perform SetFunctionName(*closure*, *name*).
8. Return *closure*.

*AsyncArrowFunction* : *CoverCallExpressionAndAsyncArrowHead* => *AsyncConciseBody*

1. If *name* is not present, set *name* to "".
2. Let *env* be the LexicalEnvironment of the [running execution context](#).
3. Let *privateEnv* be the [running execution context](#)'s PrivateEnvironment.
4. Let *sourceText* be the [source text matched by AsyncArrowFunction](#).
5. Let *head* be the *AsyncArrowHead* that is [covered](#) by *CoverCallExpressionAndAsyncArrowHead*.
6. Let *parameters* be the *ArrowFormalParameters* of *head*.
7. Let *closure* be OrdinaryFunctionCreate(%AsyncFunction.prototype%, *sourceText*, *parameters*, *AsyncConciseBody*, lexical-this, *env*, *privateEnv*).
8. Perform SetFunctionName(*closure*, *name*).
9. Return *closure*.

### 15.9.5 Runtime Semantics: Evaluation

*AsyncArrowFunction* :

**async** *AsyncArrowBindingIdentifier* => *AsyncConciseBody*  
*CoverCallExpressionAndAsyncArrowHead* => *AsyncConciseBody*

1. Return [InstantiateAsyncArrowFunctionExpression](#) of *AsyncArrowFunction*.

## 15.10 Tail Position Calls

### 15.10.1 Static Semantics: `IsInTailPosition` ( *call* )

The abstract operation `IsInTailPosition` takes argument *call* (a *CallExpression Parse Node*, a *MemberExpression Parse Node*, or an *OptionalChain Parse Node*) and returns a Boolean. It performs the following steps when called:

1. If the *source text matched by call* is *non-strict code*, return **false**.
2. If *call* is not contained within a *FunctionBody*, a *ConciseBody*, or an *AsyncConciseBody*, return **false**.
3. Let *body* be the *FunctionBody*, *ConciseBody*, or *AsyncConciseBody* that most closely contains *call*.
4. If *body* is the *FunctionBody* of a *GeneratorBody*, return **false**.
5. If *body* is the *FunctionBody* of an *AsyncFunctionBody*, return **false**.
6. If *body* is the *FunctionBody* of an *AsyncGeneratorBody*, return **false**.
7. If *body* is an *AsyncConciseBody*, return **false**.
8. Return the result of `HasCallInTailPosition` of *body* with argument *call*.

**NOTE** Tail Position calls are only defined in *strict mode code* because of a common non-standard language extension (see 10.2.4) that enables observation of the chain of caller contexts.

### 15.10.2 Static Semantics: `HasCallInTailPosition`

The *syntax-directed operation* `HasCallInTailPosition` takes argument *call* (a *CallExpression Parse Node*, a *MemberExpression Parse Node*, or an *OptionalChain Parse Node*) and returns a Boolean.

**NOTE 1** *call* is a *Parse Node* that represents a specific range of source text. When the following algorithms compare *call* to another *Parse Node*, it is a test of whether they represent the same source text.

**NOTE 2** A potential tail position call that is immediately followed by return `GetValue` of the call result is also a possible tail position call. A function call cannot return a *Reference Record*, so such a `GetValue` operation will always return the same value as the actual function call result.

It is defined piecewise over the following productions:

*StatementList* : *StatementList StatementListItem*

1. Let *has* be `HasCallInTailPosition` of *StatementList* with argument *call*.
2. If *has* is **true**, return **true**.
3. Return `HasCallInTailPosition` of *StatementListItem* with argument *call*.

*FunctionStatementList* :

[empty]

*StatementListItem* :

*Declaration*

*Statement* :

*VariableStatement*  
*EmptyStatement*  
*ExpressionStatement*  
*ContinueStatement*  
*BreakStatement*  
*ThrowStatement*

*DebuggerStatement*

*Block* :

{ }

*ReturnStatement* :

**return** ;

*LabelledItem* :

*FunctionDeclaration*

*ForInOfStatement* :

**for** ( *LeftHandSideExpression* **of** *AssignmentExpression* ) *Statement*

**for** ( **var** *ForBinding* **of** *AssignmentExpression* ) *Statement*

**for** ( *ForDeclaration* **of** *AssignmentExpression* ) *Statement*

*CaseBlock* :

{ }

1. Return **false**.

*IfStatement* : **if** ( *Expression* ) *Statement* **else** *Statement*

1. Let *has* be [HasCallInTailPosition](#) of the first *Statement* with argument *call*.
2. If *has* is **true**, return **true**.
3. Return [HasCallInTailPosition](#) of the second *Statement* with argument *call*.

*IfStatement* :

**if** ( *Expression* ) *Statement*

*DoWhileStatement* :

**do** *Statement* **while** ( *Expression* ) ;

*WhileStatement* :

**while** ( *Expression* ) *Statement*

*ForStatement* :

**for** ( *Expression*<sub>opt</sub> ; *Expression*<sub>opt</sub> ; *Expression*<sub>opt</sub> ) *Statement*

**for** ( **var** *VariableDeclarationList* ; *Expression*<sub>opt</sub> ; *Expression*<sub>opt</sub> ) *Statement*

**for** ( *LexicalDeclaration* *Expression*<sub>opt</sub> ; *Expression*<sub>opt</sub> ) *Statement*

*ForInOfStatement* :

**for** ( *LeftHandSideExpression* **in** *Expression* ) *Statement*

**for** ( **var** *ForBinding* **in** *Expression* ) *Statement*

**for** ( *ForDeclaration* **in** *Expression* ) *Statement*

*WithStatement* :

**with** ( *Expression* ) *Statement*

1. Return [HasCallInTailPosition](#) of *Statement* with argument *call*.

*LabelledStatement* :

*LabelIdentifier* : *LabelledItem*

1. Return [HasCallInTailPosition](#) of *LabelledItem* with argument *call*.

*ReturnStatement* : **return** *Expression* ;

1. Return [HasCallInTailPosition](#) of *Expression* with argument *call*.

*SwitchStatement* : **switch** ( *Expression* ) *CaseBlock*

1. Return [HasCallInTailPosition](#) of *CaseBlock* with argument *call*.

*CaseBlock* : { *CaseClauses*<sub>opt</sub> *DefaultClause* *CaseClauses*<sub>opt</sub> }

1. Let *has* be **false**.



2. If the first *CaseClauses* is present, let *has* be *HasCallInTailPosition* of the first *CaseClauses* with argument *call*.
3. If *has* is **true**, return **true**.
4. Let *has* be *HasCallInTailPosition* of *DefaultClause* with argument *call*.
5. If *has* is **true**, return **true**.
6. If the second *CaseClauses* is present, let *has* be *HasCallInTailPosition* of the second *CaseClauses* with argument *call*.
7. Return *has*.

*CaseClauses* : *CaseClauses* *CaseClause*

1. Let *has* be *HasCallInTailPosition* of *CaseClauses* with argument *call*.
2. If *has* is **true**, return **true**.
3. Return *HasCallInTailPosition* of *CaseClause* with argument *call*.

*CaseClause* : **case** *Expression* : *StatementList*<sub>opt</sub>

*DefaultClause* : **default** : *StatementList*<sub>opt</sub>

1. If *StatementList* is present, return *HasCallInTailPosition* of *StatementList* with argument *call*.
2. Return **false**.

*TryStatement* : **try** *Block* *Catch*

1. Return *HasCallInTailPosition* of *Catch* with argument *call*.

*TryStatement* :

**try** *Block* *Finally*

**try** *Block* *Catch* *Finally*

1. Return *HasCallInTailPosition* of *Finally* with argument *call*.

*Catch* : **catch** ( *CatchParameter* ) *Block*

1. Return *HasCallInTailPosition* of *Block* with argument *call*.

*AssignmentExpression* :

*YieldExpression*

*ArrowFunction*

*AsyncArrowFunction*

*LeftHandSideExpression* = *AssignmentExpression*

*LeftHandSideExpression* *AssignmentOperator* *AssignmentExpression*

*LeftHandSideExpression* **&&=** *AssignmentExpression*

*LeftHandSideExpression* **|=** *AssignmentExpression*

*LeftHandSideExpression* **??=** *AssignmentExpression*

*BitwiseANDExpression* :

*BitwiseANDExpression* **&** *EqualityExpression*

*BitwiseXORExpression* :

*BitwiseXORExpression* **^** *BitwiseANDExpression*

*BitwiseORExpression* :

*BitwiseORExpression* **|** *BitwiseXORExpression*

*EqualityExpression* :

*EqualityExpression* **==** *RelationalExpression*

*EqualityExpression* **!=** *RelationalExpression*

*EqualityExpression* **===** *RelationalExpression*

*EqualityExpression* **!==** *RelationalExpression*

*RelationalExpression* :

*RelationalExpression* **<** *ShiftExpression*

*RelationalExpression* **>** *ShiftExpression*

*RelationalExpression* **<=** *ShiftExpression*  
*RelationalExpression* **>=** *ShiftExpression*  
*RelationalExpression* **instanceof** *ShiftExpression*  
*RelationalExpression* **in** *ShiftExpression*  
*PrivateIdentifier* **in** *ShiftExpression*

*ShiftExpression* :  
*ShiftExpression* **<<** *AdditiveExpression*  
*ShiftExpression* **>>** *AdditiveExpression*  
*ShiftExpression* **>>>** *AdditiveExpression*

*AdditiveExpression* :  
*AdditiveExpression* **+** *MultiplicativeExpression*  
*AdditiveExpression* **-** *MultiplicativeExpression*

*MultiplicativeExpression* :  
*MultiplicativeExpression* *MultiplicativeOperator* *ExponentiationExpression*

*ExponentiationExpression* :  
*UpdateExpression* **\*\*** *ExponentiationExpression*

*UpdateExpression* :  
*LeftHandSideExpression* **++**  
*LeftHandSideExpression* **--**  
**++** *UnaryExpression*  
**--** *UnaryExpression*

*UnaryExpression* :  
**delete** *UnaryExpression*  
**void** *UnaryExpression*  
**typeof** *UnaryExpression*  
**+** *UnaryExpression*  
**-** *UnaryExpression*  
**-** *UnaryExpression*  
**!** *UnaryExpression*  
*AwaitExpression*

*CallExpression* :  
*SuperCall*  
*CallExpression* [ *Expression* ]  
*CallExpression* . *IdentifierName*  
*CallExpression* . *PrivateIdentifier*

*NewExpression* :  
**new** *NewExpression*

*MemberExpression* :  
*MemberExpression* [ *Expression* ]  
*MemberExpression* . *IdentifierName*  
*SuperProperty*  
*MetaProperty*  
**new** *MemberExpression* *Arguments*  
*MemberExpression* . *PrivateIdentifier*

*PrimaryExpression* :  
**this**  
*IdentifierReference*  
*Literal*  
*ArrayLiteral*  
*ObjectLiteral*  
*FunctionExpression*  
*ClassExpression*  
*GeneratorExpression*  
*AsyncFunctionExpression*  
*AsyncGeneratorExpression*  
*RegularExpressionLiteral*  
*TemplateLiteral*

1. Return **false**.

*Expression :*

*AssignmentExpression  
Expression , AssignmentExpression*

1. Return [HasCallInTailPosition](#) of *AssignmentExpression* with argument *call*.

*ConditionalExpression : ShortCircuitExpression ? AssignmentExpression : AssignmentExpression*

1. Let *has* be [HasCallInTailPosition](#) of the first *AssignmentExpression* with argument *call*.
2. If *has* is **true**, return **true**.
3. Return [HasCallInTailPosition](#) of the second *AssignmentExpression* with argument *call*.

*LogicalANDExpression : LogicalANDExpression && BitwiseORExpression*

1. Return [HasCallInTailPosition](#) of *BitwiseORExpression* with argument *call*.

*LogicalORExpression : LogicalORExpression || LogicalANDExpression*

1. Return [HasCallInTailPosition](#) of *LogicalANDExpression* with argument *call*.

*CoalesceExpression : CoalesceExpressionHead ?? BitwiseORExpression*

1. Return [HasCallInTailPosition](#) of *BitwiseORExpression* with argument *call*.

*CallExpression :*

*CoverCallExpressionAndAsyncArrowHead  
CallExpression Arguments  
CallExpression TemplateLiteral*

1. If this *CallExpression* is *call*, return **true**.
2. Return **false**.

*OptionalExpression :*

*MemberExpression OptionalChain  
CallExpression OptionalChain  
OptionalExpression OptionalChain*

1. Return [HasCallInTailPosition](#) of *OptionalChain* with argument *call*.

*OptionalChain :*

*? . [ Expression ]  
? . IdentifierName  
? . PrivateIdentifier  
OptionalChain [ Expression ]  
OptionalChain . IdentifierName  
OptionalChain . PrivateIdentifier*

1. Return **false**.

*OptionalChain :*

*? . Arguments  
OptionalChain Arguments*

1. If this *OptionalChain* is *call*, return **true**.
2. Return **false**.

*MemberExpression :*

*MemberExpression TemplateLiteral*

1. If this *MemberExpression* is *call*, return **true**.
2. Return **false**.

*PrimaryExpression : CoverParenthesizedExpressionAndArrowParameterList*

1. Let *expr* be the *ParenthesizedExpression* that is *covered* by *CoverParenthesizedExpressionAndArrowParameterList*.
2. Return *HasCallInTailPosition* of *expr* with argument *call*.

*ParenthesizedExpression :*  
( *Expression* )

1. Return *HasCallInTailPosition* of *Expression* with argument *call*.

### 15.10.3 PrepareForTailCall ( )

The abstract operation *PrepareForTailCall* takes no arguments and returns *unused*. It performs the following steps when called:

1. **Assert**: The current *execution context* will not subsequently be used for the evaluation of any ECMAScript code or built-in functions. The invocation of *Call* subsequent to the invocation of this abstract operation will create and push a new *execution context* before performing any such evaluation.
2. Discard all resources associated with the current *execution context*.
3. Return *unused*.

A tail position call must either release any transient internal resources associated with the currently executing function *execution context* before invoking the target function or reuse those resources in support of the target function.

**NOTE** For example, a tail position call should only grow an implementation's activation record stack by the amount that the size of the target function's activation record exceeds the size of the calling function's activation record. If the target function's activation record is smaller, then the total size of the stack should decrease.

## 16 ECMAScript Language: Scripts and Modules

### 16.1 Scripts

#### Syntax

*Script* :  
*ScriptBody*<sub>opt</sub>

*ScriptBody* :  
*StatementList*<sub>[~Yield, ~Await, ~Return]</sub>

#### 16.1.1 Static Semantics: Early Errors

*Script* : *ScriptBody*

- It is a Syntax Error if the [LexicallyDeclaredNames](#) of *ScriptBody* contains any duplicate entries.
- It is a Syntax Error if any element of the [LexicallyDeclaredNames](#) of *ScriptBody* also occurs in the [VarDeclaredNames](#) of *ScriptBody*.

*ScriptBody* : *StatementList*

- It is a Syntax Error if *StatementList* [Contains super](#) unless the source text containing **super** is eval code that is being processed by a [direct eval](#). Additional [early error](#) rules for **super** within [direct eval](#) are defined in [19.2.1.1](#).
- It is a Syntax Error if *StatementList* [Contains NewTarget](#) unless the source text containing *NewTarget* is eval code that is being processed by a [direct eval](#). Additional [early error](#) rules for *NewTarget* in [direct eval](#) are defined in [19.2.1.1](#).
- It is a Syntax Error if [ContainsDuplicateLabels](#) of *StatementList* with argument « » is **true**.
- It is a Syntax Error if [ContainsUndefinedBreakTarget](#) of *StatementList* with argument « » is **true**.
- It is a Syntax Error if [ContainsUndefinedContinueTarget](#) of *StatementList* with arguments « » and « » is **true**.
- It is a Syntax Error if [AllPrivateIdentifiersValid](#) of *StatementList* with argument « » is **false** unless the source text containing *ScriptBody* is eval code that is being processed by a [direct eval](#).

### 16.1.2 Static Semantics: IsStrict

The [syntax-directed operation](#) `IsStrict` takes no arguments and returns a Boolean. It is defined piecewise over the following productions:

*Script* : *ScriptBody*<sub>opt</sub>

1. If *ScriptBody* is present and the [Directive Prologue](#) of *ScriptBody* contains a [Use Strict Directive](#), return **true**; otherwise, return **false**.

### 16.1.3 Runtime Semantics: Evaluation

*Script* : [empty]

1. Return **undefined**.

### 16.1.4 Script Records

A *Script Record* encapsulates information about a script being evaluated. Each script record contains the fields listed in [Table 39](#).

Table 39: [Script Record Fields](#)

Field Name	Value Type	Meaning
[[Realm]]	a <a href="#">Realm Record</a> or <b>undefined</b>	The <a href="#">realm</a> within which this script was created. <b>undefined</b> if not yet assigned.
[[ECMAScriptCode]]	a <a href="#">Script Parse Node</a>	The result of parsing the source text of this script.
[[LoadedModules]]	a <a href="#">List of Records</a> with fields <a href="#">[[Specifier]]</a> (a String) and <a href="#">[[Module]]</a> (a <a href="#">Module Record</a> )	A map from the specifier strings imported by this script to the resolved <a href="#">Module Record</a> . The list does not contain two different <a href="#">Records</a> with the same <a href="#">[[Specifier]]</a> .
[[HostDefined]]	anything (default value is empty)	Field reserved for use by <a href="#">host environments</a> that need to associate additional information with a script.

### 16.1.5 ParseScript ( *sourceText*, *realm*, *hostDefined* )

The abstract operation ParseScript takes arguments *sourceText* (ECMAScript source text), *realm* (a *Realm Record* or **undefined**), and *hostDefined* (anything) and returns a *Script Record* or a non-empty *List* of **SyntaxError** objects. It creates a *Script Record* based upon the result of parsing *sourceText* as a *Script*. It performs the following steps when called:

1. Let *script* be *ParseText*(*sourceText*, *Script*).
2. If *script* is a *List* of errors, return *script*.
3. Return *Script Record* { *[[Realm]]*: *realm*, *[[ECMAScriptCode]]*: *script*, *[[LoadedModules]]*: « », *[[HostDefined]]*: *hostDefined* }.

**NOTE** An implementation may parse script source text and analyse it for Early Error conditions prior to evaluation of ParseScript for that script source text. However, the reporting of any errors must be deferred until the point where this specification actually performs ParseScript upon that source text.

### 16.1.6 ScriptEvaluation ( *scriptRecord* )

The abstract operation ScriptEvaluation takes argument *scriptRecord* (a *Script Record*) and returns either a *normal completion containing* an ECMAScript language value or an *abrupt completion*. It performs the following steps when called:

1. Let *globalEnv* be *scriptRecord*.*[[Realm]]*.*[[GlobalEnv]]*.
2. Let *scriptContext* be a new ECMAScript code execution context.
3. Set the Function of *scriptContext* to **null**.
4. Set the *Realm* of *scriptContext* to *scriptRecord*.*[[Realm]]*.
5. Set the *ScriptOrModule* of *scriptContext* to *scriptRecord*.
6. Set the *VariableEnvironment* of *scriptContext* to *globalEnv*.
7. Set the *LexicalEnvironment* of *scriptContext* to *globalEnv*.
8. Set the *PrivateEnvironment* of *scriptContext* to **null**.
9. Suspend the *running execution context*.
10. Push *scriptContext* onto the *execution context stack*; *scriptContext* is now the *running execution context*.
11. Let *script* be *scriptRecord*.*[[ECMAScriptCode]]*.
12. Let *result* be *Completion*(*GlobalDeclarationInstantiation*(*script*, *globalEnv*)).
13. If *result*.*[[Type]]* is normal, then
  - a. Set *result* to *Completion*(*Evaluation* of *script*).
  - b. If *result*.*[[Type]]* is normal and *result*.*[[Value]]* is empty, then
    - i. Set *result* to *NormalCompletion*(**undefined**).
14. Suspend *scriptContext* and remove it from the *execution context stack*.
15. **Assert**: The *execution context stack* is not empty.
16. Resume the context that is now on the top of the *execution context stack* as the *running execution context*.
17. Return ? *result*.

### 16.1.7 GlobalDeclarationInstantiation ( *script*, *env* )

The abstract operation GlobalDeclarationInstantiation takes arguments *script* (a *Script Parse Node*) and *env* (a *Global Environment Record*) and returns either a *normal completion containing* unused or a *throw completion*. *script* is the *Script* for which the *execution context* is being established. *env* is the global environment in which bindings are to be created.

NOTE 1 When an [execution context](#) is established for evaluating scripts, declarations are instantiated in the current global environment. Each global binding declared in the code is instantiated.

It performs the following steps when called:

1. Let *lexNames* be the [LexicallyDeclaredNames](#) of *script*.
2. Let *varNames* be the [VarDeclaredNames](#) of *script*.
3. For each element *name* of *lexNames*, do
  - a. If *env*.[HasVarDeclaration](#)(*name*) is **true**, throw a **SyntaxError** exception.
  - b. If *env*.[HasLexicalDeclaration](#)(*name*) is **true**, throw a **SyntaxError** exception.
  - c. Let *hasRestrictedGlobal* be ? *env*.[HasRestrictedGlobalProperty](#)(*name*).
  - d. If *hasRestrictedGlobal* is **true**, throw a **SyntaxError** exception.
4. For each element *name* of *varNames*, do
  - a. If *env*.[HasLexicalDeclaration](#)(*name*) is **true**, throw a **SyntaxError** exception.
5. Let *varDeclarations* be the [VarScopedDeclarations](#) of *script*.
6. Let *functionsToInitialize* be a new empty [List](#).
7. Let *declaredFunctionNames* be a new empty [List](#).
8. For each element *d* of *varDeclarations*, in reverse [List](#) order, do
  - a. If *d* is not either a [VariableDeclaration](#), a [ForBinding](#), or a [BindingIdentifier](#), then
    - i. **Assert**: *d* is either a [FunctionDeclaration](#), a [GeneratorDeclaration](#), an [AsyncFunctionDeclaration](#), or an [AsyncGeneratorDeclaration](#).
    - ii. NOTE: If there are multiple function declarations for the same name, the last declaration is used.
    - iii. Let *fn* be the sole element of the [BoundNames](#) of *d*.
    - iv. If *declaredFunctionNames* does not contain *fn*, then
      1. Let *fnDefinable* be ? *env*.[CanDeclareGlobalFunction](#)(*fn*).
      2. If *fnDefinable* is **false**, throw a **TypeError** exception.
      3. Append *fn* to *declaredFunctionNames*.
      4. Insert *d* as the first element of *functionsToInitialize*.
9. Let *declaredVarNames* be a new empty [List](#).
10. For each element *d* of *varDeclarations*, do
  - a. If *d* is either a [VariableDeclaration](#), a [ForBinding](#), or a [BindingIdentifier](#), then
    - i. For each String *vn* of the [BoundNames](#) of *d*, do
      1. If *declaredFunctionNames* does not contain *vn*, then
        - a. Let *vnDefinable* be ? *env*.[CanDeclareGlobalVar](#)(*vn*).
        - b. If *vnDefinable* is **false**, throw a **TypeError** exception.
        - c. If *declaredVarNames* does not contain *vn*, then
          - i. Append *vn* to *declaredVarNames*.
11. NOTE: No abnormal terminations occur after this algorithm step if the [global object](#) is an [ordinary object](#). However, if the [global object](#) is a [Proxy exotic object](#) it may exhibit behaviours that cause abnormal terminations in some of the following steps.
12. NOTE: Annex [B.3.2.2](#) adds additional steps at this point.
13. Let *lexDeclarations* be the [LexicallyScopedDeclarations](#) of *script*.
14. Let *privateEnv* be **null**.
15. For each element *d* of *lexDeclarations*, do
  - a. NOTE: Lexically declared names are only instantiated here but not initialized.
  - b. For each element *dn* of the [BoundNames](#) of *d*, do
    - i. If [IsConstantDeclaration](#) of *d* is **true**, then
      1. Perform ? *env*.[CreateImmutableBinding](#)(*dn*, **true**).
    - ii. Else,
      1. Perform ? *env*.[CreateMutableBinding](#)(*dn*, **false**).

16. For each [Parse Node \*f\*](#) of [functionsToInitialize](#), do
  - a. Let *fn* be the sole element of the [BoundNames](#) of *f*.
  - b. Let *fo* be [InstantiateFunctionObject](#) of *f* with arguments *env* and *privateEnv*.
  - c. Perform ? *env*.CreateGlobalFunctionBinding(*fn*, *fo*, **false**).
17. For each String *vn* of [declaredVarNames](#), do
  - a. Perform ? *env*.CreateGlobalVarBinding(*vn*, **false**).
18. Return unused.

**NOTE 2** [Early errors](#) specified in [16.1.1](#) prevent name conflicts between function/var declarations and let/const/class declarations as well as redeclaration of let/const/class bindings for declaration contained within a single *Script*. However, such conflicts and redeclarations that span more than one *Script* are detected as runtime errors during GlobalDeclarationInstantiation. If any such errors are detected, no bindings are instantiated for the script. However, if the [global object](#) is defined using [Proxy exotic objects](#) then the runtime tests for conflicting declarations may be unreliable resulting in an [abrupt completion](#) and some global declarations not being instantiated. If this occurs, the code for the *Script* is not evaluated.

Unlike explicit var or function declarations, properties that are directly created on the [global object](#) result in global bindings that may be shadowed by let/const/class declarations.

## 16.2 Modules

### Syntax

```

Module :
    ModuleBodyopt

ModuleBody :
    ModuleItemList

ModuleItemList :
    ModuleItem
    ModuleItemList ModuleItem

ModuleItem :
    ImportDeclaration
    ExportDeclaration
    StatementListItem[~Yield, +Await, ~Return]

ModuleExportName :
    IdentifierName
    StringLiteral
  
```

### 16.2.1 Module Semantics

#### 16.2.1.1 Static Semantics: Early Errors

*ModuleBody* : *ModuleItemList*

- It is a Syntax Error if the [LexicallyDeclaredNames](#) of *ModuleItemList* contains any duplicate entries.
- It is a Syntax Error if any element of the [LexicallyDeclaredNames](#) of *ModuleItemList* also occurs in the [VarDeclaredNames](#) of *ModuleItemList*.
- It is a Syntax Error if the [ExportedNames](#) of *ModuleItemList* contains any duplicate entries.
- It is a Syntax Error if any element of the [ExportedBindings](#) of *ModuleItemList* does not also occur in either the [VarDeclaredNames](#) of *ModuleItemList*, or the [LexicallyDeclaredNames](#) of *ModuleItemList*.



- It is a Syntax Error if *ModuleItemList* **Contains super**.
- It is a Syntax Error if *ModuleItemList* **Contains NewTarget**.
- It is a Syntax Error if **ContainsDuplicateLabels** of *ModuleItemList* with argument « » is **true**.
- It is a Syntax Error if **ContainsUndefinedBreakTarget** of *ModuleItemList* with argument « » is **true**.
- It is a Syntax Error if **ContainsUndefinedContinueTarget** of *ModuleItemList* with arguments « » and « » is **true**.
- It is a Syntax Error if **AllPrivateIdentifiersValid** of *ModuleItemList* with argument « » is **false**.

**NOTE** The duplicate **ExportedNames** rule implies that multiple **export default** *ExportDeclaration* items within a *ModuleBody* is a Syntax Error. Additional error conditions relating to conflicting or duplicate declarations are checked during module linking prior to evaluation of a *Module*. If any such errors are detected the *Module* is not evaluated.

*ModuleExportName* : *StringLiteral*

- It is a Syntax Error if **IsStringWellFormedUnicode**(the *SV* of *StringLiteral*) is **false**.

### 16.2.1.2 Static Semantics: ImportedLocalNames ( *importEntries* )

The abstract operation **ImportedLocalNames** takes argument *importEntries* (a *List* of *ImportEntry Records*) and returns a *List* of Strings. It creates a *List* of all of the local name bindings defined by *importEntries*. It performs the following steps when called:

1. Let *localNames* be a new empty *List*.
2. For each *ImportEntry Record* *i* of *importEntries*, do
  - a. Append *i*.[*LocalName*] to *localNames*.
3. Return *localNames*.

### 16.2.1.3 Static Semantics: ModuleRequests

The **syntax-directed operation** **ModuleRequests** takes no arguments and returns a *List* of Strings. It is defined piecewise over the following productions:

*Module* : [empty]

1. Return a new empty *List*.

*ModuleItemList* : *ModuleItem*

1. Return **ModuleRequests** of *ModuleItem*.

*ModuleItemList* : *ModuleItemList* *ModuleItem*

1. Let *moduleName* be **ModuleRequests** of *ModuleItem*.
2. Let *additionalNames* be **ModuleRequests** of *ModuleItem*.
3. For each String *name* of *additionalNames*, do
  - a. If *moduleName* does not contain *name*, then
    - i. Append *name* to *moduleName*.
4. Return *moduleName*.

*ModuleItem* : *StatementListItem*

1. Return a new empty *List*.

*ImportDeclaration* : **import** *ImportClause* *FromClause* ;

1. Return **ModuleRequests** of *FromClause*.

*ModuleSpecifier* : *StringLiteral*

1. Return a [List](#) whose sole element is the *SV* of *StringLiteral*.

*ExportDeclaration* : **export** *ExportFromClause FromClause* ;

1. Return the [ModuleRequests](#) of *FromClause*.

*ExportDeclaration* :

**export** *NamedExports* ;  
**export** *VariableStatement*  
**export** *Declaration*  
**export default** *HoistableDeclaration*  
**export default** *ClassDeclaration*  
**export default** *AssignmentExpression* ;

1. Return a new empty [List](#).

#### 16.2.1.4 Abstract Module Records

A *Module Record* encapsulates structural information about the imports and exports of a single module. This information is used to link the imports and exports of sets of connected modules. A *Module Record* includes four fields that are only used when evaluating a module.

For specification purposes *Module Record* values are values of the [Record](#) specification type and can be thought of as existing in a simple object-oriented hierarchy where *Module Record* is an abstract class with both abstract and concrete subclasses. This specification defines the abstract subclass named [Cyclic Module Record](#) and its concrete subclass named [Source Text Module Record](#). Other specifications and implementations may define additional *Module Record* subclasses corresponding to alternative module definition facilities that they defined.

*Module Record* defines the fields listed in [Table 40](#). All *Module Definition* subclasses include at least those fields. *Module Record* also defines the abstract method list in [Table 41](#). All *Module definition* subclasses must provide concrete implementations of these abstract methods.

**Table 40: Module Record Fields**

Field Name	Value Type	Meaning
[[Realm]]	a <a href="#">Realm Record</a>	The <a href="#">Realm</a> within which this module was created.
[[Environment]]	a <a href="#">Module Environment Record</a> or empty	The <a href="#">Environment Record</a> containing the top level bindings for this module. This field is set when the module is linked.
[[Namespace]]	an Object or empty	The <i>Module Namespace Object</i> ( <a href="#">28.3</a> ) if one has been created for this module.
[[HostDefined]]	anything (default value is <b>undefined</b> )	Field reserved for use by <a href="#">host environments</a> that need to associate additional information with a module.

Table 41: Abstract Methods of **Module Records**

Method	Purpose
LoadRequestedModules( [ <i>hostDefined</i> ] )	Prepares the module for linking by recursively loading all its dependencies, and returns a promise.
GetExportedNames([ <i>exportStarSet</i> ])	Return a list of all names that are either directly or indirectly exported from this module.  LoadRequestedModules must have completed successfully prior to invoking this method.
ResolveExport( <i>exportName</i> [, <i>resolveSet</i> ])	Return the binding of a name exported by this module. Bindings are represented by a <i>ResolvedBinding Record</i> , of the form { [[Module]]: <b>Module Record</b> , [[BindingName]]: String   namespace }. If the export is a Module Namespace Object without a direct binding in any module, [[BindingName]] will be set to namespace. Return <b>null</b> if the name cannot be resolved, or ambiguous if multiple bindings were found.  Each time this operation is called with a specific <i>exportName</i> , <i>resolveSet</i> pair as arguments it must return the same result.  LoadRequestedModules must have completed successfully prior to invoking this method.
Link()	Prepare the module for evaluation by transitively resolving all module dependencies and creating a <b>Module Environment Record</b> .  LoadRequestedModules must have completed successfully prior to invoking this method.
Evaluate()	Returns a promise for the evaluation of this module and its dependencies, resolving on successful evaluation or if it has already been evaluated successfully, and rejecting for an evaluation error or if it has already been evaluated unsuccessfully. If the promise is rejected, <i>hosts</i> are expected to handle the promise rejection and rethrow the evaluation error.  Link must have completed successfully prior to invoking this method.

### 16.2.1.5 Cyclic Module Records

A *Cyclic Module Record* is used to represent information about a module that can participate in dependency cycles with other modules that are subclasses of the **Cyclic Module Record** type. **Module Records** that are not subclasses of the **Cyclic Module Record** type must not participate in dependency cycles with **Source Text Module Records**.

In addition to the fields defined in **Table 40 Cyclic Module Records** have the additional fields listed in **Table 42**

Table 42: Additional Fields of **Cyclic Module Records**

Field Name	Value Type	Meaning
[[Status]]	new, unlinked, linking, linked, evaluating, evaluating-async, or evaluated	Initially new. Transitions to unlinked, linking, linked, evaluating, possibly evaluating-async, evaluated (in that order) as the module progresses throughout its lifecycle. evaluating-async indicates this module is queued to execute on completion of its asynchronous dependencies or it is a module whose [[HasTLA]] field is <b>true</b> that has been executed and is pending top-level completion.
[[EvaluationError]]	a <b>throw completion</b> or empty	A <b>throw completion</b> representing the exception that occurred during evaluation. <b>undefined</b> if no exception occurred or if [[Status]] is not evaluated.
[[DFSIndex]]	an <b>integer</b> or empty	Auxiliary field used during Link and Evaluate only. If [[Status]] is either linking or evaluating, this non-negative number records the point at which the module was first visited during the depth-first traversal of the dependency graph.
[[DFSAncestorIndex]]	an <b>integer</b> or empty	Auxiliary field used during Link and Evaluate only. If [[Status]] is either linking or evaluating, this is either the module's own [[DFSIndex]] or that of an "earlier" module in the same strongly connected component.
[[RequestedModules]]	a <b>List</b> of Strings	A <b>List</b> of all the <i>ModuleSpecifier</i> strings used by the module represented by this record to request the importation of a module. The <b>List</b> is in source text occurrence order.
[[LoadedModules]]	a <b>List</b> of <b>Records</b> with fields [[Specifier]] (a String) and [[Module]] (a <b>Module Record</b> )	A map from the specifier strings used by the module represented by this record to request the importation of a module to the resolved <b>Module Record</b> . The list does not contain two different <b>Records</b> with the same [[Specifier]].
[[CycleRoot]]	a <b>Cyclic Module Record</b> or empty	The first visited module of the cycle, the root DFS ancestor of the strongly connected component. For a module not in a cycle, this would be the module itself. Once Evaluate has completed, a module's [[DFSAncestorIndex]] is the [[DFSIndex]] of its [[CycleRoot]].
[[HasTLA]]	a Boolean	Whether this module is individually asynchronous (for example, if it's a <b>Source Text Module Record</b> containing a top-level await). Having an asynchronous dependency does not mean this field is <b>true</b> . This field must not change after the module is parsed.
[[AsyncEvaluation]]	a Boolean	Whether this module is either itself asynchronous or has an asynchronous dependency. Note: The order in which this field is set is used to order queued executions, see <a href="#">16.2.1.5.3.4</a> .

Table 42 (continued)

Field Name	Value Type	Meaning
[[TopLevelCapability]]	a <a href="#">PromiseCapability Record</a> or empty	If this module is the <a href="#">[[CycleRoot]]</a> of some cycle, and <code>Evaluate()</code> was called on some module in that cycle, this field contains the <a href="#">PromiseCapability Record</a> for that entire evaluation. It is used to settle the Promise object that is returned from the <code>Evaluate()</code> abstract method. This field will be empty for any dependencies of that module, unless a top-level <code>Evaluate()</code> has been initiated for some of those dependencies.
[[AsyncParentModules]]	a <a href="#">List of Cyclic Module Records</a>	If this module or a dependency has <a href="#">[[HasTLA]]</a> <b>true</b> , and execution is in progress, this tracks the parent importers of this module for the top-level execution job. These parent modules will not start executing before this module has successfully completed execution.
[[PendingAsyncDependencies]]	an <a href="#">integer</a> or empty	If this module has any asynchronous dependencies, this tracks the number of asynchronous dependency modules remaining to execute for this module. A module with asynchronous dependencies will be executed when this field reaches 0 and there are no execution errors.

In addition to the methods defined in [Table 41 Cyclic Module Records](#) have the additional methods listed in [Table 43](#)

Table 43: Additional Abstract Methods of [Cyclic Module Records](#)

Method	Purpose
<code>InitializeEnvironment()</code>	Initialize the <a href="#">Environment Record</a> of the module, including resolving all imported bindings, and create the module's <a href="#">execution context</a> .
<code>ExecuteModule( [ <a href="#">promiseCapability</a> ] )</code>	Evaluate the module's code within its <a href="#">execution context</a> . If this module has <b>true</b> in <a href="#">[[HasTLA]]</a> , then a <a href="#">PromiseCapability Record</a> is passed as an argument, and the method is expected to resolve or reject the given capability. In this case, the method must not throw an exception, but instead reject the <a href="#">PromiseCapability Record</a> if necessary.

A [GraphLoadingState Record](#) is a [Record](#) that contains information about the loading process of a module graph. It's used to continue loading after a call to [HostLoadImportedModule](#). Each [GraphLoadingState Record](#) has the fields defined in [Table 44](#):

Table 44: **GraphLoadingState Record Fields**

Field Name	Value Type	Meaning
[[PromiseCapability]]	a <a href="#">PromiseCapability Record</a>	The promise to resolve when the loading process finishes.
[[IsLoading]]	a Boolean	It is true if the loading process has not finished yet, neither successfully nor with an error.
[[PendingModulesCount]]	a non-negative integer	It tracks the number of pending <a href="#">HostLoadImportedModule</a> calls.
[[Visited]]	a <a href="#">List of Cyclic Module Records</a>	It is a list of the <a href="#">Cyclic Module Records</a> that have been already loaded by the current loading process, to avoid infinite loops with circular dependencies.
[[HostDefined]]	anything (default value is empty)	It contains <a href="#">host-defined</a> data to pass from the <a href="#">LoadRequestedModules</a> caller to <a href="#">HostLoadImportedModule</a> .

#### 16.2.1.5.1 LoadRequestedModules ( [ *hostDefined* ] )

The LoadRequestedModules concrete method of a [Cyclic Module Record](#) *module* takes optional argument *hostDefined* (anything) and returns a Promise. It populates the [[LoadedModules]] of all the [Module Records](#) in the dependency graph of *module* (most of the work is done by the auxiliary function [InnerModuleLoading](#)). It takes an optional *hostDefined* parameter that is passed to the [HostLoadImportedModule](#) hook. It performs the following steps when called:

1. If *hostDefined* is not present, let *hostDefined* be empty.
2. Let *pc* be ! [NewPromiseCapability\(%Promise%\)](#).
3. Let *state* be the [GraphLoadingState Record](#) { [[IsLoading]]: **true**, [[PendingModulesCount]]: 1, [[Visited]]: « », [[PromiseCapability]]: *pc*, [[HostDefined]]: *hostDefined* }.
4. Perform [InnerModuleLoading\(state, module\)](#).
5. Return *pc*.[[Promise]].

**NOTE** The *hostDefined* parameter can be used to pass additional information necessary to fetch the imported modules. It is used, for example, by HTML to set the correct fetch destination for `<link rel="preload" as="...">` tags. `import()` expressions never set the *hostDefined* parameter.

##### 16.2.1.5.1.1 InnerModuleLoading ( *state*, *module* )

The abstract operation InnerModuleLoading takes arguments *state* (a [GraphLoadingState Record](#)) and *module* (a [Module Record](#)) and returns unused. It is used by LoadRequestedModules to recursively perform the actual loading process for *module*'s dependency graph. It performs the following steps when called:

1. **Assert:** *state*.[[IsLoading]] is **true**.
2. If *module* is a [Cyclic Module Record](#), *module*.[[Status]] is new, and *state*.[[Visited]] does not contain *module*, then
  - a. Append *module* to *state*.[[Visited]].
  - b. Let *requestedModulesCount* be the number of elements in *module*.[[RequestedModules]].
  - c. Set *state*.[[PendingModulesCount]] to *state*.[[PendingModulesCount]] + *requestedModulesCount*.
  - d. For each String *required* of *module*.[[RequestedModules]], do
    - i. If *module*.[[LoadedModules]] contains a [Record](#) whose [[Specifier]] is *required*, then

1. Let *record* be that **Record**.
2. Perform **InnerModuleLoading**(*state*, *record*.[[Module]]).
- ii. Else,
  1. Perform **HostLoadImportedModule**(*module*, *required*, *state*.[[HostDefined]], *state*).
  2. NOTE: **HostLoadImportedModule** will call **FinishLoadingImportedModule**, which re-enters the graph loading process through **ContinueModuleLoading**.
- iii. If *state*.[[IsLoading]] is **false**, return unused.
3. **Assert**: *state*.[[PendingModulesCount]] ≥ 1.
4. Set *state*.[[PendingModulesCount]] to *state*.[[PendingModulesCount]] - 1.
5. If *state*.[[PendingModulesCount]] = 0, then
  - a. Set *state*.[[IsLoading]] to **false**.
  - b. For each **Cyclic Module Record** *loaded* of *state*.[[Visited]], do
    - i. If *loaded*.[[Status]] is new, set *loaded*.[[Status]] to unlinked.
  - c. Perform ! **Call**(*state*.[[PromiseCapability]].[[Resolve]], **undefined**, « **undefined** »).
6. Return unused.

#### 16.2.1.5.1.2 ContinueModuleLoading ( *state*, *moduleCompletion* )

The abstract operation **ContinueModuleLoading** takes arguments *state* (a **GraphLoadingState Record**) and *moduleCompletion* (either a **normal completion** containing a **Module Record** or a **throw completion**) and returns unused. It is used to re-enter the loading process after a call to **HostLoadImportedModule**. It performs the following steps when called:

1. If *state*.[[IsLoading]] is **false**, return unused.
2. If *moduleCompletion* is a **normal completion**, then
  - a. Perform **InnerModuleLoading**(*state*, *moduleCompletion*.[[Value]]).
3. Else,
  - a. Set *state*.[[IsLoading]] to **false**.
  - b. Perform ! **Call**(*state*.[[PromiseCapability]].[[Reject]], **undefined**, « *moduleCompletion*.[[Value]] »).
4. Return unused.

#### 16.2.1.5.2 Link ( )

The **Link** concrete method of a **Cyclic Module Record** *module* takes no arguments and returns either a **normal completion** containing unused or a **throw completion**. On success, **Link** transitions this module's [[Status]] from unlinked to linked. On failure, an exception is thrown and this module's [[Status]] remains unlinked. (Most of the work is done by the auxiliary function **InnerModuleLinking**.) It performs the following steps when called:

1. **Assert**: *module*.[[Status]] is one of unlinked, linked, evaluating-async, or evaluated.
2. Let *stack* be a new empty **List**.
3. Let *result* be **Completion**(**InnerModuleLinking**(*module*, *stack*, 0)).
4. If *result* is an **abrupt completion**, then
  - a. For each **Cyclic Module Record** *m* of *stack*, do
    - i. **Assert**: *m*.[[Status]] is linking.
    - ii. Set *m*.[[Status]] to unlinked.
  - b. **Assert**: *module*.[[Status]] is unlinked.
  - c. Return ? *result*.
5. **Assert**: *module*.[[Status]] is one of linked, evaluating-async, or evaluated.
6. **Assert**: *stack* is empty.
7. Return unused.

#### 16.2.1.5.2.1 InnerModuleLinking ( *module*, *stack*, *index* )

The abstract operation InnerModuleLinking takes arguments *module* (a [Module Record](#)), *stack* (a [List of Cyclic Module Records](#)), and *index* (a non-negative [integer](#)) and returns either a [normal completion containing](#) a non-negative [integer](#) or a [throw completion](#). It is used by Link to perform the actual linking process for *module*, as well as recursively on all other modules in the dependency graph. The *stack* and *index* parameters, as well as a module's [\[\[DFSIndex\]\]](#) and [\[\[DFSAncestorIndex\]\]](#) fields, keep track of the depth-first search (DFS) traversal. In particular, [\[\[DFSAncestorIndex\]\]](#) is used to discover strongly connected components (SCCs), such that all modules in an SCC transition to linked together. It performs the following steps when called:

1. If *module* is not a [Cyclic Module Record](#), then
  - a. Perform ? *module*.Link().
  - b. Return *index*.
2. If *module*.[\[\[Status\]\]](#) is one of linking, linked, evaluating-async, or evaluated, then
  - a. Return *index*.
3. **Assert:** *module*.[\[\[Status\]\]](#) is unlinked.
4. Set *module*.[\[\[Status\]\]](#) to linking.
5. Set *module*.[\[\[DFSIndex\]\]](#) to *index*.
6. Set *module*.[\[\[DFSAncestorIndex\]\]](#) to *index*.
7. Set *index* to *index* + 1.
8. Append *module* to *stack*.
9. For each String *required* of *module*.[\[\[RequestedModules\]\]](#), do
  - a. Let *requiredModule* be [GetImportedModule](#)(*module*, *required*).
  - b. Set *index* to ? [InnerModuleLinking](#)(*requiredModule*, *stack*, *index*).
  - c. If *requiredModule* is a [Cyclic Module Record](#), then
    - i. **Assert:** *requiredModule*.[\[\[Status\]\]](#) is one of linking, linked, evaluating-async, or evaluated.
    - ii. **Assert:** *requiredModule*.[\[\[Status\]\]](#) is linking if and only if *stack* contains *requiredModule*.
    - iii. If *requiredModule*.[\[\[Status\]\]](#) is linking, then
      1. Set *module*.[\[\[DFSAncestorIndex\]\]](#) to [min](#)(*module*.[\[\[DFSAncestorIndex\]\]](#), *requiredModule*.[\[\[DFSAncestorIndex\]\]](#)).
10. Perform ? *module*.InitializeEnvironment().
11. **Assert:** *module* occurs exactly once in *stack*.
12. **Assert:** *module*.[\[\[DFSAncestorIndex\]\]](#) ≤ *module*.[\[\[DFSIndex\]\]](#).
13. If *module*.[\[\[DFSAncestorIndex\]\]](#) = *module*.[\[\[DFSIndex\]\]](#), then
  - a. Let *done* be **false**.
  - b. Repeat, while *done* is **false**,
    - i. Let *requiredModule* be the last element of *stack*.
    - ii. Remove the last element of *stack*.
    - iii. **Assert:** *requiredModule* is a [Cyclic Module Record](#).
    - iv. Set *requiredModule*.[\[\[Status\]\]](#) to linked.
    - v. If *requiredModule* and *module* are the same [Module Record](#), set *done* to **true**.
14. Return *index*.

#### 16.2.1.5.3 Evaluate ( )

The Evaluate concrete method of a [Cyclic Module Record](#) *module* takes no arguments and returns a Promise. Evaluate transitions this module's [\[\[Status\]\]](#) from linked to either evaluating-async or evaluated. The first time it is called on a module in a given strongly connected component, Evaluate creates and returns a Promise which resolves when the module has finished evaluating. This Promise is stored in the [\[\[TopLevelCapability\]\]](#) field of the [\[\[CycleRoot\]\]](#) for the component. Future invocations of Evaluate on any module in the component return the same Promise. (Most of the work is done by the auxiliary function [InnerModuleEvaluation](#).) It performs the following steps when called:



1. **Assert:** This call to Evaluate is not happening at the same time as another call to Evaluate within the surrounding agent.
2. **Assert:** *module*.[[Status]] is one of linked, evaluating-async, or evaluated.
3. If *module*.[[Status]] is either evaluating-async or evaluated, set *module* to *module*.[[CycleRoot]].
4. If *module*.[[TopLevelCapability]] is not empty, then
  - a. Return *module*.[[TopLevelCapability]].[[Promise]].
5. Let *stack* be a new empty List.
6. Let *capability* be ! **NewPromiseCapability**(%Promise%).
7. Set *module*.[[TopLevelCapability]] to *capability*.
8. Let *result* be **Completion**(**InnerModuleEvaluation**(*module*, *stack*, 0)).
9. If *result* is an abrupt completion, then
  - a. For each **Cyclic Module Record** *m* of *stack*, do
    - i. **Assert:** *m*.[[Status]] is evaluating.
    - ii. Set *m*.[[Status]] to evaluated.
    - iii. Set *m*.[[EvaluationError]] to *result*.
  - b. **Assert:** *module*.[[Status]] is evaluated.
  - c. **Assert:** *module*.[[EvaluationError]] is *result*.
  - d. Perform ! **Call**(*capability*.[[Reject]], **undefined**, « *result*.[[Value]] »).
10. Else,
  - a. **Assert:** *module*.[[Status]] is either evaluating-async or evaluated.
  - b. **Assert:** *module*.[[EvaluationError]] is empty.
  - c. If *module*.[[AsyncEvaluation]] is **false**, then
    - i. **Assert:** *module*.[[Status]] is evaluated.
    - ii. Perform ! **Call**(*capability*.[[Resolve]], **undefined**, « **undefined** »).
  - d. **Assert:** *stack* is empty.
11. Return *capability*.[[Promise]].

#### 16.2.1.5.3.1 InnerModuleEvaluation ( *module*, *stack*, *index* )

The abstract operation InnerModuleEvaluation takes arguments *module* (a **Module Record**), *stack* (a **List of Cyclic Module Records**), and *index* (a non-negative **integer**) and returns either a **normal completion containing** a non-negative **integer** or a **throw completion**. It is used by Evaluate to perform the actual evaluation process for *module*, as well as recursively on all other modules in the dependency graph. The *stack* and *index* parameters, as well as *module*'s [[DFSIndex]] and [[DFSAncestorIndex]] fields, are used the same way as in **InnerModuleLinking**. It performs the following steps when called:

1. If *module* is not a **Cyclic Module Record**, then
  - a. Let *promise* be ! *module*.Evaluate().
  - b. **Assert:** *promise*.[[PromiseState]] is not pending.
  - c. If *promise*.[[PromiseState]] is rejected, then
    - i. Return **ThrowCompletion**(*promise*.[[PromiseResult]]).
  - d. Return *index*.
2. If *module*.[[Status]] is either evaluating-async or evaluated, then
  - a. If *module*.[[EvaluationError]] is empty, return *index*.
  - b. Otherwise, return ? *module*.[[EvaluationError]].
3. If *module*.[[Status]] is evaluating, return *index*.
4. **Assert:** *module*.[[Status]] is linked.
5. Set *module*.[[Status]] to evaluating.
6. Set *module*.[[DFSIndex]] to *index*.
7. Set *module*.[[DFSAncestorIndex]] to *index*.
8. Set *module*.[[PendingAsyncDependencies]] to 0.
9. Set *index* to *index* + 1.

10. Append *module* to *stack*.
11. For each String *required* of *module*.[[RequestedModules]], do
  - a. Let *requiredModule* be *GetImportedModule*(*module*, *required*).
  - b. Set *index* to ? *InnerModuleEvaluation*(*requiredModule*, *stack*, *index*).
  - c. If *requiredModule* is a *Cyclic Module Record*, then
    - i. **Assert**: *requiredModule*.[[Status]] is one of evaluating, evaluating-async, or evaluated.
    - ii. **Assert**: *requiredModule*.[[Status]] is evaluating if and only if *stack* contains *requiredModule*.
    - iii. If *requiredModule*.[[Status]] is evaluating, then
      1. Set *module*.[[DFSAncestorIndex]] to  $\min(\text{module}.\text{[[DFSAncestorIndex]]}, \text{requiredModule}.\text{[[DFSAncestorIndex]])}$ .
    - iv. Else,
      1. Set *requiredModule* to *requiredModule*.[[CycleRoot]].
      2. **Assert**: *requiredModule*.[[Status]] is either evaluating-async or evaluated.
      3. If *requiredModule*.[[EvaluationError]] is not empty, return ? *requiredModule*.[[EvaluationError]].
    - v. If *requiredModule*.[[AsyncEvaluation]] is **true**, then
      1. Set *module*.[[PendingAsyncDependencies]] to *module*.[[PendingAsyncDependencies]] + 1.
      2. Append *module* to *requiredModule*.[[AsyncParentModules]].
12. If *module*.[[PendingAsyncDependencies]] > 0 or *module*.[[HasTLA]] is **true**, then
  - a. **Assert**: *module*.[[AsyncEvaluation]] is **false** and was never previously set to **true**.
  - b. Set *module*.[[AsyncEvaluation]] to **true**.
  - c. NOTE: The order in which module records have their [[AsyncEvaluation]] fields transition to **true** is significant. (See 16.2.1.5.3.4.)
  - d. If *module*.[[PendingAsyncDependencies]] = 0, perform *ExecuteAsyncModule*(*module*).
13. Otherwise, perform ? *module*.*ExecuteModule*().
14. **Assert**: *module* occurs exactly once in *stack*.
15. **Assert**: *module*.[[DFSAncestorIndex]] ≤ *module*.[[DFSIndex]].
16. If *module*.[[DFSAncestorIndex]] = *module*.[[DFSIndex]], then
  - a. Let *done* be **false**.
  - b. Repeat, while *done* is **false**,
    - i. Let *requiredModule* be the last element of *stack*.
    - ii. Remove the last element of *stack*.
    - iii. **Assert**: *requiredModule* is a *Cyclic Module Record*.
    - iv. If *requiredModule*.[[AsyncEvaluation]] is **false**, set *requiredModule*.[[Status]] to evaluated.
    - v. Otherwise, set *requiredModule*.[[Status]] to evaluating-async.
    - vi. If *requiredModule* and *module* are the same *Module Record*, set *done* to **true**.
    - vii. Set *requiredModule*.[[CycleRoot]] to *module*.
17. Return *index*.

NOTE 1 A module is evaluating while it is being traversed by *InnerModuleEvaluation*. A module is evaluated on execution completion or evaluating-async during execution if its [[HasTLA]] field is **true** or if it has asynchronous dependencies.

NOTE 2 Any modules depending on a module of an asynchronous cycle when that cycle is not evaluating will instead depend on the execution of the root of the cycle via [[CycleRoot]]. This ensures that the cycle state can be treated as a single strongly connected component through its root module state.

#### 16.2.1.5.3.2 ExecuteAsyncModule ( *module* )

The abstract operation ExecuteAsyncModule takes argument *module* (a [Cyclic Module Record](#)) and returns unused. It performs the following steps when called:

1. **Assert:** *module*.[[Status]] is either evaluating or evaluating-async.
2. **Assert:** *module*.[[HasTLA]] is **true**.
3. Let *capability* be ! [NewPromiseCapability](#)(%Promise%).
4. Let *fulfilledClosure* be a new [Abstract Closure](#) with no parameters that captures *module* and performs the following steps when called:
  - a. Perform [AsyncModuleExecutionFulfilled](#)(*module*).
  - b. Return **undefined**.
5. Let *onFulfilled* be [CreateBuiltinFunction](#)(*fulfilledClosure*, 0, "", « »).
6. Let *rejectedClosure* be a new [Abstract Closure](#) with parameters (*error*) that captures *module* and performs the following steps when called:
  - a. Perform [AsyncModuleExecutionRejected](#)(*module*, *error*).
  - b. Return **undefined**.
7. Let *onRejected* be [CreateBuiltinFunction](#)(*rejectedClosure*, 0, "", « »).
8. Perform [PerformPromiseThen](#)(*capability*.[[Promise]], *onFulfilled*, *onRejected*).
9. Perform ! *module*.ExecuteModule(*capability*).
10. Return unused.

#### 16.2.1.5.3.3 GatherAvailableAncestors ( *module*, *execList* )

The abstract operation GatherAvailableAncestors takes arguments *module* (a [Cyclic Module Record](#)) and *execList* (a [List of Cyclic Module Records](#)) and returns unused. It performs the following steps when called:

1. For each [Cyclic Module Record](#) *m* of *module*.[[AsyncParentModules]], do
  - a. If *execList* does not contain *m* and *m*.[[CycleRoot]].[[EvaluationError]] is empty, then
    - i. **Assert:** *m*.[[Status]] is evaluating-async.
    - ii. **Assert:** *m*.[[EvaluationError]] is empty.
    - iii. **Assert:** *m*.[[AsyncEvaluation]] is **true**.
    - iv. **Assert:** *m*.[[PendingAsyncDependencies]] > 0.
    - v. Set *m*.[[PendingAsyncDependencies]] to *m*.[[PendingAsyncDependencies]] - 1.
    - vi. If *m*.[[PendingAsyncDependencies]] = 0, then
      1. Append *m* to *execList*.
      2. If *m*.[[HasTLA]] is **false**, perform [GatherAvailableAncestors](#)(*m*, *execList*).
2. Return unused.

**NOTE** When an asynchronous execution for a root *module* is fulfilled, this function determines the list of modules which are able to synchronously execute together on this completion, populating them in *execList*.

#### 16.2.1.5.3.4 AsyncModuleExecutionFulfilled ( *module* )

The abstract operation AsyncModuleExecutionFulfilled takes argument *module* (a [Cyclic Module Record](#)) and returns unused. It performs the following steps when called:

1. If *module*.[[Status]] is evaluated, then
  - a. **Assert:** *module*.[[EvaluationError]] is not empty.
  - b. Return unused.

2. Assert: *module*.[[Status]] is evaluating-async.
3. Assert: *module*.[[AsyncEvaluation]] is **true**.
4. Assert: *module*.[[EvaluationError]] is empty.
5. Set *module*.[[AsyncEvaluation]] to **false**.
6. Set *module*.[[Status]] to evaluated.
7. If *module*.[[TopLevelCapability]] is not empty, then
  - a. Assert: *module*.[[CycleRoot]] is *module*.
  - b. Perform ! Call(*module*.[[TopLevelCapability]].[[Resolve]], **undefined**, « **undefined** »).
8. Let *execList* be a new empty List.
9. Perform GatherAvailableAncestors(*module*, *execList*).
10. Let *sortedExecList* be a List whose elements are the elements of *execList*, in the order in which they had their [[AsyncEvaluation]] fields set to **true** in InnerModuleEvaluation.
11. Assert: All elements of *sortedExecList* have their [[AsyncEvaluation]] field set to **true**, [[PendingAsyncDependencies]] field set to 0, and [[EvaluationError]] field set to empty.
12. For each Cyclic Module Record *m* of *sortedExecList*, do
  - a. If *m*.[[Status]] is evaluated, then
    - i. Assert: *m*.[[EvaluationError]] is not empty.
  - b. Else if *m*.[[HasTLA]] is **true**, then
    - i. Perform ExecuteAsyncModule(*m*).
  - c. Else,
    - i. Let *result* be *m*.ExecuteModule().
    - ii. If *result* is an abrupt completion, then
      1. Perform AsyncModuleExecutionRejected(*m*, *result*.[[Value]]).
    - iii. Else,
      1. Set *m*.[[Status]] to evaluated.
      2. If *m*.[[TopLevelCapability]] is not empty, then
        - a. Assert: *m*.[[CycleRoot]] is *m*.
        - b. Perform ! Call(*m*.[[TopLevelCapability]].[[Resolve]], **undefined**, « **undefined** »).
13. Return unused.

#### 16.2.1.5.3.5 AsyncModuleExecutionRejected ( *module*, *error* )

The abstract operation AsyncModuleExecutionRejected takes arguments *module* (a Cyclic Module Record) and *error* (an ECMAScript language value) and returns unused. It performs the following steps when called:

1. If *module*.[[Status]] is evaluated, then
  - a. Assert: *module*.[[EvaluationError]] is not empty.
  - b. Return unused.
2. Assert: *module*.[[Status]] is evaluating-async.
3. Assert: *module*.[[AsyncEvaluation]] is **true**.
4. Assert: *module*.[[EvaluationError]] is empty.
5. Set *module*.[[EvaluationError]] to ThrowCompletion(*error*).
6. Set *module*.[[Status]] to evaluated.
7. For each Cyclic Module Record *m* of *module*.[[AsyncParentModules]], do
  - a. Perform AsyncModuleExecutionRejected(*m*, *error*).
8. If *module*.[[TopLevelCapability]] is not empty, then
  - a. Assert: *module*.[[CycleRoot]] is *module*.
  - b. Perform ! Call(*module*.[[TopLevelCapability]].[[Reject]], **undefined**, « *error* »).
9. Return unused.

#### 16.2.1.5.4 Example Cyclic Module Record Graphs

This non-normative section gives a series of examples of the linking and evaluation of a few common module graphs, with a specific focus on how errors can occur.

First consider the following simple module graph:

Figure 2: A simple module graph

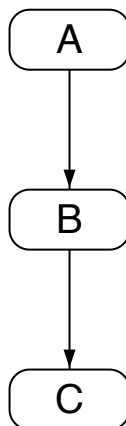

Let's first assume that there are no error conditions. When a `host` first calls `A.LoadRequestedModules()`, this will complete successfully by assumption, and recursively load the dependencies of `B` and `C` as well (respectively, `C` and none), and then set `A.[[Status]] = B.[[Status]] = C.[[Status]] = unlinked`. Then, when the `host` calls `A.Link()`, it will complete successfully (again by assumption) such that `A.[[Status]] = B.[[Status]] = C.[[Status]] = linked`. These preparatory steps can be performed at any time. Later, when the `host` is ready to incur any possible side effects of the modules, it can call `A.Evaluate()`, which will complete successfully, returning a Promise resolving to `undefined` (again by assumption), recursively having evaluated first `C` and then `B`. Each module's `[[Status]]` at this point will be evaluated.

Consider then cases involving linking errors, after a successful call to `A.LoadRequestedModules()`. If `InnerModuleLinking` of `C` succeeds but, thereafter, fails for `B`, for example because it imports something that `C` does not provide, then the original `A.Link()` will fail, and both `A` and `B`'s `[[Status]]` remain unlinked. `C`'s `[[Status]]` has become linked, though.

Finally, consider a case involving evaluation errors after a successful call to `Link()`. If `InnerModuleEvaluation` of `C` succeeds but, thereafter, fails for `B`, for example because `B` contains code that throws an exception, then the original `A.Evaluate()` will fail, returning a rejected Promise. The resulting exception will be recorded in both `A` and `B`'s `[[EvaluationError]]` fields, and their `[[Status]]` will become evaluated. `C` will also become evaluated but, in contrast to `A` and `B`, will remain without an `[[EvaluationError]]`, as it successfully completed evaluation. Storing the exception ensures that any time a `host` tries to reuse `A` or `B` by calling their `Evaluate()` method, it will encounter the same exception. (`Hosts` are not required to reuse `Cyclic Module Records`; similarly, `hosts` are not required to expose the exception objects thrown by these methods. However, the specification enables such uses.)

Now consider a different type of error condition:

Figure 3: A module graph with an unresolvable module

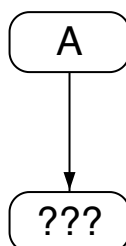

In this scenario, module *A* declares a dependency on some other module, but no *Module Record* exists for that module, i.e. *HostLoadImportedModule* calls *FinishLoadingImportedModule* with an exception when asked for it. This could occur for a variety of reasons, such as the corresponding resource not existing, or the resource existing but *ParseModule* returning some errors when trying to parse the resulting source text. *Hosts* can choose to expose the cause of failure via the completion they pass to *FinishLoadingImportedModule*. In any case, this exception causes a loading failure, which results in *A*'s `[[Status]]` remaining new.

The difference here between loading, linking and evaluation errors is due to the following characteristic:

- *Evaluation* must be only performed once, as it can cause side effects; it is thus important to remember whether evaluation has already been performed, even if unsuccessfully. (In the error case, it makes sense to also remember the exception because otherwise subsequent *Evaluate()* calls would have to synthesize a new one.)
- Linking, on the other hand, is side-effect-free, and thus even if it fails, it can be retried at a later time with no issues.
- Loading closely interacts with the *host*, and it may be desirable for some of them to allow users to retry failed loads (for example, if the failure is caused by temporarily bad network conditions).

Now, consider a module graph with a cycle:

Figure 4: A cyclic module graph

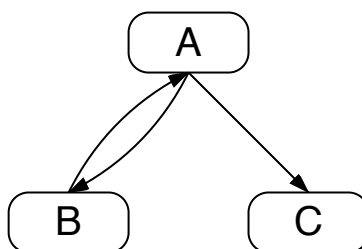

Here we assume that the entry point is module *A*, so that the *host* proceeds by calling *A.LoadRequestedModules()*, which performs *InnerModuleLoading* on *A*. This in turn calls *InnerModuleLoading* on *B* and *C*. Because of the cycle, this again triggers *InnerModuleLoading* on *A*, but at this point it is a no-op since *A*'s dependencies loading has already been triggered during this *LoadRequestedModules* process. When all the modules in the graph have been successfully loaded, their `[[Status]]` transitions from new to unlinked at the same time.

Then the *host* proceeds by calling *A.Link()*, which performs *InnerModuleLinking* on *A*. This in turn calls *InnerModuleLinking* on *B*. Because of the cycle, this again triggers *InnerModuleLinking* on *A*, but at this point it is a no-op since *A*.`[[Status]]` is already linking. *B*.`[[Status]]` itself remains linking when control gets back to *A* and *InnerModuleLinking* is triggered on *C*. After this returns with *C*.`[[Status]]` being linked, both *A* and *B* transition from linking to linked together; this is by design, since they form a strongly connected component. It's possible to transition the status of modules in the same SCC at the same time because during this phase the module graph is traversed with a depth-first search.

An analogous story occurs for the evaluation phase of a cyclic module graph, in the success case.

Now consider a case where *A* has a linking error; for example, it tries to import a binding from *C* that does not exist. In that case, the above steps still occur, including the early return from the second call to *InnerModuleLinking* on *A*. However, once we unwind back to the original *InnerModuleLinking* on *A*, it fails during *InitializeEnvironment*, namely right after *C.ResolveExport()*. The thrown **SyntaxError** exception propagates up to *A.Link*, which resets all modules that are currently on its *stack* (these are always exactly the modules that are still linking). Hence both *A* and *B* become unlinked. Note that *C* is left as linked.

Alternatively, consider a case where *A* has an evaluation error; for example, its source code throws an exception. In that case, the evaluation-time analog of the above steps still occurs, including the early return from the second call to *InnerModuleEvaluation* on *A*. However, once we unwind back to the original *InnerModuleEvaluation* on *A*, it fails by assumption. The exception thrown propagates up to *A.Evaluate()*,

which records the error in all modules that are currently on its *stack* (i.e., the modules that are still evaluating) as well as via `[[AsyncParentModules]]`, which form a chain for modules which contain or depend on top-level `await` through the whole dependency graph through the `AsyncModuleExecutionRejected` algorithm. Hence both *A* and *B* become evaluated and the exception is recorded in both *A* and *B*'s `[[EvaluationError]]` fields, while *C* is left as evaluated with no `[[EvaluationError]]`.

Lastly, consider a module graph with a cycle, where all modules complete asynchronously:

Figure 5: An asynchronous cyclic module graph

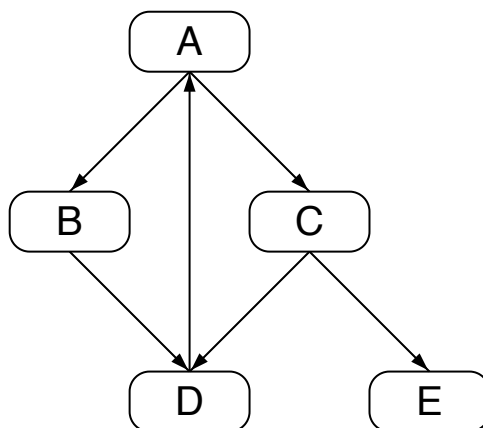

Loading and linking happen as before, and all modules end up with `[[Status]]` set to `linked`.

Calling `A.Evaluate()` calls `InnerModuleEvaluation` on *A*, *B*, and *D*, which all transition to evaluating. Then `InnerModuleEvaluation` is called on *A* again, which is a no-op because it is already evaluating. At this point, `D.{{PendingAsyncDependencies}}` is 0, so `ExecuteAsyncModule(D)` is called and we call `D.ExecuteModule` with a new `PromiseCapability` tracking the asynchronous execution of *D*. We unwind back to the `InnerModuleEvaluation` on *B*, setting `B.{{PendingAsyncDependencies}}` to 1 and `B.{{AsyncEvaluation}}` to `true`. We unwind back to the original `InnerModuleEvaluation` on *A*, setting `A.{{PendingAsyncDependencies}}` to 1. In the next iteration of the loop over *A*'s dependencies, we call `InnerModuleEvaluation` on *C* and thus on *D* (again a no-op) and *E*. As *E* has no dependencies and is not part of a cycle, we call `ExecuteAsyncModule(E)` in the same manner as *D* and *E* is immediately removed from the stack. We unwind once more to the original `InnerModuleEvaluation` on *A*, setting `C.{{AsyncEvaluation}}` to `true`. Now we finish the loop over *A*'s dependencies, set `A.{{AsyncEvaluation}}` to `true`, and remove the entire strongly connected component from the stack, transitioning all of the modules to `evaluating-async` at once. At this point, the fields of the modules are as given in Table 45.

Table 45: Module fields after the initial `Evaluate()` call

Fields	<i>A</i>	<i>B</i>	<i>C</i>	<i>D</i>	<i>E</i>
<code>[[DFSIndex]]</code>	0	1	2	3	4
<code>[[DFSAncestorIndex]]</code>	0	0	0	0	4
<code>[[Status]]</code>	evaluating-async	evaluating-async	evaluating-async	evaluating-async	evaluating-async
<code>[[AsyncEvaluation]]</code>	<code>true</code>	<code>true</code>	<code>true</code>	<code>true</code>	<code>true</code>
<code>[[AsyncParentModules]]</code>	« »	« <i>A</i> »	« <i>A</i> »	« <i>B</i> , <i>C</i> »	« <i>C</i> »
<code>[[PendingAsyncDependencies]]</code>	2 ( <i>B</i> and <i>C</i> )	1 ( <i>D</i> )	2 ( <i>D</i> and <i>E</i> )	0	0

Let us assume that *E* finishes executing first. When that happens, `AsyncModuleExecutionFulfilled` is called, `E.{{Status}}` is set to `evaluated` and `C.{{PendingAsyncDependencies}}` is decremented to become 1. The fields of the updated modules are as given in Table 46.

Table 46: Module fields after module *E* finishes executing

Fields	<i>C</i>	<i>E</i>
[[DFSIndex]]	2	4
[[DFSAncestorIndex]]	0	4
[[Status]]	evaluating-async	evaluated
[[AsyncEvaluation]]	<b>true</b>	<b>true</b>
[[AsyncParentModules]]	« <i>A</i> »	« <i>C</i> »
[[PendingAsyncDependencies]]	1 ( <i>D</i> )	0

*D* is next to finish (as it was the only module that was still executing). When that happens, `AsyncModuleExecutionFulfilled` is called again and *D*.[[Status]] is set to evaluated. Then *B*.[[PendingAsyncDependencies]] is decremented to become 0, `ExecuteAsyncModule` is called on *B*, and it starts executing. *C*.[[PendingAsyncDependencies]] is also decremented to become 0, and *C* starts executing (potentially in parallel to *B* if *B* contains an `await`). The fields of the updated modules are as given in Table 47.

Table 47: Module fields after module *D* finishes executing

Fields	<i>B</i>	<i>C</i>	<i>D</i>
[[DFSIndex]]	1	2	3
[[DFSAncestorIndex]]	0	0	0
[[Status]]	evaluating-async	evaluating-async	evaluated
[[AsyncEvaluation]]	<b>true</b>	<b>true</b>	<b>true</b>
[[AsyncParentModules]]	« <i>A</i> »	« <i>A</i> »	« <i>B</i> , <i>C</i> »
[[PendingAsyncDependencies]]	0	0	0

Let us assume that *C* finishes executing next. When that happens, `AsyncModuleExecutionFulfilled` is called again, *C*.[[Status]] is set to evaluated and *A*.[[PendingAsyncDependencies]] is decremented to become 1. The fields of the updated modules are as given in Table 48.

Table 48: Module fields after module *C* finishes executing

Fields	<i>A</i>	<i>C</i>
[[DFSIndex]]	0	2
[[DFSAncestorIndex]]	0	0
[[Status]]	evaluating-async	evaluated
[[AsyncEvaluation]]	<b>true</b>	<b>true</b>
[[AsyncParentModules]]	« »	« <i>A</i> »
[[PendingAsyncDependencies]]	1 ( <i>B</i> )	0

Then, *B* finishes executing. When that happens, `AsyncModuleExecutionFulfilled` is called again and *B*.[[Status]] is set to evaluated. *A*.[[PendingAsyncDependencies]] is decremented to become 0, so



`ExecuteAsyncModule` is called and it starts executing. The fields of the updated modules are as given in Table 49.

Table 49: Module fields after module *B* finishes executing

Fields	<i>A</i>	<i>B</i>
<code>[[DFSIndex]]</code>	0	1
<code>[[DFSAncestorIndex]]</code>	0	0
<code>[[Status]]</code>	evaluating-async	evaluated
<code>[[AsyncEvaluation]]</code>	<b>true</b>	<b>true</b>
<code>[[AsyncParentModules]]</code>	« »	« <i>A</i> »
<code>[[PendingAsyncDependencies]]</code>	0	0

Finally, *A* finishes executing. When that happens, `AsyncModuleExecutionFulfilled` is called again and *A*.`[[Status]]` is set to evaluated. At this point, the Promise in *A*.`[[TopLevelCapability]]` (which was returned from *A*.`Evaluate()`) is resolved, and this concludes the handling of this module graph. The fields of the updated module are as given in Table 50.

Table 50: Module fields after module *A* finishes executing

Fields	<i>A</i>
<code>[[DFSIndex]]</code>	0
<code>[[DFSAncestorIndex]]</code>	0
<code>[[Status]]</code>	evaluated
<code>[[AsyncEvaluation]]</code>	<b>true</b>
<code>[[AsyncParentModules]]</code>	« »
<code>[[PendingAsyncDependencies]]</code>	0

Alternatively, consider a failure case where *C* fails execution and returns an error before *B* has finished executing. When that happens, `AsyncModuleExecutionRejected` is called, which sets *C*.`[[Status]]` to evaluated and *C*.`[[EvaluationError]]` to the error. It then propagates this error to all of the `AsyncParentModules` by performing `AsyncModuleExecutionRejected` on each of them. The fields of the updated modules are as given in Table 51.

Table 51: Module fields after module *C* finishes with an error

Fields	<i>A</i>	<i>C</i>
<code>[[DFSIndex]]</code>	0	2
<code>[[DFSAncestorIndex]]</code>	0	1
<code>[[Status]]</code>	evaluated	evaluated
<code>[[AsyncEvaluation]]</code>	<b>true</b>	<b>true</b>
<code>[[AsyncParentModules]]</code>	« »	« <i>A</i> »
<code>[[PendingAsyncDependencies]]</code>	1 ( <i>C</i> )	0
<code>[[EvaluationError]]</code>	empty	<i>C</i> 's evaluation error

*A* will be rejected with the same error as *C* since *C* will call `AsyncModuleExecutionRejected` on *A* with *C*'s error. *A*.[[Status]] is set to evaluated. At this point the Promise in *A*.[[TopLevelCapability]] (which was returned from *A*.Evaluate()) is rejected. The fields of the updated module are as given in Table 52.

Table 52: Module fields after module *A* is rejected

Fields	<i>A</i>
[[DFSIndex]]	0
[[DFSAncestorIndex]]	0
[[Status]]	evaluated
[[AsyncEvaluation]]	true
[[AsyncParentModules]]	« »
[[PendingAsyncDependencies]]	0
[[EvaluationError]]	<i>C</i> 's evaluation error

Then, *B* finishes executing without an error. When that happens, `AsyncModuleExecutionFulfilled` is called again and *B*.[[Status]] is set to evaluated. `GatherAvailableAncestors` is called on *B*. However, *A*.[[CycleRoot]] is *A* which has an evaluation error, so it will not be added to the returned `sortedExecList` and `AsyncModuleExecutionFulfilled` will return without further processing. Any future importer of *B* will resolve the rejection of *B*.[[CycleRoot]].[[EvaluationError]] from the evaluation error from *C* that was set on the cycle root *A*. The fields of the updated modules are as given in Table 53.

Table 53: Module fields after module *B* finishes executing in an erroring graph

Fields	<i>A</i>	<i>B</i>
[[DFSIndex]]	0	1
[[DFSAncestorIndex]]	0	0
[[Status]]	evaluated	evaluated
[[AsyncEvaluation]]	true	true
[[AsyncParentModules]]	« »	« <i>A</i> »
[[PendingAsyncDependencies]]	0	0
[[EvaluationError]]	<i>C</i> 's Evaluation Error	empty

### 16.2.1.6 Source Text Module Records

A *Source Text Module Record* is used to represent information about a module that was defined from ECMAScript source text (11) that was parsed using the `goal symbol Module`. Its fields contain digested

information about the names that are imported by the module and its concrete methods use this digest to link, link, and evaluate the module.

A [Source Text Module Record](#) can exist in a module graph with other subclasses of the abstract [Module Record](#) type, and can participate in cycles with other subclasses of the [Cyclic Module Record](#) type.

In addition to the fields defined in [Table 42](#), [Source Text Module Records](#) have the additional fields listed in [Table 54](#). Each of these fields is initially set in `ParseModule`.

**Table 54: Additional Fields of [Source Text Module Records](#)**

Field Name	Value Type	Meaning
[[ECMAScriptCode]]	a <a href="#">Parse Node</a>	The result of parsing the source text of this module using <i>Module</i> as the <a href="#">goal symbol</a> .
[[Context]]	an <a href="#">ECMAScript code execution context</a> or empty	The <a href="#">execution context</a> associated with this module. It is empty until the module's environment has been initialized.
[[ImportMeta]]	an Object or empty	An object exposed through the <code>import.meta</code> meta property. It is empty until it is accessed by ECMAScript code.
[[ImportEntries]]	a <a href="#">List of ImportEntry Records</a>	A <a href="#">List</a> of <a href="#">ImportEntry</a> records derived from the code of this module.
[[LocalExportEntries]]	a <a href="#">List of ExportEntry Records</a>	A <a href="#">List</a> of <a href="#">ExportEntry</a> records derived from the code of this module that correspond to declarations that occur within the module.
[[IndirectExportEntries]]	a <a href="#">List of ExportEntry Records</a>	A <a href="#">List</a> of <a href="#">ExportEntry</a> records derived from the code of this module that correspond to reexported imports that occur within the module or exports from <code>export * as namespace</code> declarations.
[[StarExportEntries]]	a <a href="#">List of ExportEntry Records</a>	A <a href="#">List</a> of <a href="#">ExportEntry</a> records derived from the code of this module that correspond to <code>export *</code> declarations that occur within the module, not including <code>export * as namespace</code> declarations.

An [ImportEntry Record](#) is a [Record](#) that digests information about a single declarative import. Each [ImportEntry Record](#) has the fields defined in [Table 55](#):

**Table 55: [ImportEntry Record](#) Fields**

Field Name	Value Type	Meaning
[[ModuleRequest]]	a String	String value of the <i>ModuleSpecifier</i> of the <i>ImportDeclaration</i> .
[[ImportName]]	a String or namespace-object	The name under which the desired binding is exported by the module identified by [[ModuleRequest]]. The value namespace-object indicates that the import request is for the target module's namespace object.
[[LocalName]]	a String	The name that is used to locally access the imported value from within the importing module.

NOTE 1 Table 56 gives examples of ImportEntry records fields used to represent the syntactic import forms:

Table 56 (Informative): Import Forms Mappings to ImportEntry Records

Import Statement Form	[[ModuleRequest]]	[[ImportName]]	[[LocalName]]
import v from "mod";	"mod"	"default"	"v"
import * as ns from "mod";	"mod"	namespace-object	"ns"
import {x} from "mod";	"mod"	"x"	"x"
import {x as v} from "mod";	"mod"	"x"	"v"
import "mod";	An ImportEntry Record is not created.		

An ExportEntry Record is a Record that digests information about a single declarative export. Each ExportEntry Record has the fields defined in Table 57:

Table 57: ExportEntry Record Fields

Field Name	Value Type	Meaning
[[ExportName]]	a String or null	The name used to export this binding by this module.
[[ModuleRequest]]	a String or null	The String value of the ModuleSpecifier of the ExportDeclaration. null if the ExportDeclaration does not have a ModuleSpecifier.
[[ImportName]]	a String, null, all, or all-but-default	The name under which the desired binding is exported by the module identified by [[ModuleRequest]]. null if the ExportDeclaration does not have a ModuleSpecifier. all is used for export * as ns from "mod" declarations. all-but-default is used for export * from "mod" declarations.
[[LocalName]]	a String or null	The name that is used to locally access the exported value from within the importing module. null if the exported value is not locally accessible from within the module.

NOTE 2 Table 58 gives examples of the ExportEntry record fields used to represent the syntactic export forms:

Table 58 (Informative): Export Forms Mappings to **ExportEntry Records**

Export Statement Form	[[ExportName]]	[[ModuleRequest]]	[[ImportName]]	[[LocalName]]
export var v;	"v"	null	null	"v"
export default function f() {}	"default"	null	null	"f"
export default function () {}	"default"	null	null	"*default*"
export default 42;	"default"	null	null	"*default*"
export {x};	"x"	null	null	"x"
export {v as x};	"x"	null	null	"v"
export {x} from "mod";	"x"	"mod"	"x"	null
export {v as x} from "mod";	"x"	"mod"	"v"	null
export * from "mod";	null	"mod"	all-but-default	null
export * as ns from "mod";	"ns"	"mod"	all	null

The following definitions specify the required concrete methods and other **abstract operations** for **Source Text Module Records**

#### 16.2.1.6.1 ParseModule ( *sourceText*, *realm*, *hostDefined* )

The abstract operation ParseModule takes arguments *sourceText* (ECMAScript source text), *realm* (a **Realm Record**), and *hostDefined* (anything) and returns a **Source Text Module Record** or a non-empty **List** of **SyntaxError** objects. It creates a **Source Text Module Record** based upon the result of parsing *sourceText* as a *Module*. It performs the following steps when called:

1. Let *body* be **ParseText**(*sourceText*, *Module*).
2. If *body* is a **List** of errors, return *body*.
3. Let *requestedModules* be the **ModuleRequests** of *body*.
4. Let *importEntries* be **ImportEntries** of *body*.
5. Let *importedBoundNames* be **ImportedLocalNames**(*importEntries*).
6. Let *indirectExportEntries* be a new empty **List**.

7. Let *localExportEntries* be a new empty List.
8. Let *starExportEntries* be a new empty List.
9. Let *exportEntries* be *ExportEntries* of *body*.
10. For each *ExportEntry Record ee* of *exportEntries*, do
  - a. If *ee*.[[ModuleRequest]] is **null**, then
    - i. If *importedBoundNames* does not contain *ee*.[[LocalName]], then
      1. Append *ee* to *localExportEntries*.
    - ii. Else,
      1. Let *ie* be the element of *importEntries* whose [[LocalName]] is *ee*.[[LocalName]].
      2. If *ie*.[[ImportName]] is namespace-object, then
        - a. NOTE: This is a re-export of an imported module namespace object.
        - b. Append *ee* to *localExportEntries*.
      3. Else,
        - a. NOTE: This is a re-export of a single name.
        - b. Append the *ExportEntry Record* { [[ModuleRequest]]: *ie*.[[ModuleRequest]], [[ImportName]]: *ie*.[[ImportName]], [[LocalName]]: **null**, [[ExportName]]: *ee*.[[ExportName]] } to *indirectExportEntries*.
  - b. Else if *ee*.[[ImportName]] is all-but-default, then
    - i. **Assert**: *ee*.[[ExportName]] is **null**.
    - ii. Append *ee* to *starExportEntries*.
  - c. Else,
    - i. Append *ee* to *indirectExportEntries*.
11. Let *async* be *body Contains await*.
12. Return *Source Text Module Record* { [[Realm]]: *realm*, [[Environment]]: empty, [[Namespace]]: empty, [[CycleRoot]]: empty, [[HasTLA]]: *async*, [[AsyncEvaluation]]: **false**, [[TopLevelCapability]]: empty, [[AsyncParentModules]]: « », [[PendingAsyncDependencies]]: empty, [[Status]]: new, [[EvaluationError]]: empty, [[HostDefined]]: *hostDefined*, [[ECMAScriptCode]]: *body*, [[Context]]: empty, [[ImportMeta]]: empty, [[RequestedModules]]: *requestedModules*, [[LoadedModules]]: « », [[ImportEntries]]: *importEntries*, [[LocalExportEntries]]: *localExportEntries*, [[IndirectExportEntries]]: *indirectExportEntries*, [[StarExportEntries]]: *starExportEntries*, [[DFSIndex]]: empty, [[DFSAncestorIndex]]: empty }.

**NOTE** An implementation may parse module source text and analyse it for Early Error conditions prior to the evaluation of *ParseModule* for that module source text. However, the reporting of any errors must be deferred until the point where this specification actually performs *ParseModule* upon that source text.

#### 16.2.1.6.2 GetExportedNames ( [ *exportStarSet* ] )

The *GetExportedNames* concrete method of a *Source Text Module Record module* takes optional argument *exportStarSet* (a List of *Source Text Module Records*) and returns a List of either Strings or **null**. It performs the following steps when called:

1. **Assert**: *module*.[[Status]] is not new.
2. If *exportStarSet* is not present, set *exportStarSet* to a new empty List.
3. If *exportStarSet* contains *module*, then
  - a. **Assert**: We've reached the starting point of an **export** \* circularity.
  - b. Return a new empty List.
4. Append *module* to *exportStarSet*.
5. Let *exportedNames* be a new empty List.
6. For each *ExportEntry Record e* of *module*.[[LocalExportEntries]], do
  - a. **Assert**: *module* provides the direct binding for this export.

- b. Append *e*.`[[ExportName]]` to *exportedNames*.
7. For each **ExportEntry Record** *e* of *module*.`[[IndirectExportEntries]]`, do
  - a. **Assert**: *module* imports a specific binding for this export.
  - b. Append *e*.`[[ExportName]]` to *exportedNames*.
8. For each **ExportEntry Record** *e* of *module*.`[[StarExportEntries]]`, do
  - a. Let *requestedModule* be `GetImportedModule(module, e.[[ModuleRequest]])`.
  - b. Let *starNames* be `requestedModule.GetExportedNames(exportStarSet)`.
  - c. For each element *n* of *starNames*, do
    - i. If `SameValue(n, "default")` is **false**, then
      1. If *exportedNames* does not contain *n*, then
        - a. Append *n* to *exportedNames*.
9. Return *exportedNames*.

**NOTE** `GetExportedNames` does not filter out or throw an exception for names that have ambiguous star export bindings.

### 16.2.1.6.3 `ResolveExport ( exportName [ , resolveSet ] )`

The `ResolveExport` concrete method of a **Source Text Module Record** *module* takes argument *exportName* (a String) and optional argument *resolveSet* (a List of Records with fields `[[Module]]` (a **Module Record**) and `[[ExportName]]` (a String)) and returns a **ResolvedBinding Record**, **null**, or ambiguous.

`ResolveExport` attempts to resolve an imported binding to the actual defining module and local binding name. The defining module may be the module represented by the **Module Record** this method was invoked on or some other module that is imported by that module. The parameter *resolveSet* is used to detect unresolved circular import/export paths. If a pair consisting of specific **Module Record** and *exportName* is reached that is already in *resolveSet*, an import circularity has been encountered. Before recursively calling `ResolveExport`, a pair consisting of *module* and *exportName* is added to *resolveSet*.

If a defining module is found, a **ResolvedBinding Record** { `[[Module]]`, `[[BindingName]]` } is returned. This record identifies the resolved binding of the originally requested export, unless this is the export of a namespace with no local binding. In this case, `[[BindingName]]` will be set to namespace. If no definition was found or the request is found to be circular, **null** is returned. If the request is found to be ambiguous, ambiguous is returned.

It performs the following steps when called:

1. **Assert**: *module*.`[[Status]]` is not new.
2. If *resolveSet* is not present, set *resolveSet* to a new empty List.
3. For each **Record** { `[[Module]]`, `[[ExportName]]` } *r* of *resolveSet*, do
  - a. If *module* and *r*.`[[Module]]` are the same **Module Record** and `SameValue(exportName, r.[[ExportName]])` is **true**, then
    - i. **Assert**: This is a circular import request.
    - ii. Return **null**.
4. Append the **Record** { `[[Module]]`: *module*, `[[ExportName]]`: *exportName* } to *resolveSet*.
5. For each **ExportEntry Record** *e* of *module*.`[[LocalExportEntries]]`, do
  - a. If `SameValue(exportName, e.[[ExportName]])` is **true**, then
    - i. **Assert**: *module* provides the direct binding for this export.
    - ii. Return **ResolvedBinding Record** { `[[Module]]`: *module*, `[[BindingName]]`: *e*.`[[LocalName]]` }.

6. For each **ExportEntry Record** *e* of *module*.[[IndirectExportEntries]], do
  - a. If **SameValue**(*exportName*, *e*.[[ExportName]]) is **true**, then
    - i. Let *importedModule* be **GetImportedModule**(*module*, *e*.[[ModuleRequest]]).
    - ii. If *e*.[[ImportName]] is all, then
      1. **Assert**: *module* does not provide the direct binding for this export.
      2. Return **ResolvedBinding Record** { [[Module]]: *importedModule*, [[BindingName]]: *namespace* }.
    - iii. Else,
      1. **Assert**: *module* imports a specific binding for this export.
      2. Return *importedModule*.**ResolveExport**(*e*.[[ImportName]], *resolveSet*).
7. If **SameValue**(*exportName*, "default") is **true**, then
  - a. **Assert**: A **default** export was not explicitly defined by this module.
  - b. Return **null**.
  - c. NOTE: A **default** export cannot be provided by an **export \* from "mod"** declaration.
8. Let *starResolution* be **null**.
9. For each **ExportEntry Record** *e* of *module*.[[StarExportEntries]], do
  - a. Let *importedModule* be **GetImportedModule**(*module*, *e*.[[ModuleRequest]]).
  - b. Let *resolution* be *importedModule*.**ResolveExport**(*exportName*, *resolveSet*).
  - c. If *resolution* is ambiguous, return ambiguous.
  - d. If *resolution* is not **null**, then
    - i. **Assert**: *resolution* is a **ResolvedBinding Record**.
    - ii. If *starResolution* is **null**, set *starResolution* to *resolution*.
    - iii. Else,
      1. **Assert**: There is more than one \* import that includes the requested name.
      2. If *resolution*.[[Module]] and *starResolution*.[[Module]] are not the same **Module Record**, return ambiguous.
      3. If *resolution*.[[BindingName]] is not *starResolution*.[[BindingName]] and either *resolution*.[[BindingName]] or *starResolution*.[[BindingName]] is namespace, return ambiguous.
      4. If *resolution*.[[BindingName]] is a **String**, *starResolution*.[[BindingName]] is a **String**, and **SameValue**(*resolution*.[[BindingName]], *starResolution*.[[BindingName]]) is **false**, return ambiguous.
10. Return *starResolution*.

#### 16.2.1.6.4 InitializeEnvironment ( )

The **InitializeEnvironment** concrete method of a **Source Text Module Record** *module* takes no arguments and returns either a **normal completion** containing unused or a **throw completion**. It performs the following steps when called:

1. For each **ExportEntry Record** *e* of *module*.[[IndirectExportEntries]], do
  - a. Let *resolution* be *module*.**ResolveExport**(*e*.[[ExportName]]).
  - b. If *resolution* is either **null** or ambiguous, throw a **SyntaxError** exception.
  - c. **Assert**: *resolution* is a **ResolvedBinding Record**.
2. **Assert**: All named exports from *module* are resolvable.
3. Let *realm* be *module*.[[Realm]].
4. **Assert**: *realm* is not **undefined**.
5. Let *env* be **NewModuleEnvironment**(*realm*.[[GlobalEnv]]).
6. Set *module*.[[Environment]] to *env*.



7. For each *ImportEntry Record* *in* of *module*.[[*ImportEntries*]], do
  - a. Let *importedModule* be *GetImportedModule*(*module*, *in*.[[*ModuleRequest*]]).
  - b. If *in*.[[*ImportName*]] is namespace-object, then
    - i. Let *namespace* be *GetModuleNamespace*(*importedModule*).
    - ii. Perform ! *env*.*CreateImmutableBinding*(*in*.[[*LocalName*]], **true**).
    - iii. Perform ! *env*.*InitializeBinding*(*in*.[[*LocalName*]], *namespace*).
  - c. Else,
    - i. Let *resolution* be *importedModule*.*ResolveExport*(*in*.[[*ImportName*]]).
    - ii. If *resolution* is either **null** or ambiguous, throw a **SyntaxError** exception.
    - iii. If *resolution*.[[*BindingName*]] is namespace, then
      1. Let *namespace* be *GetModuleNamespace*(*resolution*.[[*Module*]]).
      2. Perform ! *env*.*CreateImmutableBinding*(*in*.[[*LocalName*]], **true**).
      3. Perform ! *env*.*InitializeBinding*(*in*.[[*LocalName*]], *namespace*).
    - iv. Else,
      1. Perform *env*.*CreateImportBinding*(*in*.[[*LocalName*]], *resolution*.[[*Module*]], *resolution*.[[*BindingName*]]).
8. Let *moduleContext* be a new *ECMAScript code execution context*.
9. Set the *Function* of *moduleContext* to **null**.
10. **Assert**: *module*.[[*Realm*]] is not **undefined**.
11. Set the *Realm* of *moduleContext* to *module*.[[*Realm*]].
12. Set the *ScriptOrModule* of *moduleContext* to *module*.
13. Set the *VariableEnvironment* of *moduleContext* to *module*.[[*Environment*]].
14. Set the *LexicalEnvironment* of *moduleContext* to *module*.[[*Environment*]].
15. Set the *PrivateEnvironment* of *moduleContext* to **null**.
16. Set *module*.[[*Context*]] to *moduleContext*.
17. Push *moduleContext* onto the *execution context stack*; *moduleContext* is now the *running execution context*.
18. Let *code* be *module*.[[*ECMAScriptCode*]].
19. Let *varDeclarations* be the *VarScopedDeclarations* of *code*.
20. Let *declaredVarNames* be a new empty *List*.
21. For each element *d* of *varDeclarations*, do
  - a. For each element *dn* of the *BoundNames* of *d*, do
    - i. If *declaredVarNames* does not contain *dn*, then
      1. Perform ! *env*.*CreateMutableBinding*(*dn*, **false**).
      2. Perform ! *env*.*InitializeBinding*(*dn*, **undefined**).
      3. Append *dn* to *declaredVarNames*.
22. Let *lexDeclarations* be the *LexicallyScopedDeclarations* of *code*.
23. Let *privateEnv* be **null**.
24. For each element *d* of *lexDeclarations*, do
  - a. For each element *dn* of the *BoundNames* of *d*, do
    - i. If *IsConstantDeclaration* of *d* is **true**, then
      1. Perform ! *env*.*CreateImmutableBinding*(*dn*, **true**).
    - ii. Else,
      1. Perform ! *env*.*CreateMutableBinding*(*dn*, **false**).
    - iii. If *d* is either a *FunctionDeclaration*, a *GeneratorDeclaration*, an *AsyncFunctionDeclaration*, or an *AsyncGeneratorDeclaration*, then
      1. Let *fo* be *InstantiateFunctionObject* of *d* with arguments *env* and *privateEnv*.
      2. Perform ! *env*.*InitializeBinding*(*dn*, *fo*).
25. Remove *moduleContext* from the *execution context stack*.
26. Return **unused**.

#### 16.2.1.6.5 ExecuteModule ( [ *capability* ] )

The ExecuteModule concrete method of a [Source Text Module Record](#) *module* takes optional argument *capability* (a [PromiseCapability Record](#)) and returns either a [normal completion](#) containing unused or a [throw completion](#). It performs the following steps when called:

1. Let *moduleContext* be a new [ECMAScript code execution context](#).
2. Set the Function of *moduleContext* to **null**.
3. Set the [Realm](#) of *moduleContext* to *module*.[[[Realm](#)]].
4. Set the [ScriptOrModule](#) of *moduleContext* to *module*.
5. **Assert**: *module* has been linked and declarations in its module environment have been instantiated.
6. Set the [VariableEnvironment](#) of *moduleContext* to *module*.[[[Environment](#)]].
7. Set the [LexicalEnvironment](#) of *moduleContext* to *module*.[[[Environment](#)]].
8. Suspend the [running execution context](#).
9. If *module*.[[[HasTLA](#)]] is **false**, then
  - a. **Assert**: *capability* is not present.
  - b. Push *moduleContext* onto the [execution context stack](#); *moduleContext* is now the [running execution context](#).
  - c. Let *result* be [Completion\(Evaluation of \*module\*.\[\[\[ECMAScriptCode\]\(#\)\]\]\)](#).
  - d. Suspend *moduleContext* and remove it from the [execution context stack](#).
  - e. Resume the context that is now on the top of the [execution context stack](#) as the [running execution context](#).
  - f. If *result* is an [abrupt completion](#), then
    - i. Return ? *result*.
10. Else,
  - a. **Assert**: *capability* is a [PromiseCapability Record](#).
  - b. Perform [AsyncBlockStart\(\*capability\*, \*module\*.\[\[\[ECMAScriptCode\]\(#\)\]\], \*moduleContext\*\)](#).
11. Return unused.

#### 16.2.1.7 GetImportedModule ( *referrer*, *specifier* )

The abstract operation GetImportedModule takes arguments *referrer* (a [Cyclic Module Record](#)) and *specifier* (a [String](#)) and returns a [Module Record](#). It performs the following steps when called:

1. **Assert**: Exactly one element of *referrer*.[[[LoadedModules](#)]] is a [Record](#) whose [[[Specifier](#)]] is *specifier*, since [LoadRequestedModules](#) has completed successfully on *referrer* prior to invoking this abstract operation.
2. Let *record* be the [Record](#) in *referrer*.[[[LoadedModules](#)]] whose [[[Specifier](#)]] is *specifier*.
3. Return *record*.[[[Module](#)]].

#### 16.2.1.8 HostLoadImportedModule ( *referrer*, *specifier*, *hostDefined*, *payload* )

The [host-defined](#) abstract operation HostLoadImportedModule takes arguments *referrer* (a [Script Record](#), a [Cyclic Module Record](#), or a [Realm Record](#)), *specifier* (a [String](#)), *hostDefined* (anything), and *payload* (a [GraphLoadingState Record](#) or a [PromiseCapability Record](#)) and returns unused.

**NOTE** An example of when *referrer* can be a *Realm Record* is in a web browser *host*. There, if a user clicks on a control given by

```
<button type="button" onclick="import('./foo.mjs')">Click me</button>
```

there will be no *active script or module* at the time the `import()` expression runs. More generally, this can happen in any situation where the *host* pushes *execution contexts* with *null* *ScriptOrModule* components onto the *execution context stack*.

An implementation of *HostLoadImportedModule* must conform to the following requirements:

- The *host environment* must perform `FinishLoadingImportedModule(referrer, specifier, payload, result)`, where *result* is either a *normal completion* containing the loaded *Module Record* or a *throw completion*, either synchronously or asynchronously.
- If this operation is called multiple times with the same (*referrer*, *specifier*) pair and it performs `FinishLoadingImportedModule(referrer, specifier, payload, result)` where *result* is a *normal completion*, then it must perform `FinishLoadingImportedModule(referrer, specifier, payload, result)` with the same *result* each time.
- The operation must treat *payload* as an opaque value to be passed through to `FinishLoadingImportedModule`.

The actual process performed is *host-defined*, but typically consists of performing whatever I/O operations are necessary to load the appropriate *Module Record*. Multiple different (*referrer*, *specifier*) pairs may map to the same *Module Record* instance. The actual mapping semantics is *host-defined* but typically a normalization process is applied to *specifier* as part of the mapping process. A typical normalization process would include actions such as expansion of relative and abbreviated path specifiers.

### 16.2.1.9 FinishLoadingImportedModule ( *referrer*, *specifier*, *payload*, *result* )

The abstract operation `FinishLoadingImportedModule` takes arguments *referrer* (a *Script Record*, a *Cyclic Module Record*, or a *Realm Record*), *specifier* (a String), *payload* (a *GraphLoadingState Record* or a *PromiseCapability Record*), and *result* (either a *normal completion* containing a *Module Record* or a *throw completion*) and returns unused. It performs the following steps when called:

1. If *result* is a *normal completion*, then
  - a. If *referrer*.`[[LoadedModules]]` contains a *Record* whose `[[Specifier]]` is *specifier*, then
    - i. **Assert:** That *Record*'s `[[Module]]` is *result*.`[[Value]]`.
  - b. Else, append the *Record* { `[[Specifier]]`: *specifier*, `[[Module]]`: *result*.`[[Value]]` } to *referrer*.`[[LoadedModules]]`.
2. If *payload* is a *GraphLoadingState Record*, then
  - a. Perform `ContinueModuleLoading(payload, result)`.
3. Else,
  - a. Perform `ContinueDynamicImport(payload, result)`.
4. Return unused.

### 16.2.1.10 GetModuleNamespace ( *module* )

The abstract operation `GetModuleNamespace` takes argument *module* (an instance of a concrete subclass of *Module Record*) and returns a *Module Namespace Object* or empty. It retrieves the *Module Namespace Object* representing *module*'s exports, lazily creating it the first time it was requested, and storing it in *module*.`[[Namespace]]` for future retrieval. It performs the following steps when called:

1. **Assert:** If *module* is a *Cyclic Module Record*, then *module*.`[[Status]]` is not new or unlinked.
2. Let *namespace* be *module*.`[[Namespace]]`.
3. If *namespace* is empty, then

- a. Let *exportedNames* be *module*.GetExportedNames().
  - b. Let *unambiguousNames* be a new empty List.
  - c. For each element *name* of *exportedNames*, do
    - i. Let *resolution* be *module*.ResolveExport(*name*).
    - ii. If *resolution* is a ResolvedBinding Record, append *name* to *unambiguousNames*.
  - d. Set *namespace* to ModuleNamespaceCreate(*module*, *unambiguousNames*).
4. Return *namespace*.

**NOTE** GetModuleNamespace never throws. Instead, unresolvable names are simply excluded from the namespace at this point. They will lead to a real linking error later unless they are all ambiguous star exports that are not explicitly requested anywhere.

### 16.2.1.11 Runtime Semantics: Evaluation

*Module* : [empty]

1. Return **undefined**.

*ModuleBody* : *ModuleItemList*

1. Let *result* be Completion(Evaluation of *ModuleItemList*).
2. If *result*.[[Type]] is normal and *result*.[[Value]] is empty, then
  - a. Return **undefined**.
3. Return ? *result*.

*ModuleItemList* : *ModuleItemList* *ModuleItem*

1. Let *sl* be ? Evaluation of *ModuleItemList*.
2. Let *s* be Completion(Evaluation of *ModuleItem*).
3. Return ? UpdateEmpty(*s*, *sl*).

**NOTE** The value of a *ModuleItemList* is the value of the last value-producing item in the *ModuleItemList*.

*ModuleItem* : *ImportDeclaration*

1. Return empty.

## 16.2.2 Imports

### Syntax

*ImportDeclaration* :

```
import ImportClause FromClause ;
import ModuleSpecifier ;
```

*ImportClause* :

```
ImportedDefaultBinding
NameSpaceImport
NamedImports
ImportedDefaultBinding , NameSpaceImport
ImportedDefaultBinding , NamedImports
```

*ImportedDefaultBinding* :

```
ImportedBinding
```

*NamespaceImport* :  
     \* **as** *ImportedBinding*

*NamedImports* :  
     { }  
     { *ImportsList* }  
     { *ImportsList* , }

*FromClause* :  
     **from** *ModuleSpecifier*

*ImportsList* :  
     *ImportSpecifier*  
     *ImportsList* , *ImportSpecifier*

*ImportSpecifier* :  
     *ImportedBinding*  
     *ModuleExportName* **as** *ImportedBinding*

*ModuleSpecifier* :  
     *StringLiteral*

*ImportedBinding* :  
     *BindingIdentifier* [*~Yield*, *+Await*]

### 16.2.2.1 Static Semantics: Early Errors

*ModuleItem* : *ImportDeclaration*

- It is a Syntax Error if the [BoundNames](#) of *ImportDeclaration* contains any duplicate entries.

### 16.2.2.2 Static Semantics: ImportEntries

The [syntax-directed operation](#) *ImportEntries* takes no arguments and returns a [List](#) of [ImportEntry Records](#). It is defined piecewise over the following productions:

*Module* : [empty]

1. Return a new empty [List](#).

*ModuleItemList* : *ModuleItemList* *ModuleItem*

1. Let *entries1* be [ImportEntries](#) of *ModuleItemList*.
2. Let *entries2* be [ImportEntries](#) of *ModuleItem*.
3. Return the [list-concatenation](#) of *entries1* and *entries2*.

*ModuleItem* :  
     *ExportDeclaration*  
     *StatementListItem*

1. Return a new empty [List](#).

*ImportDeclaration* : **import** *ImportClause* *FromClause* ;

1. Let *module* be the sole element of [ModuleRequests](#) of *FromClause*.
2. Return [ImportEntriesForModule](#) of *ImportClause* with argument *module*.

*ImportDeclaration* : **import** *ModuleSpecifier* ;

1. Return a new empty [List](#).

### 16.2.2.3 Static Semantics: ImportEntriesForModule

The [syntax-directed operation](#) `ImportEntriesForModule` takes argument *module* (a String) and returns a [List](#) of [ImportEntry Records](#). It is defined piecewise over the following productions:

*ImportClause* : *ImportedDefaultBinding* , *NameSpaceImport*

1. Let *entries1* be `ImportEntriesForModule` of *ImportedDefaultBinding* with argument *module*.
2. Let *entries2* be `ImportEntriesForModule` of *NameSpaceImport* with argument *module*.
3. Return the [list-concatenation](#) of *entries1* and *entries2*.

*ImportClause* : *ImportedDefaultBinding* , *NamedImports*

1. Let *entries1* be `ImportEntriesForModule` of *ImportedDefaultBinding* with argument *module*.
2. Let *entries2* be `ImportEntriesForModule` of *NamedImports* with argument *module*.
3. Return the [list-concatenation](#) of *entries1* and *entries2*.

*ImportedDefaultBinding* : *ImportedBinding*

1. Let *localName* be the sole element of [BoundNames](#) of *ImportedBinding*.
2. Let *defaultEntry* be the [ImportEntry Record](#) { [\[\[ModuleRequest\]\]](#): *module*, [\[\[ImportName\]\]](#): "default", [\[\[LocalName\]\]](#): *localName* }.
3. Return « *defaultEntry* ».

*NameSpaceImport* : \* **as** *ImportedBinding*

1. Let *localName* be the [StringValue](#) of *ImportedBinding*.
2. Let *entry* be the [ImportEntry Record](#) { [\[\[ModuleRequest\]\]](#): *module*, [\[\[ImportName\]\]](#): namespace-object, [\[\[LocalName\]\]](#): *localName* }.
3. Return « *entry* ».

*NamedImports* : { }

1. Return a new empty [List](#).

*ImportsList* : *ImportsList* , *ImportSpecifier*

1. Let *specs1* be the `ImportEntriesForModule` of *ImportsList* with argument *module*.
2. Let *specs2* be the `ImportEntriesForModule` of *ImportSpecifier* with argument *module*.
3. Return the [list-concatenation](#) of *specs1* and *specs2*.

*ImportSpecifier* : *ImportedBinding*

1. Let *localName* be the sole element of [BoundNames](#) of *ImportedBinding*.
2. Let *entry* be the [ImportEntry Record](#) { [\[\[ModuleRequest\]\]](#): *module*, [\[\[ImportName\]\]](#): *localName*, [\[\[LocalName\]\]](#): *localName* }.
3. Return « *entry* ».

*ImportSpecifier* : *ModuleExportName* **as** *ImportedBinding*

1. Let *importName* be the [StringValue](#) of *ModuleExportName*.
2. Let *localName* be the [StringValue](#) of *ImportedBinding*.
3. Let *entry* be the [ImportEntry Record](#) { [\[\[ModuleRequest\]\]](#): *module*, [\[\[ImportName\]\]](#): *importName*, [\[\[LocalName\]\]](#): *localName* }.
4. Return « *entry* ».

### 16.2.3 Exports

#### Syntax

```

ExportDeclaration :
  export ExportFromClause FromClause ;
  export NamedExports ;
  export VariableStatement[~Yield, +Await]
  export Declaration[~Yield, +Await]
  export default HoistableDeclaration[~Yield, +Await, +Default]
  export default ClassDeclaration[~Yield, +Await, +Default]
  export default [lookahead ∉ { function, async [no LineTerminator here] function,
    class }] AssignmentExpression[+In, ~Yield, +Await] ;

```

```

ExportFromClause :
  *
  * as ModuleExportName
  NamedExports

```

```

NamedExports :
  { }
  { ExportsList }
  { ExportsList , }

```

```

ExportsList :
  ExportSpecifier
  ExportsList , ExportSpecifier

```

```

ExportSpecifier :
  ModuleExportName
  ModuleExportName as ModuleExportName

```

#### 16.2.3.1 Static Semantics: Early Errors

*ExportDeclaration* : **export** *NamedExports* ;

- It is a Syntax Error if [ReferencedBindings](#) of *NamedExports* contains any [StringLiterals](#).
- For each *IdentifierName* *n* in [ReferencedBindings](#) of *NamedExports*: It is a Syntax Error if [StringValue](#) of *n* is a [ReservedWord](#) or the [StringValue](#) of *n* is one of "implements", "interface", "let", "package", "private", "protected", "public", or "static".

NOTE The above rule means that each [ReferencedBindings](#) of *NamedExports* is treated as an [IdentifierReference](#).

#### 16.2.3.2 Static Semantics: ExportedBindings

The [syntax-directed operation](#) *ExportedBindings* takes no arguments and returns a [List](#) of Strings.

NOTE ExportedBindings are the locally bound names that are explicitly associated with a *Module's* ExportedNames.

It is defined piecewise over the following productions:

*ModuleItemList* : *ModuleItemList* *ModuleItem*

1. Let *names1* be *ExportedBindings* of *ModuleItemList*.
2. Let *names2* be *ExportedBindings* of *ModuleItem*.
3. Return the list-concatenation of *names1* and *names2*.

*ModuleItem* :

*ImportDeclaration*  
*StatementListItem*

1. Return a new empty *List*.

*ExportDeclaration* :

**export** *ExportFromClause* *FromClause* ;

1. Return a new empty *List*.

*ExportDeclaration* : **export** *NamedExports* ;

1. Return the *ExportedBindings* of *NamedExports*.

*ExportDeclaration* : **export** *VariableStatement*

1. Return the *BoundNames* of *VariableStatement*.

*ExportDeclaration* : **export** *Declaration*

1. Return the *BoundNames* of *Declaration*.

*ExportDeclaration* :

**export default** *HoistableDeclaration*  
**export default** *ClassDeclaration*  
**export default** *AssignmentExpression* ;

1. Return the *BoundNames* of this *ExportDeclaration*.

*NamedExports* : { }

1. Return a new empty *List*.

*ExportsList* : *ExportsList* , *ExportSpecifier*

1. Let *names1* be the *ExportedBindings* of *ExportsList*.
2. Let *names2* be the *ExportedBindings* of *ExportSpecifier*.
3. Return the list-concatenation of *names1* and *names2*.

*ExportSpecifier* : *ModuleExportName*

1. Return a *List* whose sole element is the *StringValue* of *ModuleExportName*.

*ExportSpecifier* : *ModuleExportName* **as** *ModuleExportName*

1. Return a *List* whose sole element is the *StringValue* of the first *ModuleExportName*.



### 16.2.3.3 Static Semantics: ExportedNames

The [syntax-directed operation](#) `ExportedNames` takes no arguments and returns a [List](#) of Strings.

**NOTE** `ExportedNames` are the externally visible names that a *Module* explicitly maps to one of its local name bindings.

It is defined piecewise over the following productions:

*ModuleItemList* : *ModuleItemList* *ModuleItem*

1. Let *names1* be [ExportedNames](#) of *ModuleItemList*.
2. Let *names2* be [ExportedNames](#) of *ModuleItem*.
3. Return the [list-concatenation](#) of *names1* and *names2*.

*ModuleItem* : *ExportDeclaration*

1. Return the [ExportedNames](#) of *ExportDeclaration*.

*ModuleItem* :

*ImportDeclaration*  
*StatementListItem*

1. Return a new empty [List](#).

*ExportDeclaration* : **export** *ExportFromClause* *FromClause* ;

1. Return the [ExportedNames](#) of *ExportFromClause*.

*ExportFromClause* : \*

1. Return a new empty [List](#).

*ExportFromClause* : \* **as** *ModuleExportName*

1. Return a [List](#) whose sole element is the [StringValue](#) of *ModuleExportName*.

*ExportFromClause* : *NamedExports*

1. Return the [ExportedNames](#) of *NamedExports*.

*ExportDeclaration* : **export** *VariableStatement*

1. Return the [BoundNames](#) of *VariableStatement*.

*ExportDeclaration* : **export** *Declaration*

1. Return the [BoundNames](#) of *Declaration*.

*ExportDeclaration* :

**export default** *HoistableDeclaration*  
**export default** *ClassDeclaration*  
**export default** *AssignmentExpression* ;

1. Return « "default" ».

*NamedExports* : { }

1. Return a new empty [List](#).

*ExportsList* : *ExportsList* , *ExportSpecifier*

1. Let *names1* be the [ExportedNames](#) of *ExportsList*.
2. Let *names2* be the [ExportedNames](#) of *ExportSpecifier*.
3. Return the [list-concatenation](#) of *names1* and *names2*.

*ExportSpecifier* : *ModuleExportName*

1. Return a [List](#) whose sole element is the [StringValue](#) of *ModuleExportName*.

*ExportSpecifier* : *ModuleExportName* **as** *ModuleExportName*

1. Return a [List](#) whose sole element is the [StringValue](#) of the second *ModuleExportName*.

### 16.2.3.4 Static Semantics: ExportEntries

The [syntax-directed operation](#) `ExportEntries` takes no arguments and returns a [List](#) of [ExportEntry Records](#). It is defined piecewise over the following productions:

*Module* : [empty]

1. Return a new empty [List](#).

*ModuleItemList* : *ModuleItemList* *ModuleItem*

1. Let *entries1* be [ExportEntries](#) of *ModuleItemList*.
2. Let *entries2* be [ExportEntries](#) of *ModuleItem*.
3. Return the [list-concatenation](#) of *entries1* and *entries2*.

*ModuleItem* :

*ImportDeclaration*  
*StatementListItem*

1. Return a new empty [List](#).

*ExportDeclaration* : **export** *ExportFromClause* *FromClause* ;

1. Let *module* be the sole element of [ModuleRequests](#) of *FromClause*.
2. Return [ExportEntriesForModule](#) of *ExportFromClause* with argument *module*.

*ExportDeclaration* : **export** *NamedExports* ;

1. Return [ExportEntriesForModule](#) of *NamedExports* with argument **null**.

*ExportDeclaration* : **export** *VariableStatement*

1. Let *entries* be a new empty [List](#).
2. Let *names* be the [BoundNames](#) of *VariableStatement*.
3. For each element *name* of *names*, do
  - a. Append the [ExportEntry Record](#) { [\[\[ModuleRequest\]\]](#): **null**, [\[\[ImportName\]\]](#): **null**, [\[\[LocalName\]\]](#): *name*, [\[\[ExportName\]\]](#): *name* } to *entries*.
4. Return *entries*.

*ExportDeclaration* : **export** *Declaration*

1. Let *entries* be a new empty [List](#).

2. Let *names* be the `BoundNames` of *Declaration*.
3. For each element *name* of *names*, do
  - a. Append the `ExportEntry Record` { `[[ModuleRequest]]`: `null`, `[[ImportName]]`: `null`, `[[LocalName]]`: *name*, `[[ExportName]]`: *name* } to *entries*.
4. Return *entries*.

*ExportDeclaration* : **export default** *HoistableDeclaration*

1. Let *names* be `BoundNames` of *HoistableDeclaration*.
2. Let *localName* be the sole element of *names*.
3. Return a `List` whose sole element is a new `ExportEntry Record` { `[[ModuleRequest]]`: `null`, `[[ImportName]]`: `null`, `[[LocalName]]`: *localName*, `[[ExportName]]`: `"default"` }.

*ExportDeclaration* : **export default** *ClassDeclaration*

1. Let *names* be `BoundNames` of *ClassDeclaration*.
2. Let *localName* be the sole element of *names*.
3. Return a `List` whose sole element is a new `ExportEntry Record` { `[[ModuleRequest]]`: `null`, `[[ImportName]]`: `null`, `[[LocalName]]`: *localName*, `[[ExportName]]`: `"default"` }.

*ExportDeclaration* : **export default** *AssignmentExpression* ;

1. Let *entry* be the `ExportEntry Record` { `[[ModuleRequest]]`: `null`, `[[ImportName]]`: `null`, `[[LocalName]]`: `"**default**"`, `[[ExportName]]`: `"default"` }.
2. Return « *entry* ».

**NOTE** `"**default**"` is used within this specification as a synthetic name for anonymous default export values. See [this note](#) for more details.

### 16.2.3.5 Static Semantics: `ExportEntriesForModule`

The `syntax-directed operation` `ExportEntriesForModule` takes argument *module* (a `String` or `null`) and returns a `List` of `ExportEntry Records`. It is defined piecewise over the following productions:

*ExportFromClause* : \*

1. Let *entry* be the `ExportEntry Record` { `[[ModuleRequest]]`: *module*, `[[ImportName]]`: all-but-default, `[[LocalName]]`: `null`, `[[ExportName]]`: `null` }.
2. Return « *entry* ».

*ExportFromClause* : \* **as** *ModuleExportName*

1. Let *exportName* be the `StringValue` of *ModuleExportName*.
2. Let *entry* be the `ExportEntry Record` { `[[ModuleRequest]]`: *module*, `[[ImportName]]`: all, `[[LocalName]]`: `null`, `[[ExportName]]`: *exportName* }.
3. Return « *entry* ».

*NamedExports* : { }

1. Return a new empty `List`.

*ExportsList* : *ExportsList* , *ExportSpecifier*

1. Let *specs1* be the `ExportEntriesForModule` of *ExportsList* with argument *module*.
2. Let *specs2* be the `ExportEntriesForModule` of *ExportSpecifier* with argument *module*.
3. Return the list-concatenation of *specs1* and *specs2*.

*ExportSpecifier* : *ModuleExportName*

1. Let *sourceName* be the `StringValue` of *ModuleExportName*.
2. If *module* is **null**, then
  - a. Let *localName* be *sourceName*.
  - b. Let *importName* be **null**.
3. Else,
  - a. Let *localName* be **null**.
  - b. Let *importName* be *sourceName*.
4. Return a `List` whose sole element is a new `ExportEntry Record` { `[[ModuleRequest]]`: *module*, `[[ImportName]]`: *importName*, `[[LocalName]]`: *localName*, `[[ExportName]]`: *sourceName* }.

*ExportSpecifier* : *ModuleExportName* **as** *ModuleExportName*

1. Let *sourceName* be the `StringValue` of the first *ModuleExportName*.
2. Let *exportName* be the `StringValue` of the second *ModuleExportName*.
3. If *module* is **null**, then
  - a. Let *localName* be *sourceName*.
  - b. Let *importName* be **null**.
4. Else,
  - a. Let *localName* be **null**.
  - b. Let *importName* be *sourceName*.
5. Return a `List` whose sole element is a new `ExportEntry Record` { `[[ModuleRequest]]`: *module*, `[[ImportName]]`: *importName*, `[[LocalName]]`: *localName*, `[[ExportName]]`: *exportName* }.

### 16.2.3.6 Static Semantics: ReferencedBindings

The `syntax-directed operation` `ReferencedBindings` takes no arguments and returns a `List` of `Parse Nodes`. It is defined piecewise over the following productions:

*NamedExports* : { }

1. Return a new empty `List`.

*ExportsList* : *ExportsList* , *ExportSpecifier*

1. Let *names1* be the `ReferencedBindings` of *ExportsList*.
2. Let *names2* be the `ReferencedBindings` of *ExportSpecifier*.
3. Return the list-concatenation of *names1* and *names2*.

*ExportSpecifier* : *ModuleExportName* **as** *ModuleExportName*

1. Return the `ReferencedBindings` of the first *ModuleExportName*.

*ModuleExportName* : *IdentifierName*

1. Return a `List` whose sole element is the *IdentifierName*.

*ModuleExportName* : *StringLiteral*

1. Return a `List` whose sole element is the *StringLiteral*.

### 16.2.3.7 Runtime Semantics: Evaluation

*ExportDeclaration* :

```
export ExportFromClause FromClause ;  
export NamedExports ;
```

1. Return empty.

*ExportDeclaration* : **export** *VariableStatement*

1. Return ? [Evaluation](#) of *VariableStatement*.

*ExportDeclaration* : **export** *Declaration*

1. Return ? [Evaluation](#) of *Declaration*.

*ExportDeclaration* : **export default** *HoistableDeclaration*

1. Return ? [Evaluation](#) of *HoistableDeclaration*.

*ExportDeclaration* : **export default** *ClassDeclaration*

1. Let *value* be ? [BindingClassDeclarationEvaluation](#) of *ClassDeclaration*.
2. Let *className* be the sole element of [BoundNames](#) of *ClassDeclaration*.
3. If *className* is **"default"**, then
  - a. Let *env* be the [running execution context](#)'s [LexicalEnvironment](#).
  - b. Perform ? [InitializeBoundName](#)(**"default"**, *value*, *env*).
4. Return empty.

*ExportDeclaration* : **export default** *AssignmentExpression* ;

1. If [IsAnonymousFunctionDefinition](#)(*AssignmentExpression*) is **true**, then
  - a. Let *value* be ? [NamedEvaluation](#) of *AssignmentExpression* with argument **"default"**.
2. Else,
  - a. Let *rhs* be ? [Evaluation](#) of *AssignmentExpression*.
  - b. Let *value* be ? [GetValue](#)(*rhs*).
3. Let *env* be the [running execution context](#)'s [LexicalEnvironment](#).
4. Perform ? [InitializeBoundName](#)(**"default"**, *value*, *env*).
5. Return empty.

## 17 Error Handling and Language Extensions

An implementation must report most errors at the time the relevant ECMAScript language construct is evaluated. An *early error* is an error that can be detected and reported prior to the evaluation of any construct in the *Script* containing the error. The presence of an [early error](#) prevents the evaluation of the construct. An implementation must report [early errors](#) in a *Script* as part of parsing that *Script* in [ParseScript](#). [Early errors](#) in a *Module* are reported at the point when the *Module* would be evaluated and the *Module* is never initialized. [Early errors](#) in **eval** code are reported at the time **eval** is called and prevent evaluation of the **eval** code. All errors that are not [early errors](#) are runtime errors.

An implementation must report as an [early error](#) any occurrence of a condition that is listed in a "Static Semantics: Early Errors" subclause of this specification.

An implementation shall not treat other kinds of errors as [early errors](#) even if the compiler can prove that a construct cannot execute without error under any circumstances. An implementation may issue an early

warning in such a case, but it should not report the error until the relevant construct is actually executed.

An implementation shall report all errors as specified, except for the following:

- Except as restricted in 17.1, a [host](#) or implementation may extend *Script* syntax, *Module* syntax, and regular expression pattern or flag syntax. To permit this, all operations (such as calling `eval`, using a regular expression literal, or using the `Function` or `RegExp` [constructor](#)) that are allowed to throw **SyntaxError** are permitted to exhibit [host-defined](#) behaviour instead of throwing **SyntaxError** when they encounter a [host-defined](#) extension to the script syntax or regular expression pattern or flag syntax.
- Except as restricted in 17.1, a [host](#) or implementation may provide additional types, values, objects, properties, and functions beyond those described in this specification. This may cause constructs (such as looking up a variable in the global scope) to have [host-defined](#) behaviour instead of throwing an error (such as **ReferenceError**).

## 17.1 Forbidden Extensions

An implementation must not extend this specification in the following ways:

- ECMAScript [function objects](#) defined using syntactic [constructors](#) in [strict mode code](#) must not be created with own properties named **"caller"** or **"arguments"**. Such own properties also must not be created for [function objects](#) defined using an *ArrowFunction*, *MethodDefinition*, *GeneratorDeclaration*, *GeneratorExpression*, *AsyncGeneratorDeclaration*, *AsyncGeneratorExpression*, *ClassDeclaration*, *ClassExpression*, *AsyncFunctionDeclaration*, *AsyncFunctionExpression*, or *AsyncArrowFunction* regardless of whether the definition is contained in [strict mode code](#). Built-in functions, [strict functions](#) created using the `Function` [constructor](#), generator functions created using the `Generator` [constructor](#), async functions created using the `AsyncFunction` [constructor](#), and functions created using the `bind` method also must not be created with such own properties.
- If an implementation extends any [function object](#) with an own property named **"caller"** the value of that property, as observed using `[[Get]]` or `[[GetOwnProperty]]`, must not be a [strict function](#) object. If it is an [accessor property](#), the function that is the value of the property's `[[Get]]` attribute must never return a [strict function](#) when called.
- Neither mapped nor unmapped arguments objects may be created with an own property named **"caller"**.
- The behaviour of built-in methods which are specified in ECMA-402, such as those named **toLocaleString**, must not be extended except as specified in ECMA-402.
- The RegExp pattern grammars in 22.2.1 and B.1.2 must not be extended to recognize any of the source characters A-Z or a-z as *IdentityEscape*<sub>[+UnicodeMode]</sub> when the <sub>[UnicodeMode]</sub> grammar parameter is present.
- The Syntactic Grammar must not be extended in any manner that allows the token `:` to immediately follow source text that is matched by the *BindingIdentifier* nonterminal symbol.
- When processing [strict mode code](#), an implementation must not relax the [early error](#) rules of 12.9.3.1.
- *TemplateEscapeSequence* must not be extended to include *LegacyOctalEscapeSequence* or *NonOctalDecimalEscapeSequence* as defined in 12.9.4.
- When processing [strict mode code](#), the extensions defined in B.3.1, B.3.2, B.3.3, and B.3.5 must not be supported.
- When parsing for the *Module* [goal symbol](#), the lexical grammar extensions defined in B.1.1 must not be supported.
- *ImportCall* must not be extended.

## 18 ECMAScript Standard Built-in Objects

There are certain built-in objects available whenever an ECMAScript *Script* or *Module* begins execution. One, the [global object](#), is part of the global environment of the executing program. Others are accessible as initial properties of the [global object](#) or indirectly as properties of accessible built-in objects.

Unless specified otherwise, a built-in object that is callable as a function is a built-in [function object](#) with the characteristics described in 10.3. Unless specified otherwise, the `[[Extensible]]` internal slot of a built-in object initially has the value **true**. Every built-in [function object](#) has a `[[Realm]]` internal slot whose value is the [Realm Record](#) of the [realm](#) for which the object was initially created.

Many built-in objects are functions: they can be invoked with arguments. Some of them furthermore are **constructors**: they are functions intended for use with the **new** operator. For each built-in function, this specification describes the arguments required by that function and the properties of that **function object**. For each built-in **constructor**, this specification furthermore describes properties of the prototype object of that **constructor** and properties of specific object instances returned by a **new** expression that invokes that **constructor**.

Unless otherwise specified in the description of a particular function, if a built-in function or **constructor** is given fewer arguments than the function is specified to require, the function or **constructor** shall behave exactly as if it had been given sufficient additional arguments, each such argument being the **undefined** value. Such missing arguments are considered to be “not present” and may be identified in that manner by specification algorithms. In the description of a particular function, the terms “**this** value” and “NewTarget” have the meanings given in 10.3.

Unless otherwise specified in the description of a particular function, if a built-in function or **constructor** described is given more arguments than the function is specified to allow, the extra arguments are evaluated by the call and then ignored by the function. However, an implementation may define implementation specific behaviour relating to such arguments as long as the behaviour is not the throwing of a **TypeError** exception that is predicated simply on the presence of an extra argument.

**NOTE 1** Implementations that add additional capabilities to the set of built-in functions are encouraged to do so by adding new functions rather than adding new parameters to existing functions.

Unless otherwise specified every built-in function and every built-in **constructor** has the **Function prototype object**, which is the initial value of the expression **Function.prototype** (20.2.3), as the value of its `[[Prototype]]` internal slot.

Unless otherwise specified every built-in prototype object has the **Object prototype object**, which is the initial value of the expression **Object.prototype** (20.1.3), as the value of its `[[Prototype]]` internal slot, except the **Object prototype object** itself.

Built-in **function objects** that are not identified as **constructors** do not implement the `[[Construct]]` internal method unless otherwise specified in the description of a particular function.

Each built-in function defined in this specification is created by calling the **CreateBuiltinFunction** abstract operation (10.3.3). The values of the *length* and *name* parameters are the initial values of the “**length**” and “**name**” properties as discussed below. The values of the *prefix* parameter are similarly discussed below.

Every built-in **function object**, including **constructors**, has a “**length**” property whose value is a non-negative **integral Number**. Unless otherwise specified, this value is the number of required parameters shown in the subclause heading for the function description. Optional parameters and rest parameters are not included in the parameter count.

**NOTE 2** For example, the **function object** that is the initial value of the “**map**” property of the **Array prototype object** is described under the subclause heading «Array.prototype.map (callbackFn [ , thisArg])» which shows the two named arguments callbackFn and thisArg, the latter being optional; therefore the value of the “**length**” property of that **function object** is 1<sub>F</sub>.

Unless otherwise specified, the “**length**” property of a built-in **function object** has the attributes { `[[Writable]]`: **false**, `[[Enumerable]]`: **false**, `[[Configurable]]`: **true** }.

Every built-in **function object**, including **constructors**, has a “**name**” property whose value is a **String**. Unless otherwise specified, this value is the name that is given to the function in this specification. Functions that are identified as anonymous functions use the empty String as the value of the “**name**” property. For functions that are specified as properties of objects, the name value is the **property name** string used to access the function. Functions that are specified as get or set accessor functions of built-in properties have “**get**” or “**set**” (respectively) passed to the *prefix* parameter when calling **CreateBuiltinFunction**.

The value of the **"name"** property is explicitly specified for each built-in functions whose [property key is a Symbol](#) value. If such an explicitly specified value starts with the prefix **"get "** or **"set "** and the function for which it is specified is a get or set accessor function of a built-in property, the value without the prefix is passed to the [name](#) parameter, and the value **"get"** or **"set"** (respectively) is passed to the [prefix](#) parameter when calling [CreateBuiltinFunction](#).

Unless otherwise specified, the **"name"** property of a built-in [function object](#) has the attributes { [\[\[Writable\]\]](#): **false**, [\[\[Enumerable\]\]](#): **false**, [\[\[Configurable\]\]](#): **true** }.

Every other [data property](#) described in clauses 19 through 28 and in Annex B.2 has the attributes { [\[\[Writable\]\]](#): **true**, [\[\[Enumerable\]\]](#): **false**, [\[\[Configurable\]\]](#): **true** } unless otherwise specified.

Every [accessor property](#) described in clauses 19 through 28 and in Annex B.2 has the attributes { [\[\[Enumerable\]\]](#): **false**, [\[\[Configurable\]\]](#): **true** } unless otherwise specified. If only a get accessor function is described, the set accessor function is the default value, **undefined**. If only a set accessor is described the get accessor is the default value, **undefined**.

## 19 The Global Object

The *global object*:

- is created before control enters any [execution context](#).
- does not have a [\[\[Construct\]\]](#) internal method; it cannot be used as a [constructor](#) with the **new** operator.
- does not have a [\[\[Call\]\]](#) internal method; it cannot be invoked as a function.
- has a [\[\[Prototype\]\]](#) internal slot whose value is [host-defined](#).
- may have [host-defined](#) properties in addition to the properties defined in this specification. This may include a property whose value is the global object itself.

### 19.1 Value Properties of the Global Object

#### 19.1.1 globalThis

The initial value of the **"globalThis"** property of the [global object](#) in a [Realm Record](#) *realm* is *realm*. [\[\[GlobalEnv\]\]](#).[\[\[GlobalThisValue\]\]](#).

This property has the attributes { [\[\[Writable\]\]](#): **true**, [\[\[Enumerable\]\]](#): **false**, [\[\[Configurable\]\]](#): **true** }.

#### 19.1.2 Infinity

The value of **Infinity** is  $+\infty_{\mathbb{F}}$  (see 6.1.6.1). This property has the attributes { [\[\[Writable\]\]](#): **false**, [\[\[Enumerable\]\]](#): **false**, [\[\[Configurable\]\]](#): **false** }.

#### 19.1.3 NaN

The value of **NaN** is **NaN** (see 6.1.6.1). This property has the attributes { [\[\[Writable\]\]](#): **false**, [\[\[Enumerable\]\]](#): **false**, [\[\[Configurable\]\]](#): **false** }.

#### 19.1.4 undefined

The value of **undefined** is **undefined** (see 6.1.1). This property has the attributes { [\[\[Writable\]\]](#): **false**, [\[\[Enumerable\]\]](#): **false**, [\[\[Configurable\]\]](#): **false** }.



## 19.2 Function Properties of the Global Object

### 19.2.1 eval ( x )

This function is the `%eval%` intrinsic object.

It performs the following steps when called:

1. Return ? `PerformEval(x, false, false)`.

#### 19.2.1.1 PerformEval ( x, *strictCaller*, *direct* )

The abstract operation `PerformEval` takes arguments `x` (an ECMAScript language value), `strictCaller` (a Boolean), and `direct` (a Boolean) and returns either a normal completion containing an ECMAScript language value or a throw completion. It performs the following steps when called:

1. **Assert**: If `direct` is **false**, then `strictCaller` is also **false**.
2. If `x` is not a String, return `x`.
3. Let `evalRealm` be the current Realm Record.
4. NOTE: In the case of a **direct eval**, `evalRealm` is the realm of both the caller of `eval` and of the `eval` function itself.
5. Perform ? `HostEnsureCanCompileStrings(evalRealm)`.
6. Let `inFunction` be **false**.
7. Let `inMethod` be **false**.
8. Let `inDerivedConstructor` be **false**.
9. Let `inClassFieldInitializer` be **false**.
10. If `direct` is **true**, then
  - a. Let `thisEnvRec` be `GetThisEnvironment()`.
  - b. If `thisEnvRec` is a Function Environment Record, then
    - i. Let `F` be `thisEnvRec.[[FunctionObject]]`.
    - ii. Set `inFunction` to **true**.
    - iii. Set `inMethod` to `thisEnvRec.HasSuperBinding()`.
    - iv. If `F.[[ConstructorKind]]` is derived, set `inDerivedConstructor` to **true**.
    - v. Let `classFieldInitializerName` be `F.[[ClassFieldInitializerName]]`.
    - vi. If `classFieldInitializerName` is not empty, set `inClassFieldInitializer` to **true**.
11. Perform the following substeps in an implementation-defined order, possibly interleaving parsing and error detection:
  - a. Let `script` be `ParseText(StringToCodePoints(x), Script)`.
  - b. If `script` is a List of errors, throw a **SyntaxError** exception.
  - c. If `script Contains ScriptBody` is **false**, return **undefined**.
  - d. Let `body` be the `ScriptBody` of `script`.
  - e. If `inFunction` is **false** and `body Contains NewTarget`, throw a **SyntaxError** exception.
  - f. If `inMethod` is **false** and `body Contains SuperProperty`, throw a **SyntaxError** exception.
  - g. If `inDerivedConstructor` is **false** and `body Contains SuperCall`, throw a **SyntaxError** exception.
  - h. If `inClassFieldInitializer` is **true** and `ContainsArguments of body` is **true**, throw a **SyntaxError** exception.
12. If `strictCaller` is **true**, let `strictEval` be **true**.
13. Else, let `strictEval` be `IsStrict of script`.
14. Let `runningContext` be the running execution context.

15. NOTE: If *direct* is **true**, *runningContext* will be the **execution context** that performed the **direct eval**. If *direct* is **false**, *runningContext* will be the **execution context** for the invocation of the **eval** function.
16. If *direct* is **true**, then
  - a. Let *lexEnv* be **NewDeclarativeEnvironment**(*runningContext*'s **LexicalEnvironment**).
  - b. Let *varEnv* be *runningContext*'s **VariableEnvironment**.
  - c. Let *privateEnv* be *runningContext*'s **PrivateEnvironment**.
17. Else,
  - a. Let *lexEnv* be **NewDeclarativeEnvironment**(*evalRealm*.[[**GlobalEnv**]]).
  - b. Let *varEnv* be *evalRealm*.[[**GlobalEnv**]].
  - c. Let *privateEnv* be **null**.
18. If *strictEval* is **true**, set *varEnv* to *lexEnv*.
19. If *runningContext* is not already suspended, suspend *runningContext*.
20. Let *evalContext* be a new **ECMAScript code execution context**.
21. Set *evalContext*'s **Function** to **null**.
22. Set *evalContext*'s **Realm** to *evalRealm*.
23. Set *evalContext*'s **ScriptOrModule** to *runningContext*'s **ScriptOrModule**.
24. Set *evalContext*'s **VariableEnvironment** to *varEnv*.
25. Set *evalContext*'s **LexicalEnvironment** to *lexEnv*.
26. Set *evalContext*'s **PrivateEnvironment** to *privateEnv*.
27. Push *evalContext* onto the **execution context stack**; *evalContext* is now the **running execution context**.
28. Let *result* be **Completion**(**EvalDeclarationInstantiation**(*body*, *varEnv*, *lexEnv*, *privateEnv*, *strictEval*)).
29. If *result*.[[**Type**]] is normal, then
  - a. Set *result* to **Completion**(**Evaluation** of *body*).
30. If *result*.[[**Type**]] is normal and *result*.[[**Value**]] is empty, then
  - a. Set *result* to **NormalCompletion**(**undefined**).
31. Suspend *evalContext* and remove it from the **execution context stack**.
32. Resume the context that is now on the top of the **execution context stack** as the **running execution context**.
33. Return ? *result*.

**NOTE** The eval code cannot instantiate variable or function bindings in the variable environment of the calling context that invoked the eval if either the code of the calling context or the eval code is **strict mode code**. Instead such bindings are instantiated in a new **VariableEnvironment** that is only accessible to the eval code. Bindings introduced by **let**, **const**, or **class** declarations are always instantiated in a new **LexicalEnvironment**.

### 19.2.1.2 HostEnsureCanCompileStrings ( *calleeRealm* )

The **host-defined** abstract operation **HostEnsureCanCompileStrings** takes argument *calleeRealm* (a **Realm Record**) and returns either a **normal completion containing unused** or a **throw completion**. It allows **host environments** to block certain ECMAScript functions which allow developers to interpret and evaluate strings as ECMAScript code.

An implementation of **HostEnsureCanCompileStrings** must conform to the following requirements:

- If the returned **Completion Record** is a **normal completion**, it must be a **normal completion containing unused**.

The default implementation of **HostEnsureCanCompileStrings** is to return **NormalCompletion**(unused).

### 19.2.1.3 EvalDeclarationInstantiation ( *body*, *varEnv*, *lexEnv*, *privateEnv*, *strict* )

The abstract operation EvalDeclarationInstantiation takes arguments *body* (a *ScriptBody Parse Node*), *varEnv* (an *Environment Record*), *lexEnv* (a *Declarative Environment Record*), *privateEnv* (a *PrivateEnvironment Record* or **null**), and *strict* (a Boolean) and returns either a *normal completion* containing unused or a *throw completion*. It performs the following steps when called:

1. Let *varNames* be the *VarDeclaredNames* of *body*.
2. Let *varDeclarations* be the *VarScopedDeclarations* of *body*.
3. If *strict* is **false**, then
  - a. If *varEnv* is a *Global Environment Record*, then
    - i. For each element *name* of *varNames*, do
      1. If *varEnv*.*HasLexicalDeclaration*(*name*) is **true**, throw a **SyntaxError** exception.
      2. NOTE: **eval** will not create a global var declaration that would be shadowed by a global lexical declaration.
  - b. Let *thisEnv* be *lexEnv*.
  - c. **Assert**: The following loop will terminate.
  - d. Repeat, while *thisEnv* is not *varEnv*,
    - i. If *thisEnv* is not an *Object Environment Record*, then
      1. NOTE: The environment of with statements cannot contain any lexical declaration so it doesn't need to be checked for var/let hoisting conflicts.
      2. For each element *name* of *varNames*, do
        - a. If ! *thisEnv*.*HasBinding*(*name*) is **true**, then
          - i. Throw a **SyntaxError** exception.
          - ii. NOTE: Annex B.3.4 defines alternate semantics for the above step.
        - b. NOTE: A **direct eval** will not hoist var declaration over a like-named lexical declaration.
      - ii. Set *thisEnv* to *thisEnv*.*[[OuterEnv]]*.
4. Let *privateIdentifiers* be a new empty *List*.
5. Let *pointer* be *privateEnv*.
6. Repeat, while *pointer* is not **null**,
  - a. For each *Private Name binding* of *pointer*.*[[Names]]*, do
    - i. If *privateIdentifiers* does not contain *binding*.*[[Description]]*, append *binding*.*[[Description]]* to *privateIdentifiers*.
  - b. Set *pointer* to *pointer*.*[[OuterPrivateEnvironment]]*.
7. If *AllPrivateIdentifiersValid* of *body* with argument *privateIdentifiers* is **false**, throw a **SyntaxError** exception.
8. Let *functionsToInitialize* be a new empty *List*.
9. Let *declaredFunctionNames* be a new empty *List*.
10. For each element *d* of *varDeclarations*, in reverse *List* order, do
  - a. If *d* is not either a *VariableDeclaration*, a *ForBinding*, or a *BindingIdentifier*, then
    - i. **Assert**: *d* is either a *FunctionDeclaration*, a *GeneratorDeclaration*, an *AsyncFunctionDeclaration*, or an *AsyncGeneratorDeclaration*.
    - ii. NOTE: If there are multiple function declarations for the same name, the last declaration is used.
    - iii. Let *fn* be the sole element of the *BoundNames* of *d*.
    - iv. If *declaredFunctionNames* does not contain *fn*, then
      1. If *varEnv* is a *Global Environment Record*, then
        - a. Let *fnDefinable* be ? *varEnv*.*CanDeclareGlobalFunction*(*fn*).
        - b. If *fnDefinable* is **false**, throw a **TypeError** exception.
      2. Append *fn* to *declaredFunctionNames*.
      3. Insert *d* as the first element of *functionsToInitialize*.

11. NOTE: Annex B.3.2.3 adds additional steps at this point.
12. Let *declaredVarNames* be a new empty List.
13. For each element *d* of *varDeclarations*, do
  - a. If *d* is either a *VariableDeclaration*, a *ForBinding*, or a *BindingIdentifier*, then
    - i. For each String *vn* of the *BoundNames* of *d*, do
      1. If *declaredFunctionNames* does not contain *vn*, then
        - a. If *varEnv* is a *Global Environment Record*, then
          - i. Let *vnDefinable* be ? *varEnv*.CanDeclareGlobalVar(*vn*).
          - ii. If *vnDefinable* is **false**, throw a **TypeError** exception.
        - b. If *declaredVarNames* does not contain *vn*, then
          - i. Append *vn* to *declaredVarNames*.
14. NOTE: No abnormal terminations occur after this algorithm step unless *varEnv* is a *Global Environment Record* and the *global object* is a *Proxy exotic object*.
15. Let *lexDeclarations* be the *LexicallyScopedDeclarations* of *body*.
16. For each element *d* of *lexDeclarations*, do
  - a. NOTE: Lexically declared names are only instantiated here but not initialized.
  - b. For each element *dn* of the *BoundNames* of *d*, do
    - i. If *IsConstantDeclaration* of *d* is **true**, then
      1. Perform ? *lexEnv*.CreateImmutableBinding(*dn*, **true**).
    - ii. Else,
      1. Perform ? *lexEnv*.CreateMutableBinding(*dn*, **false**).
17. For each *Parse Node f* of *functionsToInitialize*, do
  - a. Let *fn* be the sole element of the *BoundNames* of *f*.
  - b. Let *fo* be *InstantiateFunctionObject* of *f* with arguments *lexEnv* and *privateEnv*.
  - c. If *varEnv* is a *Global Environment Record*, then
    - i. Perform ? *varEnv*.CreateGlobalFunctionBinding(*fn*, *fo*, **true**).
  - d. Else,
    - i. Let *bindingExists* be ! *varEnv*.HasBinding(*fn*).
    - ii. If *bindingExists* is **false**, then
      1. NOTE: The following invocation cannot return an *abrupt completion* because of the validation preceding step 14.
      2. Perform ! *varEnv*.CreateMutableBinding(*fn*, **true**).
      3. Perform ! *varEnv*.InitializeBinding(*fn*, *fo*).
    - iii. Else,
      1. Perform ! *varEnv*.SetMutableBinding(*fn*, *fo*, **false**).
18. For each String *vn* of *declaredVarNames*, do
  - a. If *varEnv* is a *Global Environment Record*, then
    - i. Perform ? *varEnv*.CreateGlobalVarBinding(*vn*, **true**).
  - b. Else,
    - i. Let *bindingExists* be ! *varEnv*.HasBinding(*vn*).
    - ii. If *bindingExists* is **false**, then
      1. NOTE: The following invocation cannot return an *abrupt completion* because of the validation preceding step 14.
      2. Perform ! *varEnv*.CreateMutableBinding(*vn*, **true**).
      3. Perform ! *varEnv*.InitializeBinding(*vn*, **undefined**).
19. Return unused.

NOTE An alternative version of this algorithm is described in B.3.4.

### 19.2.2 isFinite ( *number* )

This function is the *%isFinite%* intrinsic object.

It performs the following steps when called:

1. Let *num* be ? [ToNumber](#)(*number*).
2. If *num* is not *finite*, return **false**.
3. Otherwise, return **true**.

### 19.2.3 isNaN ( *number* )

This function is the *%isNaN%* intrinsic object.

It performs the following steps when called:

1. Let *num* be ? [ToNumber](#)(*number*).
2. If *num* is **NaN**, return **true**.
3. Otherwise, return **false**.

**NOTE** A reliable way for ECMAScript code to test if a value **X** is **NaN** is an expression of the form **X !== X**. The result will be **true** if and only if **X** is **NaN**.

### 19.2.4 parseFloat ( *string* )

This function produces a Number value dictated by interpretation of the contents of the *string* argument as a decimal literal.

It is the *%parseFloat%* intrinsic object.

It performs the following steps when called:

1. Let *inputString* be ? [ToString](#)(*string*).
2. Let *trimmedString* be ! [TrimString](#)(*inputString*, start).
3. Let *trimmed* be [StringToCodePoints](#)(*trimmedString*).
4. Let *trimmedPrefix* be the longest prefix of *trimmed* that satisfies the syntax of a *StrDecimalLiteral*, which might be *trimmed* itself. If there is no such prefix, return **NaN**.
5. Let *parsedNumber* be [ParseText](#)(*trimmedPrefix*, *StrDecimalLiteral*).
6. **Assert**: *parsedNumber* is a *Parse Node*.
7. Return [StringNumericValue](#) of *parsedNumber*.

**NOTE** This function may interpret only a leading portion of *string* as a Number value; it ignores any code units that cannot be interpreted as part of the notation of a decimal literal, and no indication is given that any such code units were ignored.

### 19.2.5 parseInt ( *string*, *radix* )

This function produces an *integral Number* dictated by interpretation of the contents of *string* according to the specified *radix*. Leading white space in *string* is ignored. If *radix* coerces to 0 (such as when it is **undefined**), it is assumed to be 10 except when the number representation begins with **"0x"** or **"0X"**, in which case it is assumed to be 16. If *radix* is 16, the number representation may optionally begin with **"0x"** or **"0X"**.

It is the *%parseInt%* intrinsic object.

It performs the following steps when called:

1. Let *inputString* be ? ToString(*string*).
2. Let *S* be ! TrimString(*inputString*, start).
3. Let *sign* be 1.
4. If *S* is not empty and the first code unit of *S* is the code unit 0x002D (HYPHEN-MINUS), set *sign* to -1.
5. If *S* is not empty and the first code unit of *S* is either the code unit 0x002B (PLUS SIGN) or the code unit 0x002D (HYPHEN-MINUS), set *S* to the substring of *S* from index 1.
6. Let *R* be  $\mathbb{R}$ (? ToInt32(*radix*)).
7. Let *stripPrefix* be true.
8. If  $R \neq 0$ , then
  - a. If  $R < 2$  or  $R > 36$ , return NaN.
  - b. If  $R \neq 16$ , set *stripPrefix* to false.
9. Else,
  - a. Set *R* to 10.
10. If *stripPrefix* is true, then
  - a. If the length of *S* is at least 2 and the first two code units of *S* are either "0x" or "0X", then
    - i. Set *S* to the substring of *S* from index 2.
    - ii. Set *R* to 16.
11. If *S* contains a code unit that is not a radix-*R* digit, let *end* be the index within *S* of the first such code unit; otherwise, let *end* be the length of *S*.
12. Let *Z* be the substring of *S* from 0 to *end*.
13. If *Z* is empty, return NaN.
14. Let *mathInt* be the integer value that is represented by *Z* in radix-*R* notation, using the letters **A-Z** and **a-z** for digits with values 10 through 35. (However, if  $R = 10$  and *Z* contains more than 20 significant digits, every significant digit after the 20th may be replaced by a 0 digit, at the option of the implementation; and if *R* is not one of 2, 4, 8, 10, 16, or 32, then *mathInt* may be an implementation-approximated integer representing the integer value denoted by *Z* in radix-*R* notation.)
15. If *mathInt* = 0, then
  - a. If *sign* = -1, return -0<sub>F</sub>.
  - b. Return +0<sub>F</sub>.
16. Return  $\mathbb{F}(\text{sign} \times \text{mathInt})$ .

**NOTE** This function may interpret only a leading portion of *string* as an integer value; it ignores any code units that cannot be interpreted as part of the notation of an integer, and no indication is given that any such code units were ignored.

## 19.2.6 URI Handling Functions

Uniform Resource Identifiers, or URIs, are Strings that identify resources (e.g. web pages or files) and transport protocols by which to access them (e.g. HTTP or FTP) on the Internet. The ECMAScript language itself does not provide any support for using URIs except for functions that encode and decode URIs as described in this section. **encodeURIComponent** and **decodeURIComponent** are intended to work with complete URIs; they assume that any reserved characters are intended to have special meaning (e.g., as delimiters) and so are not encoded. **encodeURIComponent** and **decodeURIComponent** are intended to work with the individual components of a URI; they assume that any reserved characters represent text and must be encoded to avoid special meaning when the component is part of a complete URI.

**NOTE 1** The set of reserved characters is based upon RFC 2396 and does not reflect changes introduced by the more recent RFC 3986.

NOTE 2 Many implementations of ECMAScript provide additional functions and methods that manipulate web pages; these functions are beyond the scope of this standard.

### 19.2.6.1 decodeURI ( *encodedURI* )

This function computes a new version of a URI in which each escape sequence and UTF-8 encoding of the sort that might be introduced by the **encodeURI** function is replaced with the UTF-16 encoding of the code point that it represents. Escape sequences that could not have been introduced by **encodeURI** are not replaced.

It is the *%decodeURI%* intrinsic object.

It performs the following steps when called:

1. Let *uriString* be ? *To*String(*encodedURI*).
2. Let *preserveEscapeSet* be ";/?:@&=+\$,#".
3. Return ? *Decode*(*uriString*, *preserveEscapeSet*).

### 19.2.6.2 decodeURIComponent ( *encodedURIComponent* )

This function computes a new version of a URI in which each escape sequence and UTF-8 encoding of the sort that might be introduced by the **encodeURIComponent** function is replaced with the UTF-16 encoding of the code point that it represents.

It is the *%decodeURIComponent%* intrinsic object.

It performs the following steps when called:

1. Let *componentString* be ? *To*String(*encodedURIComponent*).
2. Let *preserveEscapeSet* be the empty String.
3. Return ? *Decode*(*componentString*, *preserveEscapeSet*).

### 19.2.6.3 encodeURI ( *uri* )

This function computes a new version of a UTF-16 encoded (6.1.4) URI in which each instance of certain code points is replaced by one, two, three, or four escape sequences representing the UTF-8 encoding of the code point.

It is the *%encodeURI%* intrinsic object.

It performs the following steps when called:

1. Let *uriString* be ? *To*String(*uri*).
2. Let *extraUnescaped* be ";/?:@&=+\$,#".
3. Return ? *Encode*(*uriString*, *extraUnescaped*).

### 19.2.6.4 encodeURIComponent ( *uriComponent* )

This function computes a new version of a UTF-16 encoded (6.1.4) URI in which each instance of certain code points is replaced by one, two, three, or four escape sequences representing the UTF-8 encoding of the code point.

It is the *%encodeURIComponent%* intrinsic object.

It performs the following steps when called:

1. Let *componentString* be ? `ToString(uriComponent)`.
2. Let *extraUnescaped* be the empty String.
3. Return ? `Encode(componentString, extraUnescaped)`.

### 19.2.6.5 Encode ( *string*, *extraUnescaped* )

The abstract operation Encode takes arguments *string* (a String) and *extraUnescaped* (a String) and returns either a [normal completion containing](#) a String or a [throw completion](#). It performs URI encoding and escaping, interpreting *string* as a sequence of UTF-16 encoded code points as described in 6.1.4. If a character is identified as unreserved in RFC 2396 or appears in *extraUnescaped*, it is not escaped. It performs the following steps when called:

1. Let *len* be the length of *string*.
2. Let *R* be the empty String.
3. Let *alwaysUnescaped* be the string-concatenation of the ASCII word characters and "-!~\*()'".
4. Let *unescapedSet* be the string-concatenation of *alwaysUnescaped* and *extraUnescaped*.
5. Let *k* be 0.
6. Repeat, while *k* < *len*,
  - a. Let *C* be the code unit at index *k* within *string*.
  - b. If *unescapedSet* contains *C*, then
    - i. Set *k* to *k* + 1.
    - ii. Set *R* to the string-concatenation of *R* and *C*.
  - c. Else,
    - i. Let *cp* be `CodePointAt(string, k)`.
    - ii. If *cp*.[[IsUnpairedSurrogate]] is **true**, throw a **URIError** exception.
    - iii. Set *k* to *k* + *cp*.[[CodeUnitCount]].
    - iv. Let *Octets* be the List of octets resulting by applying the UTF-8 transformation to *cp*.  
[[CodePoint]].
    - v. For each element *octet* of *Octets*, do
      1. Let *hex* be the String representation of *octet*, formatted as an uppercase hexadecimal number.
      2. Set *R* to the string-concatenation of *R*, "%", and ! `StringPad(hex, 2F, "0", start)`.
7. Return *R*.

**NOTE** Because percent-encoding is used to represent individual octets, a single code point may be expressed as multiple consecutive escape sequences (one for each of its 8-bit UTF-8 code units).

### 19.2.6.6 Decode ( *string*, *preserveEscapeSet* )

The abstract operation Decode takes arguments *string* (a String) and *preserveEscapeSet* (a String) and returns either a [normal completion containing](#) a String or a [throw completion](#). It performs URI unescaping and decoding, preserving any escape sequences that correspond to Basic Latin characters in *preserveEscapeSet*. It performs the following steps when called:

1. Let *len* be the length of *string*.
2. Let *R* be the empty String.
3. Let *k* be 0.
4. Repeat, while *k* < *len*,
  - a. Let *C* be the code unit at index *k* within *string*.



- b. Let *S* be *C*.
- c. If *C* is the code unit 0x0025 (PERCENT SIGN), then
  - i. If  $k + 3 > \textit{len}$ , throw a **URIError** exception.
  - ii. Let *escape* be the substring of *string* from *k* to *k* + 3.
  - iii. Let *B* be `ParseHexOctet(string, k + 1)`.
  - iv. If *B* is not an integer, throw a **URIError** exception.
  - v. Set *k* to *k* + 2.
  - vi. Let *n* be the number of leading 1 bits in *B*.
  - vii. If *n* = 0, then
    1. Let *asciiChar* be the code unit whose numeric value is *B*.
    2. If *preserveEscapeSet* contains *asciiChar*, set *S* to *escape*. Otherwise, set *S* to *asciiChar*.
  - viii. Else,
    1. If *n* = 1 or *n* > 4, throw a **URIError** exception.
    2. Let *Octets* be « *B* ».
    3. Let *j* be 1.
    4. Repeat, while *j* < *n*,
      - a. Set *k* to *k* + 1.
      - b. If  $k + 3 > \textit{len}$ , throw a **URIError** exception.
      - c. If the code unit at index *k* within *string* is not the code unit 0x0025 (PERCENT SIGN), throw a **URIError** exception.
      - d. Let *continuationByte* be `ParseHexOctet(string, k + 1)`.
      - e. If *continuationByte* is not an integer, throw a **URIError** exception.
      - f. Append *continuationByte* to *Octets*.
      - g. Set *k* to *k* + 2.
      - h. Set *j* to *j* + 1.
    5. **Assert**: The length of *Octets* is *n*.
    6. If *Octets* does not contain a valid UTF-8 encoding of a Unicode code point, throw a **URIError** exception.
    7. Let *V* be the code point obtained by applying the UTF-8 transformation to *Octets*, that is, from a List of octets into a 21-bit value.
    8. Set *S* to `UTF16EncodeCodePoint(V)`.
  - d. Set *R* to the string-concatenation of *R* and *S*.
  - e. Set *k* to *k* + 1.
5. Return *R*.

**NOTE** RFC 3629 prohibits the decoding of invalid UTF-8 octet sequences. For example, the invalid sequence 0xC0 0x80 must not decode into the code unit 0x0000. Implementations of the Decode algorithm are required to throw a **URIError** when encountering such invalid sequences.

### 19.2.6.7 ParseHexOctet ( *string*, *position* )

The abstract operation ParseHexOctet takes arguments *string* (a String) and *position* (a non-negative integer) and returns either a non-negative integer or a non-empty List of **SyntaxError** objects. It parses a sequence of two hexadecimal characters at the specified *position* in *string* into an unsigned 8-bit integer. It performs the following steps when called:

1. Let *len* be the length of *string*.
2. **Assert**:  $\textit{position} + 2 \leq \textit{len}$ .
3. Let *hexDigits* be the substring of *string* from *position* to *position* + 2.
4. Let *parseResult* be `ParseText(StringToCodePoints(hexDigits), HexDigits[~Sep])`.

5. If *parseResult* is not a *Parse Node*, return *parseResult*.
6. Let *n* be the MV of *parseResult*.
7. *Assert*: *n* is in the *inclusive interval* from 0 to 255.
8. Return *n*.

## 19.3 Constructor Properties of the Global Object

### 19.3.1 AggregateError ( . . . )

See [20.5.7.1](#).

### 19.3.2 Array ( . . . )

See [23.1.1](#).

### 19.3.3 ArrayBuffer ( . . . )

See [25.1.3](#).

### 19.3.4 BigInt ( . . . )

See [21.2.1](#).

### 19.3.5 BigInt64Array ( . . . )

See [23.2.5](#).

### 19.3.6 BigUint64Array ( . . . )

See [23.2.5](#).

### 19.3.7 Boolean ( . . . )

See [20.3.1](#).

### 19.3.8 DataView ( . . . )

See [25.3.2](#).

### 19.3.9 Date ( . . . )

See [21.4.2](#).

### 19.3.10 Error ( . . . )

See [20.5.1](#).

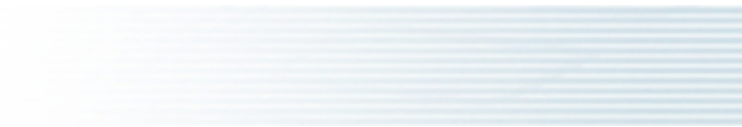

### **19.3.11 EvalError ( . . . )**

See [20.5.5.1](#).

### **19.3.12 FinalizationRegistry ( . . . )**

See [26.2.1](#).

### **19.3.13 Float32Array ( . . . )**

See [23.2.5](#).

### **19.3.14 Float64Array ( . . . )**

See [23.2.5](#).

### **19.3.15 Function ( . . . )**

See [20.2.1](#).

### **19.3.16 Int8Array ( . . . )**

See [23.2.5](#).

### **19.3.17 Int16Array ( . . . )**

See [23.2.5](#).

### **19.3.18 Int32Array ( . . . )**

See [23.2.5](#).

### **19.3.19 Map ( . . . )**

See [24.1.1](#).

### **19.3.20 Number ( . . . )**

See [21.1.1](#).

### **19.3.21 Object ( . . . )**

See [20.1.1](#).



### **19.3.22 Promise ( . . . )**

See [27.2.3](#).

### **19.3.23 Proxy ( . . . )**

See [28.2.1](#).

### **19.3.24 RangeError ( . . . )**

See [20.5.5.2](#).

### **19.3.25 ReferenceError ( . . . )**

See [20.5.5.3](#).

### **19.3.26 RegExp ( . . . )**

See [22.2.4](#).

### **19.3.27 Set ( . . . )**

See [24.2.1](#).

### **19.3.28 SharedArrayBuffer ( . . . )**

See [25.2.2](#).

### **19.3.29 String ( . . . )**

See [22.1.1](#).

### **19.3.30 Symbol ( . . . )**

See [20.4.1](#).

### **19.3.31 SyntaxError ( . . . )**

See [20.5.5.4](#).

### **19.3.32 TypeError ( . . . )**

See [20.5.5.5](#).

### **19.3.33 Uint8Array ( . . . )**

See [23.2.5](#).

### **19.3.34 Uint8ClampedArray ( . . . )**

See [23.2.5](#).

### **19.3.35 Uint16Array ( . . . )**

See [23.2.5](#).

### **19.3.36 Uint32Array ( . . . )**

See [23.2.5](#).

### **19.3.37 URIError ( . . . )**

See [20.5.5.6](#).

### **19.3.38 WeakMap ( . . . )**

See [24.3.1](#).

### **19.3.39 WeakRef ( . . . )**

See [26.1.1](#).

### **19.3.40 WeakSet ( . . . )**

See [24.4](#).

## **19.4 Other Properties of the Global Object**

### **19.4.1 Atomics**

See [25.4](#).

### **19.4.2 JSON**

See [25.5](#).

### **19.4.3 Math**

See [21.3](#).

#### 19.4.4 Reflect

See 28.1.

## 20 Fundamental Objects

### 20.1 Object Objects

#### 20.1.1 The Object Constructor

The Object [constructor](#):

- is *%Object%*.
- is the initial value of the **"Object"** property of the [global object](#).
- creates a new [ordinary object](#) when called as a [constructor](#).
- performs a type conversion when called as a function rather than as a [constructor](#).
- may be used as the value of an **extends** clause of a class definition.

##### 20.1.1.1 Object ( [ *value* ] )

This function performs the following steps when called:

1. If *NewTarget* is neither **undefined** nor the [active function object](#), then
  - a. Return ? [OrdinaryCreateFromConstructor](#)(*NewTarget*, **"%Object.prototype%"**).
2. If *value* is either **undefined** or **null**, return [OrdinaryObjectCreate](#)(*%Object.prototype%*).
3. Return ! [ToObject](#)(*value*).

The **"length"** property of this function is 1<sub>F</sub>.

#### 20.1.2 Properties of the Object Constructor

The Object [constructor](#):

- has a [\[\[Prototype\]\]](#) internal slot whose value is *%Function.prototype%*.
- has a **"length"** property.
- has the following additional properties:

##### 20.1.2.1 Object.assign ( *target*, ...*sources* )

This function copies the values of all of the enumerable own properties from one or more source objects to a [target](#) object.

It performs the following steps when called:

1. Let *to* be ? [ToObject](#)(*target*).
2. If only one argument was passed, return *to*.
3. For each element *nextSource* of *sources*, do
  - a. If *nextSource* is neither **undefined** nor **null**, then

- i. Let *from* be ! **ToObject**(*nextSource*).
- ii. Let *keys* be ? *from*.[[OwnPropertyKeys]]().
- iii. For each element *nextKey* of *keys*, do
  1. Let *desc* be ? *from*.[[GetOwnProperty]](*nextKey*).
  2. If *desc* is not **undefined** and *desc*.[[Enumerable]] is **true**, then
    - a. Let *propValue* be ? **Get**(*from*, *nextKey*).
    - b. Perform ? **Set**(*to*, *nextKey*, *propValue*, **true**).
4. Return *to*.

The "**length**" property of this function is 2<sub>ƒ</sub>.

### 20.1.2.2 Object.create ( *O*, *Properties* )

This function creates a new object with a specified prototype.

It performs the following steps when called:

1. If *O* is not an Object and *O* is not **null**, throw a **TypeError** exception.
2. Let *obj* be **OrdinaryObjectCreate**(*O*).
3. If *Properties* is not **undefined**, then
  - a. Return ? **ObjectDefineProperties**(*obj*, *Properties*).
4. Return *obj*.

### 20.1.2.3 Object.defineProperties ( *O*, *Properties* )

This function adds own properties and/or updates the attributes of existing own properties of an object.

It performs the following steps when called:

1. If *O* is not an Object, throw a **TypeError** exception.
2. Return ? **ObjectDefineProperties**(*O*, *Properties*).

#### 20.1.2.3.1 ObjectDefineProperties ( *O*, *Properties* )

The abstract operation **ObjectDefineProperties** takes arguments *O* (an Object) and *Properties* (an ECMAScript language value) and returns either a normal completion containing an Object or a throw completion. It performs the following steps when called:

1. Let *props* be ? **ToObject**(*Properties*).
2. Let *keys* be ? *props*.[[OwnPropertyKeys]]().
3. Let *descriptors* be a new empty List.
4. For each element *nextKey* of *keys*, do
  - a. Let *propDesc* be ? *props*.[[GetOwnProperty]](*nextKey*).
  - b. If *propDesc* is not **undefined** and *propDesc*.[[Enumerable]] is **true**, then
    - i. Let *descObj* be ? **Get**(*props*, *nextKey*).
    - ii. Let *desc* be ? **ToPropertyDescriptor**(*descObj*).
    - iii. Append the pair (a two element List) consisting of *nextKey* and *desc* to the end of *descriptors*.
5. For each element *pair* of *descriptors*, do
  - a. Let *P* be the first element of *pair*.
  - b. Let *desc* be the second element of *pair*.
  - c. Perform ? **DefinePropertyOrThrow**(*O*, *P*, *desc*).
6. Return *O*.

#### 20.1.2.4 Object.defineProperty ( *O*, *P*, *Attributes* )

This function adds an own property and/or updates the attributes of an existing own property of an object.

It performs the following steps when called:

1. If *O* is not an Object, throw a **TypeError** exception.
2. Let *key* be ? ToPropertyKey(*P*).
3. Let *desc* be ? ToPropertyDescriptor(*Attributes*).
4. Perform ? DefinePropertyOrThrow(*O*, *key*, *desc*).
5. Return *O*.

#### 20.1.2.5 Object.entries ( *O* )

This function performs the following steps when called:

1. Let *obj* be ? ToObject(*O*).
2. Let *entryList* be ? EnumerableOwnProperties(*obj*, key+value).
3. Return CreateArrayFromList(*entryList*).

#### 20.1.2.6 Object.freeze ( *O* )

This function performs the following steps when called:

1. If *O* is not an Object, return *O*.
2. Let *status* be ? SetIntegrityLevel(*O*, frozen).
3. If *status* is **false**, throw a **TypeError** exception.
4. Return *O*.

#### 20.1.2.7 Object.fromEntries ( *iterable* )

This function performs the following steps when called:

1. Perform ? RequireObjectCoercible(*iterable*).
2. Let *obj* be OrdinaryObjectCreate(%Object.prototype%).
3. **Assert:** *obj* is an extensible ordinary object with no own properties.
4. Let *closure* be a new Abstract Closure with parameters (*key*, *value*) that captures *obj* and performs the following steps when called:
  - a. Let *propertyKey* be ? ToPropertyKey(*key*).
  - b. Perform ! CreateDataPropertyOrThrow(*obj*, *propertyKey*, *value*).
  - c. Return **undefined**.
5. Let *adder* be CreateBuiltinFunction(*closure*, 2, "", « »).
6. Return ? AddEntriesFromIterable(*obj*, *iterable*, *adder*).

**NOTE** The function created for *adder* is never directly accessible to ECMAScript code.

#### 20.1.2.8 Object.getOwnPropertyDescriptor ( *O*, *P* )

This function performs the following steps when called:



1. Let *obj* be ? [ToObject](#)(*O*).
2. Let *key* be ? [ToPropertyKey](#)(*P*).
3. Let *desc* be ? *obj*.[[[GetOwnProperty](#)]](*key*).
4. Return [FromPropertyDescriptor](#)(*desc*).

### 20.1.2.9 Object.getOwnPropertyDescriptors ( *O* )

This function performs the following steps when called:

1. Let *obj* be ? [ToObject](#)(*O*).
2. Let *ownKeys* be ? *obj*.[[[OwnPropertyKeys](#)]]().
3. Let *descriptors* be [OrdinaryObjectCreate](#)(%[Object.prototype](#)%).
4. For each element *key* of *ownKeys*, do
  - a. Let *desc* be ? *obj*.[[[GetOwnProperty](#)]](*key*).
  - b. Let *descriptor* be [FromPropertyDescriptor](#)(*desc*).
  - c. If *descriptor* is not **undefined**, perform ! [CreateDataPropertyOrThrow](#)(*descriptors*, *key*, *descriptor*).
5. Return *descriptors*.

### 20.1.2.10 Object.getOwnPropertyNames ( *O* )

This function performs the following steps when called:

1. Return [CreateArrayFromList](#)(? [GetOwnPropertyKeys](#)(*O*, string)).

### 20.1.2.11 Object.getOwnPropertySymbols ( *O* )

This function performs the following steps when called:

1. Return [CreateArrayFromList](#)(? [GetOwnPropertyKeys](#)(*O*, symbol)).

#### 20.1.2.11.1 GetOwnPropertyKeys ( *O*, *type* )

The abstract operation [GetOwnPropertyKeys](#) takes arguments *O* (an [ECMAScript language value](#)) and *type* (string or symbol) and returns either a [normal completion](#) containing a [List](#) of [property keys](#) or a [throw completion](#). It performs the following steps when called:

1. Let *obj* be ? [ToObject](#)(*O*).
2. Let *keys* be ? *obj*.[[[OwnPropertyKeys](#)]]().
3. Let *nameList* be a new empty [List](#).
4. For each element *nextKey* of *keys*, do
  - a. If *nextKey* is a [Symbol](#) and *type* is symbol, or if *nextKey* is a [String](#) and *type* is string, then
    - i. Append *nextKey* to *nameList*.
5. Return *nameList*.

### 20.1.2.12 Object.getPrototypeOf ( *O* )

This function performs the following steps when called:

1. Let *obj* be ? [ToObject](#)(*O*).
2. Return ? *obj*.[[[GetPrototypeOf](#)]]().

### 20.1.2.13 Object.hasOwn ( *O*, *P* )

This function performs the following steps when called:

1. Let *obj* be ? [ToObject](#)(*O*).
2. Let *key* be ? [ToPropertyKey](#)(*P*).
3. Return ? [HasOwnProperty](#)(*obj*, *key*).

### 20.1.2.14 Object.is ( *value1*, *value2* )

This function performs the following steps when called:

1. Return [SameValue](#)(*value1*, *value2*).

### 20.1.2.15 Object.isExtensible ( *O* )

This function performs the following steps when called:

1. If *O* is not an [Object](#), return **false**.
2. Return ? [IsExtensible](#)(*O*).

### 20.1.2.16 Object.isFrozen ( *O* )

This function performs the following steps when called:

1. If *O* is not an [Object](#), return **true**.
2. Return ? [TestIntegrityLevel](#)(*O*, frozen).

### 20.1.2.17 Object.isSealed ( *O* )

This function performs the following steps when called:

1. If *O* is not an [Object](#), return **true**.
2. Return ? [TestIntegrityLevel](#)(*O*, sealed).

### 20.1.2.18 Object.keys ( *O* )

This function performs the following steps when called:

1. Let *obj* be ? [ToObject](#)(*O*).
2. Let *keyList* be ? [EnumerableOwnProperties](#)(*obj*, key).
3. Return [CreateArrayFromList](#)(*keyList*).

### 20.1.2.19 Object.preventExtensions ( *O* )

This function performs the following steps when called:

1. If *O* is not an [Object](#), return *O*.
2. Let *status* be ? *O*.[[PreventExtensions]]().
3. If *status* is **false**, throw a **TypeError** exception.

4. Return `O`.

### 20.1.2.20 `Object.prototype`

The initial value of `Object.prototype` is the [Object prototype object](#).

This property has the attributes { `[[Writable]]`: **false**, `[[Enumerable]]`: **false**, `[[Configurable]]`: **false** }.

### 20.1.2.21 `Object.seal ( O )`

This function performs the following steps when called:

1. If `O` is not an [Object](#), return `O`.
2. Let `status` be `? SetIntegrityLevel(O, sealed)`.
3. If `status` is **false**, throw a **TypeError** exception.
4. Return `O`.

### 20.1.2.22 `Object.setPrototypeOf ( O, proto )`

This function performs the following steps when called:

1. Set `O` to `? RequireObjectCoercible(O)`.
2. If `proto` is not an [Object](#) and `proto` is not **null**, throw a **TypeError** exception.
3. If `O` is not an [Object](#), return `O`.
4. Let `status` be `? O.[[SetPrototypeOf]](proto)`.
5. If `status` is **false**, throw a **TypeError** exception.
6. Return `O`.

### 20.1.2.23 `Object.values ( O )`

This function performs the following steps when called:

1. Let `obj` be `? ToObject(O)`.
2. Let `valueList` be `? EnumerableOwnProperties(obj, value)`.
3. Return `CreateArrayFromList(valueList)`.

## 20.1.3 Properties of the Object Prototype Object

The *Object prototype object*:

- is `%Object.prototype%`.
- has an `[[Extensible]]` internal slot whose value is **true**.
- has the internal methods defined for [ordinary objects](#), except for the `[[SetPrototypeOf]]` method, which is as defined in [10.4.7.1](#). (Thus, it is an [immutable prototype exotic object](#).)
- has a `[[Prototype]]` internal slot whose value is **null**.

### 20.1.3.1 `Object.prototype.constructor`

The initial value of `Object.prototype.constructor` is `%Object%`.

### 20.1.3.2 Object.prototype.hasOwnProperty ( *V* )

This method performs the following steps when called:

1. Let *P* be ? [ToPropertyKey](#)(*V*).
2. Let *O* be ? [ToObject](#)(**this** value).
3. Return ? [HasOwnProperty](#)(*O*, *P*).

**NOTE** The ordering of steps 1 and 2 is chosen to ensure that any exception that would have been thrown by step 1 in previous editions of this specification will continue to be thrown even if the **this** value is **undefined** or **null**.

### 20.1.3.3 Object.prototype.isPrototypeOf ( *V* )

This method performs the following steps when called:

1. If *V* is not an **Object**, return **false**.
2. Let *O* be ? [ToObject](#)(**this** value).
3. Repeat,
  - a. Set *V* to ? *V*.[[[GetPrototypeOf](#)]]().
  - b. If *V* is **null**, return **false**.
  - c. If [SameValue](#)(*O*, *V*) is **true**, return **true**.

**NOTE** The ordering of steps 1 and 2 preserves the behaviour specified by previous editions of this specification for the case where *V* is not an object and the **this** value is **undefined** or **null**.

### 20.1.3.4 Object.prototype.propertyIsEnumerable ( *V* )

This method performs the following steps when called:

1. Let *P* be ? [ToPropertyKey](#)(*V*).
2. Let *O* be ? [ToObject](#)(**this** value).
3. Let *desc* be ? *O*.[[[GetOwnProperty](#)]](*P*).
4. If *desc* is **undefined**, return **false**.
5. Return *desc*.[[[Enumerable](#)]].

**NOTE 1** This method does not consider objects in the prototype chain.

**NOTE 2** The ordering of steps 1 and 2 is chosen to ensure that any exception that would have been thrown by step 1 in previous editions of this specification will continue to be thrown even if the **this** value is **undefined** or **null**.

### 20.1.3.5 Object.prototype.toLocaleString ( [ *reserved1* [ , *reserved2* ] ] )

This method performs the following steps when called:

1. Let *O* be the **this** value.
2. Return ? [Invoke](#)(*O*, "toString").

The optional parameters to this method are not used but are intended to correspond to the parameter pattern used by ECMA-402 **toLocaleString** methods. Implementations that do not include ECMA-402 support must not use those parameter positions for other purposes.

NOTE 1 This method provides a generic **toLocaleString** implementation for objects that have no locale-sensitive **toString** behaviour. **Array**, **Number**, **Date**, and **%TypedArray%** provide their own locale-sensitive **toLocaleString** methods.

NOTE 2 ECMA-402 intentionally does not provide an alternative to this default implementation.

### 20.1.3.6 Object.prototype.toString ( )

This method performs the following steps when called:

1. If the **this** value is **undefined**, return "[object Undefined]".
2. If the **this** value is **null**, return "[object Null]".
3. Let *O* be ! **ToObject**(**this** value).
4. Let *isArray* be ? **isArray**(*O*).
5. If *isArray* is **true**, let *builtinTag* be **"Array"**.
6. Else if *O* has a **[[ParameterMap]]** internal slot, let *builtinTag* be **"Arguments"**.
7. Else if *O* has a **[[Call]]** internal method, let *builtinTag* be **"Function"**.
8. Else if *O* has an **[[ErrorData]]** internal slot, let *builtinTag* be **"Error"**.
9. Else if *O* has a **[[BooleanData]]** internal slot, let *builtinTag* be **"Boolean"**.
10. Else if *O* has a **[[NumberData]]** internal slot, let *builtinTag* be **"Number"**.
11. Else if *O* has a **[[StringData]]** internal slot, let *builtinTag* be **"String"**.
12. Else if *O* has a **[[DateValue]]** internal slot, let *builtinTag* be **"Date"**.
13. Else if *O* has a **[[RegExpMatcher]]** internal slot, let *builtinTag* be **"RegExp"**.
14. Else, let *builtinTag* be **"Object"**.
15. Let *tag* be ? **Get**(*O*, **@@toStringTag**).
16. If *tag* is not a **String**, set *tag* to *builtinTag*.
17. Return the **string-concatenation** of **"[object "**, *tag*, and **"]"**.

NOTE Historically, this method was occasionally used to access the **String** value of the **[[Class]]** internal slot that was used in previous editions of this specification as a nominal type tag for various built-in objects. The above definition of **toString** preserves compatibility for legacy code that uses **toString** as a test for those specific kinds of built-in objects. It does not provide a reliable type testing mechanism for other kinds of built-in or program defined objects. In addition, programs can use **@@toStringTag** in ways that will invalidate the reliability of such legacy type tests.

### 20.1.3.7 Object.prototype.valueOf ( )

This method performs the following steps when called:

1. Return ? **ToObject**(**this** value).

## NORMATIVE OPTIONAL, LEGACY

### 20.1.3.8 Object.prototype.\_\_proto\_\_

`Object.prototype.__proto__` is an [accessor property](#) with attributes { `[[Enumerable]]`: **false**, `[[Configurable]]`: **true** }. The `[[Get]]` and `[[Set]]` attributes are defined as follows:

#### 20.1.3.8.1 get Object.prototype.\_\_proto\_\_

The value of the `[[Get]]` attribute is a built-in function that requires no arguments. It performs the following steps when called:

1. Let *O* be ? [ToObject](#)(**this** value).
2. Return ? *O*.`[[GetPrototypeOf]]`() .

#### 20.1.3.8.2 set Object.prototype.\_\_proto\_\_

The value of the `[[Set]]` attribute is a built-in function that takes an argument *proto*. It performs the following steps when called:

1. Let *O* be ? [RequireObjectCoercible](#)(**this** value).
2. If *proto* is not an [Object](#) and *proto* is not **null**, return **undefined**.
3. If *O* is not an [Object](#), return **undefined**.
4. Let *status* be ? *O*.`[[SetPrototypeOf]]`(*proto*).
5. If *status* is **false**, throw a **TypeError** exception.
6. Return **undefined**.

## NORMATIVE OPTIONAL, LEGACY

### 20.1.3.9 Legacy Object.prototype Accessor Methods

#### 20.1.3.9.1 Object.prototype.\_\_defineGetter\_\_ ( *P*, *getter* )

This method performs the following steps when called:

1. Let *O* be ? [ToObject](#)(**this** value).
2. If [IsCallable](#)(*getter*) is **false**, throw a **TypeError** exception.
3. Let *desc* be [PropertyDescriptor](#) { `[[Get]]`: *getter*, `[[Enumerable]]`: **true**, `[[Configurable]]`: **true** }.
4. Let *key* be ? [ToPropertyKey](#)(*P*).
5. Perform ? [DefinePropertyOrThrow](#)(*O*, *key*, *desc*).
6. Return **undefined**.

#### 20.1.3.9.2 Object.prototype.\_\_defineSetter\_\_ ( *P*, *setter* )

This method performs the following steps when called:

1. Let *O* be ? [ToObject](#)(**this** value).
2. If [IsCallable](#)(*setter*) is **false**, throw a **TypeError** exception.
3. Let *desc* be [PropertyDescriptor](#) { `[[Set]]`: *setter*, `[[Enumerable]]`: **true**, `[[Configurable]]`: **true** }.
4. Let *key* be ? [ToPropertyKey](#)(*P*).

5. Perform ? [DefinePropertyOrThrow\(O, key, desc\)](#).
6. Return **undefined**.

#### 20.1.3.9.3 Object.prototype.\_\_lookupGetter\_\_ ( P )

This method performs the following steps when called:

1. Let *O* be ? [ToObject\(this value\)](#).
2. Let *key* be ? [ToPropertyKey\(P\)](#).
3. Repeat,
  - a. Let *desc* be ? *O*.[[GetOwnProperty]](*key*).
  - b. If *desc* is not **undefined**, then
    - i. If [IsAccessorDescriptor\(desc\)](#) is **true**, return *desc*.[[Get]].
    - ii. Return **undefined**.
  - c. Set *O* to ? *O*.[[GetPrototypeOf]]().
  - d. If *O* is **null**, return **undefined**.

#### 20.1.3.9.4 Object.prototype.\_\_lookupSetter\_\_ ( P )

This method performs the following steps when called:

1. Let *O* be ? [ToObject\(this value\)](#).
2. Let *key* be ? [ToPropertyKey\(P\)](#).
3. Repeat,
  - a. Let *desc* be ? *O*.[[GetOwnProperty]](*key*).
  - b. If *desc* is not **undefined**, then
    - i. If [IsAccessorDescriptor\(desc\)](#) is **true**, return *desc*.[[Set]].
    - ii. Return **undefined**.
  - c. Set *O* to ? *O*.[[GetPrototypeOf]]().
  - d. If *O* is **null**, return **undefined**.

## 20.1.4 Properties of Object Instances

Object instances have no special properties beyond those inherited from the [Object prototype object](#).

## 20.2 Function Objects

### 20.2.1 The Function Constructor

The Function [constructor](#):

- is `%Function%`.
- is the initial value of the **"Function"** property of the [global object](#).
- creates and initializes a new [function object](#) when called as a function rather than as a [constructor](#). Thus the function call `Function(...)` is equivalent to the object creation expression `new Function(...)` with the same arguments.
- may be used as the value of an **extends** clause of a class definition. Subclass [constructors](#) that intend to inherit the specified Function behaviour must include a **super** call to the Function [constructor](#) to create and initialize a subclass instance with the internal slots necessary for built-in function behaviour. All ECMAScript syntactic forms for defining [function objects](#) create instances of Function. There is no

syntactic means to create instances of Function subclasses except for the built-in GeneratorFunction, AsyncFunction, and AsyncGeneratorFunction subclasses.

### 20.2.1.1 Function ( ...*parameterArgs*, *bodyArg* )

The last argument (if any) specifies the body (executable code) of a function; any preceding arguments specify formal parameters.

This function performs the following steps when called:

1. Let *C* be the [active function object](#).
2. If *bodyArg* is not present, set *bodyArg* to the empty String.
3. Return ? [CreateDynamicFunction](#)(*C*, [NewTarget](#), normal, *parameterArgs*, *bodyArg*).

**NOTE** It is permissible but not necessary to have one argument for each formal parameter to be specified. For example, all three of the following expressions produce the same result:

```
new Function("a", "b", "c", "return a+b+c")
new Function("a, b, c", "return a+b+c")
new Function("a,b", "c", "return a+b+c")
```

#### 20.2.1.1.1 CreateDynamicFunction ( *constructor*, *newTarget*, *kind*, *parameterArgs*, *bodyArg* )

The abstract operation [CreateDynamicFunction](#) takes arguments *constructor* (a [constructor](#)), *newTarget* (a [constructor](#)), *kind* (normal, generator, async, or asyncGenerator), *parameterArgs* (a [List of ECMAScript language values](#)), and *bodyArg* (an [ECMAScript language value](#)) and returns either a [normal completion containing a function object](#) or a [throw completion](#). *constructor* is the [constructor](#) function that is performing this action. *newTarget* is the [constructor](#) that [new](#) was initially applied to. *parameterArgs* and *bodyArg* reflect the argument values that were passed to *constructor*. It performs the following steps when called:

1. Let *currentRealm* be the [current Realm Record](#).
2. Perform ? [HostEnsureCanCompileStrings](#)(*currentRealm*).
3. If *newTarget* is **undefined**, set *newTarget* to *constructor*.
4. If *kind* is normal, then
  - a. Let *prefix* be **"function"**.
  - b. Let *exprSym* be the grammar symbol *FunctionExpression*.
  - c. Let *bodySym* be the grammar symbol *FunctionBody*<sub>[~Yield, ~Await]</sub>.
  - d. Let *parameterSym* be the grammar symbol *FormalParameters*<sub>[~Yield, ~Await]</sub>.
  - e. Let *fallbackProto* be **"%Function.prototype%"**.
5. Else if *kind* is generator, then
  - a. Let *prefix* be **"function\*"**.
  - b. Let *exprSym* be the grammar symbol *GeneratorExpression*.
  - c. Let *bodySym* be the grammar symbol *GeneratorBody*.
  - d. Let *parameterSym* be the grammar symbol *FormalParameters*<sub>[+Yield, ~Await]</sub>.
  - e. Let *fallbackProto* be **"%GeneratorFunction.prototype%"**.
6. Else if *kind* is async, then
  - a. Let *prefix* be **"async function"**.
  - b. Let *exprSym* be the grammar symbol *AsyncFunctionExpression*.
  - c. Let *bodySym* be the grammar symbol *AsyncFunctionBody*.
  - d. Let *parameterSym* be the grammar symbol *FormalParameters*<sub>[~Yield, +Await]</sub>.
  - e. Let *fallbackProto* be **"%AsyncFunction.prototype%"**.
7. Else,
  - a. **Assert**: *kind* is asyncGenerator.



- b. Let *prefix* be "async function\*".
- c. Let *exprSym* be the grammar symbol *AsyncGeneratorExpression*.
- d. Let *bodySym* be the grammar symbol *AsyncGeneratorBody*.
- e. Let *parameterSym* be the grammar symbol *FormalParameters*<sub>[+Yield, +Await]</sub>.
- f. Let *fallbackProto* be "%AsyncGeneratorFunction.prototype%".
8. Let *argCount* be the number of elements in *parameterArgs*.
9. Let *P* be the empty String.
10. If *argCount* > 0, then
  - a. Let *firstArg* be *parameterArgs*[0].
  - b. Set *P* to ? ToString(*firstArg*).
  - c. Let *k* be 1.
  - d. Repeat, while *k* < *argCount*,
    - i. Let *nextArg* be *parameterArgs*[ *k* ].
    - ii. Let *nextArgString* be ? ToString(*nextArg*).
    - iii. Set *P* to the string-concatenation of *P*, "," (a comma), and *nextArgString*.
    - iv. Set *k* to *k* + 1.
11. Let *bodyString* be the string-concatenation of 0x000A (LINE FEED), ? ToString(*bodyArg*), and 0x000A (LINE FEED).
12. Let *sourceString* be the string-concatenation of *prefix*, " anonymous(", *P*, 0x000A (LINE FEED), "{", *bodyString*, and "}".
13. Let *sourceText* be ToStringCodePoints(*sourceString*).
14. Let *parameters* be ParseText(ToStringCodePoints(*P*), *parameterSym*).
15. If *parameters* is a List of errors, throw a **SyntaxError** exception.
16. Let *body* be ParseText(ToStringCodePoints(*bodyString*), *bodySym*).
17. If *body* is a List of errors, throw a **SyntaxError** exception.
18. NOTE: The parameters and body are parsed separately to ensure that each is valid alone. For example, **new Function("/\*", "\*/ ) {"** does not evaluate to a function.
19. NOTE: If this step is reached, *sourceText* must have the syntax of *exprSym* (although the reverse implication does not hold). The purpose of the next two steps is to enforce any Early Error rules which apply to *exprSym* directly.
20. Let *expr* be ParseText(*sourceText*, *exprSym*).
21. If *expr* is a List of errors, throw a **SyntaxError** exception.
22. Let *proto* be ? GetPrototypeFromConstructor(*newTarget*, *fallbackProto*).
23. Let *realmF* be the current Realm Record.
24. Let *env* be *realmF*.[[GlobalEnv]].
25. Let *privateEnv* be null.
26. Let *F* be OrdinaryFunctionCreate(*proto*, *sourceText*, *parameters*, *body*, non-lexical-this, *env*, *privateEnv*).
27. Perform SetFunctionName(*F*, "anonymous").
28. If *kind* is generator, then
  - a. Let *prototype* be OrdinaryObjectCreate(%GeneratorFunction.prototype.prototype%).
  - b. Perform ! DefinePropertyOrThrow(*F*, "prototype", PropertyDescriptor { [[Value]]: *prototype*, [[Writable]]: true, [[Enumerable]]: false, [[Configurable]]: false }).
29. Else if *kind* is asyncGenerator, then
  - a. Let *prototype* be OrdinaryObjectCreate(%AsyncGeneratorFunction.prototype.prototype%).
  - b. Perform ! DefinePropertyOrThrow(*F*, "prototype", PropertyDescriptor { [[Value]]: *prototype*, [[Writable]]: true, [[Enumerable]]: false, [[Configurable]]: false }).
30. Else if *kind* is normal, perform MakeConstructor(*F*).
31. NOTE: Functions whose *kind* is async are not constructible and do not have a [[Construct]] internal method or a "prototype" property.
32. Return *F*.

NOTE CreateDynamicFunction defines a **"prototype"** property on any function it creates whose *kind* is not `async` to provide for the possibility that the function will be used as a [constructor](#).

## 20.2.2 Properties of the Function Constructor

The Function [constructor](#):

- is itself a built-in [function object](#).
- has a `[[Prototype]]` internal slot whose value is `%Function.prototype%`.
- has the following properties:

### 20.2.2.1 Function.length

This is a [data property](#) with a value of 1. This property has the attributes { `[[Writable]]`: **false**, `[[Enumerable]]`: **false**, `[[Configurable]]`: **true** }.

### 20.2.2.2 Function.prototype

The value of `Function.prototype` is the [Function prototype object](#).

This property has the attributes { `[[Writable]]`: **false**, `[[Enumerable]]`: **false**, `[[Configurable]]`: **false** }.

## 20.2.3 Properties of the Function Prototype Object

The *Function prototype object*:

- is `%Function.prototype%`.
- is itself a built-in [function object](#).
- accepts any arguments and returns **undefined** when invoked.
- does not have a `[[Construct]]` internal method; it cannot be used as a [constructor](#) with the **new** operator.
- has a `[[Prototype]]` internal slot whose value is `%Object.prototype%`.
- does not have a **"prototype"** property.
- has a **"length"** property whose value is `+0`<sub>F</sub>.
- has a **"name"** property whose value is the empty String.

NOTE The Function prototype object is specified to be a [function object](#) to ensure compatibility with ECMAScript code that was created prior to the ECMAScript 2015 specification.

### 20.2.3.1 Function.prototype.apply ( *thisArg*, *argArray* )

This method performs the following steps when called:

1. Let *func* be the **this** value.
2. If `IsCallable(func)` is **false**, throw a **TypeError** exception.
3. If *argArray* is either **undefined** or **null**, then
  - a. Perform `PrepareForTailCall()`.
  - b. Return ? `Call(func, thisArg)`.
4. Let *argList* be ? `CreateListFromArrayLike(argArray)`.
5. Perform `PrepareForTailCall()`.
6. Return ? `Call(func, thisArg, argList)`.

NOTE 1 The *thisArg* value is passed without modification as the **this** value. This is a change from Edition 3, where an **undefined** or **null** *thisArg* is replaced with the **global object** and **ToObject** is applied to all other values and that result is passed as the **this** value. Even though the *thisArg* is passed without modification, **non-strict functions** still perform these transformations upon entry to the function.

NOTE 2 If *func* is either an arrow function or a **bound function exotic object**, then the *thisArg* will be ignored by the function **[[Call]]** in step 6.

### 20.2.3.2 **Function.prototype.bind** ( *thisArg*, ...*args* )

This method performs the following steps when called:

1. Let *Target* be the **this** value.
2. If **IsCallable**(*Target*) is **false**, throw a **TypeError** exception.
3. Let *F* be ? **BoundFunctionCreate**(*Target*, *thisArg*, *args*).
4. Let *L* be 0.
5. Let *targetHasLength* be ? **HasOwnProperty**(*Target*, "length").
6. If *targetHasLength* is **true**, then
  - a. Let *targetLen* be ? **Get**(*Target*, "length").
  - b. If *targetLen* is a **Number**, then
    - i. If *targetLen* is  $+\infty_{\mathbb{P}}$ , set *L* to  $+\infty$ .
    - ii. Else if *targetLen* is  $-\infty_{\mathbb{P}}$ , set *L* to 0.
    - iii. Else,
      1. Let *targetLenAsInt* be ! **ToIntegerOrInfinity**(*targetLen*).
      2. **Assert**: *targetLenAsInt* is finite.
      3. Let *argCount* be the number of elements in *args*.
      4. Set *L* to **max**(*targetLenAsInt* - *argCount*, 0).
7. Perform **SetFunctionLength**(*F*, *L*).
8. Let *targetName* be ? **Get**(*Target*, "name").
9. If *targetName* is not a **String**, set *targetName* to the empty **String**.
10. Perform **SetFunctionName**(*F*, *targetName*, "bound").
11. Return *F*.

NOTE 1 **Function objects** created using **Function.prototype.bind** are **exotic objects**. They also do not have a **"prototype"** property.

NOTE 2 If *Target* is either an arrow function or a **bound function exotic object**, then the *thisArg* passed to this method will not be used by subsequent calls to *F*.

### 20.2.3.3 **Function.prototype.call** ( *thisArg*, ...*args* )

This method performs the following steps when called:

1. Let *func* be the **this** value.
2. If **IsCallable**(*func*) is **false**, throw a **TypeError** exception.
3. Perform **PrepareForTailCall**().
4. Return ? **Call**(*func*, *thisArg*, *args*).

NOTE 1 The *thisArg* value is passed without modification as the **this** value. This is a change from Edition 3, where an **undefined** or **null** *thisArg* is replaced with the **global object** and **ToObject** is applied to all other values and that result is passed as the **this** value. Even though the *thisArg* is passed without modification, **non-strict functions** still perform these transformations upon entry to the function.

NOTE 2 If *func* is either an arrow function or a **bound function exotic object**, then the *thisArg* will be ignored by the function `[[Call]]` in step 4.

### 20.2.3.4 Function.prototype.constructor

The initial value of `Function.prototype.constructor` is `%Function%`.

### 20.2.3.5 Function.prototype.toString ( )

This method performs the following steps when called:

1. Let *func* be the **this** value.
2. If *func* is an **Object**, *func* has a `[[SourceText]]` internal slot, *func*.`[[SourceText]]` is a sequence of Unicode code points, and `HostHasSourceTextAvailable(func)` is **true**, then
  - a. Return `CodePointsToString(func.[[SourceText]])`.
3. If *func* is a **built-in function object**, return an **implementation-defined** String source code representation of *func*. The representation must have the syntax of a *NativeFunction*. Additionally, if *func* has an `[[InitialName]]` internal slot and *func*.`[[InitialName]]` is a **String**, the portion of the returned String that would be matched by `NativeFunctionAccessoropt PropertyName` must be the value of *func*.`[[InitialName]]`.
4. If *func* is an **Object** and `IsCallable(func)` is **true**, return an **implementation-defined** String source code representation of *func*. The representation must have the syntax of a *NativeFunction*.
5. Throw a **TypeError** exception.

*NativeFunction* :

```
function NativeFunctionAccessoropt PropertyName[~Yield, ~Await]opt (
  FormalParameters[~Yield, ~Await] ) { [ native code ] }
```

*NativeFunctionAccessor* :

```
get
set
```

### 20.2.3.6 Function.prototype [ @@hasInstance ] ( V )

This method performs the following steps when called:

1. Let *F* be the **this** value.
2. Return ? `OrdinaryHasInstance(F, V)`.

This property has the attributes { `[[Writable]]`: **false**, `[[Enumerable]]`: **false**, `[[Configurable]]`: **false** }.

NOTE This is the default implementation of `@@hasInstance` that most functions inherit. `@@hasInstance` is called by the `instanceof` operator to determine whether a value is an instance of a specific `constructor`. An expression such as

```
v instanceof F
```

evaluates as

```
F[@@hasInstance](v)
```

A `constructor` function can control which objects are recognized as its instances by `instanceof` by exposing a different `@@hasInstance` method on the function.

This property is non-writable and non-configurable to prevent tampering that could be used to globally expose the target function of a bound function.

The value of the `"name"` property of this method is `"[Symbol.hasInstance]"`.

## 20.2.4 Function Instances

Every Function instance is an ECMAScript `function object` and has the internal slots listed in [Table 30](#). `Function objects` created using the `Function.prototype.bind` method ([20.2.3.2](#)) have the internal slots listed in [Table 31](#).

Function instances have the following properties:

### 20.2.4.1 length

The value of the `"length"` property is an `integral Number` that indicates the typical number of arguments expected by the function. However, the language permits the function to be invoked with some other number of arguments. The behaviour of a function when invoked on a number of arguments other than the number specified by its `"length"` property depends on the function. This property has the attributes { `[[Writable]]`: `false`, `[[Enumerable]]`: `false`, `[[Configurable]]`: `true` }.

### 20.2.4.2 name

The value of the `"name"` property is a `String` that is descriptive of the function. The name has no semantic significance but is typically a variable or `property name` that is used to refer to the function at its point of definition in [ECMAScript source text](#). This property has the attributes { `[[Writable]]`: `false`, `[[Enumerable]]`: `false`, `[[Configurable]]`: `true` }.

Anonymous functions objects that do not have a contextual name associated with them by this specification use the empty `String` as the value of the `"name"` property.

### 20.2.4.3 prototype

Function instances that can be used as a `constructor` have a `"prototype"` property. Whenever such a Function instance is created another `ordinary object` is also created and is the initial value of the function's `"prototype"` property. Unless otherwise specified, the value of the `"prototype"` property is used to initialize the `[[Prototype]]` internal slot of the object created when that function is invoked as a `constructor`.

This property has the attributes { `[[Writable]]`: `true`, `[[Enumerable]]`: `false`, `[[Configurable]]`: `false` }.

NOTE [Function objects](#) created using `Function.prototype.bind`, or by evaluating a *MethodDefinition* (that is not a *GeneratorMethod* or *AsyncGeneratorMethod*) or an *ArrowFunction* do not have a **"prototype"** property.

### 20.2.5 HostHasSourceTextAvailable ( *func* )

The [host-defined](#) abstract operation `HostHasSourceTextAvailable` takes argument *func* (a [function object](#)) and returns a Boolean. It allows [host environments](#) to prevent the source text from being provided for *func*.

An implementation of `HostHasSourceTextAvailable` must conform to the following requirements:

- It must be deterministic with respect to its parameters. Each time it is called with a specific *func* as its argument, it must return the same result.

The default implementation of `HostHasSourceTextAvailable` is to return **true**.

## 20.3 Boolean Objects

### 20.3.1 The Boolean Constructor

The Boolean [constructor](#):

- is `%Boolean%`.
- is the initial value of the **"Boolean"** property of the [global object](#).
- creates and initializes a new Boolean object when called as a [constructor](#).
- performs a type conversion when called as a function rather than as a [constructor](#).
- may be used as the value of an **extends** clause of a class definition. Subclass [constructors](#) that intend to inherit the specified Boolean behaviour must include a **super** call to the Boolean [constructor](#) to create and initialize the subclass instance with a `[[BooleanData]]` internal slot.

#### 20.3.1.1 Boolean ( *value* )

This function performs the following steps when called:

1. Let *b* be `ToBoolean(value)`.
2. If `NewTarget` is **undefined**, return *b*.
3. Let *O* be `? OrdinaryCreateFromConstructor(NewTarget, "%Boolean.prototype%", « [[BooleanData]] »)`.
4. Set `O.[[BooleanData]]` to *b*.
5. Return *O*.

### 20.3.2 Properties of the Boolean Constructor

The Boolean [constructor](#):

- has a `[[Prototype]]` internal slot whose value is `%Function.prototype%`.
- has the following properties:

#### 20.3.2.1 Boolean.prototype

The initial value of `Boolean.prototype` is the [Boolean prototype object](#).

This property has the attributes { `[[Writable]]`: **false**, `[[Enumerable]]`: **false**, `[[Configurable]]`: **false** }.

### 20.3.3 Properties of the Boolean Prototype Object

The *Boolean prototype object*:

- is `%Boolean.prototype%`.
- is an [ordinary object](#).
- is itself a Boolean object; it has a `[[BooleanData]]` internal slot with the value **false**.
- has a `[[Prototype]]` internal slot whose value is `%Object.prototype%`.

The abstract operation `thisBooleanValue` takes argument `value`. It performs the following steps when called:

1. If `value` is a Boolean, return `value`.
2. If `value` is an Object and `value` has a `[[BooleanData]]` internal slot, then
  - a. Let `b` be `value.[[BooleanData]]`.
  - b. Assert: `b` is a Boolean.
  - c. Return `b`.
3. Throw a **TypeError** exception.

#### 20.3.3.1 Boolean.prototype.constructor

The initial value of `Boolean.prototype.constructor` is `%Boolean%`.

#### 20.3.3.2 Boolean.prototype.toString ( )

This method performs the following steps when called:

1. Let `b` be ? `thisBooleanValue(this value)`.
2. If `b` is **true**, return **"true"**; else return **"false"**.

#### 20.3.3.3 Boolean.prototype.valueOf ( )

This method performs the following steps when called:

1. Return ? `thisBooleanValue(this value)`.

### 20.3.4 Properties of Boolean Instances

Boolean instances are [ordinary objects](#) that inherit properties from the [Boolean prototype object](#). Boolean instances have a `[[BooleanData]]` internal slot. The `[[BooleanData]]` internal slot is the Boolean value represented by this Boolean object.

## 20.4 Symbol Objects

### 20.4.1 The Symbol Constructor

The Symbol [constructor](#):

- is `%Symbol%`.

- is the initial value of the **"Symbol"** property of the [global object](#).
- returns a new Symbol value when called as a function.
- is not intended to be used with the **new** operator.
- is not intended to be subclassed.
- may be used as the value of an **extends** clause of a class definition but a **super** call to it will cause an exception.

### 20.4.1.1 Symbol ( [ *description* ] )

This function performs the following steps when called:

1. If *NewTarget* is not **undefined**, throw a **TypeError** exception.
2. If *description* is **undefined**, let *descString* be **undefined**.
3. Else, let *descString* be ? [ToString](#)(*description*).
4. Return a new Symbol whose [\[\[Description\]\]](#) is *descString*.

## 20.4.2 Properties of the Symbol Constructor

The Symbol [constructor](#):

- has a [\[\[Prototype\]\]](#) internal slot whose value is [%Function.prototype%](#).
- has the following properties:

### 20.4.2.1 Symbol.asyncIterator

The initial value of [Symbol.prototype.asyncIterator](#) is the well known symbol [@@asyncIterator](#) ([Table 1](#)).

This property has the attributes { [\[\[Writable\]\]](#): **false**, [\[\[Enumerable\]\]](#): **false**, [\[\[Configurable\]\]](#): **false** }.

### 20.4.2.2 Symbol.for ( *key* )

This function performs the following steps when called:

1. Let *stringKey* be ? [ToString](#)(*key*).
2. For each element *e* of the [GlobalSymbolRegistry List](#), do
  - a. If [SameValue](#)(*e*.[\[\[Key\]\]](#), *stringKey*) is **true**, return *e*.[\[\[Symbol\]\]](#).
3. **Assert**: [GlobalSymbolRegistry](#) does not currently contain an entry for *stringKey*.
4. Let *newSymbol* be a new Symbol whose [\[\[Description\]\]](#) is *stringKey*.
5. Append the [Record](#) { [\[\[Key\]\]](#): *stringKey*, [\[\[Symbol\]\]](#): *newSymbol* } to the [GlobalSymbolRegistry List](#).
6. Return *newSymbol*.

The [GlobalSymbolRegistry](#) is an append-only [List](#) that is globally available. It is shared by all [realms](#). Prior to the evaluation of any ECMAScript code, it is initialized as a new empty [List](#). Elements of the [GlobalSymbolRegistry](#) are [Records](#) with the structure defined in [Table 59](#).

**Table 59: GlobalSymbolRegistry Record Fields**

Field Name	Value	Usage
<a href="#">[[Key]]</a>	a String	A string key used to globally identify a Symbol.
<a href="#">[[Symbol]]</a>	a Symbol	A symbol that can be retrieved from any <a href="#">realm</a> .



### 20.4.2.3 Symbol.hasInstance

The initial value of `Symbol.hasInstance` is the well-known symbol `@@hasInstance` (Table 1).

This property has the attributes { `[[Writable]]`: **false**, `[[Enumerable]]`: **false**, `[[Configurable]]`: **false** }.

### 20.4.2.4 Symbol.isConcatSpreadable

The initial value of `Symbol.isConcatSpreadable` is the well-known symbol `@@isConcatSpreadable` (Table 1).

This property has the attributes { `[[Writable]]`: **false**, `[[Enumerable]]`: **false**, `[[Configurable]]`: **false** }.

### 20.4.2.5 Symbol.iterator

The initial value of `Symbol.iterator` is the well-known symbol `@@iterator` (Table 1).

This property has the attributes { `[[Writable]]`: **false**, `[[Enumerable]]`: **false**, `[[Configurable]]`: **false** }.

### 20.4.2.6 Symbol.keyFor ( *sym* )

This function performs the following steps when called:

1. If *sym* is not a `Symbol`, throw a **TypeError** exception.
2. Return `KeyForSymbol(sym)`.

### 20.4.2.7 Symbol.match

The initial value of `Symbol.match` is the well-known symbol `@@match` (Table 1).

This property has the attributes { `[[Writable]]`: **false**, `[[Enumerable]]`: **false**, `[[Configurable]]`: **false** }.

### 20.4.2.8 Symbol.matchAll

The initial value of `Symbol.matchAll` is the well-known symbol `@@matchAll` (Table 1).

This property has the attributes { `[[Writable]]`: **false**, `[[Enumerable]]`: **false**, `[[Configurable]]`: **false** }.

### 20.4.2.9 Symbol.prototype

The initial value of `Symbol.prototype` is the `Symbol prototype object`.

This property has the attributes { `[[Writable]]`: **false**, `[[Enumerable]]`: **false**, `[[Configurable]]`: **false** }.

### 20.4.2.10 Symbol.replace

The initial value of `Symbol.replace` is the well-known symbol `@@replace` (Table 1).

This property has the attributes { `[[Writable]]`: **false**, `[[Enumerable]]`: **false**, `[[Configurable]]`: **false** }.

#### 20.4.2.11 Symbol.search

The initial value of `Symbol.prototype.search` is the well-known symbol `@@search` (Table 1).

This property has the attributes { `[[Writable]]`: **false**, `[[Enumerable]]`: **false**, `[[Configurable]]`: **false** }.

#### 20.4.2.12 Symbol.species

The initial value of `Symbol.prototype.species` is the well-known symbol `@@species` (Table 1).

This property has the attributes { `[[Writable]]`: **false**, `[[Enumerable]]`: **false**, `[[Configurable]]`: **false** }.

#### 20.4.2.13 Symbol.split

The initial value of `Symbol.prototype.split` is the well-known symbol `@@split` (Table 1).

This property has the attributes { `[[Writable]]`: **false**, `[[Enumerable]]`: **false**, `[[Configurable]]`: **false** }.

#### 20.4.2.14 Symbol.toPrimitive

The initial value of `Symbol.prototype.toPrimitive` is the well-known symbol `@@toPrimitive` (Table 1).

This property has the attributes { `[[Writable]]`: **false**, `[[Enumerable]]`: **false**, `[[Configurable]]`: **false** }.

#### 20.4.2.15 Symbol.toStringTag

The initial value of `Symbol.prototype.toStringTag` is the well-known symbol `@@toStringTag` (Table 1).

This property has the attributes { `[[Writable]]`: **false**, `[[Enumerable]]`: **false**, `[[Configurable]]`: **false** }.

#### 20.4.2.16 Symbol.unscopables

The initial value of `Symbol.prototype.unscopables` is the well-known symbol `@@unscopables` (Table 1).

This property has the attributes { `[[Writable]]`: **false**, `[[Enumerable]]`: **false**, `[[Configurable]]`: **false** }.

### 20.4.3 Properties of the Symbol Prototype Object

The *Symbol prototype object*:

- is `%Symbol.prototype%`.
- is an **ordinary object**.
- is **not a Symbol** instance and does not have a `[[SymbolData]]` internal slot.
- has a `[[Prototype]]` internal slot whose value is `%Object.prototype%`.

The abstract operation *thisSymbolValue* takes argument *value*. It performs the following steps when called:

1. If *value* is a **Symbol**, return *value*.
2. If *value* is an **Object** and *value* has a `[[SymbolData]]` internal slot, then
  - a. Let *s* be *value*.`[[SymbolData]]`.
  - b. **Assert**: *s* is a **Symbol**.
  - c. Return *s*.
3. Throw a **TypeError** exception.

### 20.4.3.1 Symbol.prototype.constructor

The initial value of `Symbol.prototype.constructor` is `%Symbol%`.

### 20.4.3.2 get Symbol.prototype.description

`Symbol.prototype.description` is an [accessor property](#) whose set accessor function is `undefined`. Its get accessor function performs the following steps when called:

1. Let `s` be the `this` value.
2. Let `sym` be ? `thisSymbolValue(s)`.
3. Return `sym`.[[Description]].

### 20.4.3.3 Symbol.prototype.toString ( )

This method performs the following steps when called:

1. Let `sym` be ? `thisSymbolValue(this value)`.
2. Return `SymbolDescriptiveString(sym)`.

#### 20.4.3.3.1 SymbolDescriptiveString ( *sym* )

The abstract operation `SymbolDescriptiveString` takes argument `sym` (a Symbol) and returns a String. It performs the following steps when called:

1. Let `desc` be `sym`'s [[Description]] value.
2. If `desc` is `undefined`, set `desc` to the empty String.
3. **Assert:** `desc` is a String.
4. Return the [string-concatenation](#) of `"Symbol(", desc, and "`".

### 20.4.3.4 Symbol.prototype.valueOf ( )

This method performs the following steps when called:

1. Return ? `thisSymbolValue(this value)`.

### 20.4.3.5 Symbol.prototype [ @@toPrimitive ] ( *hint* )

This method is called by ECMAScript language operators to convert a Symbol object to a primitive value.

It performs the following steps when called:

1. Return ? `thisSymbolValue(this value)`.

**NOTE** The argument is ignored.

This property has the attributes { [[Writable]]: **false**, [[Enumerable]]: **false**, [[Configurable]]: **true** }.

The value of the `"name"` property of this method is `"[Symbol.toPrimitive]"`.

### 20.4.3.6 Symbol.prototype [ @@toStringTag ]

The initial value of the @@toStringTag property is the String value "Symbol".

This property has the attributes { [[Writable]]: **false**, [[Enumerable]]: **false**, [[Configurable]]: **true** }.

### 20.4.4 Properties of Symbol Instances

Symbol instances are [ordinary objects](#) that inherit properties from the [Symbol prototype object](#). Symbol instances have a [[SymbolData]] internal slot. The [[SymbolData]] internal slot is the Symbol value represented by this Symbol object.

### 20.4.5 Abstract Operations for Symbols

#### 20.4.5.1 KeyForSymbol ( *sym* )

The abstract operation KeyForSymbol takes argument *sym* (a Symbol) and returns a String or **undefined**. If *sym* is in the GlobalSymbolRegistry (see [20.4.2.2](#)) the String used to register *sym* will be returned. It performs the following steps when called:

1. For each element *e* of the GlobalSymbolRegistry List, do
  - a. If SameValue(*e*.[[Symbol]], *sym*) is **true**, return *e*.[[Key]].
2. **Assert**: GlobalSymbolRegistry does not currently contain an entry for *sym*.
3. Return **undefined**.

## 20.5 Error Objects

Instances of Error objects are thrown as exceptions when runtime errors occur. The Error objects may also serve as base objects for user-defined exception classes.

When an ECMAScript implementation detects a runtime error, it throws a new instance of one of the [NativeError](#) objects defined in [20.5.5](#) or a new instance of AggregateError object defined in [20.5.7](#). Each of these objects has the structure described below, differing only in the name used as the [constructor](#) name instead of [NativeError](#), in the "name" property of the prototype object, in the [implementation-defined "message"](#) property of the prototype object, and in the presence of the [%AggregateError%](#)-specific "errors" property.

### 20.5.1 The Error Constructor

The Error [constructor](#):

- is [%Error%](#).
- is the initial value of the "Error" property of the [global object](#).
- creates and initializes a new Error object when called as a function rather than as a [constructor](#). Thus the function call **Error(...)** is equivalent to the object creation expression **new Error(...)** with the same arguments.
- may be used as the value of an **extends** clause of a class definition. Subclass [constructors](#) that intend to inherit the specified Error behaviour must include a **super** call to the Error [constructor](#) to create and initialize subclass instances with an [[ErrorData]] internal slot.

### 20.5.1.1 Error ( *message* [ , *options* ] )

This function performs the following steps when called:

1. If *NewTarget* is **undefined**, let *newTarget* be the [active function object](#); else let *newTarget* be *NewTarget*.
2. Let *O* be ? [OrdinaryCreateFromConstructor](#)(*newTarget*, "%Error.prototype%", « [[ErrorData]] »).
3. If *message* is not **undefined**, then
  - a. Let *msg* be ? [ToString](#)(*message*).
  - b. Perform [CreateNonEnumerableDataPropertyOrThrow](#)(*O*, "message", *msg*).
4. Perform ? [InstallErrorCause](#)(*O*, *options*).
5. Return *O*.

## 20.5.2 Properties of the Error Constructor

The Error [constructor](#):

- has a [[Prototype]] internal slot whose value is %Function.prototype%.
- has the following properties:

### 20.5.2.1 Error.prototype

The initial value of `Error.prototype` is the [Error prototype object](#).

This property has the attributes { [[Writable]]: **false**, [[Enumerable]]: **false**, [[Configurable]]: **false** }.

## 20.5.3 Properties of the Error Prototype Object

The *Error prototype object*:

- is %Error.prototype%.
- is an [ordinary object](#).
- is not an Error instance and does not have an [[ErrorData]] internal slot.
- has a [[Prototype]] internal slot whose value is %Object.prototype%.

### 20.5.3.1 Error.prototype.constructor

The initial value of `Error.prototype.constructor` is %Error%.

### 20.5.3.2 Error.prototype.message

The initial value of `Error.prototype.message` is the empty String.

### 20.5.3.3 Error.prototype.name

The initial value of `Error.prototype.name` is "Error".

### 20.5.3.4 Error.prototype.toString ( )

This method performs the following steps when called:

1. Let *O* be the **this** value.
2. If *O* is not an Object, throw a **TypeError** exception.
3. Let *name* be ? *Get*(*O*, "name").
4. If *name* is **undefined**, set *name* to "Error"; otherwise set *name* to ? *ToString*(*name*).
5. Let *msg* be ? *Get*(*O*, "message").
6. If *msg* is **undefined**, set *msg* to the empty String; otherwise set *msg* to ? *ToString*(*msg*).
7. If *name* is the empty String, return *msg*.
8. If *msg* is the empty String, return *name*.
9. Return the string-concatenation of *name*, the code unit 0x003A (COLON), the code unit 0x0020 (SPACE), and *msg*.

## 20.5.4 Properties of Error Instances

Error instances are [ordinary objects](#) that inherit properties from the [Error prototype object](#) and have an `[[ErrorData]]` internal slot whose value is **undefined**. The only specified uses of `[[ErrorData]]` is to identify Error, AggregateError, and [NativeError](#) instances as Error objects within `Object.prototype.toString`.

## 20.5.5 Native Error Types Used in This Standard

A new instance of one of the [NativeError](#) objects below or of the AggregateError object is thrown when a runtime error is detected. All [NativeError](#) objects share the same structure, as described in [20.5.6](#).

### 20.5.5.1 EvalError

The EvalError [constructor](#) is `%EvalError%`.

This exception is not currently used within this specification. This object remains for compatibility with previous editions of this specification.

### 20.5.5.2 RangeError

The RangeError [constructor](#) is `%RangeError%`.

Indicates a value that is not in the set or range of allowable values.

### 20.5.5.3 ReferenceError

The ReferenceError [constructor](#) is `%ReferenceError%`.

Indicate that an invalid reference has been detected.

### 20.5.5.4 SyntaxError

The SyntaxError [constructor](#) is `%SyntaxError%`.

Indicates that a parsing error has occurred.

### 20.5.5.5 TypeError

The TypeError [constructor](#) is `%TypeError%`.

`TypeError` is used to indicate an unsuccessful operation when none of the other *NativeError* objects are an appropriate indication of the failure cause.

### 20.5.5.6 `URIError`

The `URIError` constructor is `%URIError%`.

Indicates that one of the global URI handling functions was used in a way that is incompatible with its definition.

## 20.5.6 *NativeError* Object Structure

When an ECMAScript implementation detects a runtime error, it throws a new instance of one of the *NativeError* objects defined in 20.5.5. Each of these objects has the structure described below, differing only in the name used as the constructor name instead of *NativeError*, in the "name" property of the prototype object, and in the implementation-defined "message" property of the prototype object.

For each error object, references to *NativeError* in the definition should be replaced with the appropriate error object name from 20.5.5.

### 20.5.6.1 The *NativeError* Constructors

Each *NativeError* constructor:

- creates and initializes a new *NativeError* object when called as a function rather than as a constructor. A call of the object as a function is equivalent to calling it as a constructor with the same arguments. Thus the function call `NativeError(...)` is equivalent to the object creation expression `new NativeError(...)` with the same arguments.
- may be used as the value of an **extends** clause of a class definition. Subclass constructors that intend to inherit the specified *NativeError* behaviour must include a **super** call to the *NativeError* constructor to create and initialize subclass instances with an `[[ErrorData]]` internal slot.

#### 20.5.6.1.1 *NativeError* ( *message* [ , *options* ] )

Each *NativeError* function performs the following steps when called:

1. If `NewTarget` is **undefined**, let *newTarget* be the active function object; else let *newTarget* be `NewTarget`.
2. Let *O* be ? `OrdinaryCreateFromConstructor(newTarget, "%NativeError.prototype%", « [[ErrorData]] »)`.
3. If *message* is not **undefined**, then
  - a. Let *msg* be ? `Tostring(message)`.
  - b. Perform `CreateNonEnumerableDataPropertyOrThrow(O, "message", msg)`.
4. Perform ? `InstallErrorCause(O, options)`.
5. Return *O*.

The actual value of the string passed in step 2 is either `"%EvalError.prototype%"`, `"%RangeError.prototype%"`, `"%ReferenceError.prototype%"`, `"%SyntaxError.prototype%"`, `"%TypeError.prototype%"`, or `"%URIError.prototype%"` corresponding to which *NativeError* constructor is being defined.

### 20.5.6.2 Properties of the *NativeError* Constructors

Each *NativeError* constructor:

- has a `[[Prototype]]` internal slot whose value is `%Error%`.
- has a **"name"** property whose value is the String value **"NativeError"**.
- has the following properties:

#### 20.5.6.2.1 `NativeError.prototype`

The initial value of `NativeError.prototype` is a `NativeError` prototype object (20.5.6.3). Each `NativeError` constructor has a distinct prototype object.

This property has the attributes { `[[Writable]]`: **false**, `[[Enumerable]]`: **false**, `[[Configurable]]`: **false** }.

### 20.5.6.3 Properties of the `NativeError` Prototype Objects

Each `NativeError` prototype object:

- is an **ordinary object**.
- is not an Error instance and does not have an `[[ErrorData]]` internal slot.
- has a `[[Prototype]]` internal slot whose value is `%Error.prototype%`.

#### 20.5.6.3.1 `NativeError.prototype.constructor`

The initial value of the **"constructor"** property of the prototype for a given `NativeError` constructor is the corresponding intrinsic object `%NativeError%` (20.5.6.1).

#### 20.5.6.3.2 `NativeError.prototype.message`

The initial value of the **"message"** property of the prototype for a given `NativeError` constructor is the empty String.

#### 20.5.6.3.3 `NativeError.prototype.name`

The initial value of the **"name"** property of the prototype for a given `NativeError` constructor is the String value consisting of the name of the constructor (the name used instead of `NativeError`).

### 20.5.6.4 Properties of `NativeError` Instances

`NativeError` instances are **ordinary objects** that inherit properties from their `NativeError` prototype object and have an `[[ErrorData]]` internal slot whose value is **undefined**. The only specified use of `[[ErrorData]]` is by `Object.prototype.toString` (20.1.3.6) to identify Error, AggregateError, or `NativeError` instances.

## 20.5.7 AggregateError Objects

### 20.5.7.1 The AggregateError Constructor

The AggregateError constructor:

- is `%AggregateError%`.
- is the initial value of the **"AggregateError"** property of the **global object**.
- creates and initializes a new AggregateError object when called as a function rather than as a constructor. Thus the function call `AggregateError(...)` is equivalent to the object creation expression `new AggregateError(...)` with the same arguments.
- may be used as the value of an **extends** clause of a class definition. Subclass constructors that intend to inherit the specified AggregateError behaviour must include a **super** call to the AggregateError



`constructor` to create and initialize subclass instances with an `[[ErrorData]]` internal slot.

#### 20.5.7.1.1 AggregateError ( *errors*, *message* [ , *options* ] )

This function performs the following steps when called:

1. If `NewTarget` is **undefined**, let *newTarget* be the `active function object`; else let *newTarget* be `NewTarget`.
2. Let *O* be ? `OrdinaryCreateFromConstructor(newTarget, "%AggregateError.prototype%", « [[ErrorData]] »)`.
3. If *message* is not **undefined**, then
  - a. Let *msg* be ? `ToString(message)`.
  - b. Perform `CreateNonEnumerableDataPropertyOrThrow(O, "message", msg)`.
4. Perform ? `InstallErrorCause(O, options)`.
5. Let *errorsList* be ? `IteratorToList(? GetIterator(errors, sync))`.
6. Perform ! `DefinePropertyOrThrow(O, "errors", PropertyDescriptor { [[Configurable]]: true, [[Enumerable]]: false, [[Writable]]: true, [[Value]]: CreateArrayFromList(errorsList) }`).
7. Return *O*.

#### 20.5.7.2 Properties of the AggregateError Constructor

The `AggregateError` `constructor`:

- has a `[[Prototype]]` internal slot whose value is `%Error%`.
- has the following properties:

##### 20.5.7.2.1 AggregateError.prototype

The initial value of `AggregateError.prototype` is `%AggregateError.prototype%`.

This property has the attributes { `[[Writable]]: false`, `[[Enumerable]]: false`, `[[Configurable]]: false` }.

#### 20.5.7.3 Properties of the AggregateError Prototype Object

The `AggregateError` `prototype object`:

- is `%AggregateError.prototype%`.
- is an `ordinary object`.
- is not an `Error` instance or an `AggregateError` instance and does not have an `[[ErrorData]]` internal slot.
- has a `[[Prototype]]` internal slot whose value is `%Error.prototype%`.

##### 20.5.7.3.1 AggregateError.prototype.constructor

The initial value of `AggregateError.prototype.constructor` is `%AggregateError%`.

##### 20.5.7.3.2 AggregateError.prototype.message

The initial value of `AggregateError.prototype.message` is the empty String.

##### 20.5.7.3.3 AggregateError.prototype.name

The initial value of `AggregateError.prototype.name` is `"AggregateError"`.

#### 20.5.7.4 Properties of AggregateError Instances

AggregateError instances are [ordinary objects](#) that inherit properties from their [AggregateError prototype object](#) and have an `[[ErrorData]]` internal slot whose value is **undefined**. The only specified use of `[[ErrorData]]` is by `Object.prototype.toString` (20.1.3.6) to identify Error, AggregateError, or [NativeError](#) instances.

#### 20.5.8 Abstract Operations for Error Objects

##### 20.5.8.1 InstallErrorCause ( *O*, *options* )

The abstract operation InstallErrorCause takes arguments *O* (an Object) and *options* (an [ECMAScript language value](#)) and returns either a [normal completion containing unused](#) or a [throw completion](#). It is used to create a **"cause"** property on *O* when a **"cause"** property is present on *options*. It performs the following steps when called:

1. If *options* is an Object and `? HasProperty(options, "cause")` is **true**, then
  - a. Let *cause* be `? Get(options, "cause")`.
  - b. Perform `CreateNonEnumerableDataPropertyOrThrow(O, "cause", cause)`.
2. Return unused.

## 21 Numbers and Dates

### 21.1 Number Objects

#### 21.1.1 The Number Constructor

The Number [constructor](#):

- is `%Number%`.
- is the initial value of the **"Number"** property of the [global object](#).
- creates and initializes a new Number object when called as a [constructor](#).
- performs a type conversion when called as a function rather than as a [constructor](#).
- may be used as the value of an **extends** clause of a class definition. Subclass [constructors](#) that intend to inherit the specified Number behaviour must include a **super** call to the Number [constructor](#) to create and initialize the subclass instance with a `[[NumberData]]` internal slot.

##### 21.1.1.1 Number ( *value* )

This function performs the following steps when called:

1. If *value* is present, then
  - a. Let *prim* be `? ToNumeric(value)`.
  - b. If *prim* is a BigInt, let *n* be  $\mathbb{F}(\mathbb{R}(\textit{prim}))$ .
  - c. Otherwise, let *n* be *prim*.
2. Else,
  - a. Let *n* be  $+0_{\mathbb{F}}$ .
3. If `NewTarget` is **undefined**, return *n*.

4. Let  $O$  be ? `OrdinaryCreateFromConstructor`(`NewTarget`, "%Number.prototype%", «  
[[NumberData]] »).
5. Set  $O$ .[[NumberData]] to  $n$ .
6. Return  $O$ .

## 21.1.2 Properties of the Number Constructor

The Number `constructor`:

- has a [[Prototype]] internal slot whose value is %Function.prototype%.
- has the following properties:

### 21.1.2.1 Number.EPSILON

The value of `Number.EPSILON` is the `Number value for` the magnitude of the difference between 1 and the smallest value greater than 1 that is representable as a Number value, which is approximately  $2.2204460492503130808472633361816 \times 10^{-16}$ .

This property has the attributes { [[Writable]]: **false**, [[Enumerable]]: **false**, [[Configurable]]: **false** }.

### 21.1.2.2 Number.isFinite ( *number* )

This function performs the following steps when called:

1. If *number* is not a Number, return **false**.
2. If *number* is not finite, return **false**.
3. Otherwise, return **true**.

### 21.1.2.3 Number.isInteger ( *number* )

This function performs the following steps when called:

1. Return `isIntegralNumber`(*number*).

### 21.1.2.4 Number.isNaN ( *number* )

This function performs the following steps when called:

1. If *number* is not a Number, return **false**.
2. If *number* is NaN, return **true**.
3. Otherwise, return **false**.

**NOTE** This function differs from the global `isNaN` function (19.2.3) in that it does not convert its argument to a Number before determining whether it is NaN.

### 21.1.2.5 Number.isSafeInteger ( *number* )

**NOTE** An integer  $n$  is considered "safe" if and only if the `Number value for`  $n$  is not the `Number value for` any other integer.

This function performs the following steps when called:

1. If `IsIntegralNumber(number)` is **true**, then
  - a. If  $\text{abs}(\mathbb{R}(\textit{number})) \leq 2^{53} - 1$ , return **true**.
2. Return **false**.

### 21.1.2.6 Number.MAX\_SAFE\_INTEGER

**NOTE** Due to rounding behaviour necessitated by precision limitations of [IEEE 754-2019](#), the **Number value** for every **integer** greater than `Number.MAX_SAFE_INTEGER` is shared with at least one other **integer**. Such large-magnitude **integers** are therefore not **safe**, and are not guaranteed to be exactly representable as **Number** values or even to be distinguishable from each other. For example, both `9007199254740992` and `9007199254740993` evaluate to the **Number** value `9007199254740992`.

The value of `Number.MAX_SAFE_INTEGER` is `9007199254740991` ( $\mathbb{F}(2^{53} - 1)$ ).

This property has the attributes { `[[Writable]]: false`, `[[Enumerable]]: false`, `[[Configurable]]: false` }.

### 21.1.2.7 Number.MAX\_VALUE

The value of `Number.MAX_VALUE` is the largest positive **finite** value of the **Number** type, which is approximately  $1.7976931348623157 \times 10^{308}$ .

This property has the attributes { `[[Writable]]: false`, `[[Enumerable]]: false`, `[[Configurable]]: false` }.

### 21.1.2.8 Number.MIN\_SAFE\_INTEGER

**NOTE** Due to rounding behaviour necessitated by precision limitations of [IEEE 754-2019](#), the **Number value** for every **integer** less than `Number.MIN_SAFE_INTEGER` is shared with at least one other **integer**. Such large-magnitude **integers** are therefore not **safe**, and are not guaranteed to be exactly representable as **Number** values or even to be distinguishable from each other. For example, both `-9007199254740992` and `-9007199254740993` evaluate to the **Number** value `-9007199254740992`.

The value of `Number.MIN_SAFE_INTEGER` is `-9007199254740991` ( $\mathbb{F}(-(2^{53} - 1))$ ).

This property has the attributes { `[[Writable]]: false`, `[[Enumerable]]: false`, `[[Configurable]]: false` }.

### 21.1.2.9 Number.MIN\_VALUE

The value of `Number.MIN_VALUE` is the smallest positive value of the **Number** type, which is approximately  $5 \times 10^{-324}$ .

In the [IEEE 754-2019](#) double precision binary representation, the smallest possible value is a denormalized number. If an implementation does not support denormalized values, the value of `Number.MIN_VALUE` must be the smallest non-zero positive value that can actually be represented by the implementation.

This property has the attributes { `[[Writable]]: false`, `[[Enumerable]]: false`, `[[Configurable]]: false` }.

### 21.1.2.10 Number.NaN

The value of `Number.NaN` is `NaN`.

This property has the attributes { `[[Writable]]`: **false**, `[[Enumerable]]`: **false**, `[[Configurable]]`: **false** }.

### 21.1.2.11 Number.NEGATIVE\_INFINITY

The value of `Number.NEGATIVE_INFINITY` is  $-\infty_{\mathbb{F}}$ .

This property has the attributes { `[[Writable]]`: **false**, `[[Enumerable]]`: **false**, `[[Configurable]]`: **false** }.

### 21.1.2.12 Number.parseFloat ( *string* )

The initial value of the `"parseFloat"` property is `%parseFloat%`.

### 21.1.2.13 Number.parseInt ( *string, radix* )

The initial value of the `"parseInt"` property is `%parseInt%`.

### 21.1.2.14 Number.POSITIVE\_INFINITY

The value of `Number.POSITIVE_INFINITY` is  $+\infty_{\mathbb{F}}$ .

This property has the attributes { `[[Writable]]`: **false**, `[[Enumerable]]`: **false**, `[[Configurable]]`: **false** }.

### 21.1.2.15 Number.prototype

The initial value of `Number.prototype` is the [Number prototype object](#).

This property has the attributes { `[[Writable]]`: **false**, `[[Enumerable]]`: **false**, `[[Configurable]]`: **false** }.

## 21.1.3 Properties of the Number Prototype Object

The *Number prototype object*:

- is `%Number.prototype%`.
- is an [ordinary object](#).
- is itself a Number object; it has a `[[NumberData]]` internal slot with the value  $+0_{\mathbb{F}}$ .
- has a `[[Prototype]]` internal slot whose value is `%Object.prototype%`.

Unless explicitly stated otherwise, the methods of the Number prototype object defined below are not generic and the **this** value passed to them must be either a Number value or an object that has a `[[NumberData]]` internal slot that has been initialized to a Number value.

The abstract operation *thisNumberValue* takes argument *value*. It performs the following steps when called:

1. If *value* is a Number, return *value*.
2. If *value* is an Object and *value* has a `[[NumberData]]` internal slot, then
  - a. Let *n* be *value*.`[[NumberData]]`.
  - b. Assert: *n* is a Number.

- c. Return  $n$ .
3. Throw a **TypeError** exception.

The phrase “this Number value” within the specification of a method refers to the result returned by calling the abstract operation `thisNumberValue` with the **this** value of the method invocation passed as the argument.

### 21.1.3.1 `Number.prototype.constructor`

The initial value of `Number.prototype.constructor` is `%Number%`.

### 21.1.3.2 `Number.prototype.toExponential` ( *`fractionDigits`* )

This method returns a String containing this Number value represented in decimal exponential notation with one digit before the significand's decimal point and *`fractionDigits`* digits after the significand's decimal point. If *`fractionDigits`* is **undefined**, it includes as many significand digits as necessary to uniquely specify the Number (just like in `ToString` except that in this case the Number is always output in exponential notation).

It performs the following steps when called:

1. Let  $x$  be ? `thisNumberValue`(**this** value).
2. Let  $f$  be ? `ToIntegerOrInfinity`(*`fractionDigits`*).
3. **Assert**: If *`fractionDigits`* is **undefined**, then  $f$  is 0.
4. If  $x$  is not **finite**, return `Number::toString`( $x$ , 10).
5. If  $f < 0$  or  $f > 100$ , throw a **RangeError** exception.
6. Set  $x$  to  $\mathbb{R}(x)$ .
7. Let  $s$  be the empty String.
8. If  $x < 0$ , then
  - a. Set  $s$  to `"-"`.
  - b. Set  $x$  to  $-x$ .
9. If  $x = 0$ , then
  - a. Let  $m$  be the String value consisting of  $f + 1$  occurrences of the code unit 0x0030 (DIGIT ZERO).
  - b. Let  $e$  be 0.
10. Else,
  - a. If *`fractionDigits`* is not **undefined**, then
    - i. Let  $e$  and  $n$  be **integers** such that  $10^f \leq n < 10^{f+1}$  and for which  $n \times 10^{e-f} - x$  is as close to zero as possible. If there are two such sets of  $e$  and  $n$ , pick the  $e$  and  $n$  for which  $n \times 10^{e-f}$  is larger.
    - b. Else,
      - i. Let  $e$ ,  $n$ , and  $f$  be **integers** such that  $f \geq 0$ ,  $10^f \leq n < 10^{f+1}$ ,  $\mathbb{F}(n \times 10^{e-f})$  is  $\mathbb{F}(x)$ , and  $f$  is as small as possible. Note that the decimal representation of  $n$  has  $f + 1$  digits,  $n$  is not divisible by 10, and the least significant digit of  $n$  is not necessarily uniquely determined by these criteria.
      - c. Let  $m$  be the String value consisting of the digits of the decimal representation of  $n$  (in order, with no leading zeroes).
11. If  $f \neq 0$ , then
  - a. Let  $a$  be the first code unit of  $m$ .
  - b. Let  $b$  be the other  $f$  code units of  $m$ .
  - c. Set  $m$  to the **string-concatenation** of  $a$ , `"."`, and  $b$ .
12. If  $e = 0$ , then
  - a. Let  $c$  be `"+"`.

- b. Let  $d$  be "0".
- 13. Else,
  - a. If  $e > 0$ , let  $c$  be "+".
  - b. Else,
    - i. Assert:  $e < 0$ .
    - ii. Let  $c$  be "-".
    - iii. Set  $e$  to  $-e$ .
  - c. Let  $d$  be the String value consisting of the digits of the decimal representation of  $e$  (in order, with no leading zeroes).
- 14. Set  $m$  to the string-concatenation of  $m$ , "e",  $c$ , and  $d$ .
- 15. Return the string-concatenation of  $s$  and  $m$ .

NOTE For implementations that provide more accurate conversions than required by the rules above, it is recommended that the following alternative version of step 10.b.i be used as a guideline:

- i. Let  $e$ ,  $n$ , and  $f$  be integers such that  $f \geq 0$ ,  $10^f \leq n < 10^{f+1}$ ,  $\mathbb{F}(n \times 10^{e-f})$  is  $\mathbb{F}(x)$ , and  $f$  is as small as possible. If there are multiple possibilities for  $n$ , choose the value of  $n$  for which  $\mathbb{F}(n \times 10^{e-f})$  is closest in value to  $\mathbb{F}(x)$ . If there are two such possible values of  $n$ , choose the one that is even.

### 21.1.3.3 Number.prototype.toFixed ( *fractionDigits* )

NOTE 1 This method returns a String containing this Number value represented in decimal fixed-point notation with *fractionDigits* digits after the decimal point. If *fractionDigits* is **undefined**, 0 is assumed.

It performs the following steps when called:

1. Let  $x$  be ? **thisNumberValue**(**this** value).
2. Let  $f$  be ? **ToIntegerOrInfinity**(*fractionDigits*).
3. Assert: If *fractionDigits* is **undefined**, then  $f$  is 0.
4. If  $f$  is not **finite**, throw a **RangeError** exception.
5. If  $f < 0$  or  $f > 100$ , throw a **RangeError** exception.
6. If  $x$  is not **finite**, return **Number::toString**( $x$ , 10).
7. Set  $x$  to  $\mathbb{R}(x)$ .
8. Let  $s$  be the empty String.
9. If  $x < 0$ , then
  - a. Set  $s$  to "-".
  - b. Set  $x$  to  $-x$ .
10. If  $x \geq 10^{21}$ , then
  - a. Let  $m$  be ! **ToString**( $\mathbb{F}(x)$ ).
11. Else,
  - a. Let  $n$  be an integer for which  $n / 10^f - x$  is as close to zero as possible. If there are two such  $n$ , pick the larger  $n$ .
  - b. If  $n = 0$ , let  $m$  be "0". Otherwise, let  $m$  be the String value consisting of the digits of the decimal representation of  $n$  (in order, with no leading zeroes).
  - c. If  $f \neq 0$ , then
    - i. Let  $k$  be the length of  $m$ .
    - ii. If  $k \leq f$ , then

1. Let *z* be the String value consisting of *f* + 1 - *k* occurrences of the code unit 0x0030 (DIGIT ZERO).
  2. Set *m* to the [string-concatenation](#) of *z* and *m*.
  3. Set *k* to *f* + 1.
  - iii. Let *a* be the first *k* - *f* code units of *m*.
  - iv. Let *b* be the other *f* code units of *m*.
  - v. Set *m* to the [string-concatenation](#) of *a*, ".", and *b*.
12. Return the [string-concatenation](#) of *s* and *m*.

NOTE 2 The output of `toFixed` may be more precise than `toString` for some values because `toString` only prints enough significant digits to distinguish the number from adjacent Number values. For example,

```
(10000000000000000128).toString() returns "1000000000000000100", while
(10000000000000000128).toFixed(0) returns "1000000000000000128".
```

#### 21.1.3.4 Number.prototype.toLocaleString ( [ *reserved1* [ , *reserved2* ] ] )

An ECMAScript implementation that includes the ECMA-402 Internationalization API must implement this method as specified in the ECMA-402 specification. If an ECMAScript implementation does not include the ECMA-402 API the following specification of this method is used:

This method produces a String value that represents this Number value formatted according to the conventions of the [host environment's](#) current locale. This method is [implementation-defined](#), and it is permissible, but not encouraged, for it to return the same thing as `toString`.

The meanings of the optional parameters to this method are defined in the ECMA-402 specification; implementations that do not include ECMA-402 support must not use those parameter positions for anything else.

#### 21.1.3.5 Number.prototype.toPrecision ( *precision* )

This method returns a String containing this Number value represented either in decimal exponential notation with one digit before the significand's decimal point and *precision* - 1 digits after the significand's decimal point or in decimal fixed notation with *precision* significant digits. If *precision* is `undefined`, it calls `ToString` instead.

It performs the following steps when called:

1. Let *x* be ? `thisNumberValue(this value)`.
2. If *precision* is `undefined`, return ! `Tostring(x)`.
3. Let *p* be ? `ToIntegerOrInfinity(precision)`.
4. If *x* is not `finite`, return `Number::toString(x, 10)`.
5. If *p* < 1 or *p* > 100, throw a `RangeError` exception.
6. Set *x* to  $\mathbb{R}(x)$ .
7. Let *s* be the empty String.
8. If *x* < 0, then
  - a. Set *s* to the code unit 0x002D (HYPHEN-MINUS).
  - b. Set *x* to -*x*.
9. If *x* = 0, then
  - a. Let *m* be the String value consisting of *p* occurrences of the code unit 0x0030 (DIGIT ZERO).
  - b. Let *e* be 0.
10. Else,



- a. Let  $e$  and  $n$  be integers such that  $10^{p-1} \leq n < 10^p$  and for which  $n \times 10^{e-p+1} - x$  is as close to zero as possible. If there are two such sets of  $e$  and  $n$ , pick the  $e$  and  $n$  for which  $n \times 10^{e-p+1}$  is larger.
- b. Let  $m$  be the String value consisting of the digits of the decimal representation of  $n$  (in order, with no leading zeroes).
- c. If  $e < -6$  or  $e \geq p$ , then
  - i. Assert:  $e \neq 0$ .
  - ii. If  $p \neq 1$ , then
    1. Let  $a$  be the first code unit of  $m$ .
    2. Let  $b$  be the other  $p - 1$  code units of  $m$ .
    3. Set  $m$  to the string-concatenation of  $a$ , ".", and  $b$ .
  - iii. If  $e > 0$ , then
    1. Let  $c$  be the code unit 0x002B (PLUS SIGN).
  - iv. Else,
    1. Assert:  $e < 0$ .
    2. Let  $c$  be the code unit 0x002D (HYPHEN-MINUS).
    3. Set  $e$  to  $-e$ .
  - v. Let  $d$  be the String value consisting of the digits of the decimal representation of  $e$  (in order, with no leading zeroes).
  - vi. Return the string-concatenation of  $s$ ,  $m$ , the code unit 0x0065 (LATIN SMALL LETTER E),  $c$ , and  $d$ .
11. If  $e = p - 1$ , return the string-concatenation of  $s$  and  $m$ .
12. If  $e \geq 0$ , then
  - a. Set  $m$  to the string-concatenation of the first  $e + 1$  code units of  $m$ , the code unit 0x002E (FULL STOP), and the remaining  $p - (e + 1)$  code units of  $m$ .
13. Else,
  - a. Set  $m$  to the string-concatenation of the code unit 0x0030 (DIGIT ZERO), the code unit 0x002E (FULL STOP),  $-(e + 1)$  occurrences of the code unit 0x0030 (DIGIT ZERO), and the String  $m$ .
14. Return the string-concatenation of  $s$  and  $m$ .

### 21.1.3.6 Number.prototype.toString ( [ radix ] )

**NOTE** The optional *radix* should be an integral Number value in the inclusive interval from 2<sub>F</sub> to 36<sub>F</sub>. If *radix* is undefined then 10<sub>F</sub> is used as the value of *radix*.

This method performs the following steps when called:

1. Let  $x$  be ? thisNumberValue(this value).
2. If *radix* is undefined, let *radixMV* be 10.
3. Else, let *radixMV* be ? ToIntegerOrInfinity(*radix*).
4. If *radixMV* is not in the inclusive interval from 2 to 36, throw a RangeError exception.
5. Return Number::toString( $x$ , *radixMV*).

This method is not generic; it throws a TypeError exception if its **this** value is not a Number or a Number object. Therefore, it cannot be transferred to other kinds of objects for use as a method.

The "length" property of this method is 1<sub>F</sub>.

### 21.1.3.7 Number.prototype.valueOf ( )

1. Return ? [thisNumberValue](#)(this value).

## 21.1.4 Properties of Number Instances

Number instances are [ordinary objects](#) that inherit properties from the [Number prototype object](#). Number instances also have a [\[\[NumberData\]\]](#) internal slot. The [\[\[NumberData\]\]](#) internal slot is the Number value represented by this Number object.

## 21.2 BigInt Objects

### 21.2.1 The BigInt Constructor

The BigInt [constructor](#):

- is [%BigInt%](#).
- is the initial value of the **"BigInt"** property of the [global object](#).
- performs a type conversion when called as a function rather than as a [constructor](#).
- is not intended to be used with the **new** operator or to be subclassed. It may be used as the value of an **extends** clause of a class definition but a **super** call to the BigInt [constructor](#) will cause an exception.

#### 21.2.1.1 BigInt ( *value* )

This function performs the following steps when called:

1. If *NewTarget* is not **undefined**, throw a **TypeError** exception.
2. Let *prim* be ? [ToPrimitive](#)(*value*, number).
3. If *prim* is a Number, return ? [NumberToBigInt](#)(*prim*).
4. Otherwise, return ? [ToBigInt](#)(*prim*).

##### 21.2.1.1.1 NumberToBigInt ( *number* )

The abstract operation [NumberToBigInt](#) takes argument *number* (a Number) and returns either a [normal completion containing](#) a BigInt or a [throw completion](#). It performs the following steps when called:

1. If [IsIntegralNumber](#)(*number*) is **false**, throw a **RangeError** exception.
2. Return the BigInt value that represents  $\mathbb{R}$ (*number*).

### 21.2.2 Properties of the BigInt Constructor

The BigInt [constructor](#):

- has a [\[\[Prototype\]\]](#) internal slot whose value is [%Function.prototype%](#).
- has the following properties:

#### 21.2.2.1 BigInt.asIntN ( *bits*, *bigint* )

This function performs the following steps when called:

1. Set *bits* to ? [ToIndex](#)(*bits*).

2. Set *bigint* to ? `ToBigInt(bigint)`.
3. Let *mod* be  $\mathbb{R}(\textit{bigint})$  modulo  $2^{\textit{bits}}$ .
4. If  $\textit{mod} \geq 2^{\textit{bits} - 1}$ , return  $\mathbb{Z}(\textit{mod} - 2^{\textit{bits}})$ ; otherwise, return  $\mathbb{Z}(\textit{mod})$ .

### 21.2.2.2 BigInt.asUintN ( *bits*, *bigint* )

This function performs the following steps when called:

1. Set *bits* to ? `ToIndex(bits)`.
2. Set *bigint* to ? `ToBigInt(bigint)`.
3. Return the BigInt value that represents  $\mathbb{R}(\textit{bigint})$  modulo  $2^{\textit{bits}}$ .

### 21.2.2.3 BigInt.prototype

The initial value of `BigInt.prototype` is the `BigInt prototype object`.

This property has the attributes { `[[Writable]]`: **false**, `[[Enumerable]]`: **false**, `[[Configurable]]`: **false** }.

## 21.2.3 Properties of the BigInt Prototype Object

The *BigInt prototype object*:

- is `%BigInt.prototype%`.
- is an `ordinary object`.
- is **not** a `BigInt` object; it does not have a `[[BigIntData]]` internal slot.
- has a `[[Prototype]]` internal slot whose value is `%Object.prototype%`.

The abstract operation *thisBigIntValue* takes argument *value*. It performs the following steps when called:

1. If *value* is a `BigInt`, return *value*.
2. If *value* is an `Object` and *value* has a `[[BigIntData]]` internal slot, then
  - a. **Assert**: *value*.`[[BigIntData]]` is a `BigInt`.
  - b. Return *value*.`[[BigIntData]]`.
3. Throw a **TypeError** exception.

The phrase “this BigInt value” within the specification of a method refers to the result returned by calling the abstract operation *thisBigIntValue* with the **this** value of the method invocation passed as the argument.

### 21.2.3.1 BigInt.prototype.constructor

The initial value of `BigInt.prototype.constructor` is `%BigInt%`.

### 21.2.3.2 BigInt.prototype.toLocaleString ( [ *reserved1* [ , *reserved2* ] ] )

An ECMAScript implementation that includes the ECMA-402 Internationalization API must implement this method as specified in the ECMA-402 specification. If an ECMAScript implementation does not include the ECMA-402 API the following specification of this method is used:

This method produces a `String` value that represents this `BigInt` value formatted according to the conventions of the `host environment`'s current locale. This method is `implementation-defined`, and it is permissible, but not encouraged, for it to return the same thing as `toString`.

The meanings of the optional parameters to this method are defined in the ECMA-402 specification; implementations that do not include ECMA-402 support must not use those parameter positions for anything else.

### 21.2.3.3 BigInt.prototype.toString ( [ *radix* ] )

NOTE The optional *radix* should be an [integral Number](#) value in the [inclusive interval](#) from  $2_{\text{F}}$  to  $36_{\text{F}}$ . If *radix* is **undefined** then  $10_{\text{F}}$  is used as the value of *radix*.

This method performs the following steps when called:

1. Let *x* be ? [thisBigIntValue](#)(**this** value).
2. If *radix* is **undefined**, let *radixMV* be 10.
3. Else, let *radixMV* be ? [ToIntegerOrInfinity](#)(*radix*).
4. If *radixMV* is not in the [inclusive interval](#) from 2 to 36, throw a **RangeError** exception.
5. Return [BigInt::toString](#)(*x*, *radixMV*).

This method is not generic; it throws a **TypeError** exception if its **this** value is not a [BigInt](#) or a [BigInt](#) object. Therefore, it cannot be transferred to other kinds of objects for use as a method.

### 21.2.3.4 BigInt.prototype.valueOf ( )

1. Return ? [thisBigIntValue](#)(**this** value).

### 21.2.3.5 BigInt.prototype [ @@toStringTag ]

The initial value of the [@@toStringTag](#) property is the String value **"BigInt"**.

This property has the attributes { [\[\[Writable\]\]](#): **false**, [\[\[Enumerable\]\]](#): **false**, [\[\[Configurable\]\]](#): **true** }.

## 21.3 The Math Object

The Math object:

- is [%Math%](#).
- is the initial value of the **"Math"** property of the [global object](#).
- is an [ordinary object](#).
- has a [\[\[Prototype\]\]](#) internal slot whose value is [%Object.prototype%](#).
- is not a [function object](#).
- does not have a [\[\[Construct\]\]](#) internal method; it cannot be used as a [constructor](#) with the **new** operator.
- does not have a [\[\[Call\]\]](#) internal method; it cannot be invoked as a function.

NOTE In this specification, the phrase “the [Number value for \*x\*](#)” has a technical meaning defined in [6.1.6.1](#).

### 21.3.1 Value Properties of the Math Object

### 21.3.1.1 Math.E

The [Number value for e](#), the base of the natural logarithms, which is approximately 2.7182818284590452354.

This property has the attributes { `[[Writable]]: false`, `[[Enumerable]]: false`, `[[Configurable]]: false` }.

### 21.3.1.2 Math.LN10

The [Number value for](#) the natural logarithm of 10, which is approximately 2.302585092994046.

This property has the attributes { `[[Writable]]: false`, `[[Enumerable]]: false`, `[[Configurable]]: false` }.

### 21.3.1.3 Math.LN2

The [Number value for](#) the natural logarithm of 2, which is approximately 0.6931471805599453.

This property has the attributes { `[[Writable]]: false`, `[[Enumerable]]: false`, `[[Configurable]]: false` }.

### 21.3.1.4 Math.LOG10E

The [Number value for](#) the base-10 logarithm of [e](#), the base of the natural logarithms; this value is approximately 0.4342944819032518.

This property has the attributes { `[[Writable]]: false`, `[[Enumerable]]: false`, `[[Configurable]]: false` }.

**NOTE** The value of `Math.LOG10E` is approximately the reciprocal of the value of `Math.LN10`.

### 21.3.1.5 Math.LOG2E

The [Number value for](#) the base-2 logarithm of [e](#), the base of the natural logarithms; this value is approximately 1.4426950408889634.

This property has the attributes { `[[Writable]]: false`, `[[Enumerable]]: false`, `[[Configurable]]: false` }.

**NOTE** The value of `Math.LOG2E` is approximately the reciprocal of the value of `Math.LN2`.

### 21.3.1.6 Math.PI

The [Number value for](#)  $\pi$ , the ratio of the circumference of a circle to its diameter, which is approximately 3.1415926535897932.

This property has the attributes { `[[Writable]]: false`, `[[Enumerable]]: false`, `[[Configurable]]: false` }.

### 21.3.1.7 Math.SQRT1\_2

The [Number value for](#) the square root of  $\frac{1}{2}$ , which is approximately 0.7071067811865476.

This property has the attributes { `[[Writable]]: false`, `[[Enumerable]]: false`, `[[Configurable]]: false` }.

NOTE The value of `Math.SQRT1_2` is approximately the reciprocal of the value of `Math.SQRT2`.

### 21.3.1.8 Math.SQRT2

The [Number value](#) for the square root of 2, which is approximately 1.4142135623730951.

This property has the attributes { `[[Writable]]`: **false**, `[[Enumerable]]`: **false**, `[[Configurable]]`: **false** }.

### 21.3.1.9 Math [ @@toStringTag ]

The initial value of the `@@toStringTag` property is the String value **"Math"**.

This property has the attributes { `[[Writable]]`: **false**, `[[Enumerable]]`: **false**, `[[Configurable]]`: **true** }.

## 21.3.2 Function Properties of the Math Object

NOTE The behaviour of the functions `acos`, `acosh`, `asin`, `asinh`, `atan`, `atanh`, `atan2`, `cbt`, `cos`, `cosh`, `exp`, `expm1`, `hypot`, `log`, `log1p`, `log2`, `log10`, `pow`, `random`, `sin`, `sinh`, `sqr`, `tan`, and `tanh` is not precisely specified here except to require specific results for certain argument values that represent boundary cases of interest. For other argument values, these functions are intended to compute approximations to the results of familiar mathematical functions, but some latitude is allowed in the choice of approximation algorithms. The general intent is that an implementer should be able to use the same mathematical library for ECMAScript on a given hardware platform that is available to C programmers on that platform.

Although the choice of algorithms is left to the implementation, it is recommended (but not specified by this standard) that implementations use the approximation algorithms for [IEEE 754-2019](#) arithmetic contained in `fdlibm`, the freely distributable mathematical library from Sun Microsystems (<http://www.netlib.org/fdlibm>).

### 21.3.2.1 Math.abs ( x )

This function returns the absolute value of `x`; the result has the same magnitude as `x` but has positive sign.

It performs the following steps when called:

1. Let `n` be ? `ToNumber(x)`.
2. If `n` is **NaN**, return **NaN**.
3. If `n` is  $-0_{\mathbb{F}}$ , return  $+0_{\mathbb{F}}$ .
4. If `n` is  $-\infty_{\mathbb{F}}$ , return  $+\infty_{\mathbb{F}}$ .
5. If `n` <  $-0_{\mathbb{F}}$ , return  $-n$ .
6. Return `n`.

### 21.3.2.2 Math.acos ( x )

This function returns the inverse cosine of `x`. The result is expressed in radians and is in the [inclusive interval](#) from  $+0_{\mathbb{F}}$  to  $\mathbb{F}(\pi)$ .

It performs the following steps when called:

1. Let  $n$  be ? `ToNumber(x)`.
2. If  $n$  is **NaN**,  $n > 1_{\mathbb{F}}$  or  $n < -1_{\mathbb{F}}$ , return **NaN**.
3. If  $n$  is  $1_{\mathbb{F}}$ , return **+0<sub>F</sub>**.
4. Return an **implementation-approximated** Number value representing the result of the inverse cosine of  $\mathbb{R}(n)$ .

### 21.3.2.3 `Math.acosh ( x )`

This function returns the inverse hyperbolic cosine of  $x$ .

It performs the following steps when called:

1. Let  $n$  be ? `ToNumber(x)`.
2. If  $n$  is either **NaN** or **+∞<sub>F</sub>**, return  $n$ .
3. If  $n$  is  $1_{\mathbb{F}}$ , return **+0<sub>F</sub>**.
4. If  $n < 1_{\mathbb{F}}$ , return **NaN**.
5. Return an **implementation-approximated** Number value representing the result of the inverse hyperbolic cosine of  $\mathbb{R}(n)$ .

### 21.3.2.4 `Math.asin ( x )`

This function returns the inverse sine of  $x$ . The result is expressed in radians and is in the **inclusive interval** from  $\mathbb{F}(-\pi / 2)$  to  $\mathbb{F}(\pi / 2)$ .

It performs the following steps when called:

1. Let  $n$  be ? `ToNumber(x)`.
2. If  $n$  is one of **NaN**, **+0<sub>F</sub>** or **-0<sub>F</sub>**, return  $n$ .
3. If  $n > 1_{\mathbb{F}}$  or  $n < -1_{\mathbb{F}}$ , return **NaN**.
4. Return an **implementation-approximated** Number value representing the result of the inverse sine of  $\mathbb{R}(n)$ .

### 21.3.2.5 `Math.asinh ( x )`

This function returns the inverse hyperbolic sine of  $x$ .

It performs the following steps when called:

1. Let  $n$  be ? `ToNumber(x)`.
2. If  $n$  is not **finite** or  $n$  is either **+0<sub>F</sub>** or **-0<sub>F</sub>**, return  $n$ .
3. Return an **implementation-approximated** Number value representing the result of the inverse hyperbolic sine of  $\mathbb{R}(n)$ .

### 21.3.2.6 `Math.atan ( x )`

This function returns the inverse tangent of  $x$ . The result is expressed in radians and is in the **inclusive interval** from  $\mathbb{F}(-\pi / 2)$  to  $\mathbb{F}(\pi / 2)$ .

It performs the following steps when called:

1. Let  $n$  be ? `ToNumber(x)`.

2. If  $n$  is one of **NaN**,  $+0_{\mathbb{F}}$ , or  $-0_{\mathbb{F}}$ , return  $n$ .
3. If  $n$  is  $+\infty_{\mathbb{F}}$ , return an **implementation-approximated** Number value representing  $\pi / 2$ .
4. If  $n$  is  $-\infty_{\mathbb{F}}$ , return an **implementation-approximated** Number value representing  $-\pi / 2$ .
5. Return an **implementation-approximated** Number value representing the result of the inverse tangent of  $\mathbb{R}(n)$ .

### 21.3.2.7 Math.atanh ( $x$ )

This function returns the inverse hyperbolic tangent of  $x$ .

It performs the following steps when called:

1. Let  $n$  be ? **ToNumber**( $x$ ).
2. If  $n$  is one of **NaN**,  $+0_{\mathbb{F}}$ , or  $-0_{\mathbb{F}}$ , return  $n$ .
3. If  $n > 1_{\mathbb{F}}$  or  $n < -1_{\mathbb{F}}$ , return **NaN**.
4. If  $n$  is  $1_{\mathbb{F}}$ , return  $+\infty_{\mathbb{F}}$ .
5. If  $n$  is  $-1_{\mathbb{F}}$ , return  $-\infty_{\mathbb{F}}$ .
6. Return an **implementation-approximated** Number value representing the result of the inverse hyperbolic tangent of  $\mathbb{R}(n)$ .

### 21.3.2.8 Math.atan2 ( $y, x$ )

This function returns the inverse tangent of the quotient  $y / x$  of the arguments  $y$  and  $x$ , where the signs of  $y$  and  $x$  are used to determine the quadrant of the result. Note that it is intentional and traditional for the two-argument inverse tangent function that the argument named  $y$  be first and the argument named  $x$  be second. The result is expressed in radians and is in the **inclusive interval** from  $-\pi$  to  $+\pi$ .

It performs the following steps when called:

1. Let  $ny$  be ? **ToNumber**( $y$ ).
2. Let  $nx$  be ? **ToNumber**( $x$ ).
3. If  $ny$  is **NaN** or  $nx$  is **NaN**, return **NaN**.
4. If  $ny$  is  $+\infty_{\mathbb{F}}$ , then
  - a. If  $nx$  is  $+\infty_{\mathbb{F}}$ , return an **implementation-approximated** Number value representing  $\pi / 4$ .
  - b. If  $nx$  is  $-\infty_{\mathbb{F}}$ , return an **implementation-approximated** Number value representing  $3\pi / 4$ .
  - c. Return an **implementation-approximated** Number value representing  $\pi / 2$ .
5. If  $ny$  is  $-\infty_{\mathbb{F}}$ , then
  - a. If  $nx$  is  $+\infty_{\mathbb{F}}$ , return an **implementation-approximated** Number value representing  $-\pi / 4$ .
  - b. If  $nx$  is  $-\infty_{\mathbb{F}}$ , return an **implementation-approximated** Number value representing  $-3\pi / 4$ .
  - c. Return an **implementation-approximated** Number value representing  $-\pi / 2$ .
6. If  $ny$  is  $+0_{\mathbb{F}}$ , then
  - a. If  $nx > +0_{\mathbb{F}}$  or  $nx$  is  $+0_{\mathbb{F}}$ , return  $+0_{\mathbb{F}}$ .
  - b. Return an **implementation-approximated** Number value representing  $\pi$ .
7. If  $ny$  is  $-0_{\mathbb{F}}$ , then
  - a. If  $nx > +0_{\mathbb{F}}$  or  $nx$  is  $+0_{\mathbb{F}}$ , return  $-0_{\mathbb{F}}$ .
  - b. Return an **implementation-approximated** Number value representing  $-\pi$ .



8. Assert:  $ny$  is finite and is neither  $+0_{\mathbb{F}}$  nor  $-0_{\mathbb{F}}$ .
9. If  $ny > +0_{\mathbb{F}}$ , then
  - a. If  $nx$  is  $+\infty_{\mathbb{F}}$ , return  $+0_{\mathbb{F}}$ .
  - b. If  $nx$  is  $-\infty_{\mathbb{F}}$ , return an implementation-approximated Number value representing  $\pi$ .
  - c. If  $nx$  is either  $+0_{\mathbb{F}}$  or  $-0_{\mathbb{F}}$ , return an implementation-approximated Number value representing  $\pi / 2$ .
10. If  $ny < -0_{\mathbb{F}}$ , then
  - a. If  $nx$  is  $+\infty_{\mathbb{F}}$ , return  $-0_{\mathbb{F}}$ .
  - b. If  $nx$  is  $-\infty_{\mathbb{F}}$ , return an implementation-approximated Number value representing  $-\pi$ .
  - c. If  $nx$  is either  $+0_{\mathbb{F}}$  or  $-0_{\mathbb{F}}$ , return an implementation-approximated Number value representing  $-\pi / 2$ .
11. Assert:  $nx$  is finite and is neither  $+0_{\mathbb{F}}$  nor  $-0_{\mathbb{F}}$ .
12. Return an implementation-approximated Number value representing the result of the inverse tangent of the quotient  $\mathbb{R}(ny) / \mathbb{R}(nx)$ .

### 21.3.2.9 Math.cbrt ( $x$ )

This function returns the cube root of  $x$ .

It performs the following steps when called:

1. Let  $n$  be ? ToNumber( $x$ ).
2. If  $n$  is not finite or  $n$  is either  $+0_{\mathbb{F}}$  or  $-0_{\mathbb{F}}$ , return  $n$ .
3. Return an implementation-approximated Number value representing the result of the cube root of  $\mathbb{R}(n)$ .

### 21.3.2.10 Math.ceil ( $x$ )

This function returns the smallest (closest to  $-\infty$ ) integral Number value that is not less than  $x$ . If  $x$  is already an integral Number, the result is  $x$ .

It performs the following steps when called:

1. Let  $n$  be ? ToNumber( $x$ ).
2. If  $n$  is not finite or  $n$  is either  $+0_{\mathbb{F}}$  or  $-0_{\mathbb{F}}$ , return  $n$ .
3. If  $n < -0_{\mathbb{F}}$  and  $n > -1_{\mathbb{F}}$ , return  $-0_{\mathbb{F}}$ .
4. If  $n$  is an integral Number, return  $n$ .
5. Return the smallest (closest to  $-\infty$ ) integral Number value that is not less than  $n$ .

**NOTE** The value of `Math.ceil(x)` is the same as the value of `-Math.floor(-x)`.

### 21.3.2.11 Math.clz32 ( $x$ )

This function performs the following steps when called:

1. Let  $n$  be ? ToUint32( $x$ ).
2. Let  $p$  be the number of leading zero bits in the unsigned 32-bit binary representation of  $n$ .
3. Return  $\mathbb{F}(p)$ .

**NOTE** If  $n$  is either  $+0_{\mathbb{F}}$  or  $-0_{\mathbb{F}}$ , this method returns  $32_{\mathbb{F}}$ . If the most significant bit of the 32-bit binary encoding of  $n$  is 1, this method returns  $+0_{\mathbb{F}}$ .

### 21.3.2.12 **Math.cos** ( $x$ )

This function returns the cosine of  $x$ . The argument is expressed in radians.

It performs the following steps when called:

1. Let  $n$  be ? `ToNumber`( $x$ ).
2. If  $n$  is not `finite`, return `NaN`.
3. If  $n$  is either  $+0_{\mathbb{F}}$  or  $-0_{\mathbb{F}}$ , return  $1_{\mathbb{F}}$ .
4. Return an `implementation-approximated` Number value representing the result of the cosine of  $\mathbb{R}(n)$ .

### 21.3.2.13 **Math.cosh** ( $x$ )

This function returns the hyperbolic cosine of  $x$ .

It performs the following steps when called:

1. Let  $n$  be ? `ToNumber`( $x$ ).
2. If  $n$  is `NaN`, return `NaN`.
3. If  $n$  is either  $+\infty_{\mathbb{F}}$  or  $-\infty_{\mathbb{F}}$ , return  $+\infty_{\mathbb{F}}$ .
4. If  $n$  is either  $+0_{\mathbb{F}}$  or  $-0_{\mathbb{F}}$ , return  $1_{\mathbb{F}}$ .
5. Return an `implementation-approximated` Number value representing the result of the hyperbolic cosine of  $\mathbb{R}(n)$ .

**NOTE** The value of `Math.cosh(x)` is the same as the value of `(Math.exp(x) + Math.exp(-x)) / 2`.

### 21.3.2.14 **Math.exp** ( $x$ )

This function returns the exponential function of  $x$  ( $e$  raised to the power of  $x$ , where  $e$  is the base of the natural logarithms).

It performs the following steps when called:

1. Let  $n$  be ? `ToNumber`( $x$ ).
2. If  $n$  is either `NaN` or  $+\infty_{\mathbb{F}}$ , return  $n$ .
3. If  $n$  is either  $+0_{\mathbb{F}}$  or  $-0_{\mathbb{F}}$ , return  $1_{\mathbb{F}}$ .
4. If  $n$  is  $-\infty_{\mathbb{F}}$ , return  $+0_{\mathbb{F}}$ .
5. Return an `implementation-approximated` Number value representing the result of the exponential function of  $\mathbb{R}(n)$ .

### 21.3.2.15 **Math.expm1** ( $x$ )

This function returns the result of subtracting 1 from the exponential function of  $x$  ( $e$  raised to the power of  $x$ , where  $e$  is the base of the natural logarithms). The result is computed in a way that is accurate even when the value of  $x$  is close to 0.

It performs the following steps when called:

1. Let  $n$  be ? `ToNumber`( $x$ ).
2. If  $n$  is one of **NaN**,  $+0_{\mathbb{F}}$ ,  $-0_{\mathbb{F}}$ , or  $+\infty_{\mathbb{F}}$ , return  $n$ .
3. If  $n$  is  $-\infty_{\mathbb{F}}$ , return  $-1_{\mathbb{F}}$ .
4. Return an [implementation-approximated](#) Number value representing the result of subtracting 1 from the exponential function of  $\mathbb{R}(n)$ .

### 21.3.2.16 `Math.floor ( x )`

This function returns the greatest (closest to  $+\infty$ ) [integral Number](#) value that is not greater than  $x$ . If  $x$  is already an [integral Number](#), the result is  $x$ .

It performs the following steps when called:

1. Let  $n$  be ? `ToNumber`( $x$ ).
2. If  $n$  is not [finite](#) or  $n$  is either  $+0_{\mathbb{F}}$  or  $-0_{\mathbb{F}}$ , return  $n$ .
3. If  $n < 1_{\mathbb{F}}$  and  $n > +0_{\mathbb{F}}$ , return  $+0_{\mathbb{F}}$ .
4. If  $n$  is an [integral Number](#), return  $n$ .
5. Return the greatest (closest to  $+\infty$ ) [integral Number](#) value that is not greater than  $n$ .

**NOTE** The value of `Math.floor(x)` is the same as the value of `-Math.ceil(-x)`.

### 21.3.2.17 `Math.fround ( x )`

This function performs the following steps when called:

1. Let  $n$  be ? `ToNumber`( $x$ ).
2. If  $n$  is **NaN**, return **NaN**.
3. If  $n$  is one of  $+0_{\mathbb{F}}$ ,  $-0_{\mathbb{F}}$ ,  $+\infty_{\mathbb{F}}$ , or  $-\infty_{\mathbb{F}}$ , return  $n$ .
4. Let  $n32$  be the result of converting  $n$  to a value in [IEEE 754-2019](#) binary32 format using `roundTiesToEven` mode.
5. Let  $n64$  be the result of converting  $n32$  to a value in [IEEE 754-2019](#) binary64 format.
6. Return the ECMAScript Number value corresponding to  $n64$ .

### 21.3.2.18 `Math.hypot ( ...args )`

Given zero or more arguments, this function returns the square root of the sum of squares of its arguments.

It performs the following steps when called:

1. Let `coerced` be a new empty [List](#).
2. For each element `arg` of `args`, do
  - a. Let  $n$  be ? `ToNumber`(`arg`).
  - b. Append  $n$  to `coerced`.
3. For each element `number` of `coerced`, do
  - a. If `number` is either  $+\infty_{\mathbb{F}}$  or  $-\infty_{\mathbb{F}}$ , return  $+\infty_{\mathbb{F}}$ .
4. Let `onlyZero` be **true**.
5. For each element `number` of `coerced`, do

- a. If *number* is **NaN**, return **NaN**.
  - b. If *number* is neither **+0<sub>F</sub>** nor **-0<sub>F</sub>**, set *onlyZero* to **false**.
6. If *onlyZero* is **true**, return **+0<sub>F</sub>**.
  7. Return an **implementation-approximated** Number value representing the square root of the sum of squares of the **mathematical values** of the elements of *coerced*.

The **"length"** property of this function is **2<sub>F</sub>**.

**NOTE** Implementations should take care to avoid the loss of precision from overflows and underflows that are prone to occur in naive implementations when this function is called with two or more arguments.

### 21.3.2.19 Math.imul ( *x*, *y* )

This function performs the following steps when called:

1. Let *a* be  $\mathbb{R}(? \text{ToUint32}(x))$ .
2. Let *b* be  $\mathbb{R}(? \text{ToUint32}(y))$ .
3. Let *product* be  $(a \times b)$  modulo  $2^{32}$ .
4. If *product*  $\geq 2^{31}$ , return  $\mathbb{F}(\text{product} - 2^{32})$ ; otherwise return  $\mathbb{F}(\text{product})$ .

### 21.3.2.20 Math.log ( *x* )

This function returns the natural logarithm of *x*.

It performs the following steps when called:

1. Let *n* be ? **ToNumber**(*x*).
2. If *n* is either **NaN** or **+∞<sub>F</sub>**, return *n*.
3. If *n* is **1<sub>F</sub>**, return **+0<sub>F</sub>**.
4. If *n* is either **+0<sub>F</sub>** or **-0<sub>F</sub>**, return **-∞<sub>F</sub>**.
5. If *n* < **-0<sub>F</sub>**, return **NaN**.
6. Return an **implementation-approximated** Number value representing the result of the natural logarithm of  $\mathbb{R}(n)$ .

### 21.3.2.21 Math.log1p ( *x* )

This function returns the natural logarithm of  $1 + x$ . The result is computed in a way that is accurate even when the value of *x* is close to zero.

It performs the following steps when called:

1. Let *n* be ? **ToNumber**(*x*).
2. If *n* is one of **NaN**, **+0<sub>F</sub>**, **-0<sub>F</sub>**, or **+∞<sub>F</sub>**, return *n*.
3. If *n* is **-1<sub>F</sub>**, return **-∞<sub>F</sub>**.
4. If *n* < **-1<sub>F</sub>**, return **NaN**.
5. Return an **implementation-approximated** Number value representing the result of the natural logarithm of  $1 + \mathbb{R}(n)$ .

### 21.3.2.22 Math.log10 ( *x* )

This function returns the base 10 logarithm of *x*.

It performs the following steps when called:

1. Let *n* be ? [ToNumber](#)(*x*).
2. If *n* is either **NaN** or  $+\infty_{\mathbb{F}}$ , return *n*.
3. If *n* is  $1_{\mathbb{F}}$ , return  $+0_{\mathbb{F}}$ .
4. If *n* is either  $+0_{\mathbb{F}}$  or  $-0_{\mathbb{F}}$ , return  $-\infty_{\mathbb{F}}$ .
5. If  $n < -0_{\mathbb{F}}$ , return **NaN**.
6. Return an [implementation-approximated](#) Number value representing the result of the base 10 logarithm of  $\mathbb{R}(n)$ .

### 21.3.2.23 Math.log2 ( *x* )

This function returns the base 2 logarithm of *x*.

It performs the following steps when called:

1. Let *n* be ? [ToNumber](#)(*x*).
2. If *n* is either **NaN** or  $+\infty_{\mathbb{F}}$ , return *n*.
3. If *n* is  $1_{\mathbb{F}}$ , return  $+0_{\mathbb{F}}$ .
4. If *n* is either  $+0_{\mathbb{F}}$  or  $-0_{\mathbb{F}}$ , return  $-\infty_{\mathbb{F}}$ .
5. If  $n < -0_{\mathbb{F}}$ , return **NaN**.
6. Return an [implementation-approximated](#) Number value representing the result of the base 2 logarithm of  $\mathbb{R}(n)$ .

### 21.3.2.24 Math.max ( ...*args* )

Given zero or more arguments, this function calls [ToNumber](#) on each of the arguments and returns the largest of the resulting values.

It performs the following steps when called:

1. Let *coerced* be a new empty [List](#).
2. For each element *arg* of *args*, do
  - a. Let *n* be ? [ToNumber](#)(*arg*).
  - b. Append *n* to *coerced*.
3. Let *highest* be  $-\infty_{\mathbb{F}}$ .
4. For each element *number* of *coerced*, do
  - a. If *number* is **NaN**, return **NaN**.
  - b. If *number* is  $+0_{\mathbb{F}}$  and *highest* is  $-0_{\mathbb{F}}$ , set *highest* to  $+0_{\mathbb{F}}$ .
  - c. If *number* > *highest*, set *highest* to *number*.
5. Return *highest*.

**NOTE** The comparison of values to determine the largest value is done using the [IsLessThan](#) algorithm except that  $+0_{\mathbb{F}}$  is considered to be larger than  $-0_{\mathbb{F}}$ .

The "length" property of this function is 2<sub>F</sub>.

### 21.3.2.25 Math.min ( ...args )

Given zero or more arguments, this function calls [ToNumber](#) on each of the arguments and returns the smallest of the resulting values.

It performs the following steps when called:

1. Let *coerced* be a new empty [List](#).
2. For each element *arg* of *args*, do
  - a. Let *n* be ? [ToNumber](#)(*arg*).
  - b. Append *n* to *coerced*.
3. Let *lowest* be  $+\infty$ <sub>F</sub>.
4. For each element *number* of *coerced*, do
  - a. If *number* is **NaN**, return **NaN**.
  - b. If *number* is  $-0$ <sub>F</sub> and *lowest* is  $+0$ <sub>F</sub>, set *lowest* to  $-0$ <sub>F</sub>.
  - c. If *number* < *lowest*, set *lowest* to *number*.
5. Return *lowest*.

**NOTE** The comparison of values to determine the largest value is done using the [IsLessThan](#) algorithm except that  $+0$ <sub>F</sub> is considered to be larger than  $-0$ <sub>F</sub>.

The "length" property of this function is 2<sub>F</sub>.

### 21.3.2.26 Math.pow ( base, exponent )

This function performs the following steps when called:

1. Set *base* to ? [ToNumber](#)(*base*).
2. Set *exponent* to ? [ToNumber](#)(*exponent*).
3. Return [Number::exponentiate](#)(*base*, *exponent*).

### 21.3.2.27 Math.random ( )

This function returns a [Number](#) value with positive sign, greater than or equal to  $+0$ <sub>F</sub> but strictly less than  $1$ <sub>F</sub>, chosen randomly or pseudo randomly with approximately uniform distribution over that range, using an [implementation-defined](#) algorithm or strategy.

Each [Math.random](#) function created for distinct [realms](#) must produce a distinct sequence of values from successive calls.

### 21.3.2.28 Math.round ( x )

This function returns the [Number](#) value that is closest to *x* and is integral. If two [integral Numbers](#) are equally close to *x*, then the result is the [Number](#) value that is closer to  $+\infty$ . If *x* is already integral, the result is *x*.

It performs the following steps when called:

1. Let *n* be ? [ToNumber](#)(*x*).
2. If *n* is not [finite](#) or *n* is an [integral Number](#), return *n*.

3. If  $n < 0.5_{\mathbb{F}}$  and  $n > +0_{\mathbb{F}}$ , return  $+0_{\mathbb{F}}$ .
4. If  $n < -0_{\mathbb{F}}$  and  $n \geq -0.5_{\mathbb{F}}$ , return  $-0_{\mathbb{F}}$ .
5. Return the **integral Number** closest to  $n$ , preferring the Number closer to  $+\infty$  in the case of a tie.

NOTE 1 `Math.round(3.5)` returns 4, but `Math.round(-3.5)` returns -3.

NOTE 2 The value of `Math.round(x)` is not always the same as the value of `Math.floor(x + 0.5)`. When  $x$  is  $-0_{\mathbb{F}}$  or  $x$  is less than  $+0_{\mathbb{F}}$  but greater than or equal to  $-0.5_{\mathbb{F}}$ , `Math.round(x)` returns  $-0_{\mathbb{F}}$ , but `Math.floor(x + 0.5)` returns  $+0_{\mathbb{F}}$ . `Math.round(x)` may also differ from the value of `Math.floor(x + 0.5)` because of internal rounding when computing  $x + 0.5$ .

### 21.3.2.29 `Math.sign ( x )`

This function returns the sign of  $x$ , indicating whether  $x$  is positive, negative, or zero.

It performs the following steps when called:

1. Let  $n$  be ? `ToNumber(x)`.
2. If  $n$  is one of **NaN**,  $+0_{\mathbb{F}}$ , or  $-0_{\mathbb{F}}$ , return  $n$ .
3. If  $n < -0_{\mathbb{F}}$ , return  $-1_{\mathbb{F}}$ .
4. Return  $1_{\mathbb{F}}$ .

### 21.3.2.30 `Math.sin ( x )`

This function returns the sine of  $x$ . The argument is expressed in radians.

It performs the following steps when called:

1. Let  $n$  be ? `ToNumber(x)`.
2. If  $n$  is one of **NaN**,  $+0_{\mathbb{F}}$ , or  $-0_{\mathbb{F}}$ , return  $n$ .
3. If  $n$  is either  $+\infty_{\mathbb{F}}$  or  $-\infty_{\mathbb{F}}$ , return **NaN**.
4. Return an **implementation-approximated** Number value representing the result of the sine of  $\mathbb{R}(n)$ .

### 21.3.2.31 `Math.sinh ( x )`

This function returns the hyperbolic sine of  $x$ .

It performs the following steps when called:

1. Let  $n$  be ? `ToNumber(x)`.
2. If  $n$  is not **finite** or  $n$  is either  $+0_{\mathbb{F}}$  or  $-0_{\mathbb{F}}$ , return  $n$ .
3. Return an **implementation-approximated** Number value representing the result of the hyperbolic sine of  $\mathbb{R}(n)$ .

NOTE The value of `Math.sinh(x)` is the same as the value of `(Math.exp(x) - Math.exp(-x)) / 2`.

### 21.3.2.32 Math.sqrt ( x )

This function returns the square root of  $x$ .

It performs the following steps when called:

1. Let  $n$  be ? `ToNumber(x)`.
2. If  $n$  is one of **NaN**, **+0<sub>F</sub>**, **-0<sub>F</sub>**, or **+∞<sub>F</sub>**, return  $n$ .
3. If  $n < -0<sub>F</sub>$ , return **NaN**.
4. Return an **implementation-approximated** Number value representing the result of the square root of  $\mathbb{R}(n)$ .

### 21.3.2.33 Math.tan ( x )

This function returns the tangent of  $x$ . The argument is expressed in radians.

It performs the following steps when called:

1. Let  $n$  be ? `ToNumber(x)`.
2. If  $n$  is one of **NaN**, **+0<sub>F</sub>**, or **-0<sub>F</sub>**, return  $n$ .
3. If  $n$  is either **+∞<sub>F</sub>** or **-∞<sub>F</sub>**, return **NaN**.
4. Return an **implementation-approximated** Number value representing the result of the tangent of  $\mathbb{R}(n)$ .

### 21.3.2.34 Math.tanh ( x )

This function returns the hyperbolic tangent of  $x$ .

It performs the following steps when called:

1. Let  $n$  be ? `ToNumber(x)`.
2. If  $n$  is one of **NaN**, **+0<sub>F</sub>**, or **-0<sub>F</sub>**, return  $n$ .
3. If  $n$  is **+∞<sub>F</sub>**, return **1<sub>F</sub>**.
4. If  $n$  is **-∞<sub>F</sub>**, return **-1<sub>F</sub>**.
5. Return an **implementation-approximated** Number value representing the result of the hyperbolic tangent of  $\mathbb{R}(n)$ .

**NOTE** The value of **Math.tanh(x)** is the same as the value of  $(\text{Math.exp}(x) - \text{Math.exp}(-x)) / (\text{Math.exp}(x) + \text{Math.exp}(-x))$ .

### 21.3.2.35 Math.trunc ( x )

This function returns the integral part of the number  $x$ , removing any fractional digits. If  $x$  is already integral, the result is  $x$ .

It performs the following steps when called:

1. Let  $n$  be ? `ToNumber(x)`.
2. If  $n$  is not **finite** or  $n$  is either **+0<sub>F</sub>** or **-0<sub>F</sub>**, return  $n$ .
3. If  $n < 1<sub>F</sub>$  and  $n > +0<sub>F</sub>$ , return **+0<sub>F</sub>**.
4. If  $n < -0<sub>F</sub>$  and  $n > -1<sub>F</sub>$ , return **-0<sub>F</sub>**.



5. Return the **integral Number** nearest  $n$  in the direction of  $+0_{\mathbb{F}}$ .

## 21.4 Date Objects

### 21.4.1 Overview of Date Objects and Definitions of Abstract Operations

The following **abstract operations** operate on **time values** (defined in 21.4.1.1). Note that, in every case, if any argument to one of these functions is **NaN**, the result will be **NaN**.

#### 21.4.1.1 Time Values and Time Range

Time measurement in ECMAScript is analogous to time measurement in POSIX, in particular sharing definition in terms of the proleptic Gregorian calendar, an *epoch* of midnight at the beginning of 1 January 1970 UTC, and an accounting of every day as comprising exactly 86,400 seconds (each of which is 1000 milliseconds long).

An ECMAScript *time value* is a **Number**, either a **finite integral Number** representing an instant in time to millisecond precision or **NaN** representing no specific instant. A time value that is a multiple of  $24 \times 60 \times 60 \times 1000 = 86,400,000$  (i.e., is  $86,400,000 \times d$  for some **integer**  $d$ ) represents the instant at the start of the UTC day that follows the **epoch** by  $d$  whole UTC days (preceding the **epoch** for negative  $d$ ). Every other **finite** time value  $t$  is defined relative to the greatest preceding time value  $s$  that is such a multiple, and represents the instant that occurs within the same UTC day as  $s$  but follows it by  $(t - s)$  milliseconds.

Time values do not account for UTC leap seconds—there are no time values representing instants within positive leap seconds, and there are time values representing instants removed from the UTC timeline by negative leap seconds. However, the definition of time values nonetheless yields piecewise alignment with UTC, with discontinuities only at leap second boundaries and zero difference outside of leap seconds.

A **Number** can exactly represent all **integers** from  $-9,007,199,254,740,992$  to  $9,007,199,254,740,992$  (21.1.2.8 and 21.1.2.6). A time value supports a slightly smaller range of  $-8,640,000,000,000,000$  to  $8,640,000,000,000,000$  milliseconds. This yields a supported time value range of exactly  $-100,000,000$  days to  $100,000,000$  days relative to midnight at the beginning of 1 January 1970 UTC.

The exact moment of midnight at the beginning of 1 January 1970 UTC is represented by the time value  $+0_{\mathbb{F}}$ .

**NOTE** The 400 year cycle of the proleptic Gregorian calendar contains 97 leap years. This yields an average of 365.2425 days per year, which is 31,556,952,000 milliseconds. Therefore, the maximum range a **Number** could represent exactly with millisecond precision is approximately  $-285,426$  to  $285,426$  years relative to 1970. The smaller range supported by a time value as specified in this section is approximately  $-273,790$  to  $273,790$  years relative to 1970.

#### 21.4.1.2 Day Number and Time within Day

A given **time value**  $t$  belongs to day number

$$\text{Day}(t) = \mathbb{F}(\text{floor}(\mathbb{R}(t / \text{msPerDay})))$$

where the number of milliseconds per day is

$$\text{msPerDay} = 86400000_{\mathbb{F}}$$

The remainder is called the time within the day:

$$\text{TimeWithinDay}(t) = \mathbb{F}(\mathbb{R}(t) \bmod \mathbb{R}(\text{msPerDay}))$$

### 21.4.1.3 Year Number

ECMAScript uses a proleptic Gregorian calendar to map a day number to a year number and to determine the month and date within that year. In this calendar, leap years are precisely those which are (divisible by 4) and ((not divisible by 100) or (divisible by 400)). The number of days in year number  $y$  is therefore defined by

$$\begin{aligned} \text{DaysInYear}(y) &= 365_{\mathbb{F}} \text{ if } (\mathbb{R}(y) \bmod 4) \neq 0 \\ &= 366_{\mathbb{F}} \text{ if } (\mathbb{R}(y) \bmod 4) = 0 \text{ and } (\mathbb{R}(y) \bmod 100) \neq 0 \\ &= 365_{\mathbb{F}} \text{ if } (\mathbb{R}(y) \bmod 100) = 0 \text{ and } (\mathbb{R}(y) \bmod 400) \neq 0 \\ &= 366_{\mathbb{F}} \text{ if } (\mathbb{R}(y) \bmod 400) = 0 \end{aligned}$$

All non-leap years have 365 days with the usual number of days per month and leap years have an extra day in February. The day number of the first day of year  $y$  is given by:

$$\text{DayFromYear}(y) = \mathbb{F}(365 \times (\mathbb{R}(y) - 1970) + \text{floor}((\mathbb{R}(y) - 1969) / 4) - \text{floor}((\mathbb{R}(y) - 1901) / 100) + \text{floor}((\mathbb{R}(y) - 1601) / 400))$$

The **time value** of the start of a year is:

$$\text{TimeFromYear}(y) = \text{msPerDay} \times \text{DayFromYear}(y)$$

A **time value** determines a year by:

$$\text{YearFromTime}(t) = \text{the largest integral Number } y \text{ (closest to } +\infty) \text{ such that } \text{TimeFromYear}(y) \leq t$$

The leap-year function is  $1_{\mathbb{F}}$  for a time within a leap year and otherwise is  $+0_{\mathbb{F}}$ :

$$\begin{aligned} \text{InLeapYear}(t) &= +0_{\mathbb{F}} \text{ if } \text{DaysInYear}(\text{YearFromTime}(t)) \text{ is } 365_{\mathbb{F}} \\ &= 1_{\mathbb{F}} \text{ if } \text{DaysInYear}(\text{YearFromTime}(t)) \text{ is } 366_{\mathbb{F}} \end{aligned}$$

### 21.4.1.4 Month Number

Months are identified by an **integral Number** in the **inclusive interval** from  $+0_{\mathbb{F}}$  to  $11_{\mathbb{F}}$ . The mapping **MonthFromTime**( $t$ ) from a **time value**  $t$  to a month number is defined by:

$$\begin{aligned} \text{MonthFromTime}(t) &= +0_{\mathbb{F}} \text{ if } +0_{\mathbb{F}} \leq \text{DayWithinYear}(t) < 31_{\mathbb{F}} \\ &= 1_{\mathbb{F}} \text{ if } 31_{\mathbb{F}} \leq \text{DayWithinYear}(t) < 59_{\mathbb{F}} + \text{InLeapYear}(t) \\ &= 2_{\mathbb{F}} \text{ if } 59_{\mathbb{F}} + \text{InLeapYear}(t) \leq \text{DayWithinYear}(t) < 90_{\mathbb{F}} + \text{InLeapYear}(t) \\ &= 3_{\mathbb{F}} \text{ if } 90_{\mathbb{F}} + \text{InLeapYear}(t) \leq \text{DayWithinYear}(t) < 120_{\mathbb{F}} + \text{InLeapYear}(t) \\ &= 4_{\mathbb{F}} \text{ if } 120_{\mathbb{F}} + \text{InLeapYear}(t) \leq \text{DayWithinYear}(t) < 151_{\mathbb{F}} + \text{InLeapYear}(t) \\ &= 5_{\mathbb{F}} \text{ if } 151_{\mathbb{F}} + \text{InLeapYear}(t) \leq \text{DayWithinYear}(t) < 181_{\mathbb{F}} + \text{InLeapYear}(t) \\ &= 6_{\mathbb{F}} \text{ if } 181_{\mathbb{F}} + \text{InLeapYear}(t) \leq \text{DayWithinYear}(t) < 212_{\mathbb{F}} + \text{InLeapYear}(t) \\ &= 7_{\mathbb{F}} \text{ if } 212_{\mathbb{F}} + \text{InLeapYear}(t) \leq \text{DayWithinYear}(t) < 243_{\mathbb{F}} + \text{InLeapYear}(t) \\ &= 8_{\mathbb{F}} \text{ if } 243_{\mathbb{F}} + \text{InLeapYear}(t) \leq \text{DayWithinYear}(t) < 273_{\mathbb{F}} + \text{InLeapYear}(t) \\ &= 9_{\mathbb{F}} \text{ if } 273_{\mathbb{F}} + \text{InLeapYear}(t) \leq \text{DayWithinYear}(t) < 304_{\mathbb{F}} + \text{InLeapYear}(t) \\ &= 10_{\mathbb{F}} \text{ if } 304_{\mathbb{F}} + \text{InLeapYear}(t) \leq \text{DayWithinYear}(t) < 334_{\mathbb{F}} + \text{InLeapYear}(t) \\ &= 11_{\mathbb{F}} \text{ if } 334_{\mathbb{F}} + \text{InLeapYear}(t) \leq \text{DayWithinYear}(t) < 365_{\mathbb{F}} + \text{InLeapYear}(t) \end{aligned}$$

where

$$\text{DayWithinYear}(t) = \text{Day}(t) - \text{DayFromYear}(\text{YearFromTime}(t))$$

A month value of  $+0_{\text{F}}$  specifies January;  $1_{\text{F}}$  specifies February;  $2_{\text{F}}$  specifies March;  $3_{\text{F}}$  specifies April;  $4_{\text{F}}$  specifies May;  $5_{\text{F}}$  specifies June;  $6_{\text{F}}$  specifies July;  $7_{\text{F}}$  specifies August;  $8_{\text{F}}$  specifies September;  $9_{\text{F}}$  specifies October;  $10_{\text{F}}$  specifies November; and  $11_{\text{F}}$  specifies December. Note that  $\text{MonthFromTime}(+0_{\text{F}}) = +0_{\text{F}}$ , corresponding to Thursday, 1 January 1970.

### 21.4.1.5 Date Number

A date number is identified by an **integral Number** in the **inclusive interval** from  $1_{\text{F}}$  to  $31_{\text{F}}$ . The mapping  $\text{DateFromTime}(t)$  from a **time value**  $t$  to a date number is defined by:

$$\begin{aligned} \text{DateFromTime}(t) &= \text{DayWithinYear}(t) + 1_{\text{F}} \text{ if } \text{MonthFromTime}(t) \text{ is } +0_{\text{F}} \\ &= \text{DayWithinYear}(t) - 30_{\text{F}} \text{ if } \text{MonthFromTime}(t) \text{ is } 1_{\text{F}} \\ &= \text{DayWithinYear}(t) - 58_{\text{F}} - \text{InLeapYear}(t) \text{ if } \text{MonthFromTime}(t) \text{ is } 2_{\text{F}} \\ &= \text{DayWithinYear}(t) - 89_{\text{F}} - \text{InLeapYear}(t) \text{ if } \text{MonthFromTime}(t) \text{ is } 3_{\text{F}} \\ &= \text{DayWithinYear}(t) - 119_{\text{F}} - \text{InLeapYear}(t) \text{ if } \text{MonthFromTime}(t) \text{ is } 4_{\text{F}} \\ &= \text{DayWithinYear}(t) - 150_{\text{F}} - \text{InLeapYear}(t) \text{ if } \text{MonthFromTime}(t) \text{ is } 5_{\text{F}} \\ &= \text{DayWithinYear}(t) - 180_{\text{F}} - \text{InLeapYear}(t) \text{ if } \text{MonthFromTime}(t) \text{ is } 6_{\text{F}} \\ &= \text{DayWithinYear}(t) - 211_{\text{F}} - \text{InLeapYear}(t) \text{ if } \text{MonthFromTime}(t) \text{ is } 7_{\text{F}} \\ &= \text{DayWithinYear}(t) - 242_{\text{F}} - \text{InLeapYear}(t) \text{ if } \text{MonthFromTime}(t) \text{ is } 8_{\text{F}} \\ &= \text{DayWithinYear}(t) - 272_{\text{F}} - \text{InLeapYear}(t) \text{ if } \text{MonthFromTime}(t) \text{ is } 9_{\text{F}} \\ &= \text{DayWithinYear}(t) - 303_{\text{F}} - \text{InLeapYear}(t) \text{ if } \text{MonthFromTime}(t) \text{ is } 10_{\text{F}} \\ &= \text{DayWithinYear}(t) - 333_{\text{F}} - \text{InLeapYear}(t) \text{ if } \text{MonthFromTime}(t) \text{ is } 11_{\text{F}} \end{aligned}$$

### 21.4.1.6 Week Day

The weekday for a particular **time value**  $t$  is defined as

$$\text{WeekDay}(t) = \mathbb{F}(\mathbb{R}(\text{Day}(t) + 4_{\text{F}}) \text{ modulo } 7)$$

A weekday value of  $+0_{\text{F}}$  specifies Sunday;  $1_{\text{F}}$  specifies Monday;  $2_{\text{F}}$  specifies Tuesday;  $3_{\text{F}}$  specifies Wednesday;  $4_{\text{F}}$  specifies Thursday;  $5_{\text{F}}$  specifies Friday; and  $6_{\text{F}}$  specifies Saturday. Note that  $\text{WeekDay}(+0_{\text{F}}) = 4_{\text{F}}$ , corresponding to Thursday, 1 January 1970.

### 21.4.1.7 GetUTCEpochNanoseconds ( *year*, *month*, *day*, *hour*, *minute*, *second*, *millisecond*, *microsecond*, *nanosecond* )

The abstract operation `GetUTCEpochNanoseconds` takes arguments *year* (an **integer**), *month* (an **integer** in the **inclusive interval** from 1 to 12), *day* (an **integer** in the **inclusive interval** from 1 to 31), *hour* (an **integer** in the **inclusive interval** from 0 to 23), *minute* (an **integer** in the **inclusive interval** from 0 to 59), *second* (an **integer** in the **inclusive interval** from 0 to 59), *millisecond* (an **integer** in the **inclusive interval** from 0 to 999), *microsecond* (an **integer** in the **inclusive interval** from 0 to 999), and *nanosecond* (an **integer** in the **inclusive interval** from 0 to 999) and returns a `BigInt`. The returned value represents a number of nanoseconds since the **epoch** that corresponds to the given ISO 8601 calendar date and wall-clock time in UTC. It performs the following steps when called:

1. Let *date* be `MakeDay`( $\mathbb{F}(\text{year})$ ,  $\mathbb{F}(\text{month} - 1)$ ,  $\mathbb{F}(\text{day})$ ).
2. Let *time* be `MakeTime`( $\mathbb{F}(\text{hour})$ ,  $\mathbb{F}(\text{minute})$ ,  $\mathbb{F}(\text{second})$ ,  $\mathbb{F}(\text{millisecond})$ ).
3. Let *ms* be `MakeDate`(*date*, *time*).
4. **Assert**: *ms* is an **integral Number**.

5. Return  $\mathbb{Z}(\mathbb{R}(ms) \times 10^6 + \text{microsecond} \times 10^3 + \text{nanosecond})$ .

#### 21.4.1.8 GetNamedTimeZoneEpochNanoseconds ( *timeZoneIdentifier*, *year*, *month*, *day*, *hour*, *minute*, *second*, *millisecond*, *microsecond*, *nanosecond* )

The *implementation-defined* abstract operation GetNamedTimeZoneEpochNanoseconds takes arguments *timeZoneIdentifier* (a String), *year* (an integer), *month* (an integer in the *inclusive interval* from 1 to 12), *day* (an integer in the *inclusive interval* from 1 to 31), *hour* (an integer in the *inclusive interval* from 0 to 23), *minute* (an integer in the *inclusive interval* from 0 to 59), *second* (an integer in the *inclusive interval* from 0 to 59), *millisecond* (an integer in the *inclusive interval* from 0 to 999), *microsecond* (an integer in the *inclusive interval* from 0 to 999), and *nanosecond* (an integer in the *inclusive interval* from 0 to 999) and returns a List of BigInts. Each value in the returned List represents a number of nanoseconds since the *epoch* that corresponds to the given ISO 8601 calendar date and wall-clock time in the named time zone identified by *timeZoneIdentifier*.

When the input represents a local time occurring more than once because of a negative time zone transition (e.g. when daylight saving time ends or the time zone offset is decreased due to a time zone rule change), the returned List will have more than one element and will be sorted by ascending numerical value. When the input represents a local time skipped because of a positive time zone transition (e.g. when daylight saving time begins or the time zone offset is increased due to a time zone rule change), the returned List will be empty. Otherwise, the returned List will have one element.

The default implementation of GetNamedTimeZoneEpochNanoseconds, to be used for ECMAScript implementations that do not include local political rules for any time zones, performs the following steps when called:

1. Assert: *timeZoneIdentifier* is "UTC".
2. Let *epochNanoseconds* be GetUTCEpochNanoseconds(*year*, *month*, *day*, *hour*, *minute*, *second*, *millisecond*, *microsecond*, *nanosecond*).
3. Return « *epochNanoseconds* ».

**NOTE** It is recommended that implementations use the time zone information of the IANA Time Zone Database <https://www.iana.org/time-zones/>.

1:30 AM on 5 November 2017 in America/New\_York is repeated twice, so GetNamedTimeZoneEpochNanoseconds("America/New\_York", 2017, 11, 5, 1, 30, 0, 0, 0, 0) would return a List of length 2 in which the first element represents 05:30 UTC (corresponding with 01:30 US Eastern Daylight Time at UTC offset -04:00) and the second element represents 06:30 UTC (corresponding with 01:30 US Eastern Standard Time at UTC offset -05:00).

2:30 AM on 12 March 2017 in America/New\_York does not exist, so GetNamedTimeZoneEpochNanoseconds("America/New\_York", 2017, 3, 12, 2, 30, 0, 0, 0, 0) would return an empty List.

#### 21.4.1.9 GetNamedTimeZoneOffsetNanoseconds ( *timeZoneIdentifier*, *epochNanoseconds* )

The *implementation-defined* abstract operation GetNamedTimeZoneOffsetNanoseconds takes arguments *timeZoneIdentifier* (a String) and *epochNanoseconds* (a BigInt) and returns an integer.

The returned integer represents the offset from UTC of the named time zone identified by *timeZoneIdentifier*, at the instant corresponding with *epochNanoseconds* relative to the *epoch*, both in nanoseconds.

The default implementation of GetNamedTimeZoneOffsetNanoseconds, to be used for ECMAScript implementations that do not include local political rules for any time zones, performs the following steps when called:

1. Assert: *timeZoneIdentifier* is "UTC".
2. Return 0.

NOTE Time zone offset values may be positive or negative.

#### 21.4.1.10 DefaultTimeZone ( )

The *implementation-defined* abstract operation DefaultTimeZone takes no arguments and returns a String. It returns a String value representing the *host environment*'s current time zone, which is either a String representing a UTC offset for which *IsTimeZoneOffsetString* returns **true**, or a String identifier accepted by *GetNamedTimeZoneEpochNanoseconds* and *GetNamedTimeZoneOffsetNanoseconds*.

An ECMAScript implementation that includes the ECMA-402 Internationalization API must implement the DefaultTimeZone abstract operation as specified in the ECMA-402 specification.

The default implementation of DefaultTimeZone, to be used for ECMAScript implementations that do not include local political rules for any time zones, performs the following steps when called:

1. Return "UTC".

NOTE To ensure the level of functionality that implementations commonly provide in the methods of the Date object, it is recommended that DefaultTimeZone return an IANA time zone name corresponding to the *host environment*'s time zone setting, if such a thing exists. *GetNamedTimeZoneEpochNanoseconds* and *GetNamedTimeZoneOffsetNanoseconds* must reflect the local political rules for standard time and daylight saving time in that time zone, if such rules exist.

For example, if the *host environment* is a browser on a system where the user has chosen US Eastern Time as their time zone, DefaultTimeZone returns "America/New\_York".

#### 21.4.1.11 LocalTime ( *t* )

The abstract operation LocalTime takes argument *t* (a *finite time value*) and returns an *integral Number*. It converts *t* from UTC to local time. The local political rules for standard time and daylight saving time in effect at *t* should be used to determine the result in the way specified in this section. It performs the following steps when called:

1. Let *localTimeZone* be DefaultTimeZone().
2. If *IsTimeZoneOffsetString*(*localTimeZone*) is **true**, then
  - a. Let *offsetNs* be *ParseTimeZoneOffsetString*(*localTimeZone*).
3. Else,
  - a. Let *offsetNs* be *GetNamedTimeZoneOffsetNanoseconds*(*localTimeZone*,  $\mathbb{Z}(\mathbb{R}(t) \times 10^6)$ ).
4. Let *offsetMs* be *truncate*(*offsetNs* /  $10^6$ ).
5. Return  $t + \mathbb{F}(\textit{offsetMs})$ .

If political rules for the local time *t* are not available within the implementation, the result is *t* because *DefaultTimeZone* returns "UTC" and *GetNamedTimeZoneOffsetNanoseconds* returns 0.

NOTE 1 It is recommended that implementations use the time zone information of the IANA Time Zone Database <https://www.iana.org/time-zones/>.

NOTE 2 Two different input **time values**  $t_{UTC}$  are converted to the same local time  $t_{local}$  at a negative time zone transition when there are repeated times (e.g. the daylight saving time ends or the time zone adjustment is decreased.).

LocalTime(UTC( $t_{local}$ )) is not necessarily always equal to  $t_{local}$ . Correspondingly, UTC(LocalTime( $t_{UTC}$ )) is not necessarily always equal to  $t_{UTC}$ .

### 21.4.1.12 UTC ( $t$ )

The abstract operation UTC takes argument  $t$  (a Number) and returns a **time value**. It converts  $t$  from local time to a UTC **time value**. The local political rules for standard time and daylight saving time in effect at  $t$  should be used to determine the result in the way specified in this section. It performs the following steps when called:

1. Let *localTimeZone* be DefaultTimeZone().
2. If IsTimeZoneOffsetString(*localTimeZone*) is **true**, then
  - a. Let *offsetNs* be ParseTimeZoneOffsetString(*localTimeZone*).
3. Else,
  - a. Let *possibleInstants* be GetNamedTimeZoneEpochNanoseconds(*localTimeZone*,  $\mathbb{R}(\text{YearFromTime}(t))$ ,  $\mathbb{R}(\text{MonthFromTime}(t)) + 1$ ,  $\mathbb{R}(\text{DateFromTime}(t))$ ,  $\mathbb{R}(\text{HourFromTime}(t))$ ,  $\mathbb{R}(\text{MinFromTime}(t))$ ,  $\mathbb{R}(\text{SecFromTime}(t))$ ,  $\mathbb{R}(\text{msFromTime}(t))$ , 0, 0).
  - b. NOTE: The following steps ensure that when  $t$  represents local time repeating multiple times at a negative time zone transition (e.g. when the daylight saving time ends or the time zone offset is decreased due to a time zone rule change) or skipped local time at a positive time zone transition (e.g. when the daylight saving time starts or the time zone offset is increased due to a time zone rule change),  $t$  is interpreted using the time zone offset before the transition.
  - c. If *possibleInstants* is not empty, then
    - i. Let *disambiguatedInstant* be *possibleInstants*[0].
  - d. Else,
    - i. NOTE:  $t$  represents a local time skipped at a positive time zone transition (e.g. due to daylight saving time starting or a time zone rule change increasing the UTC offset).
    - ii. Let *possibleInstantsBefore* be GetNamedTimeZoneEpochNanoseconds(*localTimeZone*,  $\mathbb{R}(\text{YearFromTime}(tBefore))$ ,  $\mathbb{R}(\text{MonthFromTime}(tBefore)) + 1$ ,  $\mathbb{R}(\text{DateFromTime}(tBefore))$ ,  $\mathbb{R}(\text{HourFromTime}(tBefore))$ ,  $\mathbb{R}(\text{MinFromTime}(tBefore))$ ,  $\mathbb{R}(\text{SecFromTime}(tBefore))$ ,  $\mathbb{R}(\text{msFromTime}(tBefore))$ , 0, 0), where *tBefore* is the largest integral Number  $< t$  for which *possibleInstantsBefore* is not empty (i.e., *tBefore* represents the last local time before the transition).
    - iii. Let *disambiguatedInstant* be the last element of *possibleInstantsBefore*.
  - e. Let *offsetNs* be GetNamedTimeZoneOffsetNanoseconds(*localTimeZone*, *disambiguatedInstant*).
4. Let *offsetMs* be truncate(*offsetNs* /  $10^6$ ).
5. Return  $t - \mathbb{F}(\text{offsetMs})$ .

Input  $t$  is nominally a **time value** but may be any Number value. The algorithm must not limit  $t$  to the **time value** range, so that inputs corresponding with a boundary of the **time value** range can be supported regardless of local UTC offset. For example, the maximum **time value** is  $8.64 \times 10^{15}$ , corresponding with "+275760-09-13T00:00:00Z". In an environment where the local time zone offset is ahead of UTC by 1 hour at that instant, it is represented by the larger input of  $8.64 \times 10^{15} + 3.6 \times 10^6$ , corresponding with "+275760-09-13T01:00:00+01:00".

If political rules for the local time  $t$  are not available within the implementation, the result is  $t$  because DefaultTimeZone returns "UTC" and GetNamedTimeZoneOffsetNanoseconds returns 0.

NOTE 1 It is recommended that implementations use the time zone information of the IANA Time Zone Database <https://www.iana.org/time-zones/>.

1:30 AM on 5 November 2017 in America/New\_York is repeated twice (fall backward), but it must be interpreted as 1:30 AM UTC-04 instead of 1:30 AM UTC-05. In  $\text{UTC}(\text{TimeClip}(\text{MakeDate}(\text{MakeDay}(2017, 10, 5), \text{MakeTime}(1, 30, 0, 0))))$ , the value of *offsetMs* is  $-4 \times \text{msPerHour}$ .

2:30 AM on 12 March 2017 in America/New\_York does not exist, but it must be interpreted as 2:30 AM UTC-05 (equivalent to 3:30 AM UTC-04). In  $\text{UTC}(\text{TimeClip}(\text{MakeDate}(\text{MakeDay}(2017, 2, 12), \text{MakeTime}(2, 30, 0, 0))))$ , the value of *offsetMs* is  $-5 \times \text{msPerHour}$ .

NOTE 2  $\text{UTC}(\text{LocalTime}(t_{\text{UTC}}))$  is not necessarily always equal to  $t_{\text{UTC}}$ . Correspondingly,  $\text{LocalTime}(\text{UTC}(t_{\text{local}}))$  is not necessarily always equal to  $t_{\text{local}}$ .

### 21.4.1.13 Hours, Minutes, Second, and Milliseconds

The following **abstract operations** are useful in decomposing **time values**:

$\text{HourFromTime}(t) = \mathbb{F}(\text{floor}(\mathbb{R}(t / \text{msPerHour})) \text{ modulo } \text{HoursPerDay})$   
 $\text{MinFromTime}(t) = \mathbb{F}(\text{floor}(\mathbb{R}(t / \text{msPerMinute})) \text{ modulo } \text{MinutesPerHour})$   
 $\text{SecFromTime}(t) = \mathbb{F}(\text{floor}(\mathbb{R}(t / \text{msPerSecond})) \text{ modulo } \text{SecondsPerMinute})$   
 $\text{msFromTime}(t) = \mathbb{F}(\mathbb{R}(t) \text{ modulo } \mathbb{R}(\text{msPerSecond}))$

where

$\text{HoursPerDay} = 24$   
 $\text{MinutesPerHour} = 60$   
 $\text{SecondsPerMinute} = 60$   
 $\text{msPerSecond} = 1000_{\mathbb{F}}$   
 $\text{msPerMinute} = 60000_{\mathbb{F}} = \text{msPerSecond} \times \mathbb{F}(\text{SecondsPerMinute})$   
 $\text{msPerHour} = 3600000_{\mathbb{F}} = \text{msPerMinute} \times \mathbb{F}(\text{MinutesPerHour})$

### 21.4.1.14 MakeTime ( *hour*, *min*, *sec*, *ms* )

The abstract operation **MakeTime** takes arguments *hour* (a Number), *min* (a Number), *sec* (a Number), and *ms* (a Number) and returns a Number. It calculates a number of milliseconds. It performs the following steps when called:

1. If *hour* is not **finite**, *min* is not **finite**, *sec* is not **finite**, or *ms* is not **finite**, return **NaN**.
2. Let *h* be  $\mathbb{F}(! \text{ToIntegerOrInfinity}(\text{hour}))$ .
3. Let *m* be  $\mathbb{F}(! \text{ToIntegerOrInfinity}(\text{min}))$ .
4. Let *s* be  $\mathbb{F}(! \text{ToIntegerOrInfinity}(\text{sec}))$ .
5. Let *milli* be  $\mathbb{F}(! \text{ToIntegerOrInfinity}(\text{ms}))$ .
6. Let *t* be  $((h * \text{msPerHour} + m * \text{msPerMinute}) + s * \text{msPerSecond}) + \text{milli}$ , performing the arithmetic according to [IEEE 754-2019](#) rules (that is, as if using the ECMAScript operators **\*** and **+**).
7. Return *t*.

### 21.4.1.15 MakeDay ( *year*, *month*, *date* )

The abstract operation MakeDay takes arguments *year* (a Number), *month* (a Number), and *date* (a Number) and returns a Number. It calculates a number of days. It performs the following steps when called:

1. If *year* is not *finite*, *month* is not *finite*, or *date* is not *finite*, return **NaN**.
2. Let *y* be  $\mathbb{F}(! \text{ToIntegerOrInfinity}(\textit{year}))$ .
3. Let *m* be  $\mathbb{F}(! \text{ToIntegerOrInfinity}(\textit{month}))$ .
4. Let *dt* be  $\mathbb{F}(! \text{ToIntegerOrInfinity}(\textit{date}))$ .
5. Let *ym* be  $y + \mathbb{F}(\text{floor}(\mathbb{R}(m) / 12))$ .
6. If *ym* is not *finite*, return **NaN**.
7. Let *mn* be  $\mathbb{F}(\mathbb{R}(m) \bmod 12)$ .
8. Find a *finite time value* *t* such that  $\text{YearFromTime}(t)$  is *ym*,  $\text{MonthFromTime}(t)$  is *mn*, and  $\text{DateFromTime}(t)$  is  $1_{\mathbb{F}}$ ; but if this is not possible (because some argument is out of range), return **NaN**.
9. Return  $\text{Day}(t) + dt - 1_{\mathbb{F}}$ .

### 21.4.1.16 MakeDate ( *day*, *time* )

The abstract operation MakeDate takes arguments *day* (a Number) and *time* (a Number) and returns a Number. It calculates a number of milliseconds. It performs the following steps when called:

1. If *day* is not *finite* or *time* is not *finite*, return **NaN**.
2. Let *tv* be  $day \times \text{msPerDay} + time$ .
3. If *tv* is not *finite*, return **NaN**.
4. Return *tv*.

### 21.4.1.17 TimeClip ( *time* )

The abstract operation TimeClip takes argument *time* (a Number) and returns a Number. It calculates a number of milliseconds. It performs the following steps when called:

1. If *time* is not *finite*, return **NaN**.
2. If  $\text{abs}(\mathbb{R}(\textit{time})) > 8.64 \times 10^{15}$ , return **NaN**.
3. Return  $\mathbb{F}(! \text{ToIntegerOrInfinity}(\textit{time}))$ .

### 21.4.1.18 Date Time String Format

ECMAScript defines a string interchange format for date-times based upon a simplification of the ISO 8601 calendar date extended format. The format is as follows: **YYYY-MM-DDTHH:mm:ss.sssZ**

Where the elements are as follows:

- YYYY** is the year in the proleptic Gregorian calendar as four decimal digits from 0000 to 9999, or as an *expanded year* of "+" or "-" followed by six decimal digits.
- "-" (hyphen) appears literally twice in the string.
- MM** is the month of the year as two decimal digits from 01 (January) to 12 (December).
- DD** is the day of the month as two decimal digits from 01 to 31.
- T** "T" appears literally in the string, to indicate the beginning of the time element.
- HH** is the number of complete hours that have passed since midnight as two decimal digits from 00 to 24.
- :
- mm** is the number of complete minutes since the start of the hour as two decimal digits from 00 to 59.



- ss** is the number of complete seconds since the start of the minute as two decimal digits from 00 to 59.
- .** "." (dot) appears literally in the string.
- sss** is the number of complete milliseconds since the start of the second as three decimal digits.
- Z** is the UTC offset representation specified as "Z" (for UTC with no offset) or as either "+" or "-" followed by a time expression **HH:mm** (a subset of the [time zone offset string format](#) for indicating local time ahead of or behind UTC, respectively)

This format includes date-only forms:

YYYY  
 YYYY-MM  
 YYYY-MM-DD

It also includes "date-time" forms that consist of one of the above date-only forms immediately followed by one of the following time forms with an optional UTC offset representation appended:

THH:mm  
 THH:mm:ss  
 THH:mm:ss.sss

A string containing out-of-bounds or nonconforming elements is not a valid instance of this format.

**NOTE 1** As every day both starts and ends with midnight, the two notations **00:00** and **24:00** are available to distinguish the two midnights that can be associated with one date. This means that the following two notations refer to exactly the same point in time: **1995-02-04T24:00** and **1995-02-05T00:00**. This interpretation of the latter form as "end of a calendar day" is consistent with ISO 8601, even though that specification reserves it for describing time intervals and does not permit it within representations of single points in time.

**NOTE 2** There exists no international standard that specifies abbreviations for civil time zones like CET, EST, etc. and sometimes the same abbreviation is even used for two very different time zones. For this reason, both ISO 8601 and this format specify numeric representations of time zone offsets.

### 21.4.1.18.1 Expanded Years

Covering the full [time value](#) range of approximately 273,790 years forward or backward from 1 January 1970 ([21.4.1.1](#)) requires representing years before 0 or after 9999. ISO 8601 permits expansion of the year representation, but only by mutual agreement of the partners in information interchange. In the simplified ECMAScript format, such an expanded year representation shall have 6 digits and is always prefixed with a + or - sign. The year 0 is considered positive and must be prefixed with a + sign. The representation of the year 0 as -000000 is invalid. Strings matching the [Date Time String Format](#) with expanded years representing instants in time outside the range of a [time value](#) are treated as unrecognizable by [Date.parse](#) and cause that function to return **NaN** without falling back to implementation-specific behaviour or heuristics.

**NOTE** Examples of date-time values with expanded years:

-271821-04-20T00:00:00Z	271822 B.C.
-000001-01-01T00:00:00Z	2 B.C.
+000000-01-01T00:00:00Z	1 B.C.
+000001-01-01T00:00:00Z	1 A.D.
+001970-01-01T00:00:00Z	1970 A.D.
+002009-12-15T00:00:00Z	2009 A.D.
+275760-09-13T00:00:00Z	275760 A.D.

### 21.4.1.19 Time Zone Offset String Format

ECMAScript defines a string interchange format for UTC offsets, derived from ISO 8601. The format is described by the following grammar. The usage of Unicode code points in this grammar is listed in [Table 60](#).

Table 60: Time Zone Offset String Code Points

Code Point	Unicode Name	Abbreviation
U+2212	MINUS SIGN	<MINUS>

#### Syntax

*UTCOffset* :::

*TemporalSign* *Hour*

*TemporalSign* *Hour* *HourSubcomponents*<sub>[+Extended]</sub>

*TemporalSign* *Hour* *HourSubcomponents*<sub>[~Extended]</sub>

*TemporalSign* :::

*ASCIISign*

<MINUS>

*ASCIISign* ::: **one of**

+ -

*Hour* :::

**0** *DecimalDigit*

**1** *DecimalDigit*

**20**

**21**

**22**

**23**

*HourSubcomponents*<sub>[Extended]</sub> :::

*TimeSeparator*<sub>[?Extended]</sub> *MinuteSecond*

*TimeSeparator*<sub>[?Extended]</sub> *MinuteSecond* *TimeSeparator*<sub>[?Extended]</sub> *MinuteSecond*

*TemporalDecimalFraction*<sub>opt</sub>

*TimeSeparator*<sub>[Extended]</sub> :::

<sub>[+Extended]</sub> :

<sub>[~Extended]</sub> [empty]

*MinuteSecond* :::

**0** *DecimalDigit*

**1** *DecimalDigit*

**2** *DecimalDigit*

**3** *DecimalDigit*

**4** *DecimalDigit*

**5** *DecimalDigit*

*TemporalDecimalFraction* :::

*TemporalDecimalSeparator* *DecimalDigit*

*TemporalDecimalSeparator* *DecimalDigit* *DecimalDigit*

*TemporalDecimalSeparator* *DecimalDigit* *DecimalDigit* *DecimalDigit*

*TemporalDecimalSeparator* *DecimalDigit* *DecimalDigit* *DecimalDigit* *DecimalDigit*  
*TemporalDecimalSeparator* *DecimalDigit* *DecimalDigit* *DecimalDigit* *DecimalDigit*  
*DecimalDigit*  
*TemporalDecimalSeparator* *DecimalDigit* *DecimalDigit* *DecimalDigit* *DecimalDigit*  
*DecimalDigit* *DecimalDigit*  
*TemporalDecimalSeparator* *DecimalDigit* *DecimalDigit* *DecimalDigit* *DecimalDigit*  
*DecimalDigit* *DecimalDigit* *DecimalDigit* *DecimalDigit*  
*TemporalDecimalSeparator* *DecimalDigit* *DecimalDigit* *DecimalDigit* *DecimalDigit*  
*DecimalDigit* *DecimalDigit* *DecimalDigit* *DecimalDigit* *DecimalDigit*  
*TemporalDecimalSeparator* *DecimalDigit* *DecimalDigit* *DecimalDigit* *DecimalDigit*  
*DecimalDigit* *DecimalDigit* *DecimalDigit* *DecimalDigit* *DecimalDigit*

*TemporalDecimalSeparator* ::: one of

• ,

#### 21.4.1.19.1 IsTimeZoneOffsetString ( *offsetString* )

The abstract operation IsTimeZoneOffsetString takes argument *offsetString* (a String) and returns a Boolean. The return value indicates whether *offsetString* conforms to the grammar given by *UTCOffset*. It performs the following steps when called:

1. Let *parseResult* be `ParseText(StringToCodePoints(offsetString), UTCOffset)`.
2. If *parseResult* is a List of errors, return **false**.
3. Return **true**.

#### 21.4.1.19.2 ParseTimeZoneOffsetString ( *offsetString* )

The abstract operation ParseTimeZoneOffsetString takes argument *offsetString* (a String) and returns an integer. The return value is the UTC offset, as a number of nanoseconds, that corresponds to the String *offsetString*. It performs the following steps when called:

1. Let *parseResult* be `ParseText(StringToCodePoints(offsetString), UTCOffset)`.
2. **Assert**: *parseResult* is not a List of errors.
3. **Assert**: *parseResult* contains a *TemporalSign Parse Node*.
4. Let *parsedSign* be the source text matched by the *TemporalSign Parse Node* contained within *parseResult*.
5. If *parsedSign* is the single code point U+002D (HYPHEN-MINUS) or U+2212 (MINUS SIGN), then
  - a. Let *sign* be -1.
6. Else,
  - a. Let *sign* be 1.
7. NOTE: Applications of `StringToNumber` below do not lose precision, since each of the parsed values is guaranteed to be a sufficiently short string of decimal digits.
8. **Assert**: *parseResult* contains an *Hour Parse Node*.
9. Let *parsedHours* be the source text matched by the *Hour Parse Node* contained within *parseResult*.
10. Let *hours* be  $\mathbb{R}(\text{StringToNumber}(\text{CodePointsToString}(\text{parsedHours})))$ .
11. If *parseResult* does not contain a *MinuteSecond Parse Node*, then
  - a. Let *minutes* be 0.
12. Else,
  - a. Let *parsedMinutes* be the source text matched by the first *MinuteSecond Parse Node* contained within *parseResult*.
  - b. Let *minutes* be  $\mathbb{R}(\text{StringToNumber}(\text{CodePointsToString}(\text{parsedMinutes})))$ .
13. If *parseResult* does not contain two *MinuteSecond Parse Nodes*, then
  - a. Let *seconds* be 0.
14. Else,

- a. Let *parsedSeconds* be the source text matched by the second *MinuteSecond Parse Node* contained within *parseResult*.
  - b. Let *seconds* be  $\mathbb{R}(\text{StringToNumber}(\text{CodePointsToString}(\text{parsedSeconds})))$ .
15. If *parseResult* does not contain a *TemporalDecimalFraction Parse Node*, then
- a. Let *nanoseconds* be 0.
16. Else,
- a. Let *parsedFraction* be the source text matched by the *TemporalDecimalFraction Parse Node* contained within *parseResult*.
  - b. Let *fraction* be the string-concatenation of  $\text{CodePointsToString}(\text{parsedFraction})$  and "00000000".
  - c. Let *nanosecondsString* be the substring of *fraction* from 1 to 10.
  - d. Let *nanoseconds* be  $\mathbb{R}(\text{StringToNumber}(\text{nanosecondsString}))$ .
17. Return  $\text{sign} \times (((\text{hours} \times 60 + \text{minutes}) \times 60 + \text{seconds}) \times 10^9 + \text{nanoseconds})$ .

## 21.4.2 The Date Constructor

The Date constructor:

- is `%Date%`.
- is the initial value of the "Date" property of the global object.
- creates and initializes a new Date when called as a constructor.
- returns a String representing the current time (UTC) when called as a function rather than as a constructor.
- is a function whose behaviour differs based upon the number and types of its arguments.
- may be used as the value of an **extends** clause of a class definition. Subclass constructors that intend to inherit the specified Date behaviour must include a **super** call to the Date constructor to create and initialize the subclass instance with a `[[DateValue]]` internal slot.
- has a "length" property whose value is 7.

### 21.4.2.1 Date ( ...values )

This function performs the following steps when called:

1. If *NewTarget* is **undefined**, then
  - a. Let *now* be the *time value* (UTC) identifying the current time.
  - b. Return `ToDateString(now)`.
2. Let *numberOfArgs* be the number of elements in *values*.
3. If *numberOfArgs* = 0, then
  - a. Let *dv* be the *time value* (UTC) identifying the current time.
4. Else if *numberOfArgs* = 1, then
  - a. Let *value* be *values*[0].
  - b. If *value* is an Object and *value* has a `[[DateValue]]` internal slot, then
    - i. Let *tv* be ! `thisTimeValue(value)`.
  - c. Else,
    - i. Let *v* be ? `ToPrimitive(value)`.
    - ii. If *v* is a String, then
      1. **Assert:** The next step never returns an **abrupt completion** because *v* is a String.
      2. Let *tv* be the result of parsing *v* as a date, in exactly the same manner as for the **parse** method (21.4.3.2).
    - iii. Else,
      1. Let *tv* be ? `ToNumber(v)`.
  - d. Let *dv* be `TimeClip(tv)`.

5. Else,
  - a. Assert: *numberOfArgs* ≥ 2.
  - b. Let *y* be ? *ToNumber*(*values*[0]).
  - c. Let *m* be ? *ToNumber*(*values*[1]).
  - d. If *numberOfArgs* > 2, let *dt* be ? *ToNumber*(*values*[2]); else let *dt* be 1<sub>F</sub>.
  - e. If *numberOfArgs* > 3, let *h* be ? *ToNumber*(*values*[3]); else let *h* be +0<sub>F</sub>.
  - f. If *numberOfArgs* > 4, let *min* be ? *ToNumber*(*values*[4]); else let *min* be +0<sub>F</sub>.
  - g. If *numberOfArgs* > 5, let *s* be ? *ToNumber*(*values*[5]); else let *s* be +0<sub>F</sub>.
  - h. If *numberOfArgs* > 6, let *milli* be ? *ToNumber*(*values*[6]); else let *milli* be +0<sub>F</sub>.
  - i. If *y* is NaN, let *yr* be NaN.
  - j. Else,
    - i. Let *yi* be ! *ToIntegerOrInfinity*(*y*).
    - ii. If 0 ≤ *yi* ≤ 99, let *yr* be 1900<sub>F</sub> + *F*(*yi*); otherwise, let *yr* be *y*.
  - k. Let *finalDate* be *MakeDate*(*MakeDay*(*yr*, *m*, *dt*), *MakeTime*(*h*, *min*, *s*, *milli*)).
  - l. Let *dv* be *TimeClip*(*UTC*(*finalDate*)).
6. Let *O* be ? *OrdinaryCreateFromConstructor*(*NewTarget*, "%Date.prototype%", « [[DateValue]] »).
7. Set *O*.[[DateValue]] to *dv*.
8. Return *O*.

### 21.4.3 Properties of the Date Constructor

The Date constructor:

- has a [[Prototype]] internal slot whose value is %Function.prototype%.
- has the following properties:

#### 21.4.3.1 Date.now ( )

This function returns the *time value* designating the UTC date and time of the occurrence of the call to it.

#### 21.4.3.2 Date.parse ( *string* )

This function applies the *ToString* operator to its argument. If *ToString* results in an *abrupt completion* the *Completion Record* is immediately returned. Otherwise, this function interprets the resulting String as a date and time; it returns a Number, the UTC *time value* corresponding to the date and time. The String may be interpreted as a local time, a UTC time, or a time in some other time zone, depending on the contents of the String. The function first attempts to parse the String according to the format described in Date Time String Format (21.4.1.18), including expanded years. If the String does not conform to that format the function may fall back to any implementation-specific heuristics or implementation-specific date formats. Strings that are unrecognizable or contain out-of-bounds format element values shall cause this function to return NaN.

If the String conforms to the *Date Time String Format*, substitute values take the place of absent format elements. When the **MM** or **DD** elements are absent, "01" is used. When the **HH**, **mm**, or **ss** elements are absent, "00" is used. When the **sss** element is absent, "000" is used. When the UTC offset representation is absent, date-only forms are interpreted as a UTC time and date-time forms are interpreted as a local time.

If *x* is any Date whose milliseconds amount is zero within a particular implementation of ECMAScript, then all of the following expressions should produce the same numeric value in that implementation, if all the properties referenced have their initial values:

```
x.valueOf()
Date.parse(x.toString())
Date.parse(x.toUTCString())
Date.parse(x.toISOString())
```

However, the expression

`Date.parse(x.toLocaleString())`

is not required to produce the same Number value as the preceding three expressions and, in general, the value produced by this function is [implementation-defined](#) when given any String value that does not conform to the Date Time String Format (21.4.1.18) and that could not be produced in that implementation by the `toString` or `toUTCString` method.

### 21.4.3.3 Date.prototype

The initial value of `Date.prototype` is the [Date prototype object](#).

This property has the attributes { `[[Writable]]: false`, `[[Enumerable]]: false`, `[[Configurable]]: false` }.

### 21.4.3.4 Date.UTC ( year [ , month [ , date [ , hours [ , minutes [ , seconds [ , ms ] ] ] ] ] ] )

This function performs the following steps when called:

1. Let *y* be ? [ToNumber](#)(*year*).
2. If *month* is present, let *m* be ? [ToNumber](#)(*month*); else let *m* be **+0**<sub>F</sub>.
3. If *date* is present, let *dt* be ? [ToNumber](#)(*date*); else let *dt* be **1**<sub>F</sub>.
4. If *hours* is present, let *h* be ? [ToNumber](#)(*hours*); else let *h* be **+0**<sub>F</sub>.
5. If *minutes* is present, let *min* be ? [ToNumber](#)(*minutes*); else let *min* be **+0**<sub>F</sub>.
6. If *seconds* is present, let *s* be ? [ToNumber](#)(*seconds*); else let *s* be **+0**<sub>F</sub>.
7. If *ms* is present, let *milli* be ? [ToNumber](#)(*ms*); else let *milli* be **+0**<sub>F</sub>.
8. If *y* is **NaN**, let *yr* be **NaN**.
9. Else,
  - a. Let *yi* be ! [ToIntegerOrInfinity](#)(*y*).
  - b. If  $0 \leq yi \leq 99$ , let *yr* be **1900**<sub>F</sub> +  $\mathbb{F}(yi)$ ; otherwise, let *yr* be *y*.
10. Return [TimeClip](#)([MakeDate](#)([MakeDay](#)(*yr*, *m*, *dt*), [MakeTime](#)(*h*, *min*, *s*, *milli*))).

The **"length"** property of this function is **7**<sub>F</sub>.

**NOTE** This function differs from the Date [constructor](#) in two ways: it returns a [time value](#) as a Number, rather than creating a Date, and it interprets the arguments in UTC rather than as local time.

### 21.4.4 Properties of the Date Prototype Object

The *Date prototype object*:

- is `%Date.prototype%`.
- is itself an [ordinary object](#).
- is not a Date instance and does not have a `[[DateValue]]` internal slot.
- has a `[[Prototype]]` internal slot whose value is `%Object.prototype%`.

Unless explicitly defined otherwise, the methods of the Date prototype object defined below are not generic and the **this** value passed to them must be an object that has a `[[DateValue]]` internal slot that has been initialized to a [time value](#).

The abstract operation *thisTimeValue* takes argument *value*. It performs the following steps when called:

1. If *value* is an Object and *value* has a `[[DateValue]]` internal slot, then
  - a. Return *value*.`[[DateValue]]`.
2. Throw a **TypeError** exception.

In following descriptions of functions that are properties of the Date prototype object, the phrase “*this Date object*” refers to the object that is the **this** value for the invocation of the function. If the Type of the **this** value is not Object, a **TypeError** exception is thrown. The phrase “*this time value*” within the specification of a method refers to the result returned by calling the abstract operation *thisTimeValue* with the **this** value of the method invocation passed as the argument.

#### 21.4.4.1 Date.prototype.constructor

The initial value of `Date.prototype.constructor` is `%Date%`.

#### 21.4.4.2 Date.prototype.getDate ( )

This method performs the following steps when called:

1. Let *t* be ? *thisTimeValue*(**this** value).
2. If *t* is **NaN**, return **NaN**.
3. Return `DateFromTime(LocalTime(t))`.

#### 21.4.4.3 Date.prototype.getDay ( )

This method performs the following steps when called:

1. Let *t* be ? *thisTimeValue*(**this** value).
2. If *t* is **NaN**, return **NaN**.
3. Return `WeekDay(LocalTime(t))`.

#### 21.4.4.4 Date.prototype.getFullYear ( )

This method performs the following steps when called:

1. Let *t* be ? *thisTimeValue*(**this** value).
2. If *t* is **NaN**, return **NaN**.
3. Return `YearFromTime(LocalTime(t))`.

#### 21.4.4.5 Date.prototype.getHours ( )

This method performs the following steps when called:

1. Let *t* be ? *thisTimeValue*(**this** value).
2. If *t* is **NaN**, return **NaN**.
3. Return `HourFromTime(LocalTime(t))`.

#### 21.4.4.6 Date.prototype.getMilliseconds ( )

This method performs the following steps when called:

1. Let  $t$  be ? `thisTimeValue(this value)`.
2. If  $t$  is **NaN**, return **NaN**.
3. Return `msFromTime(LocalTime( $t$ ))`.

#### 21.4.4.7 Date.prototype.getMinutes ( )

This method performs the following steps when called:

1. Let  $t$  be ? `thisTimeValue(this value)`.
2. If  $t$  is **NaN**, return **NaN**.
3. Return `MinFromTime(LocalTime( $t$ ))`.

#### 21.4.4.8 Date.prototype.getMonth ( )

This method performs the following steps when called:

1. Let  $t$  be ? `thisTimeValue(this value)`.
2. If  $t$  is **NaN**, return **NaN**.
3. Return `MonthFromTime(LocalTime( $t$ ))`.

#### 21.4.4.9 Date.prototype.getSeconds ( )

This method performs the following steps when called:

1. Let  $t$  be ? `thisTimeValue(this value)`.
2. If  $t$  is **NaN**, return **NaN**.
3. Return `SecFromTime(LocalTime( $t$ ))`.

#### 21.4.4.10 Date.prototype.getTime ( )

This method performs the following steps when called:

1. Return ? `thisTimeValue(this value)`.

#### 21.4.4.11 Date.prototype.getTimezoneOffset ( )

This method performs the following steps when called:

1. Let  $t$  be ? `thisTimeValue(this value)`.
2. If  $t$  is **NaN**, return **NaN**.
3. Return  $(t - \text{LocalTime}(t)) / \text{msPerMinute}$ .

#### 21.4.4.12 Date.prototype.getUTCDate ( )

This method performs the following steps when called:

1. Let  $t$  be ? `thisTimeValue(this value)`.
2. If  $t$  is **NaN**, return **NaN**.
3. Return `DateFromTime( $t$ )`.



#### 21.4.4.13 Date.prototype.getUTCDay ( )

This method performs the following steps when called:

1. Let *t* be ? [thisTimeValue](#)(**this** value).
2. If *t* is **NaN**, return **NaN**.
3. Return [WeekDay](#)(*t*).

#### 21.4.4.14 Date.prototype.getUTCFullYear ( )

This method performs the following steps when called:

1. Let *t* be ? [thisTimeValue](#)(**this** value).
2. If *t* is **NaN**, return **NaN**.
3. Return [YearFromTime](#)(*t*).

#### 21.4.4.15 Date.prototype.getUTCHours ( )

This method performs the following steps when called:

1. Let *t* be ? [thisTimeValue](#)(**this** value).
2. If *t* is **NaN**, return **NaN**.
3. Return [HourFromTime](#)(*t*).

#### 21.4.4.16 Date.prototype.getUTCMilliseconds ( )

This method performs the following steps when called:

1. Let *t* be ? [thisTimeValue](#)(**this** value).
2. If *t* is **NaN**, return **NaN**.
3. Return [msFromTime](#)(*t*).

#### 21.4.4.17 Date.prototype.getUTCMinutes ( )

This method performs the following steps when called:

1. Let *t* be ? [thisTimeValue](#)(**this** value).
2. If *t* is **NaN**, return **NaN**.
3. Return [MinFromTime](#)(*t*).

#### 21.4.4.18 Date.prototype.getUTCMonth ( )

This method performs the following steps when called:

1. Let *t* be ? [thisTimeValue](#)(**this** value).
2. If *t* is **NaN**, return **NaN**.
3. Return [MonthFromTime](#)(*t*).

#### 21.4.4.19 Date.prototype.getUTCSeconds ( )

This method performs the following steps when called:

1. Let *t* be ? [thisTimeValue](#)(**this** value).
2. If *t* is **NaN**, return **NaN**.
3. Return [SecFromTime](#)(*t*).

#### 21.4.4.20 Date.prototype.setDate ( *date* )

This method performs the following steps when called:

1. Let *t* be ? [thisTimeValue](#)(**this** value).
2. Let *dt* be ? [ToNumber](#)(*date*).
3. If *t* is **NaN**, return **NaN**.
4. Set *t* to [LocalTime](#)(*t*).
5. Let *newDate* be [MakeDate](#)([MakeDay](#)([YearFromTime](#)(*t*), [MonthFromTime](#)(*t*), *dt*), [TimeWithinDay](#)(*t*)).
6. Let *u* be [TimeClip](#)([UTC](#)(*newDate*)).
7. Set the [\[\[DateValue\]\]](#) internal slot of **this Date object** to *u*.
8. Return *u*.

#### 21.4.4.21 Date.prototype.setFullYear ( *year* [ , *month* [ , *date* ] ] )

This method performs the following steps when called:

1. Let *t* be ? [thisTimeValue](#)(**this** value).
2. Let *y* be ? [ToNumber](#)(*year*).
3. If *t* is **NaN**, set *t* to **+0**<sub>F</sub>; otherwise, set *t* to [LocalTime](#)(*t*).
4. If *month* is not present, let *m* be [MonthFromTime](#)(*t*); otherwise, let *m* be ? [ToNumber](#)(*month*).
5. If *date* is not present, let *dt* be [DateFromTime](#)(*t*); otherwise, let *dt* be ? [ToNumber](#)(*date*).
6. Let *newDate* be [MakeDate](#)([MakeDay](#)(*y*, *m*, *dt*), [TimeWithinDay](#)(*t*)).
7. Let *u* be [TimeClip](#)([UTC](#)(*newDate*)).
8. Set the [\[\[DateValue\]\]](#) internal slot of **this Date object** to *u*.
9. Return *u*.

The "**length**" property of this method is **3**<sub>F</sub>.

**NOTE** If *month* is not present, this method behaves as if *month* was present with the value [getMonth](#)(**this**). If *date* is not present, it behaves as if *date* was present with the value [getDate](#)(**this**).

#### 21.4.4.22 Date.prototype.setHours ( *hour* [ , *min* [ , *sec* [ , *ms* ] ] ] )

This method performs the following steps when called:

1. Let *t* be ? [thisTimeValue](#)(**this** value).
2. Let *h* be ? [ToNumber](#)(*hour*).
3. If *min* is present, let *m* be ? [ToNumber](#)(*min*).
4. If *sec* is present, let *s* be ? [ToNumber](#)(*sec*).
5. If *ms* is present, let *milli* be ? [ToNumber](#)(*ms*).
6. If *t* is **NaN**, return **NaN**.

7. Set *t* to `LocalTime(t)`.
8. If *min* is not present, let *m* be `MinFromTime(t)`.
9. If *sec* is not present, let *s* be `SecFromTime(t)`.
10. If *ms* is not present, let *milli* be `msFromTime(t)`.
11. Let *date* be `MakeDate(Day(t), MakeTime(h, m, s, milli))`.
12. Let *u* be `TimeClip(UTC(date))`.
13. Set the `[[DateValue]]` internal slot of `this Date object` to *u*.
14. Return *u*.

The **"length"** property of this method is 4<sub>F</sub>.

**NOTE** If *min* is not present, this method behaves as if *min* was present with the value `getMinutes()`. If *sec* is not present, it behaves as if *sec* was present with the value `getSeconds()`. If *ms* is not present, it behaves as if *ms* was present with the value `getMilliseconds()`.

#### 21.4.4.23 `Date.prototype.setMilliseconds ( ms )`

This method performs the following steps when called:

1. Let *t* be ? `thisTimeValue(this value)`.
2. Set *ms* to ? `ToNumber(ms)`.
3. If *t* is **NaN**, return **NaN**.
4. Set *t* to `LocalTime(t)`.
5. Let *time* be `MakeTime(HourFromTime(t), MinFromTime(t), SecFromTime(t), ms)`.
6. Let *u* be `TimeClip(UTC(MakeDate(Day(t), time)))`.
7. Set the `[[DateValue]]` internal slot of `this Date object` to *u*.
8. Return *u*.

#### 21.4.4.24 `Date.prototype.setMinutes ( min [ , sec [ , ms ] ] )`

This method performs the following steps when called:

1. Let *t* be ? `thisTimeValue(this value)`.
2. Let *m* be ? `ToNumber(min)`.
3. If *sec* is present, let *s* be ? `ToNumber(sec)`.
4. If *ms* is present, let *milli* be ? `ToNumber(ms)`.
5. If *t* is **NaN**, return **NaN**.
6. Set *t* to `LocalTime(t)`.
7. If *sec* is not present, let *s* be `SecFromTime(t)`.
8. If *ms* is not present, let *milli* be `msFromTime(t)`.
9. Let *date* be `MakeDate(Day(t), MakeTime(HourFromTime(t), m, s, milli))`.
10. Let *u* be `TimeClip(UTC(date))`.
11. Set the `[[DateValue]]` internal slot of `this Date object` to *u*.
12. Return *u*.

The **"length"** property of this method is 3<sub>F</sub>.

**NOTE** If *sec* is not present, this method behaves as if *sec* was present with the value `getSeconds()`. If *ms* is not present, this behaves as if *ms* was present with the value `getMilliseconds()`.

#### 21.4.4.25 Date.prototype.setMonth ( *month* [ , *date* ] )

This method performs the following steps when called:

1. Let *t* be ? [thisTimeValue](#)(**this** value).
2. Let *m* be ? [ToNumber](#)(*month*).
3. If *date* is present, let *dt* be ? [ToNumber](#)(*date*).
4. If *t* is **NaN**, return **NaN**.
5. Set *t* to [LocalTime](#)(*t*).
6. If *date* is not present, let *dt* be [DateFromTime](#)(*t*).
7. Let *newDate* be [MakeDate](#)([MakeDay](#)([YearFromTime](#)(*t*), *m*, *dt*), [TimeWithinDay](#)(*t*)).
8. Let *u* be [TimeClip](#)([UTC](#)(*newDate*)).
9. Set the [\[\[DateValue\]\]](#) internal slot of **this Date object** to *u*.
10. Return *u*.

The "**length**" property of this method is 2<sub>F</sub>.

**NOTE** If *date* is not present, this method behaves as if *date* was present with the value [getDate](#)(**C**).

#### 21.4.4.26 Date.prototype.setSeconds ( *sec* [ , *ms* ] )

This method performs the following steps when called:

1. Let *t* be ? [thisTimeValue](#)(**this** value).
2. Let *s* be ? [ToNumber](#)(*sec*).
3. If *ms* is present, let *milli* be ? [ToNumber](#)(*ms*).
4. If *t* is **NaN**, return **NaN**.
5. Set *t* to [LocalTime](#)(*t*).
6. If *ms* is not present, let *milli* be [msFromTime](#)(*t*).
7. Let *date* be [MakeDate](#)([Day](#)(*t*), [MakeTime](#)([HourFromTime](#)(*t*), [MinFromTime](#)(*t*), *s*, *milli*)).
8. Let *u* be [TimeClip](#)([UTC](#)(*date*)).
9. Set the [\[\[DateValue\]\]](#) internal slot of **this Date object** to *u*.
10. Return *u*.

The "**length**" property of this method is 2<sub>F</sub>.

**NOTE** If *ms* is not present, this method behaves as if *ms* was present with the value [getMilliseconds](#)(**C**).

#### 21.4.4.27 Date.prototype.setTime ( *time* )

This method performs the following steps when called:

1. Perform ? [thisTimeValue](#)(**this** value).
2. Let *t* be ? [ToNumber](#)(*time*).
3. Let *v* be [TimeClip](#)(*t*).
4. Set the [\[\[DateValue\]\]](#) internal slot of **this Date object** to *v*.
5. Return *v*.

#### 21.4.4.28 Date.prototype.setUTCDate ( *date* )

This method performs the following steps when called:

1. Let *t* be ? [thisTimeValue](#)(**this** value).
2. Let *dt* be ? [ToNumber](#)(*date*).
3. If *t* is **NaN**, return **NaN**.
4. Let *newDate* be [MakeDate](#)([MakeDay](#)([YearFromTime](#)(*t*), [MonthFromTime](#)(*t*), *dt*), [TimeWithinDay](#)(*t*)).
5. Let *v* be [TimeClip](#)(*newDate*).
6. Set the [[DateValue]] internal slot of **this Date object** to *v*.
7. Return *v*.

#### 21.4.4.29 Date.prototype.setUTCFullYear ( *year* [ , *month* [ , *date* ] ] )

This method performs the following steps when called:

1. Let *t* be ? [thisTimeValue](#)(**this** value).
2. If *t* is **NaN**, set *t* to **+0**<sub>F</sub>.
3. Let *y* be ? [ToNumber](#)(*year*).
4. If *month* is not present, let *m* be [MonthFromTime](#)(*t*); otherwise, let *m* be ? [ToNumber](#)(*month*).
5. If *date* is not present, let *dt* be [DateFromTime](#)(*t*); otherwise, let *dt* be ? [ToNumber](#)(*date*).
6. Let *newDate* be [MakeDate](#)([MakeDay](#)(*y*, *m*, *dt*), [TimeWithinDay](#)(*t*)).
7. Let *v* be [TimeClip](#)(*newDate*).
8. Set the [[DateValue]] internal slot of **this Date object** to *v*.
9. Return *v*.

The "**length**" property of this method is **3**<sub>F</sub>.

**NOTE** If *month* is not present, this method behaves as if *month* was present with the value [getUTCMonth](#)(**0**). If *date* is not present, it behaves as if *date* was present with the value [getUTCDate](#)(**0**).

#### 21.4.4.30 Date.prototype.setUTCHours ( *hour* [ , *min* [ , *sec* [ , *ms* ] ] ] )

This method performs the following steps when called:

1. Let *t* be ? [thisTimeValue](#)(**this** value).
2. Let *h* be ? [ToNumber](#)(*hour*).
3. If *min* is present, let *m* be ? [ToNumber](#)(*min*).
4. If *sec* is present, let *s* be ? [ToNumber](#)(*sec*).
5. If *ms* is present, let *milli* be ? [ToNumber](#)(*ms*).
6. If *t* is **NaN**, return **NaN**.
7. If *min* is not present, let *m* be [MinFromTime](#)(*t*).
8. If *sec* is not present, let *s* be [SecFromTime](#)(*t*).
9. If *ms* is not present, let *milli* be [msFromTime](#)(*t*).
10. Let *date* be [MakeDate](#)([Day](#)(*t*), [MakeTime](#)(*h*, *m*, *s*, *milli*)).
11. Let *v* be [TimeClip](#)(*date*).
12. Set the [[DateValue]] internal slot of **this Date object** to *v*.
13. Return *v*.

The "length" property of this method is 4<sub>F</sub>.

**NOTE** If *min* is not present, this method behaves as if *min* was present with the value `getUTCMinutes()`. If *sec* is not present, it behaves as if *sec* was present with the value `getUTCSeconds()`. If *ms* is not present, it behaves as if *ms* was present with the value `getUTCMilliseconds()`.

#### 21.4.4.31 Date.prototype.setUTCMilliseconds ( *ms* )

This method performs the following steps when called:

1. Let *t* be ? `thisTimeValue(this value)`.
2. Set *ms* to ? `ToNumber(ms)`.
3. If *t* is **NaN**, return **NaN**.
4. Let *time* be `MakeTime(HourFromTime(t), MinFromTime(t), SecFromTime(t), ms)`.
5. Let *v* be `TimeClip(MakeDate(Day(t), time))`.
6. Set the [[DateValue]] internal slot of this Date object to *v*.
7. Return *v*.

#### 21.4.4.32 Date.prototype.setUTCMinutes ( *min* [ , *sec* [ , *ms* ] ] )

This method performs the following steps when called:

1. Let *t* be ? `thisTimeValue(this value)`.
2. Let *m* be ? `ToNumber(min)`.
3. If *sec* is present, let *s* be ? `ToNumber(sec)`.
4. If *ms* is present, let *milli* be ? `ToNumber(ms)`.
5. If *t* is **NaN**, return **NaN**.
6. If *sec* is not present, let *s* be `SecFromTime(t)`.
7. If *ms* is not present, let *milli* be `msFromTime(t)`.
8. Let *date* be `MakeDate(Day(t), MakeTime(HourFromTime(t), m, s, milli))`.
9. Let *v* be `TimeClip(date)`.
10. Set the [[DateValue]] internal slot of this Date object to *v*.
11. Return *v*.

The "length" property of this method is 3<sub>F</sub>.

**NOTE** If *sec* is not present, this method behaves as if *sec* was present with the value `getUTCSeconds()`. If *ms* is not present, it behaves as if *ms* was present with the value return by `getUTCMilliseconds()`.

#### 21.4.4.33 Date.prototype.setUTCMonth ( *month* [ , *date* ] )

This method performs the following steps when called:

1. Let *t* be ? `thisTimeValue(this value)`.
2. Let *m* be ? `ToNumber(month)`.
3. If *date* is present, let *dt* be ? `ToNumber(date)`.
4. If *t* is **NaN**, return **NaN**.
5. If *date* is not present, let *dt* be `DateFromTime(t)`.

6. Let *newDate* be `MakeDate(MakeDay(YearFromTime(t), m, dt), TimeWithinDay(t))`.
7. Let *v* be `TimeClip(newDate)`.
8. Set the `[[DateValue]]` internal slot of this Date object to *v*.
9. Return *v*.

The **"length"** property of this method is 2<sub>F</sub>.

NOTE If *date* is not present, this method behaves as if *date* was present with the value `getUTCDate()`.

#### 21.4.4.34 `Date.prototype.setUTCSeconds ( sec [ , ms ] )`

This method performs the following steps when called:

1. Let *t* be ? `thisTimeValue(this value)`.
2. Let *s* be ? `ToNumber(sec)`.
3. If *ms* is present, let *milli* be ? `ToNumber(ms)`.
4. If *t* is **NaN**, return **NaN**.
5. If *ms* is not present, let *milli* be `msFromTime(t)`.
6. Let *date* be `MakeDate(Day(t), MakeTime(HourFromTime(t), MinFromTime(t), s, milli))`.
7. Let *v* be `TimeClip(date)`.
8. Set the `[[DateValue]]` internal slot of this Date object to *v*.
9. Return *v*.

The **"length"** property of this method is 2<sub>F</sub>.

NOTE If *ms* is not present, this method behaves as if *ms* was present with the value `getUTCMilliseconds()`.

#### 21.4.4.35 `Date.prototype.toString ( )`

This method performs the following steps when called:

1. Let *O* be this Date object.
2. Let *tv* be ? `thisTimeValue(O)`.
3. If *tv* is **NaN**, return **"Invalid Date"**.
4. Let *t* be `LocalTime(tv)`.
5. Return `DateString(t)`.

#### 21.4.4.36 `Date.prototype.toISOString ( )`

If this time value is not a finite Number or if it corresponds with a year that cannot be represented in the [Date Time String Format](#), this method throws a **RangeError** exception. Otherwise, it returns a String representation of this time value in that format on the UTC time scale, including all format elements and the UTC offset representation **"Z"**.

#### 21.4.4.37 `Date.prototype.toJSON ( key )`

This method provides a String representation of a Date for use by `JSON.stringify` (25.5.2).

It performs the following steps when called:

1. Let *O* be ? `ToObject(this value)`.
2. Let *tv* be ? `ToPrimitive(O, number)`.
3. If *tv* is a `Number` and *tv* is not `finite`, return `null`.
4. Return ? `Invoke(O, "toISOString")`.

NOTE 1 The argument is ignored.

NOTE 2 This method is intentionally generic; it does not require that its `this` value be a `Date`. Therefore, it can be transferred to other kinds of objects for use as a method. However, it does require that any such object have a `toISOString` method.

#### 21.4.4.38 `Date.prototype.toLocaleDateString` ( [ *reserved1* [ , *reserved2* ] ] )

An ECMAScript implementation that includes the ECMA-402 Internationalization API must implement this method as specified in the ECMA-402 specification. If an ECMAScript implementation does not include the ECMA-402 API the following specification of this method is used:

This method returns a `String` value. The contents of the `String` are [implementation-defined](#), but are intended to represent the “date” portion of the `Date` in the current time zone in a convenient, human-readable form that corresponds to the conventions of the [host environment](#)'s current locale.

The meaning of the optional parameters to this method are defined in the ECMA-402 specification; implementations that do not include ECMA-402 support must not use those parameter positions for anything else.

#### 21.4.4.39 `Date.prototype.toLocaleString` ( [ *reserved1* [ , *reserved2* ] ] )

An ECMAScript implementation that includes the ECMA-402 Internationalization API must implement this method as specified in the ECMA-402 specification. If an ECMAScript implementation does not include the ECMA-402 API the following specification of this method is used:

This method returns a `String` value. The contents of the `String` are [implementation-defined](#), but are intended to represent the `Date` in the current time zone in a convenient, human-readable form that corresponds to the conventions of the [host environment](#)'s current locale.

The meaning of the optional parameters to this method are defined in the ECMA-402 specification; implementations that do not include ECMA-402 support must not use those parameter positions for anything else.

#### 21.4.4.40 `Date.prototype.toLocaleTimeString` ( [ *reserved1* [ , *reserved2* ] ] )

An ECMAScript implementation that includes the ECMA-402 Internationalization API must implement this method as specified in the ECMA-402 specification. If an ECMAScript implementation does not include the ECMA-402 API the following specification of this method is used:

This method returns a `String` value. The contents of the `String` are [implementation-defined](#), but are intended to represent the “time” portion of the `Date` in the current time zone in a convenient, human-readable form that corresponds to the conventions of the [host environment](#)'s current locale.

The meaning of the optional parameters to this method are defined in the ECMA-402 specification; implementations that do not include ECMA-402 support must not use those parameter positions for anything else.



#### 21.4.4.41 Date.prototype.toString ( )

This method performs the following steps when called:

1. Let *tv* be ? `thisTimeValue(this value)`.
2. Return `ToDateString(tv)`.

NOTE 1 For any Date *d* such that *d*.`[[DateValue]]` is evenly divisible by 1000, the result of `Date.parse(d.toString()) = d.valueOf()`. See 21.4.3.2.

NOTE 2 This method is not generic; it throws a **TypeError** exception if its **this** value is not a Date. Therefore, it cannot be transferred to other kinds of objects for use as a method.

##### 21.4.4.41.1 TimeString ( *tv* )

The abstract operation TimeString takes argument *tv* (a Number, but not **NaN**) and returns a String. It performs the following steps when called:

1. Let *hour* be `ToZeroPaddedDecimalString( $\mathbb{R}(\text{HourFromTime}(tv))$ , 2)`.
2. Let *minute* be `ToZeroPaddedDecimalString( $\mathbb{R}(\text{MinFromTime}(tv))$ , 2)`.
3. Let *second* be `ToZeroPaddedDecimalString( $\mathbb{R}(\text{SecFromTime}(tv))$ , 2)`.
4. Return the string-concatenation of *hour*, ":", *minute*, ":", *second*, the code unit 0x0020 (SPACE), and "GMT".

##### 21.4.4.41.2 DateString ( *tv* )

The abstract operation DateString takes argument *tv* (a Number, but not **NaN**) and returns a String. It performs the following steps when called:

1. Let *weekday* be the Name of the entry in Table 61 with the Number `WeekDay(tv)`.
2. Let *month* be the Name of the entry in Table 62 with the Number `MonthFromTime(tv)`.
3. Let *day* be `ToZeroPaddedDecimalString( $\mathbb{R}(\text{DateFromTime}(tv))$ , 2)`.
4. Let *yv* be `YearFromTime(tv)`.
5. If *yv* is `+0F` or *yv* > `+0F`, let *yearSign* be the empty String; otherwise, let *yearSign* be "-".
6. Let *paddedYear* be `ToZeroPaddedDecimalString(abs( $\mathbb{R}(yv)$ ), 4)`.
7. Return the string-concatenation of *weekday*, the code unit 0x0020 (SPACE), *month*, the code unit 0x0020 (SPACE), *day*, the code unit 0x0020 (SPACE), *yearSign*, and *paddedYear*.

Table 61: Names of days of the week

Number	Name
+0 <sub>F</sub>	"Sun"
1 <sub>F</sub>	"Mon"
2 <sub>F</sub>	"Tue"
3 <sub>F</sub>	"Wed"
4 <sub>F</sub>	"Thu"
5 <sub>F</sub>	"Fri"
6 <sub>F</sub>	"Sat"

Table 62: Names of months of the year

Number	Name
+0 <sub>F</sub>	"Jan"
1 <sub>F</sub>	"Feb"
2 <sub>F</sub>	"Mar"
3 <sub>F</sub>	"Apr"
4 <sub>F</sub>	"May"
5 <sub>F</sub>	"Jun"
6 <sub>F</sub>	"Jul"
7 <sub>F</sub>	"Aug"
8 <sub>F</sub>	"Sep"
9 <sub>F</sub>	"Oct"
10 <sub>F</sub>	"Nov"
11 <sub>F</sub>	"Dec"

#### 21.4.4.41.3 TimeZoneString ( *tv* )

The abstract operation TimeZoneString takes argument *tv* (an [integral Number](#)) and returns a String. It performs the following steps when called:

1. Let *localTimeZone* be [DefaultTimeZone\(\)](#).
2. If [IsTimeZoneOffsetString\(localTimeZone\)](#) is **true**, then
  - a. Let *offsetNs* be [ParseTimeZoneOffsetString\(localTimeZone\)](#).
3. Else,

- a. Let *offsetNs* be `GetNamedTimeZoneOffsetNanoseconds(localTimeZone,  $\mathbb{Z}(\mathbb{R}(tv) \times 10^6)$ )`.
4. Let *offset* be  `$\mathbb{F}(\text{truncate}(\text{offsetNs} / 10^6))$` .
5. If *offset* is  `$+0_{\mathbb{F}}$`  or *offset* >  `$+0_{\mathbb{F}}$` , then
  - a. Let *offsetSign* be `"+"`.
  - b. Let *absOffset* be *offset*.
6. Else,
  - a. Let *offsetSign* be `"-"`.
  - b. Let *absOffset* be  `$-offset$` .
7. Let *offsetMin* be `ToZeroPaddedDecimalString( $\mathbb{R}(\text{MinFromTime}(\text{absOffset}))$ , 2)`.
8. Let *offsetHour* be `ToZeroPaddedDecimalString( $\mathbb{R}(\text{HourFromTime}(\text{absOffset}))$ , 2)`.
9. Let *tzName* be an **implementation-defined** string that is either the empty String or the **string-concatenation** of the code unit 0x0020 (SPACE), the code unit 0x0028 (LEFT PARENTHESIS), an **implementation-defined** timezone name, and the code unit 0x0029 (RIGHT PARENTHESIS).
10. Return the **string-concatenation** of *offsetSign*, *offsetHour*, *offsetMin*, and *tzName*.

#### 21.4.4.41.4 ToDateString ( tv )

The abstract operation ToDateString takes argument *tv* (an **integral Number** or **NaN**) and returns a String. It performs the following steps when called:

1. If *tv* is **NaN**, return **"Invalid Date"**.
2. Let *t* be `LocalTime(tv)`.
3. Return the **string-concatenation** of `DateString(t)`, the code unit 0x0020 (SPACE), `TimeString(t)`, and `TimeZoneString(tv)`.

#### 21.4.4.42 Date.prototype.toTimeString ( )

This method performs the following steps when called:

1. Let *O* be **this Date object**.
2. Let *tv* be ? `thisTimeValue(O)`.
3. If *tv* is **NaN**, return **"Invalid Date"**.
4. Let *t* be `LocalTime(tv)`.
5. Return the **string-concatenation** of `TimeString(t)` and `TimeZoneString(tv)`.

#### 21.4.4.43 Date.prototype.toUTCString ( )

This method returns a String value representing the instance in time corresponding to **this time value**. The format of the String is based upon "HTTP-date" from RFC 7231, generalized to support the full range of times supported by ECMAScript Dates.

It performs the following steps when called:

1. Let *O* be **this Date object**.
2. Let *tv* be ? `thisTimeValue(O)`.
3. If *tv* is **NaN**, return **"Invalid Date"**.
4. Let *weekday* be the Name of the entry in [Table 61](#) with the Number `WeekDay(tv)`.
5. Let *month* be the Name of the entry in [Table 62](#) with the Number `MonthFromTime(tv)`.
6. Let *day* be `ToZeroPaddedDecimalString( $\mathbb{R}(\text{DateFromTime}(tv))$ , 2)`.
7. Let *yv* be `YearFromTime(tv)`.
8. If *yv* is  `$+0_{\mathbb{F}}$`  or *yv* >  `$+0_{\mathbb{F}}$` , let *yearSign* be the empty String; otherwise, let *yearSign* be `"-"`.
9. Let *paddedYear* be `ToZeroPaddedDecimalString(abs( $\mathbb{R}(yv)$ ), 4)`.

10. Return the [string-concatenation](#) of *weekday*, ",", the code unit 0x0020 (SPACE), *day*, the code unit 0x0020 (SPACE), *month*, the code unit 0x0020 (SPACE), *yearSign*, *paddedYear*, the code unit 0x0020 (SPACE), and [TimeString](#)(*tv*).

#### 21.4.4.44 Date.prototype.valueOf ( )

This method performs the following steps when called:

1. Return ? [thisTimeValue](#)(**this** value).

#### 21.4.4.45 Date.prototype [ @@toPrimitive ] ( *hint* )

This method is called by ECMAScript language operators to convert a Date to a primitive value. The allowed values for *hint* are "default", "number", and "string". Dates are unique among built-in ECMAScript object in that they treat "default" as being equivalent to "string", All other built-in ECMAScript objects treat "default" as being equivalent to "number".

It performs the following steps when called:

1. Let *O* be the **this** value.
2. If *O* is not an Object, throw a **TypeError** exception.
3. If *hint* is either "string" or "default", then
  - a. Let *tryFirst* be string.
4. Else if *hint* is "number", then
  - a. Let *tryFirst* be number.
5. Else, throw a **TypeError** exception.
6. Return ? [OrdinaryToPrimitive](#)(*O*, *tryFirst*).

This property has the attributes { [[Writable]]: **false**, [[Enumerable]]: **false**, [[Configurable]]: **true** }.

The value of the "name" property of this method is "[Symbol.toPrimitive]".

### 21.4.5 Properties of Date Instances

Date instances are [ordinary objects](#) that inherit properties from the [Date prototype object](#). Date instances also have a [[DateValue]] internal slot. The [[DateValue]] internal slot is the [time value](#) represented by this Date.

## 22 Text Processing

### 22.1 String Objects

#### 22.1.1 The String Constructor

The String [constructor](#):

- is %String%.
- is the initial value of the "String" property of the [global object](#).
- creates and initializes a new String object when called as a [constructor](#).
- performs a type conversion when called as a function rather than as a [constructor](#).

- may be used as the value of an **extends** clause of a class definition. Subclass **constructors** that intend to inherit the specified String behaviour must include a **super** call to the String **constructor** to create and initialize the subclass instance with a `[[StringData]]` internal slot.

### 22.1.1.1 String ( *value* )

This function performs the following steps when called:

1. If *value* is not present, let *s* be the empty String.
2. Else,
  - a. If NewTarget is **undefined** and *value* is a Symbol, return `SymbolDescriptiveString(value)`.
  - b. Let *s* be `? ToString(value)`.
3. If NewTarget is **undefined**, return *s*.
4. Return `StringCreate(s, ? GetPrototypeFromConstructor(NewTarget, "%String.prototype%"))`.

### 22.1.2 Properties of the String Constructor

The String **constructor**:

- has a `[[Prototype]]` internal slot whose value is `%Function.prototype%`.
- has the following properties:

#### 22.1.2.1 String.fromCharCode ( ...*codeUnits* )

This function may be called with any number of arguments which form the rest parameter *codeUnits*.

It performs the following steps when called:

1. Let *result* be the empty String.
2. For each element *next* of *codeUnits*, do
  - a. Let *nextCU* be the code unit whose numeric value is  $\mathbb{R}(? ToUint16(next))$ .
  - b. Set *result* to the **string-concatenation** of *result* and *nextCU*.
3. Return *result*.

The **"length"** property of this function is  $1_{\mathbb{F}}$ .

#### 22.1.2.2 String.fromCodePoint ( ...*codePoints* )

This function may be called with any number of arguments which form the rest parameter *codePoints*.

It performs the following steps when called:

1. Let *result* be the empty String.
2. For each element *next* of *codePoints*, do
  - a. Let *nextCP* be `? ToNumber(next)`.
  - b. If `IsIntegralNumber(nextCP)` is **false**, throw a **RangeError** exception.
  - c. If  $\mathbb{R}(nextCP) < 0$  or  $\mathbb{R}(nextCP) > 0x10FFFF$ , throw a **RangeError** exception.
  - d. Set *result* to the **string-concatenation** of *result* and `UTF16EncodeCodePoint( $\mathbb{R}(nextCP)$ )`.
3. **Assert**: If *codePoints* is empty, then *result* is the empty String.
4. Return *result*.

The **"length"** property of this function is  $1_{\mathbb{F}}$ .

### 22.1.2.3 String.prototype

The initial value of `String.prototype` is the [String prototype object](#).

This property has the attributes { `[[Writable]]`: **false**, `[[Enumerable]]`: **false**, `[[Configurable]]`: **false** }.

### 22.1.2.4 String.raw ( *template*, ...*substitutions* )

This function may be called with a variable number of arguments. The first argument is *template* and the remainder of the arguments form the [List substitutions](#).

It performs the following steps when called:

1. Let *substitutionCount* be the number of elements in *substitutions*.
2. Let *cooked* be ? `ToObject(template)`.
3. Let *literals* be ? `ToObject(? Get(cooked, "raw"))`.
4. Let *literalCount* be ? `LengthOfArrayLike(literals)`.
5. If *literalCount* ≤ 0, return the empty String.
6. Let *R* be the empty String.
7. Let *nextIndex* be 0.
8. Repeat,
  - a. Let *nextLiteralVal* be ? `Get(literals, ! ToString(If(nextIndex)))`.
  - b. Let *nextLiteral* be ? `ToString(nextLiteralVal)`.
  - c. Set *R* to the [string-concatenation](#) of *R* and *nextLiteral*.
  - d. If *nextIndex* + 1 = *literalCount*, return *R*.
  - e. If *nextIndex* < *substitutionCount*, then
    - i. Let *nextSubVal* be *substitutions*[*nextIndex*].
    - ii. Let *nextSub* be ? `ToString(nextSubVal)`.
    - iii. Set *R* to the [string-concatenation](#) of *R* and *nextSub*.
  - f. Set *nextIndex* to *nextIndex* + 1.

**NOTE** This function is intended for use as a tag function of a Tagged Template ([13.3.11](#)). When called as such, the first argument will be a well formed template object and the rest parameter will contain the substitution values.

### 22.1.3 Properties of the String Prototype Object

The *String prototype object*:

- is `%String.prototype%`.
- is a [String exotic object](#) and has the internal methods specified for such objects.
- has a `[[StringData]]` internal slot whose value is the empty String.
- has a **"length"** property whose initial value is **+0<sub>F</sub>** and whose attributes are { `[[Writable]]`: **false**, `[[Enumerable]]`: **false**, `[[Configurable]]`: **false** }.
- has a `[[Prototype]]` internal slot whose value is `%Object.prototype%`.

Unless explicitly stated otherwise, the methods of the String prototype object defined below are not generic and the **this** value passed to them must be either a String value or an object that has a `[[StringData]]` internal slot that has been initialized to a String value.

The abstract operation *thisStringValue* takes argument *value*. It performs the following steps when called:

1. If *value* is a String, return *value*.
2. If *value* is an Object and *value* has a `[[StringData]]` internal slot, then
  - a. Let *s* be *value*.`[[StringData]]`.
  - b. Assert: *s* is a String.
  - c. Return *s*.
3. Throw a **TypeError** exception.

### 22.1.3.1 String.prototype.at ( *index* )

1. Let *O* be ? `RequireObjectCoercible(this value)`.
2. Let *S* be ? `ToString(O)`.
3. Let *len* be the length of *S*.
4. Let *relativeIndex* be ? `ToIntegerOrInfinity(index)`.
5. If *relativeIndex*  $\geq 0$ , then
  - a. Let *k* be *relativeIndex*.
6. Else,
  - a. Let *k* be *len* + *relativeIndex*.
7. If *k*  $< 0$  or *k*  $\geq len$ , return **undefined**.
8. Return the `substring` of *S* from *k* to *k* + 1.

### 22.1.3.2 String.prototype.charAt ( *pos* )

NOTE 1 This method returns a single element String containing the code unit at index *pos* within the String value resulting from converting this object to a String. If there is no element at that index, the result is the empty String. The result is a String value, not a String object.

If *pos* is an `integral Number`, then the result of `x.charAt(pos)` is equivalent to the result of `x.substring(pos, pos + 1)`.

This method performs the following steps when called:

1. Let *O* be ? `RequireObjectCoercible(this value)`.
2. Let *S* be ? `ToString(O)`.
3. Let *position* be ? `ToIntegerOrInfinity(pos)`.
4. Let *size* be the length of *S*.
5. If *position*  $< 0$  or *position*  $\geq size$ , return the empty String.
6. Return the `substring` of *S* from *position* to *position* + 1.

NOTE 2 This method is intentionally generic; it does not require that its **this** value be a String object. Therefore, it can be transferred to other kinds of objects for use as a method.

### 22.1.3.3 String.prototype.charCodeAt ( *pos* )

NOTE 1 This method returns a Number (a non-negative `integral Number` less than  $2^{16}$ ) that is the numeric value of the code unit at index *pos* within the String resulting from converting this object to a String. If there is no element at that index, the result is **NaN**.

This method performs the following steps when called:

1. Let *O* be ? `RequireObjectCoercible(this value)`.

2. Let *S* be ? ToString(*O*).
3. Let *position* be ? ToIntegerOrInfinity(*pos*).
4. Let *size* be the length of *S*.
5. If *position* < 0 or *position* ≥ *size*, return NaN.
6. Return the Number value for the numeric value of the code unit at index *position* within the String *S*.

NOTE 2 This method is intentionally generic; it does not require that its **this** value be a String object. Therefore it can be transferred to other kinds of objects for use as a method.

#### 22.1.3.4 String.prototype.codePointAt ( *pos* )

NOTE 1 This method returns a non-negative integral Number less than or equal to 0x10FFFF<sub>F</sub> that is the numeric value of the UTF-16 encoded code point (6.1.4) starting at the string element at index *pos* within the String resulting from converting this object to a String. If there is no element at that index, the result is **undefined**. If a valid UTF-16 surrogate pair does not begin at *pos*, the result is the code unit at *pos*.

This method performs the following steps when called:

1. Let *O* be ? RequireObjectCoercible(**this** value).
2. Let *S* be ? ToString(*O*).
3. Let *position* be ? ToIntegerOrInfinity(*pos*).
4. Let *size* be the length of *S*.
5. If *position* < 0 or *position* ≥ *size*, return **undefined**.
6. Let *cp* be CodePointAt(*S*, *position*).
7. Return  $\mathbb{F}(cp.[[CodePoint]])$ .

NOTE 2 This method is intentionally generic; it does not require that its **this** value be a String object. Therefore it can be transferred to other kinds of objects for use as a method.

#### 22.1.3.5 String.prototype.concat ( ...*args* )

NOTE 1 When this method is called it returns the String value consisting of the code units of the **this** value (converted to a String) followed by the code units of each of the arguments converted to a String. The result is a String value, not a String object.

This method performs the following steps when called:

1. Let *O* be ? RequireObjectCoercible(**this** value).
2. Let *S* be ? ToString(*O*).
3. Let *R* be *S*.
4. For each element *next* of *args*, do
  - a. Let *nextString* be ? ToString(*next*).
  - b. Set *R* to the string-concatenation of *R* and *nextString*.
5. Return *R*.

The "length" property of this method is 1<sub>F</sub>.

NOTE 2 This method is intentionally generic; it does not require that its **this** value be a String object. Therefore it can be transferred to other kinds of objects for use as a method.



### 22.1.3.6 String.prototype.constructor

The initial value of `String.prototype.constructor` is `%String%`.

### 22.1.3.7 String.prototype.endsWith ( *searchString* [ , *endPosition* ] )

This method performs the following steps when called:

1. Let *O* be ? `RequireObjectCoercible(this value)`.
2. Let *S* be ? `ToString(O)`.
3. Let *isRegExp* be ? `IsRegExp(searchString)`.
4. If *isRegExp* is **true**, throw a **TypeError** exception.
5. Let *searchStr* be ? `ToString(searchString)`.
6. Let *len* be the length of *S*.
7. If *endPosition* is **undefined**, let *pos* be *len*; else let *pos* be ? `ToIntegerOrInfinity(endPosition)`.
8. Let *end* be the result of `clamping pos` between 0 and *len*.
9. Let *searchLength* be the length of *searchStr*.
10. If *searchLength* = 0, return **true**.
11. Let *start* be *end* - *searchLength*.
12. If *start* < 0, return **false**.
13. Let *substring* be the `substring` of *S* from *start* to *end*.
14. If *substring* is *searchStr*, return **true**.
15. Return **false**.

NOTE 1 This method returns **true** if the sequence of code units of *searchString* converted to a String is the same as the corresponding code units of this object (converted to a String) starting at *endPosition* - `length(this)`. Otherwise it returns **false**.

NOTE 2 Throwing an exception if the first argument is a RegExp is specified in order to allow future editions to define extensions that allow such argument values.

NOTE 3 This method is intentionally generic; it does not require that its **this** value be a String object. Therefore, it can be transferred to other kinds of objects for use as a method.

### 22.1.3.8 String.prototype.includes ( *searchString* [ , *position* ] )

This method performs the following steps when called:

1. Let *O* be ? `RequireObjectCoercible(this value)`.
2. Let *S* be ? `ToString(O)`.
3. Let *isRegExp* be ? `IsRegExp(searchString)`.
4. If *isRegExp* is **true**, throw a **TypeError** exception.
5. Let *searchStr* be ? `ToString(searchString)`.
6. Let *pos* be ? `ToIntegerOrInfinity(position)`.
7. **Assert**: If *position* is **undefined**, then *pos* is 0.
8. Let *len* be the length of *S*.
9. Let *start* be the result of `clamping pos` between 0 and *len*.
10. Let *index* be `StringIndexOf(S, searchStr, start)`.
11. If *index* ≠ -1, return **true**.

12. Return **false**.

NOTE 1 If *searchString* appears as a substring of the result of converting this object to a String, at one or more indices that are greater than or equal to *position*, this function returns **true**; otherwise, it returns **false**. If *position* is **undefined**, 0 is assumed, so as to search all of the String.

NOTE 2 Throwing an exception if the first argument is a RegExp is specified in order to allow future editions to define extensions that allow such argument values.

NOTE 3 This method is intentionally generic; it does not require that its **this** value be a String object. Therefore, it can be transferred to other kinds of objects for use as a method.

### 22.1.3.9 String.prototype.indexOf ( *searchString* [ , *position* ] )

NOTE 1 If *searchString* appears as a substring of the result of converting this object to a String, at one or more indices that are greater than or equal to *position*, then the smallest such index is returned; otherwise, **-1**<sub>F</sub> is returned. If *position* is **undefined**, **+0**<sub>F</sub> is assumed, so as to search all of the String.

This method performs the following steps when called:

1. Let *O* be ? **RequireObjectCoercible**(**this** value).
2. Let *S* be ? **ToString**(*O*).
3. Let *searchStr* be ? **ToString**(*searchString*).
4. Let *pos* be ? **ToIntegerOrInfinity**(*position*).
5. **Assert**: If *position* is **undefined**, then *pos* is 0.
6. Let *len* be the length of *S*.
7. Let *start* be the result of **clamping** *pos* between 0 and *len*.
8. Return **ℱ**(**StringIndexOf**(*S*, *searchStr*, *start*)).

NOTE 2 This method is intentionally generic; it does not require that its **this** value be a String object. Therefore, it can be transferred to other kinds of objects for use as a method.

### 22.1.3.10 String.prototype.lastIndexOf ( *searchString* [ , *position* ] )

NOTE 1 If *searchString* appears as a substring of the result of converting this object to a String at one or more indices that are smaller than or equal to *position*, then the greatest such index is returned; otherwise, **-1**<sub>F</sub> is returned. If *position* is **undefined**, the length of the String value is assumed, so as to search all of the String.

This method performs the following steps when called:

1. Let *O* be ? **RequireObjectCoercible**(**this** value).
2. Let *S* be ? **ToString**(*O*).
3. Let *searchStr* be ? **ToString**(*searchString*).
4. Let *numPos* be ? **ToNumber**(*position*).
5. **Assert**: If *position* is **undefined**, then *numPos* is **NaN**.
6. If *numPos* is **NaN**, let *pos* be **+∞**; otherwise, let *pos* be ! **ToIntegerOrInfinity**(*numPos*).

7. Let *len* be the length of *S*.
8. Let *searchLen* be the length of *searchStr*.
9. Let *start* be the result of *clamping pos* between 0 and *len - searchLen*.
10. If *searchStr* is the empty String, return  $\mathbb{F}(\textit{start})$ .
11. For each integer *i* such that  $0 \leq i \leq \textit{start}$ , in descending order, do
  - a. Let *candidate* be the *substring* of *S* from *i* to *i + searchLen*.
  - b. If *candidate* is *searchStr*, return  $\mathbb{F}(i)$ .
12. Return  $-1_{\mathbb{F}}$ .

NOTE 2 This method is intentionally generic; it does not require that its **this** value be a String object. Therefore, it can be transferred to other kinds of objects for use as a method.

### 22.1.3.11 String.prototype.localeCompare ( *that* [ , *reserved1* [ , *reserved2* ] ] )

An ECMAScript implementation that includes the ECMA-402 Internationalization API must implement this method as specified in the ECMA-402 specification. If an ECMAScript implementation does not include the ECMA-402 API the following specification of this method is used:

This method returns a Number other than **NaN** representing the result of an *implementation-defined* locale-sensitive String comparison of the **this** value (converted to a String *S*) with *that* (converted to a String *thatValue*). The result is intended to correspond with a *sort order* of String values according to conventions of the *host environment*'s current locale, and will be negative when *S* is ordered before *thatValue*, positive when *S* is ordered after *thatValue*, and zero in all other cases (representing no relative ordering between *S* and *thatValue*).

Before performing the comparisons, this method performs the following steps to prepare the Strings:

1. Let *O* be ? *RequireObjectCoercible*(**this** value).
2. Let *S* be ? *ToString*(*O*).
3. Let *thatValue* be ? *ToString*(*that*).

The meaning of the optional second and third parameters to this method are defined in the ECMA-402 specification; implementations that do not include ECMA-402 support must not assign any other interpretation to those parameter positions.

The actual return values are *implementation-defined* to permit encoding additional information in them, but this method, when considered as a method of two arguments, is required to be a *consistent comparator* defining a total ordering on the set of all Strings. This method is also required to recognize and honour canonical equivalence according to the Unicode Standard, including returning  $+0_{\mathbb{F}}$  when comparing distinguishable Strings that are canonically equivalent.

NOTE 1 This method itself is not directly suitable as an argument to **Array.prototype.sort** because the latter requires a function of two arguments.

NOTE 2 This method may rely on whatever language- and/or locale-sensitive comparison functionality is available to the ECMAScript environment from the *host environment*, and is intended to compare according to the conventions of the *host environment*'s current locale. However, regardless of comparison capabilities, this method must recognize and honour canonical equivalence according to the Unicode Standard—for example, the following comparisons must all return  $+0_{\mathbb{F}}$ :

```
// Å ANGSTROM SIGN vs.
// Å LATIN CAPITAL LETTER A + COMBINING RING ABOVE
"\u212B".localeCompare("A\u030A")
```

```
// Ω OHM SIGN vs.
// Ω GREEK CAPITAL LETTER OMEGA
"\u2126".localeCompare("\u03A9")

// ſ LATIN SMALL LETTER S WITH DOT BELOW AND DOT ABOVE vs.
// ſ LATIN SMALL LETTER S + COMBINING DOT ABOVE + COMBINING DOT BELOW
"\u1E69".localeCompare("s\u0307\u0323")

// đ LATIN SMALL LETTER D WITH DOT ABOVE + COMBINING DOT BELOW vs.
// đ LATIN SMALL LETTER D WITH DOT BELOW + COMBINING DOT ABOVE
"\u1E0B\u0323".localeCompare("\u1E0D\u0307")

// 가 HANGUL CHOSEONG KIYEOK + HANGUL JUNGSEONG A vs.
// 가 HANGUL SYLLABLE GA
"\u1100\u1161".localeCompare("\uAC00")
```

For a definition and discussion of canonical equivalence see the Unicode Standard, chapters 2 and 3, as well as [Unicode Standard Annex #15, Unicode Normalization Forms](#) and [Unicode Technical Note #5, Canonical Equivalence in Applications](#). Also see [Unicode Technical Standard #10, Unicode Collation Algorithm](#).

It is recommended that this method should not honour Unicode compatibility equivalents or compatibility decompositions as defined in the Unicode Standard, chapter 3, section 3.7.

**NOTE 3** This method is intentionally generic; it does not require that its **this** value be a String object. Therefore, it can be transferred to other kinds of objects for use as a method.

### 22.1.3.12 String.prototype.match ( *regexp* )

This method performs the following steps when called:

1. Let *O* be ? [RequireObjectCoercible](#)(**this** value).
2. If *regexp* is neither **undefined** nor **null**, then
  - a. Let *matcher* be ? [GetMethod](#)(*regexp*, @@match).
  - b. If *matcher* is not **undefined**, then
    - i. Return ? [Call](#)(*matcher*, *regexp*, « *O* »).
3. Let *S* be ? [ToString](#)(*O*).
4. Let *rx* be ? [RegExpCreate](#)(*regexp*, **undefined**).
5. Return ? [Invoke](#)(*rx*, @@match, « *S* »).

**NOTE** This method is intentionally generic; it does not require that its **this** value be a String object. Therefore, it can be transferred to other kinds of objects for use as a method.

### 22.1.3.13 String.prototype.matchAll ( *regexp* )

This method performs a regular expression match of the String representing the **this** value against *regexp* and returns an iterator. Each iteration result's value is an Array containing the results of the match, or **null** if the String did not match.

It performs the following steps when called:

1. Let *O* be ? [RequireObjectCoercible](#)(**this** value).
2. If *regexp* is neither **undefined** nor **null**, then
  - a. Let *isRegExp* be ? [IsRegExp](#)(*regexp*).

- b. If *isRegExp* is **true**, then
    - i. Let *flags* be ? *Get*(*regexp*, "flags").
    - ii. Perform ? *RequireObjectCoercible*(*flags*).
    - iii. If ? *ToString*(*flags*) does not contain "g", throw a **TypeError** exception.
  - c. Let *matcher* be ? *GetMethod*(*regexp*, @@matchAll).
  - d. If *matcher* is not **undefined**, then
    - i. Return ? *Call*(*matcher*, *regexp*, « *O* »).
3. Let *S* be ? *ToString*(*O*).
  4. Let *rx* be ? *RegExpCreate*(*regexp*, "g").
  5. Return ? *Invoke*(*rx*, @@matchAll, « *S* »).

NOTE 1 This method is intentionally generic, it does not require that its **this** value be a String object. Therefore, it can be transferred to other kinds of objects for use as a method.

NOTE 2 Similarly to **String.prototype.split**, **String.prototype.matchAll** is designed to typically act without mutating its inputs.

#### 22.1.3.14 String.prototype.normalize ( [ *form* ] )

This method performs the following steps when called:

1. Let *O* be ? *RequireObjectCoercible*(**this** value).
2. Let *S* be ? *ToString*(*O*).
3. If *form* is **undefined**, let *f* be "NFC".
4. Else, let *f* be ? *ToString*(*form*).
5. If *f* is not one of "NFC", "NFD", "NFKC", or "NFKD", throw a **RangeError** exception.
6. Let *ns* be the String value that is the result of normalizing *S* into the normalization form named by *f* as specified in <https://unicode.org/reports/tr15/>.
7. Return *ns*.

NOTE This method is intentionally generic; it does not require that its **this** value be a String object. Therefore it can be transferred to other kinds of objects for use as a method.

#### 22.1.3.15 String.prototype.padEnd ( *maxLength* [ , *fillString* ] )

This method performs the following steps when called:

1. Let *O* be ? *RequireObjectCoercible*(**this** value).
2. Return ? *StringPad*(*O*, *maxLength*, *fillString*, end).

#### 22.1.3.16 String.prototype.padStart ( *maxLength* [ , *fillString* ] )

This method performs the following steps when called:

1. Let *O* be ? *RequireObjectCoercible*(**this** value).
2. Return ? *StringPad*(*O*, *maxLength*, *fillString*, start).

### 22.1.3.16.1 StringPad ( *O*, *maxLength*, *fillString*, *placement* )

The abstract operation StringPad takes arguments *O* (an ECMAScript language value), *maxLength* (an ECMAScript language value), *fillString* (an ECMAScript language value), and *placement* (start or end) and returns either a normal completion containing a String or a throw completion. It performs the following steps when called:

1. Let *S* be ? ToString(*O*).
2. Let *intMaxLength* be  $\mathbb{R}(? \text{ToLength}(\textit{maxLength}))$ .
3. Let *stringLength* be the length of *S*.
4. If *intMaxLength*  $\leq$  *stringLength*, return *S*.
5. If *fillString* is **undefined**, let *filler* be the String value consisting solely of the code unit 0x0020 (SPACE).
6. Else, let *filler* be ? ToString(*fillString*).
7. If *filler* is the empty String, return *S*.
8. Let *fillLen* be *intMaxLength* - *stringLength*.
9. Let *truncatedStringFiller* be the String value consisting of repeated concatenations of *filler* truncated to length *fillLen*.
10. If *placement* is start, return the string-concatenation of *truncatedStringFiller* and *S*.
11. Else, return the string-concatenation of *S* and *truncatedStringFiller*.

NOTE 1 The argument *maxLength* will be clamped such that it can be no smaller than the length of *S*.

NOTE 2 The argument *fillString* defaults to " " (the String value consisting of the code unit 0x0020 SPACE).

### 22.1.3.16.2 ToZeroPaddedDecimalString ( *n*, *minLength* )

The abstract operation ToZeroPaddedDecimalString takes arguments *n* (a non-negative integer) and *minLength* (a non-negative integer) and returns a String. It performs the following steps when called:

1. Let *S* be the String representation of *n*, formatted as a decimal number.
2. Return ! StringPad(*S*,  $\mathbb{F}(\textit{minLength})$ , "0", start).

### 22.1.3.17 String.prototype.repeat ( *count* )

This method performs the following steps when called:

1. Let *O* be ? RequireObjectCoercible(this value).
2. Let *S* be ? ToString(*O*).
3. Let *n* be ? ToIntegerOrInfinity(*count*).
4. If *n* < 0 or *n* =  $+\infty$ , throw a **RangeError** exception.
5. If *n* = 0, return the empty String.
6. Return the String value that is made from *n* copies of *S* appended together.

NOTE 1 This method creates the String value consisting of the code units of the **this** value (converted to String) repeated *count* times.

NOTE 2 This method is intentionally generic; it does not require that its **this** value be a String object. Therefore, it can be transferred to other kinds of objects for use as a method.

### 22.1.3.18 String.prototype.replace ( *searchValue*, *replaceValue* )

This method performs the following steps when called:

1. Let *O* be ? [RequireObjectCoercible](#)(**this** value).
2. If *searchValue* is neither **undefined** nor **null**, then
  - a. Let *replacer* be ? [GetMethod](#)(*searchValue*, @@replace).
  - b. If *replacer* is not **undefined**, then
    - i. Return ? [Call](#)(*replacer*, *searchValue*, « *O*, *replaceValue* »).
3. Let *string* be ? [ToString](#)(*O*).
4. Let *searchString* be ? [ToString](#)(*searchValue*).
5. Let *functionalReplace* be [IsCallable](#)(*replaceValue*).
6. If *functionalReplace* is **false**, then
  - a. Set *replaceValue* to ? [ToString](#)(*replaceValue*).
7. Let *searchLength* be the length of *searchString*.
8. Let *position* be [StringIndexOf](#)(*string*, *searchString*, 0).
9. If *position* = -1, return *string*.
10. Let *preceding* be the [substring](#) of *string* from 0 to *position*.
11. Let *following* be the [substring](#) of *string* from *position* + *searchLength*.
12. If *functionalReplace* is **true**, then
  - a. Let *replacement* be ? [ToString](#)(? [Call](#)(*replaceValue*, **undefined**, « *searchString*,  $\mathbb{F}$ (*position*), *string* »)).
13. Else,
  - a. [Assert](#): *replaceValue* is a String.
  - b. Let *captures* be a new empty List.
  - c. Let *replacement* be ! [GetSubstitution](#)(*searchString*, *string*, *position*, *captures*, **undefined**, *replaceValue*).
14. Return the [string-concatenation](#) of *preceding*, *replacement*, and *following*.

**NOTE** This method is intentionally generic; it does not require that its **this** value be a String object. Therefore, it can be transferred to other kinds of objects for use as a method.

#### 22.1.3.18.1 GetSubstitution (*matched*, *str*, *position*, *captures*, *namedCaptures*, *replacementTemplate*)

The abstract operation [GetSubstitution](#) takes arguments *matched* (a String), *str* (a String), *position* (a non-negative integer), *captures* (a possibly empty List, each of whose elements is a String or **undefined**), *namedCaptures* (an Object or **undefined**), and *replacementTemplate* (a String) and returns either a [normal completion](#) containing a String or a [throw completion](#). For the purposes of this abstract operation, a *decimal digit* is a code unit in the [inclusive interval](#) from 0x0030 (DIGIT ZERO) to 0x0039 (DIGIT NINE). It performs the following steps when called:

1. Let *stringLength* be the length of *str*.
2. [Assert](#): *position* ≤ *stringLength*.
3. Let *result* be the empty String.
4. Let *templateRemainder* be *replacementTemplate*.
5. Repeat, while *templateRemainder* is not the empty String,
  - a. **NOTE**: The following steps isolate *ref* (a prefix of *templateRemainder*), determine *refReplacement* (its replacement), and then append that replacement to *result*.
  - b. If *templateRemainder* starts with "\$\$", then
    - i. Let *ref* be "\$\$".
    - ii. Let *refReplacement* be "\$".

- c. Else if *templateRemainder* starts with "\$`", then
    - i. Let *ref* be "\$`".
    - ii. Let *refReplacement* be the *substring* of *str* from 0 to *position*.
  - d. Else if *templateRemainder* starts with "\$&", then
    - i. Let *ref* be "\$&".
    - ii. Let *refReplacement* be *matched*.
  - e. Else if *templateRemainder* starts with "\$" (0x0024 (DOLLAR SIGN) followed by 0x0027 (APOSTROPHE)), then
    - i. Let *ref* be "\$".
    - ii. Let *matchLength* be the length of *matched*.
    - iii. Let *tailPos* be *position* + *matchLength*.
    - iv. Let *refReplacement* be the *substring* of *str* from *min*(*tailPos*, *stringLength*).
    - v. NOTE: *tailPos* can exceed *stringLength* only if this abstract operation was invoked by a call to the intrinsic @@replace method of %RegExp.prototype% on an object whose "exec" property is not the intrinsic %RegExp.prototype.exec%.
  - f. Else if *templateRemainder* starts with "\$" followed by 1 or more decimal digits, then
    - i. If *templateRemainder* starts with "\$" followed by 2 or more decimal digits, let *digitCount* be 2. Otherwise, let *digitCount* be 1.
    - ii. Let *ref* be the *substring* of *templateRemainder* from 0 to 1 + *digitCount*.
    - iii. Let *digits* be the *substring* of *templateRemainder* from 1 to 1 + *digitCount*.
    - iv. Let *index* be  $\mathbb{R}(\text{StringToNumber}(\text{digits}))$ .
    - v. Assert:  $0 \leq \text{index} \leq 99$ .
    - vi. Let *captureLen* be the number of elements in *captures*.
    - vii. If  $1 \leq \text{index} \leq \text{captureLen}$ , then
      - 1. Let *capture* be *captures*[*index* - 1].
      - 2. If *capture* is **undefined**, then
        - a. Let *refReplacement* be the empty String.
      - 3. Else,
        - a. Let *refReplacement* be *capture*.
    - viii. Else,
      - 1. Let *refReplacement* be *ref*.
  - g. Else if *templateRemainder* starts with "\$<", then
    - i. Let *gtPos* be *StringIndexOf*(*templateRemainder*, ">", 0).
    - ii. If *gtPos* = -1 or *namedCaptures* is **undefined**, then
      - 1. Let *ref* be "\$<".
      - 2. Let *refReplacement* be *ref*.
    - iii. Else,
      - 1. Let *ref* be the *substring* of *templateRemainder* from 0 to *gtPos* + 1.
      - 2. Let *groupName* be the *substring* of *templateRemainder* from 2 to *gtPos*.
      - 3. Assert: *namedCaptures* is an Object.
      - 4. Let *capture* be ? *Get*(*namedCaptures*, *groupName*).
      - 5. If *capture* is **undefined**, then
        - a. Let *refReplacement* be the empty String.
      - 6. Else,
        - a. Let *refReplacement* be ? *ToString*(*capture*).
  - h. Else,
    - i. Let *ref* be the *substring* of *templateRemainder* from 0 to 1.
    - ii. Let *refReplacement* be *ref*.
    - i. Let *refLength* be the length of *ref*.
    - j. Set *templateRemainder* to the *substring* of *templateRemainder* from *refLength*.
    - k. Set *result* to the *string-concatenation* of *result* and *refReplacement*.
6. Return *result*.



### 22.1.3.19 String.prototype.replaceAll ( *searchValue*, *replaceValue* )

This method performs the following steps when called:

1. Let *O* be ? [RequireObjectCoercible](#)(**this** value).
2. If *searchValue* is neither **undefined** nor **null**, then
  - a. Let *isRegExp* be ? [IsRegExp](#)(*searchValue*).
  - b. If *isRegExp* is **true**, then
    - i. Let *flags* be ? [Get](#)(*searchValue*, "flags").
    - ii. Perform ? [RequireObjectCoercible](#)(*flags*).
    - iii. If ? [ToString](#)(*flags*) does not contain "g", throw a **TypeError** exception.
  - c. Let *replacer* be ? [GetMethod](#)(*searchValue*, @@replace).
  - d. If *replacer* is not **undefined**, then
    - i. Return ? [Call](#)(*replacer*, *searchValue*, « *O*, *replaceValue* »).
3. Let *string* be ? [ToString](#)(*O*).
4. Let *searchString* be ? [ToString](#)(*searchValue*).
5. Let *functionalReplace* be [IsCallable](#)(*replaceValue*).
6. If *functionalReplace* is **false**, then
  - a. Set *replaceValue* to ? [ToString](#)(*replaceValue*).
7. Let *searchLength* be the length of *searchString*.
8. Let *advanceBy* be [max](#)(1, *searchLength*).
9. Let *matchPositions* be a new empty [List](#).
10. Let *position* be [StringIndexOf](#)(*string*, *searchString*, 0).
11. Repeat, while *position* ≠ -1,
  - a. Append *position* to *matchPositions*.
  - b. Set *position* to [StringIndexOf](#)(*string*, *searchString*, *position* + *advanceBy*).
12. Let *endOfLastMatch* be 0.
13. Let *result* be the empty [String](#).
14. For each element *p* of *matchPositions*, do
  - a. Let *preserved* be the [substring](#) of *string* from *endOfLastMatch* to *p*.
  - b. If *functionalReplace* is **true**, then
    - i. Let *replacement* be ? [ToString](#)(? [Call](#)(*replaceValue*, **undefined**, « *searchString*, [F](#)(*p*), *string* »)).
  - c. Else,
    - i. **Assert**: *replaceValue* is a [String](#).
    - ii. Let *captures* be a new empty [List](#).
    - iii. Let *replacement* be ! [GetSubstitution](#)(*searchString*, *string*, *p*, *captures*, **undefined**, *replaceValue*).
  - d. Set *result* to the [string-concatenation](#) of *result*, *preserved*, and *replacement*.
  - e. Set *endOfLastMatch* to *p* + *searchLength*.
15. If *endOfLastMatch* < the length of *string*, then
  - a. Set *result* to the [string-concatenation](#) of *result* and the [substring](#) of *string* from *endOfLastMatch*.
16. Return *result*.

### 22.1.3.20 String.prototype.search ( *regex* )

This method performs the following steps when called:

1. Let *O* be ? [RequireObjectCoercible](#)(**this** value).
2. If *regex* is neither **undefined** nor **null**, then

- a. Let *searcher* be ? `GetMethod(regex, @@search)`.
- b. If *searcher* is not **undefined**, then
  - i. Return ? `Call(searcher, regex, « O »)`.
3. Let *string* be ? `ToString(O)`.
4. Let *rx* be ? `RegExpCreate(regex, undefined)`.
5. Return ? `Invoke(rx, @@search, « string »)`.

**NOTE** This method is intentionally generic; it does not require that its **this** value be a String object. Therefore, it can be transferred to other kinds of objects for use as a method.

### 22.1.3.21 `String.prototype.slice` ( *start*, *end* )

This method returns a substring of the result of converting this object to a String, starting from index *start* and running to, but not including, index *end* (or through the end of the String if *end* is **undefined**). If *start* is negative, it is treated as `sourceLength + start` where `sourceLength` is the length of the String. If *end* is negative, it is treated as `sourceLength + end` where `sourceLength` is the length of the String. The result is a String value, not a String object.

It performs the following steps when called:

1. Let *O* be ? `RequireObjectCoercible(this value)`.
2. Let *S* be ? `ToString(O)`.
3. Let *len* be the length of *S*.
4. Let *intStart* be ? `ToIntegerOrInfinity(start)`.
5. If *intStart* =  $-\infty$ , let *from* be 0.
6. Else if *intStart* < 0, let *from* be `max(len + intStart, 0)`.
7. Else, let *from* be `min(intStart, len)`.
8. If *end* is **undefined**, let *intEnd* be *len*; else let *intEnd* be ? `ToIntegerOrInfinity(end)`.
9. If *intEnd* =  $-\infty$ , let *to* be 0.
10. Else if *intEnd* < 0, let *to* be `max(len + intEnd, 0)`.
11. Else, let *to* be `min(intEnd, len)`.
12. If *from* ≥ *to*, return the empty String.
13. Return the `substring` of *S* from *from* to *to*.

**NOTE** This method is intentionally generic; it does not require that its **this** value be a String object. Therefore it can be transferred to other kinds of objects for use as a method.

### 22.1.3.22 `String.prototype.split` ( *separator*, *limit* )

This method returns an Array into which substrings of the result of converting this object to a String have been stored. The substrings are determined by searching from left to right for occurrences of *separator*; these occurrences are not part of any String in the returned array, but serve to divide up the String value. The value of *separator* may be a String of any length or it may be an object, such as a RegExp, that has a `@@split` method.

It performs the following steps when called:

1. Let *O* be ? `RequireObjectCoercible(this value)`.
2. If *separator* is neither **undefined** nor **null**, then
  - a. Let *splitter* be ? `GetMethod(separator, @@split)`.
  - b. If *splitter* is not **undefined**, then
    - i. Return ? `Call(splitter, separator, « O, limit »)`.

3. Let *S* be ? ToString(*O*).
4. If *limit* is **undefined**, let *lim* be  $2^{32} - 1$ ; else let *lim* be  $\mathbb{R}(\text{? ToUint32}(\textit{limit}))$ .
5. Let *R* be ? ToString(*separator*).
6. If *lim* = 0, then
  - a. Return CreateArrayFromList(« »).
7. If *separator* is **undefined**, then
  - a. Return CreateArrayFromList(« *S* »).
8. Let *separatorLength* be the length of *R*.
9. If *separatorLength* = 0, then
  - a. Let *head* be the substring of *S* from 0 to *lim*.
  - b. Let *codeUnits* be a List consisting of the sequence of code units that are the elements of *head*.
  - c. Return CreateArrayFromList(*codeUnits*).
10. If *S* is the empty String, return CreateArrayFromList(« *S* »).
11. Let *substrings* be a new empty List.
12. Let *i* be 0.
13. Let *j* be StringIndexOf(*S*, *R*, 0).
14. Repeat, while *j* ≠ -1,
  - a. Let *T* be the substring of *S* from *i* to *j*.
  - b. Append *T* to *substrings*.
  - c. If the number of elements in *substrings* is *lim*, return CreateArrayFromList(*substrings*).
  - d. Set *i* to *j* + *separatorLength*.
  - e. Set *j* to StringIndexOf(*S*, *R*, *i*).
15. Let *T* be the substring of *S* from *i*.
16. Append *T* to *substrings*.
17. Return CreateArrayFromList(*substrings*).

NOTE 1 The value of *separator* may be an empty String. In this case, *separator* does not match the empty substring at the beginning or end of the input String, nor does it match the empty substring at the end of the previous separator match. If *separator* is the empty String, the String is split up into individual code unit elements; the length of the result array equals the length of the String, and each substring contains one code unit.

If the **this** value is (or converts to) the empty String, the result depends on whether *separator* can match the empty String. If it can, the result array contains no elements. Otherwise, the result array contains one element, which is the empty String.

If *separator* is **undefined**, then the result array contains just one String, which is the **this** value (converted to a String). If *limit* is not **undefined**, then the output array is truncated so that it contains no more than *limit* elements.

NOTE 2 This method is intentionally generic; it does not require that its **this** value be a String object. Therefore, it can be transferred to other kinds of objects for use as a method.

### 22.1.3.23 String.prototype.startsWith ( *searchString* [ , *position* ] )

This method performs the following steps when called:

1. Let *O* be ? RequireObjectCoercible(**this** value).
2. Let *S* be ? ToString(*O*).
3. Let *isRegExp* be ? IsRegExp(*searchString*).
4. If *isRegExp* is **true**, throw a **TypeError** exception.
5. Let *searchStr* be ? ToString(*searchString*).

6. Let *len* be the length of *S*.
7. If *position* is **undefined**, let *pos* be 0; else let *pos* be ? *ToIntegerOrInfinity*(*position*).
8. Let *start* be the result of *clamping* *pos* between 0 and *len*.
9. Let *searchLength* be the length of *searchStr*.
10. If *searchLength* = 0, return **true**.
11. Let *end* be *start* + *searchLength*.
12. If *end* > *len*, return **false**.
13. Let *substring* be the *substring* of *S* from *start* to *end*.
14. If *substring* is *searchStr*, return **true**.
15. Return **false**.

NOTE 1 This method returns **true** if the sequence of code units of *searchString* converted to a String is the same as the corresponding code units of this object (converted to a String) starting at index *position*. Otherwise it returns **false**.

NOTE 2 Throwing an exception if the first argument is a RegExp is specified in order to allow future editions to define extensions that allow such argument values.

NOTE 3 This method is intentionally generic; it does not require that its **this** value be a String object. Therefore, it can be transferred to other kinds of objects for use as a method.

### 22.1.3.24 String.prototype.substring ( *start*, *end* )

This method returns a substring of the result of converting this object to a String, starting from index *start* and running to, but not including, index *end* of the String (or through the end of the String if *end* is **undefined**). The result is a String value, not a String object.

If either argument is **NaN** or negative, it is replaced with zero; if either argument is strictly greater than the length of the String, it is replaced with the length of the String.

If *start* is strictly greater than *end*, they are swapped.

It performs the following steps when called:

1. Let *O* be ? *RequireObjectCoercible*(**this** value).
2. Let *S* be ? *ToString*(*O*).
3. Let *len* be the length of *S*.
4. Let *intStart* be ? *ToIntegerOrInfinity*(*start*).
5. If *end* is **undefined**, let *intEnd* be *len*; else let *intEnd* be ? *ToIntegerOrInfinity*(*end*).
6. Let *finalStart* be the result of *clamping* *intStart* between 0 and *len*.
7. Let *finalEnd* be the result of *clamping* *intEnd* between 0 and *len*.
8. Let *from* be *min*(*finalStart*, *finalEnd*).
9. Let *to* be *max*(*finalStart*, *finalEnd*).
10. Return the *substring* of *S* from *from* to *to*.

NOTE This method is intentionally generic; it does not require that its **this** value be a String object. Therefore, it can be transferred to other kinds of objects for use as a method.

### 22.1.3.25 String.prototype.toLocaleLowerCase ( [ *reserved1* [ , *reserved2* ] ] )

An ECMAScript implementation that includes the ECMA-402 Internationalization API must implement this method as specified in the ECMA-402 specification. If an ECMAScript implementation does not include the ECMA-402 API the following specification of this method is used:

This method interprets a String value as a sequence of UTF-16 encoded code points, as described in 6.1.4.

It works exactly the same as **toLowerCase** except that it is intended to yield a locale-sensitive result corresponding with conventions of the **host environment's** current locale. There will only be a difference in the few cases (such as Turkish) where the rules for that language conflict with the regular Unicode case mappings.

The meaning of the optional parameters to this method are defined in the ECMA-402 specification; implementations that do not include ECMA-402 support must not use those parameter positions for anything else.

**NOTE** This method is intentionally generic; it does not require that its **this** value be a String object. Therefore, it can be transferred to other kinds of objects for use as a method.

### 22.1.3.26 String.prototype.toLocaleUpperCase ( [ *reserved1* [ , *reserved2* ] ] )

An ECMAScript implementation that includes the ECMA-402 Internationalization API must implement this method as specified in the ECMA-402 specification. If an ECMAScript implementation does not include the ECMA-402 API the following specification of this method is used:

This method interprets a String value as a sequence of UTF-16 encoded code points, as described in 6.1.4.

It works exactly the same as **toUpperCase** except that it is intended to yield a locale-sensitive result corresponding with conventions of the **host environment's** current locale. There will only be a difference in the few cases (such as Turkish) where the rules for that language conflict with the regular Unicode case mappings.

The meaning of the optional parameters to this method are defined in the ECMA-402 specification; implementations that do not include ECMA-402 support must not use those parameter positions for anything else.

**NOTE** This method is intentionally generic; it does not require that its **this** value be a String object. Therefore, it can be transferred to other kinds of objects for use as a method.

### 22.1.3.27 String.prototype.toLowerCase ( )

This method interprets a String value as a sequence of UTF-16 encoded code points, as described in 6.1.4.

It performs the following steps when called:

1. Let *O* be ? **RequireObjectCoercible**(**this** value).
2. Let *S* be ? **ToString**(*O*).
3. Let *sText* be **StringToCodePoints**(*S*).
4. Let *lowerText* be the result of **toLowerCase**(*sText*), according to the Unicode Default Case Conversion algorithm.
5. Let *L* be **CodePointsToString**(*lowerText*).
6. Return *L*.

The result must be derived according to the locale-insensitive case mappings in the Unicode Character Database (this explicitly includes not only the file <https://unicode.org/Public/UCD/latest/ucd/UnicodeData.txt>, but also all locale-insensitive mappings in the file <https://unicode.org/Public/UCD/latest/ucd/SpecialCasing.txt> that accompanies it).

NOTE 1 The case mapping of some code points may produce multiple code points. In this case the result String may not be the same length as the source String. Because both **toUpperCase** and **toLowerCase** have context-sensitive behaviour, the methods are not symmetrical. In other words, **s.toUpperCase().toLowerCase()** is not necessarily equal to **s.toLowerCase()**.

NOTE 2 This method is intentionally generic; it does not require that its **this** value be a String object. Therefore, it can be transferred to other kinds of objects for use as a method.

### 22.1.3.28 String.prototype.toString ( )

This method performs the following steps when called:

1. Return ? **thisStringValue**(**this** value).

NOTE For a String object, this method happens to return the same thing as the **valueOf** method.

### 22.1.3.29 String.prototype.toUpperCase ( )

This method interprets a String value as a sequence of UTF-16 encoded code points, as described in 6.1.4.

It behaves in exactly the same way as **String.prototype.toLowerCase**, except that the String is mapped using the toUppercase algorithm of the Unicode Default Case Conversion.

NOTE This method is intentionally generic; it does not require that its **this** value be a String object. Therefore, it can be transferred to other kinds of objects for use as a method.

### 22.1.3.30 String.prototype.trim ( )

This method interprets a String value as a sequence of UTF-16 encoded code points, as described in 6.1.4.

It performs the following steps when called:

1. Let **S** be the **this** value.
2. Return ? **TrimString**(**S**, start+end).

NOTE This method is intentionally generic; it does not require that its **this** value be a String object. Therefore, it can be transferred to other kinds of objects for use as a method.

#### 22.1.3.30.1 TrimString ( *string*, *where* )

The abstract operation TrimString takes arguments *string* (an ECMAScript language value) and *where* (start, end, or start+end) and returns either a normal completion containing a String or a throw completion. It interprets *string* as a sequence of UTF-16 encoded code points, as described in 6.1.4. It performs the following steps when called:

1. Let *str* be ? `RequireObjectCoercible(string)`.
2. Let *S* be ? `ToString(str)`.
3. If *where* is start, let *T* be the String value that is a copy of *S* with leading white space removed.
4. Else if *where* is end, let *T* be the String value that is a copy of *S* with trailing white space removed.
5. Else,
  - a. **Assert:** *where* is start+end.
  - b. Let *T* be the String value that is a copy of *S* with both leading and trailing white space removed.
6. Return *T*.

The definition of white space is the union of *WhiteSpace* and *LineTerminator*. When determining whether a Unicode code point is in Unicode general category “Space\_Separator” (“Zs”), code unit sequences are interpreted as UTF-16 encoded code point sequences as specified in 6.1.4.

### 22.1.3.31 `String.prototype.trimEnd ( )`

This method interprets a String value as a sequence of UTF-16 encoded code points, as described in 6.1.4.

It performs the following steps when called:

1. Let *S* be the **this** value.
2. Return ? `TrimString(S, end)`.

**NOTE** This method is intentionally generic; it does not require that its **this** value be a String object. Therefore, it can be transferred to other kinds of objects for use as a method.

### 22.1.3.32 `String.prototype.trimStart ( )`

This method interprets a String value as a sequence of UTF-16 encoded code points, as described in 6.1.4.

It performs the following steps when called:

1. Let *S* be the **this** value.
2. Return ? `TrimString(S, start)`.

**NOTE** This method is intentionally generic; it does not require that its **this** value be a String object. Therefore, it can be transferred to other kinds of objects for use as a method.

### 22.1.3.33 `String.prototype.valueOf ( )`

This method performs the following steps when called:

1. Return ? `thisStringValue(this value)`.

### 22.1.3.34 `String.prototype [ @@iterator ] ( )`

This method returns an Iterator object (27.1.1.2) that iterates over the code points of a String value, returning each code point as a String value.

It performs the following steps when called:

1. Let *O* be ? `RequireObjectCoercible(this value)`.

2. Let *s* be ? `ToString(O)`.
3. Let *closure* be a new `Abstract Closure` with no parameters that captures *s* and performs the following steps when called:
  - a. Let *len* be the length of *s*.
  - b. Let *position* be 0.
  - c. Repeat, while *position* < *len*,
    - i. Let *cp* be `CodePointAt(s, position)`.
    - ii. Let *nextIndex* be *position* + *cp*.`[[CodeUnitCount]]`.
    - iii. Let *resultString* be the substring of *s* from *position* to *nextIndex*.
    - iv. Set *position* to *nextIndex*.
    - v. Perform ? `GeneratorYield(CreateIterResultObject(resultString, false))`.
  - d. Return `undefined`.
4. Return `CreateIteratorFromClosure(closure, "%StringIteratorPrototype%", %StringIteratorPrototype%)`.

The value of the "name" property of this method is "[Symbol.iterator]".

## 22.1.4 Properties of String Instances

String instances are `String exotic objects` and have the internal methods specified for such objects. String instances inherit properties from the `String prototype object`. String instances also have a `[[StringData]]` internal slot.

String instances have a "length" property, and a set of enumerable properties with `integer`-indexed names.

### 22.1.4.1 length

The number of elements in the String value represented by this String object.

Once a String object is initialized, this property is unchanging. It has the attributes { `[[Writable]]`: **false**, `[[Enumerable]]`: **false**, `[[Configurable]]`: **false** }.

## 22.1.5 String Iterator Objects

A String Iterator is an object, that represents a specific iteration over some specific String instance object. There is not a named `constructor` for String Iterator objects. Instead, String iterator objects are created by calling certain methods of String instance objects.

### 22.1.5.1 The %StringIteratorPrototype% Object

The `%StringIteratorPrototype%` object:

- has properties that are inherited by all String Iterator Objects.
- is an `ordinary object`.
- has a `[[Prototype]]` internal slot whose value is `%IteratorPrototype%`.
- has the following properties:

#### 22.1.5.1.1 %StringIteratorPrototype%.next ( )

1. Return ? `GeneratorResume(this value, empty, "%StringIteratorPrototype%")`.



### 22.1.5.1.2 %StringIteratorPrototype% [ @@toStringTag ]

The initial value of the @@toStringTag property is the String value "String Iterator".

This property has the attributes { [[Writable]]: false, [[Enumerable]]: false, [[Configurable]]: true }.

## 22.2 RegExp (Regular Expression) Objects

A RegExp object contains a regular expression and the associated flags.

**NOTE** The form and functionality of regular expressions is modelled after the regular expression facility in the Perl 5 programming language.

### 22.2.1 Patterns

The RegExp constructor applies the following grammar to the input pattern String. An error occurs if the grammar cannot interpret the String as an expansion of *Pattern*.

#### Syntax

```

Pattern[UnicodeMode, N] ::
    Disjunction[?UnicodeMode, ?N]

Disjunction[UnicodeMode, N] ::
    Alternative[?UnicodeMode, ?N]
    Alternative[?UnicodeMode, ?N] | Disjunction[?UnicodeMode, ?N]

Alternative[UnicodeMode, N] ::
    [empty]
    Alternative[?UnicodeMode, ?N] Term[?UnicodeMode, ?N]

Term[UnicodeMode, N] ::
    Assertion[?UnicodeMode, ?N]
    Atom[?UnicodeMode, ?N]
    Atom[?UnicodeMode, ?N] Quantifier

Assertion[UnicodeMode, N] ::
    ^
    $
    \b
    \B
    (?= Disjunction[?UnicodeMode, ?N] )
    (?! Disjunction[?UnicodeMode, ?N] )
    (?<= Disjunction[?UnicodeMode, ?N] )
    (?<! Disjunction[?UnicodeMode, ?N] )

Quantifier ::
    QuantifierPrefix
    QuantifierPrefix ?

QuantifierPrefix ::

```

```

*
+
?
{ DecimalDigits[~Sep] }
{ DecimalDigits[~Sep] , }
{ DecimalDigits[~Sep] , DecimalDigits[~Sep] }

Atom[UnicodeMode, N] ::
  PatternCharacter
  .
  \ AtomEscape[?UnicodeMode, ?N]
  CharacterClass[?UnicodeMode]
  ( GroupSpecifier[?UnicodeMode] opt Disjunction[?UnicodeMode, ?N] )
  (? : Disjunction[?UnicodeMode, ?N] )

SyntaxCharacter :: one of
  ^ $ \ . * + ? ( ) [ ] { } |

PatternCharacter ::
  SourceCharacter but not SyntaxCharacter

AtomEscape[UnicodeMode, N] ::
  DecimalEscape
  CharacterClassEscape[?UnicodeMode]
  CharacterEscape[?UnicodeMode]
  [+N] k GroupName[?UnicodeMode]

CharacterEscape[UnicodeMode] ::
  ControlEscape
  c AsciiLetter
  o [lookahead ≠ DecimalDigit]
  HexEscapeSequence
  RegExpUnicodeEscapeSequence[?UnicodeMode]
  IdentityEscape[?UnicodeMode]

ControlEscape :: one of
  f n r t v

GroupSpecifier[UnicodeMode] ::
  ? GroupName[?UnicodeMode]

GroupName[UnicodeMode] ::
  < RegExpIdentifierName[?UnicodeMode] >

RegExpIdentifierName[UnicodeMode] ::
  RegExpIdentifierStart[?UnicodeMode]
  RegExpIdentifierName[?UnicodeMode] RegExpIdentifierPart[?UnicodeMode]

RegExpIdentifierStart[UnicodeMode] ::
  IdentifierStartChar
  \ RegExpUnicodeEscapeSequence[+UnicodeMode]
  [-UnicodeMode] UnicodeLeadSurrogate UnicodeTrailSurrogate

```

*RegExpIdentifierPart*<sub>[UnicodeMode]</sub> ::  
*IdentifierPartChar*  
 \ *RegExpUnicodeEscapeSequence*<sub>[+UnicodeMode]</sub>  
<sub>[~UnicodeMode]</sub> *UnicodeLeadSurrogate UnicodeTrailSurrogate*

*RegExpUnicodeEscapeSequence*<sub>[UnicodeMode]</sub> ::  
<sub>[+UnicodeMode]</sub> **u** *HexLeadSurrogate* \ **u** *HexTrailSurrogate*  
<sub>[+UnicodeMode]</sub> **u** *HexLeadSurrogate*  
<sub>[+UnicodeMode]</sub> **u** *HexTrailSurrogate*  
<sub>[+UnicodeMode]</sub> **u** *HexNonSurrogate*  
<sub>[~UnicodeMode]</sub> **u** *Hex4Digits*  
<sub>[+UnicodeMode]</sub> **u**{ *CodePoint* }

*UnicodeLeadSurrogate* ::  
 any Unicode code point in the inclusive interval from U+D800 to U+DBFF

*UnicodeTrailSurrogate* ::  
 any Unicode code point in the inclusive interval from U+DC00 to U+DFFF

Each \ *u HexTrailSurrogate* for which the choice of associated **u HexLeadSurrogate** is ambiguous shall be associated with the nearest possible **u HexLeadSurrogate** that would otherwise have no corresponding \ *u HexTrailSurrogate*.

*HexLeadSurrogate* ::  
*Hex4Digits* but only if the MV of *Hex4Digits* is in the **inclusive interval** from 0xD800 to 0xDBFF

*HexTrailSurrogate* ::  
*Hex4Digits* but only if the MV of *Hex4Digits* is in the **inclusive interval** from 0xDC00 to 0xDFFF

*HexNonSurrogate* ::  
*Hex4Digits* but only if the MV of *Hex4Digits* is not in the **inclusive interval** from 0xD800 to 0xDFFF

*IdentityEscape*<sub>[UnicodeMode]</sub> ::  
<sub>[+UnicodeMode]</sub> *SyntaxCharacter*  
<sub>[+UnicodeMode]</sub> /  
<sub>[~UnicodeMode]</sub> *SourceCharacter* but not *UnicodeIDContinue*

*DecimalEscape* ::  
*NonZeroDigit DecimalDigits*<sub>[~Sep]</sub> *opt* [lookahead ∉ *DecimalDigit*]

*CharacterClassEscape*<sub>[UnicodeMode]</sub> ::  
**d**  
**D**  
**s**  
**S**  
**w**  
**W**  
<sub>[+UnicodeMode]</sub> **p**{ *UnicodePropertyValueExpression* }  
<sub>[+UnicodeMode]</sub> **P**{ *UnicodePropertyValueExpression* }

*UnicodePropertyValueExpression* ::  
*UnicodePropertyName* = *UnicodePropertyValue*  
*LoneUnicodePropertyNameOrValue*

*UnicodePropertyName* ::

*UnicodePropertyNameCharacters*

*UnicodePropertyNameCharacters* ::  
*UnicodePropertyNameCharacter UnicodePropertyNameCharacters*<sub>opt</sub>

*UnicodePropertyValue* ::  
*UnicodePropertyValueCharacters*

*LoneUnicodePropertyNameOrValue* ::  
*UnicodePropertyValueCharacters*

*UnicodePropertyValueCharacters* ::  
*UnicodePropertyValueCharacter UnicodePropertyValueCharacters*<sub>opt</sub>

*UnicodePropertyValueCharacter* ::  
*UnicodePropertyNameCharacter*  
*DecimalDigit*

*UnicodePropertyNameCharacter* ::  
*AsciiLetter*

–

*CharacterClass*<sub>[UnicodeMode]</sub> ::  
 [ [lookahead ≠ ^] *ClassRanges*<sub>[?UnicodeMode]</sub> ]  
 [ ^ *ClassRanges*<sub>[?UnicodeMode]</sub> ]

*ClassRanges*<sub>[UnicodeMode]</sub> ::  
 [empty]  
*NonemptyClassRanges*<sub>[?UnicodeMode]</sub>

*NonemptyClassRanges*<sub>[UnicodeMode]</sub> ::  
*ClassAtom*<sub>[?UnicodeMode]</sub>  
*ClassAtom*<sub>[?UnicodeMode]</sub> *NonemptyClassRangesNoDash*<sub>[?UnicodeMode]</sub>  
*ClassAtom*<sub>[?UnicodeMode]</sub> – *ClassAtom*<sub>[?UnicodeMode]</sub> *ClassRanges*<sub>[?UnicodeMode]</sub>

*NonemptyClassRangesNoDash*<sub>[UnicodeMode]</sub> ::  
*ClassAtom*<sub>[?UnicodeMode]</sub>  
*ClassAtomNoDash*<sub>[?UnicodeMode]</sub> *NonemptyClassRangesNoDash*<sub>[?UnicodeMode]</sub>  
*ClassAtomNoDash*<sub>[?UnicodeMode]</sub> – *ClassAtom*<sub>[?UnicodeMode]</sub>  
*ClassRanges*<sub>[?UnicodeMode]</sub>

*ClassAtom*<sub>[UnicodeMode]</sub> ::  
 –  
*ClassAtomNoDash*<sub>[?UnicodeMode]</sub>

*ClassAtomNoDash*<sub>[UnicodeMode]</sub> ::  
*SourceCharacter* but not one of \ or ] or –  
 \ *ClassEscape*<sub>[?UnicodeMode]</sub>

*ClassEscape*<sub>[UnicodeMode]</sub> ::  
**b**  
 [+UnicodeMode] –  
*CharacterClassEscape*<sub>[?UnicodeMode]</sub>  
*CharacterEscape*<sub>[?UnicodeMode]</sub>

NOTE A number of productions in this section are given alternative definitions in section B.1.2.

### 22.2.1.1 Static Semantics: Early Errors

NOTE This section is amended in B.1.2.1.

*Pattern* :: *Disjunction*

- It is a Syntax Error if `CountLeftCapturingParensWithin(Pattern) ≥ 232 - 1`.
- It is a Syntax Error if *Pattern* contains two or more *GroupSpecifiers* for which `CapturingGroupName` of *GroupSpecifier* is the same.

*QuantifierPrefix* :: { *DecimalDigits* , *DecimalDigits* }

- It is a Syntax Error if the MV of the first *DecimalDigits* is strictly greater than the MV of the second *DecimalDigits*.

*AtomEscape* :: **k** *GroupName*

- It is a Syntax Error if `GroupSpecifiersThatMatch(GroupName)` is empty.

*AtomEscape* :: *DecimalEscape*

- It is a Syntax Error if the `CapturingGroupNumber` of *DecimalEscape* is strictly greater than `CountLeftCapturingParensWithin`(the *Pattern* containing *AtomEscape*).

*NonemptyClassRanges* :: *ClassAtom* – *ClassAtom* *ClassRanges*

- It is a Syntax Error if `IsCharacterClass` of the first *ClassAtom* is **true** or `IsCharacterClass` of the second *ClassAtom* is **true**.
- It is a Syntax Error if `IsCharacterClass` of the first *ClassAtom* is **false**, `IsCharacterClass` of the second *ClassAtom* is **false**, and the `CharacterValue` of the first *ClassAtom* is strictly greater than the `CharacterValue` of the second *ClassAtom*.

*NonemptyClassRangesNoDash* :: *ClassAtomNoDash* – *ClassAtom* *ClassRanges*

- It is a Syntax Error if `IsCharacterClass` of *ClassAtomNoDash* is **true** or `IsCharacterClass` of *ClassAtom* is **true**.
- It is a Syntax Error if `IsCharacterClass` of *ClassAtomNoDash* is **false**, `IsCharacterClass` of *ClassAtom* is **false**, and the `CharacterValue` of *ClassAtomNoDash* is strictly greater than the `CharacterValue` of *ClassAtom*.

*RegExpIdentifierStart* :: \ *RegExpUnicodeEscapeSequence*

- It is a Syntax Error if the `CharacterValue` of *RegExpUnicodeEscapeSequence* is not the numeric value of some code point matched by the *IdentifierStartChar* lexical grammar production.

*RegExpIdentifierStart* :: *UnicodeLeadSurrogate* *UnicodeTrailSurrogate*

- It is a Syntax Error if `RegExpIdentifierCodePoint` of *RegExpIdentifierStart* is not matched by the *UnicodeIDStart* lexical grammar production.

*RegExpIdentifierPart* :: \ *RegExpUnicodeEscapeSequence*

- It is a Syntax Error if the `CharacterValue` of *RegExpUnicodeEscapeSequence* is not the numeric value of some code point matched by the *IdentifierPartChar* lexical grammar production.

*RegExpIdentifierPart* :: *UnicodeLeadSurrogate* *UnicodeTrailSurrogate*

- It is a Syntax Error if `RegExpIdentifierCodePoint` of *RegExpIdentifierPart* is not matched by the *UnicodeIDContinue* lexical grammar production.

*UnicodePropertyValueExpression* :: *UnicodePropertyName* = *UnicodePropertyValue*

- It is a Syntax Error if the [source text matched by \*UnicodePropertyName\*](#) is not a Unicode [property name](#) or property alias listed in the “Property name and aliases” column of [Table 65](#).
- It is a Syntax Error if the [source text matched by \*UnicodePropertyValue\*](#) is not a property value or property value alias for the Unicode property or property alias given by the [source text matched by \*UnicodePropertyName\*](#) listed in <https://unicode.org/Public/UCD/latest/ucd/PropertyValueAliases.txt>.

*UnicodePropertyValueExpression* :: *LoneUnicodePropertyNameOrValue*

- It is a Syntax Error if the [source text matched by \*LoneUnicodePropertyNameOrValue\*](#) is not a Unicode property value or property value alias for the General\_Category (gc) property listed in <https://unicode.org/Public/UCD/latest/ucd/PropertyValueAliases.txt>, nor a binary property or binary property alias listed in the “Property name and aliases” column of [Table 66](#).

### 22.2.1.2 Static Semantics: CountLeftCapturingParensWithin ( *node* )

The abstract operation CountLeftCapturingParensWithin takes argument *node* (a [Parse Node](#)) and returns a non-negative [integer](#). It returns the number of left-capturing parentheses in *node*. A *left-capturing parenthesis* is any `(` pattern character that is matched by the `(` terminal of the *Atom* :: `( GroupSpecifieropt Disjunction )` production.

NOTE This section is amended in [B.1.2.2](#).

It performs the following steps when called:

1. **Assert:** *node* is an instance of a production in the [RegExp Pattern grammar](#).
2. Return the number of *Atom* :: `( GroupSpecifieropt Disjunction )` [Parse Nodes](#) contained within *node*.

### 22.2.1.3 Static Semantics: CountLeftCapturingParensBefore ( *node* )

The abstract operation CountLeftCapturingParensBefore takes argument *node* (a [Parse Node](#)) and returns a non-negative [integer](#). It returns the number of [left-capturing parentheses](#) within the enclosing pattern that occur to the left of *node*.

NOTE This section is amended in [B.1.2.2](#).

It performs the following steps when called:

1. **Assert:** *node* is an instance of a production in the [RegExp Pattern grammar](#).
2. Let *pattern* be the *Pattern* containing *node*.
3. Return the number of *Atom* :: `( GroupSpecifieropt Disjunction )` [Parse Nodes](#) contained within *pattern* that either occur before *node* or contain *node*.

### 22.2.1.4 Static Semantics: CapturingGroupNumber

The [syntax-directed operation](#) CapturingGroupNumber takes no arguments and returns a positive [integer](#).

NOTE This section is amended in [B.1.2.1](#).

It is defined piecewise over the following productions:

*DecimalEscape* :: *NonZeroDigit*

1. Return the MV of *NonZeroDigit*.

*DecimalEscape* :: *NonZeroDigit DecimalDigits*

1. Let *n* be the number of code points in *DecimalDigits*.
2. Return (the MV of *NonZeroDigit* × 10<sup>*n*</sup> plus the MV of *DecimalDigits*).

The definitions of “the MV of *NonZeroDigit*” and “the MV of *DecimalDigits*” are in [12.9.3](#).

### 22.2.1.5 Static Semantics: *IsCharacterClass*

The [syntax-directed operation](#) *IsCharacterClass* takes no arguments and returns a Boolean.

**NOTE** This section is amended in [B.1.2.3](#).

It is defined piecewise over the following productions:

*ClassAtom* ::

–

*ClassAtomNoDash* ::

*SourceCharacter* but not one of \ or ] or –

*ClassEscape* ::

**b**

–

*CharacterEscape*

1. Return **false**.

*ClassEscape* :: *CharacterClassEscape*

1. Return **true**.

### 22.2.1.6 Static Semantics: *CharacterValue*

The [syntax-directed operation](#) *CharacterValue* takes no arguments and returns a non-negative [integer](#).

**NOTE 1** This section is amended in [B.1.2.4](#).

It is defined piecewise over the following productions:

*ClassAtom* :: –

1. Return the numeric value of U+002D (HYPHEN-MINUS).

*ClassAtomNoDash* :: *SourceCharacter* but not one of \ or ] or –

1. Let *ch* be the code point matched by *SourceCharacter*.
2. Return the numeric value of *ch*.

*ClassEscape* :: **b**

1. Return the numeric value of U+0008 (BACKSPACE).

*ClassEscape* :: –

1. Return the numeric value of U+002D (HYPHEN-MINUS).

*CharacterEscape* :: *ControlEscape*

1. Return the numeric value according to [Table 63](#).

**Table 63: ControlEscape Code Point Values**

ControlEscape	Numeric Value	Code Point	Unicode Name	Symbol
<b>t</b>	9	<b>U+0009</b>	CHARACTER TABULATION	<HT>
<b>n</b>	10	<b>U+000A</b>	LINE FEED (LF)	<LF>
<b>v</b>	11	<b>U+000B</b>	LINE TABULATION	<VT>
<b>f</b>	12	<b>U+000C</b>	FORM FEED (FF)	<FF>
<b>r</b>	13	<b>U+000D</b>	CARRIAGE RETURN (CR)	<CR>

*CharacterEscape* :: **c** *AsciiLetter*

1. Let *ch* be the code point matched by *AsciiLetter*.
2. Let *i* be the numeric value of *ch*.
3. Return the remainder of dividing *i* by 32.

*CharacterEscape* :: **0** [lookahead  $\notin$  *DecimalDigit*]

1. Return the numeric value of U+0000 (NULL).

**NOTE 2** `\0` represents the <NUL> character and cannot be followed by a decimal digit.

*CharacterEscape* :: *HexEscapeSequence*

1. Return the MV of *HexEscapeSequence*.

*RegExpUnicodeEscapeSequence* :: **u** *HexLeadSurrogate* \ **u** *HexTrailSurrogate*

1. Let *lead* be the [CharacterValue](#) of *HexLeadSurrogate*.
2. Let *trail* be the [CharacterValue](#) of *HexTrailSurrogate*.
3. Let *cp* be [UTF16SurrogatePairToCodePoint](#)(*lead*, *trail*).
4. Return the numeric value of *cp*.

*RegExpUnicodeEscapeSequence* :: **u** *Hex4Digits*

1. Return the MV of *Hex4Digits*.

*RegExpUnicodeEscapeSequence* :: **u**{ *CodePoint* }

1. Return the MV of *CodePoint*.

*HexLeadSurrogate* :: *Hex4Digits*

*HexTrailSurrogate* :: *Hex4Digits*

*HexNonSurrogate* :: *Hex4Digits*

1. Return the MV of *Hex4Digits*.

*CharacterEscape* :: *IdentityEscape*



1. Let *ch* be the code point matched by *IdentityEscape*.
2. Return the numeric value of *ch*.

### 22.2.1.7 Static Semantics: GroupSpecifiersThatMatch ( *thisGroupName* )

The abstract operation *GroupSpecifiersThatMatch* takes argument *thisGroupName* (a *GroupName Parse Node*) and returns a *List* of *GroupSpecifier Parse Nodes*. It performs the following steps when called:

1. Let *name* be the *CapturingGroupName* of *thisGroupName*.
2. Let *pattern* be the *Pattern* containing *thisGroupName*.
3. Let *result* be a new empty *List*.
4. For each *GroupSpecifier gs* that *pattern* contains, do
  - a. If the *CapturingGroupName* of *gs* is *name*, then
    - i. Append *gs* to *result*.
5. Return *result*.

### 22.2.1.8 Static Semantics: CapturingGroupName

The *syntax-directed operation* *CapturingGroupName* takes no arguments and returns a *String*. It is defined piecewise over the following productions:

*GroupName* :: < *RegExpIdentifierName* >

1. Let *idTextUnescaped* be *RegExpIdentifierCodePoints* of *RegExpIdentifierName*.
2. Return *CodePointsToString(idTextUnescaped)*.

### 22.2.1.9 Static Semantics: RegExpIdentifierCodePoints

The *syntax-directed operation* *RegExpIdentifierCodePoints* takes no arguments and returns a *List* of code points. It is defined piecewise over the following productions:

*RegExpIdentifierName* :: *RegExpIdentifierStart*

1. Let *cp* be *RegExpIdentifierCodePoint* of *RegExpIdentifierStart*.
2. Return « *cp* ».

*RegExpIdentifierName* :: *RegExpIdentifierName* *RegExpIdentifierPart*

1. Let *cps* be *RegExpIdentifierCodePoints* of the derived *RegExpIdentifierName*.
2. Let *cp* be *RegExpIdentifierCodePoint* of *RegExpIdentifierPart*.
3. Return the *list-concatenation* of *cps* and « *cp* ».

### 22.2.1.10 Static Semantics: RegExpIdentifierCodePoint

The *syntax-directed operation* *RegExpIdentifierCodePoint* takes no arguments and returns a code point. It is defined piecewise over the following productions:

*RegExpIdentifierStart* :: *IdentifierStartChar*

1. Return the code point matched by *IdentifierStartChar*.

*RegExpIdentifierPart* :: *IdentifierPartChar*

1. Return the code point matched by *IdentifierPartChar*.

*RegExpIdentifierStart* :: \ *RegExpUnicodeEscapeSequence*  
*RegExpIdentifierPart* :: \ *RegExpUnicodeEscapeSequence*

1. Return the code point whose numeric value is the [CharacterValue](#) of *RegExpUnicodeEscapeSequence*.

*RegExpIdentifierStart* :: *UnicodeLeadSurrogate UnicodeTrailSurrogate*  
*RegExpIdentifierPart* :: *UnicodeLeadSurrogate UnicodeTrailSurrogate*

1. Let *lead* be the code unit whose numeric value is the numeric value of the code point matched by *UnicodeLeadSurrogate*.
2. Let *trail* be the code unit whose numeric value is the numeric value of the code point matched by *UnicodeTrailSurrogate*.
3. Return [UTF16SurrogatePairToCodePoint](#)(*lead*, *trail*).

## 22.2.2 Pattern Semantics

A regular expression pattern is converted into an [Abstract Closure](#) using the process described below. An implementation is encouraged to use more efficient algorithms than the ones listed below, as long as the results are the same. The [Abstract Closure](#) is used as the value of a `RegExp` object's `[[RegExpMatcher]]` internal slot.

A *Pattern* is either a BMP pattern or a Unicode pattern depending upon whether or not its associated flags contain a `u`. A BMP pattern matches against a `String` interpreted as consisting of a sequence of 16-bit values that are Unicode code points in the range of the Basic Multilingual Plane. A Unicode pattern matches against a `String` interpreted as consisting of Unicode code points encoded using UTF-16. In the context of describing the behaviour of a BMP pattern “character” means a single 16-bit Unicode BMP code point. In the context of describing the behaviour of a Unicode pattern “character” means a UTF-16 encoded code point (6.1.4). In either context, “character value” means the numeric value of the corresponding non-encoded code point.

The syntax and semantics of *Pattern* is defined as if the source text for the *Pattern* was a [List](#) of *SourceCharacter* values where each *SourceCharacter* corresponds to a Unicode code point. If a BMP pattern contains a non-BMP *SourceCharacter* the entire pattern is encoded using UTF-16 and the individual code units of that encoding are used as the elements of the [List](#).

**NOTE** For example, consider a pattern expressed in source text as the single non-BMP character U+1D11E (MUSICAL SYMBOL G CLEF). Interpreted as a Unicode pattern, it would be a single element (character) [List](#) consisting of the single code point U+1D11E. However, interpreted as a BMP pattern, it is first UTF-16 encoded to produce a two element [List](#) consisting of the code units 0xD834 and 0xDD1E.

Patterns are passed to the `RegExp` [constructor](#) as ECMAScript `String` values in which non-BMP characters are UTF-16 encoded. For example, the single character MUSICAL SYMBOL G CLEF pattern, expressed as a `String` value, is a `String` of length 2 whose elements were the code units 0xD834 and 0xDD1E. So no further translation of the string would be necessary to process it as a BMP pattern consisting of two pattern characters. However, to process it as a Unicode pattern [UTF16SurrogatePairToCodePoint](#) must be used in producing a [List](#) whose sole element is a single pattern character, the code point U+1D11E.

An implementation may not actually perform such translations to or from UTF-16, but the semantics of this specification requires that the result of pattern matching be as if such translations were performed.

### 22.2.2.1 Notation

The descriptions below use the following internal data structures:

- A *CharSet* is a mathematical set of characters. In the context of a Unicode pattern, “all characters” means the *CharSet* containing all code point values; otherwise “all characters” means the *CharSet* containing all code unit values.
- A *CaptureRange* is an ordered pair (*startIndex*, *endIndex*) that represents the range of characters included in a capture, where *startIndex* is an *integer* representing the start index (inclusive) of the range within *Input*, and *endIndex* is an *integer* representing the end index (exclusive) of the range within *Input*. For any *CaptureRange*, these indices must satisfy the invariant that  $startIndex \leq endIndex$ .
- A *MatchState* is an ordered triple (*input*, *endIndex*, *captures*) where *input* is a *List* of characters representing the String being matched, *endIndex* is an *integer*, and *captures* is a *List* of values, one for each *left-capturing parenthesis* in the pattern. States are used to represent partial match states in the regular expression matching algorithms. The *endIndex* is one plus the index of the last input character matched so far by the pattern, while *captures* holds the results of capturing parentheses. The  $n^{\text{th}}$  element of *captures* is either a *CaptureRange* representing the range of characters captured by the  $n^{\text{th}}$  set of capturing parentheses, or **undefined** if the  $n^{\text{th}}$  set of capturing parentheses hasn't been reached yet. Due to backtracking, many States may be in use at any time during the matching process.
- A *MatchResult* is either a *MatchState* or the special token failure that indicates that the match failed.
- A *MatcherContinuation* is an *Abstract Closure* that takes one *MatchState* argument and returns a *MatchResult* result. The *MatcherContinuation* attempts to match the remaining portion (specified by the closure's captured values) of the pattern against *Input*, starting at the intermediate state given by its *MatchState* argument. If the match succeeds, the *MatcherContinuation* returns the final *MatchState* that it reached; if the match fails, the *MatcherContinuation* returns failure.
- A *Matcher* is an *Abstract Closure* that takes two arguments—a *MatchState* and a *MatcherContinuation*—and returns a *MatchResult* result. A *Matcher* attempts to match a middle subpattern (specified by the closure's captured values) of the pattern against the *MatchState*'s *input*, starting at the intermediate state given by its *MatchState* argument. The *MatcherContinuation* argument should be a closure that matches the rest of the pattern. After matching the subpattern of a pattern to obtain a new *MatchState*, the *Matcher* then calls *MatcherContinuation* on that new *MatchState* to test if the rest of the pattern can match as well. If it can, the *Matcher* returns the *MatchState* returned by *MatcherContinuation*; if not, the *Matcher* may try different choices at its choice points, repeatedly calling *MatcherContinuation* until it either succeeds or all possibilities have been exhausted.

#### 22.2.2.1.1 RegExp Records

A *RegExp Record* is a *Record* value used to store information about a RegExp that is needed during compilation and possibly during matching.

It has the following fields:

Table 64: **RegExp Record Fields**

Field Name	Value	Meaning
[[IgnoreCase]]	a Boolean	indicates whether "i" appears in the RegExp's flags
[[Multiline]]	a Boolean	indicates whether "m" appears in the RegExp's flags
[[DotAll]]	a Boolean	indicates whether "s" appears in the RegExp's flags
[[Unicode]]	a Boolean	indicates whether "u" appears in the RegExp's flags
[[CapturingGroupsCount]]	a non-negative integer	the number of <i>left-capturing parentheses</i> in the RegExp's pattern

### 22.2.2.2 Runtime Semantics: CompilePattern

The [syntax-directed operation](#) `CompilePattern` takes argument *rer* (a [RegExp Record](#)) and returns an [Abstract Closure](#) that takes a [List](#) of characters and a non-negative [integer](#) and returns a [MatchResult](#). It is defined piecewise over the following productions:

*Pattern* :: *Disjunction*

1. Let *m* be [CompileSubpattern](#) of *Disjunction* with arguments *rer* and forward.
2. Return a new [Abstract Closure](#) with parameters (*Input*, *index*) that captures *rer* and *m* and performs the following steps when called:
  - a. [Assert](#): *Input* is a [List](#) of characters.
  - b. [Assert](#):  $0 \leq \textit{index} \leq$  the number of elements in *Input*.
  - c. Let *c* be a new [MatcherContinuation](#) with parameters (*y*) that captures nothing and performs the following steps when called:
    - i. [Assert](#): *y* is a [MatchState](#).
    - ii. Return *y*.
  - d. Let *cap* be a [List](#) of *rer*.[[CapturingGroupsCount]] **undefined** values, indexed 1 through *rer*.[[CapturingGroupsCount]].
  - e. Let *x* be the [MatchState](#) (*Input*, *index*, *cap*).
  - f. Return *m*(*x*, *c*).

**NOTE** A [Pattern](#) compiles to an [Abstract Closure](#) value. [RegExpBuiltinExec](#) can then apply this procedure to a [List](#) of characters and an offset within that [List](#) to determine whether the pattern would match starting at exactly that offset within the [List](#), and, if it does match, what the values of the capturing parentheses would be. The algorithms in 22.2.2 are designed so that compiling a pattern may throw a **SyntaxError** exception; on the other hand, once the pattern is successfully compiled, applying the resulting [Abstract Closure](#) to find a match in a [List](#) of characters cannot throw an exception (except for any [implementation-defined](#) exceptions that can occur anywhere such as out-of-memory).

### 22.2.2.3 Runtime Semantics: CompileSubpattern

The [syntax-directed operation](#) `CompileSubpattern` takes arguments *rer* (a [RegExp Record](#)) and *direction* (forward or backward) and returns a [Matcher](#).

**NOTE 1** This section is amended in [B.1.2.5](#).

It is defined piecewise over the following productions:

*Disjunction* :: *Alternative* | *Disjunction*

1. Let *m1* be [CompileSubpattern](#) of *Alternative* with arguments *rer* and *direction*.
2. Let *m2* be [CompileSubpattern](#) of *Disjunction* with arguments *rer* and *direction*.
3. Return a new [Matcher](#) with parameters (*x*, *c*) that captures *m1* and *m2* and performs the following steps when called:
  - a. [Assert](#): *x* is a [MatchState](#).
  - b. [Assert](#): *c* is a [MatcherContinuation](#).
  - c. Let *r* be *m1*(*x*, *c*).
  - d. If *r* is not failure, return *r*.
  - e. Return *m2*(*x*, *c*).

NOTE 2 The | regular expression operator separates two alternatives. The pattern first tries to match the left *Alternative* (followed by the sequel of the regular expression); if it fails, it tries to match the right *Disjunction* (followed by the sequel of the regular expression). If the left *Alternative*, the right *Disjunction*, and the sequel all have choice points, all choices in the sequel are tried before moving on to the next choice in the left *Alternative*. If choices in the left *Alternative* are exhausted, the right *Disjunction* is tried instead of the left *Alternative*. Any capturing parentheses inside a portion of the pattern skipped by | produce **undefined** values instead of Strings. Thus, for example,

```
/a|ab/.exec("abc")
```

returns the result "a" and not "ab". Moreover,

```
/((a)|(ab))((c)|(bc))/.exec("abc")
```

returns the array

```
["abc", "a", "a", undefined, "bc", undefined, "bc"]
```

and not

```
["abc", "ab", undefined, "ab", "c", "c", undefined]
```

The order in which the two alternatives are tried is independent of the value of *direction*.

*Alternative* :: [empty]

1. Return a new *Matcher* with parameters (*x*, *c*) that captures nothing and performs the following steps when called:
  - a. Assert: *x* is a *MatchState*.
  - b. Assert: *c* is a *MatcherContinuation*.
  - c. Return *c*(*x*).

*Alternative* :: *Alternative Term*

1. Let *m1* be *CompileSubpattern* of *Alternative* with arguments *rer* and *direction*.
2. Let *m2* be *CompileSubpattern* of *Term* with arguments *rer* and *direction*.
3. If *direction* is forward, then
  - a. Return a new *Matcher* with parameters (*x*, *c*) that captures *m1* and *m2* and performs the following steps when called:
    - i. Assert: *x* is a *MatchState*.
    - ii. Assert: *c* is a *MatcherContinuation*.
    - iii. Let *d* be a new *MatcherContinuation* with parameters (*y*) that captures *c* and *m2* and performs the following steps when called:
      1. Assert: *y* is a *MatchState*.
      2. Return *m2*(*y*, *c*).
    - iv. Return *m1*(*x*, *d*).
4. Else,
  - a. Assert: *direction* is backward.
  - b. Return a new *Matcher* with parameters (*x*, *c*) that captures *m1* and *m2* and performs the following steps when called:
    - i. Assert: *x* is a *MatchState*.
    - ii. Assert: *c* is a *MatcherContinuation*.
    - iii. Let *d* be a new *MatcherContinuation* with parameters (*y*) that captures *c* and *m1* and performs the following steps when called:

1. Assert:  $y$  is a `MatchState`.
2. Return  $m1(y, c)$ .
- iv. Return  $m2(x, d)$ .

**NOTE 3** Consecutive *Terms* try to simultaneously match consecutive portions of *Input*. When *direction* is forward, if the left *Alternative*, the right *Term*, and the sequel of the regular expression all have choice points, all choices in the sequel are tried before moving on to the next choice in the right *Term*, and all choices in the right *Term* are tried before moving on to the next choice in the left *Alternative*. When *direction* is backward, the evaluation order of *Alternative* and *Term* are reversed.

*Term* :: *Assertion*

1. Return `CompileAssertion` of *Assertion* with argument *rer*.

**NOTE 4** The resulting `Matcher` is independent of *direction*.

*Term* :: *Atom*

1. Return `CompileAtom` of *Atom* with arguments *rer* and *direction*.

*Term* :: *Atom Quantifier*

1. Let  $m$  be `CompileAtom` of *Atom* with arguments *rer* and *direction*.
2. Let  $q$  be `CompileQuantifier` of *Quantifier*.
3. Assert:  $q.[[Min]] \leq q.[[Max]]$ .
4. Let *parenIndex* be `CountLeftCapturingParensBefore`(*Term*).
5. Let *parenCount* be `CountLeftCapturingParensWithin`(*Atom*).
6. Return a new `Matcher` with parameters ( $x, c$ ) that captures  $m, q, \textit{parenIndex}$ , and *parenCount* and performs the following steps when called:
  - a. Assert:  $x$  is a `MatchState`.
  - b. Assert:  $c$  is a `MatcherContinuation`.
  - c. Return `RepeatMatcher`( $m, q.[[Min]], q.[[Max]], q.[[Greedy]], x, c, \textit{parenIndex}, \textit{parenCount}$ ).

#### 22.2.2.3.1 RepeatMatcher ( $m, \textit{min}, \textit{max}, \textit{greedy}, x, c, \textit{parenIndex}, \textit{parenCount}$ )

The abstract operation `RepeatMatcher` takes arguments  $m$  (a `Matcher`), *min* (a non-negative `integer`), *max* (a non-negative `integer` or  $+\infty$ ), *greedy* (a Boolean),  $x$  (a `MatchState`),  $c$  (a `MatcherContinuation`), *parenIndex* (a non-negative `integer`), and *parenCount* (a non-negative `integer`) and returns a `MatchResult`. It performs the following steps when called:

1. If  $\textit{max} = 0$ , return  $c(x)$ .
2. Let  $d$  be a new `MatcherContinuation` with parameters ( $y$ ) that captures  $m, \textit{min}, \textit{max}, \textit{greedy}, x, c, \textit{parenIndex}$ , and *parenCount* and performs the following steps when called:
  - a. Assert:  $y$  is a `MatchState`.
  - b. If  $\textit{min} = 0$  and  $y$ 's *endIndex* =  $x$ 's *endIndex*, return failure.
  - c. If  $\textit{min} = 0$ , let  $\textit{min2}$  be 0; otherwise let  $\textit{min2}$  be  $\textit{min} - 1$ .
  - d. If  $\textit{max} = +\infty$ , let  $\textit{max2}$  be  $+\infty$ ; otherwise let  $\textit{max2}$  be  $\textit{max} - 1$ .
  - e. Return `RepeatMatcher`( $m, \textit{min2}, \textit{max2}, \textit{greedy}, y, c, \textit{parenIndex}, \textit{parenCount}$ ).
3. Let *cap* be a copy of  $x$ 's *captures List*.
4. For each `integer`  $k$  in the inclusive interval from  $\textit{parenIndex} + 1$  to  $\textit{parenIndex} + \textit{parenCount}$ , set  $\textit{cap}[k]$  to **undefined**.
5. Let *Input* be  $x$ 's *input*.
6. Let  $e$  be  $x$ 's *endIndex*.

7. Let *xr* be the *MatchState* (*Input*, *e*, *cap*).
8. If *min* ≠ 0, return *m(xr, d)*.
9. If *greedy* is **false**, then
  - a. Let *z* be *c(x)*.
  - b. If *z* is not failure, return *z*.
  - c. Return *m(xr, d)*.
10. Let *z* be *m(xr, d)*.
11. If *z* is not failure, return *z*.
12. Return *c(x)*.

NOTE 1 An *Atom* followed by a *Quantifier* is repeated the number of times specified by the *Quantifier*. A *Quantifier* can be non-greedy, in which case the *Atom* pattern is repeated as few times as possible while still matching the sequel, or it can be greedy, in which case the *Atom* pattern is repeated as many times as possible while still matching the sequel. The *Atom* pattern is repeated rather than the input character sequence that it matches, so different repetitions of the *Atom* can match different input substrings.

NOTE 2 If the *Atom* and the sequel of the regular expression all have choice points, the *Atom* is first matched as many (or as few, if non-greedy) times as possible. All choices in the sequel are tried before moving on to the next choice in the last repetition of *Atom*. All choices in the last (*n*<sup>th</sup>) repetition of *Atom* are tried before moving on to the next choice in the next-to-last (*n* - 1)<sup>st</sup> repetition of *Atom*; at which point it may turn out that more or fewer repetitions of *Atom* are now possible; these are exhausted (again, starting with either as few or as many as possible) before moving on to the next choice in the (*n* - 1)<sup>st</sup> repetition of *Atom* and so on.

Compare

```
/a[a-z]{2,4}/.exec("abcdefghi")
```

which returns "abcde" with

```
/a[a-z]{2,4}?/.exec("abcdefghi")
```

which returns "abc".

Consider also

```
/(a|aabaac|ba|b|c)*/.exec("aabaac")
```

which, by the choice point ordering above, returns the array

```
["aaba", "ba"]
```

and not any of:

```
["aabaac", "aabaac"]
["aabaac", "c"]
```

The above ordering of choice points can be used to write a regular expression that calculates the greatest common divisor of two numbers (represented in unary notation). The following example calculates the gcd of 10 and 15:

```
"aaaaaaaaaa,aaaaaaaaaaaaaaaa".replace(/^(a+)\1*,\1+$/, "$1")
```

which returns the gcd in unary notation "aaaaa".

NOTE 3 Step 4 of the RepeatMatcher clears *Atom*'s captures each time *Atom* is repeated. We can see its behaviour in the regular expression

```
/(z)((a+)?(b+)?(c))*/.exec("zaacbbbcac")
```

which returns the array

```
["zaacbbbcac", "z", "ac", "a", undefined, "c"]
```

and not

```
["zaacbbbcac", "z", "ac", "a", "bbb", "c"]
```

because each iteration of the outermost *\** clears all captured Strings contained in the quantified *Atom*, which in this case includes capture Strings numbered 2, 3, 4, and 5.

NOTE 4 Step 2.b of the RepeatMatcher states that once the minimum number of repetitions has been satisfied, any more expansions of *Atom* that match the empty character sequence are not considered for further repetitions. This prevents the regular expression engine from falling into an infinite loop on patterns such as:

```
/(a*)*/.exec("b")
```

or the slightly more complicated:

```
/(a*)b\1+/.exec("baaaac")
```

which returns the array

```
["b", ""]
```

#### 22.2.2.4 Runtime Semantics: CompileAssertion

The [syntax-directed operation](#) `CompileAssertion` takes argument *rer* (a [RegExp Record](#)) and returns a [Matcher](#).

NOTE 1 This section is amended in [B.1.2.6](#).

It is defined piecewise over the following productions:

*Assertion* ::  $\wedge$

1. Return a new [Matcher](#) with parameters (*x*, *c*) that captures *rer* and performs the following steps when called:
  - a. **Assert:** *x* is a [MatchState](#).
  - b. **Assert:** *c* is a [MatcherContinuation](#).
  - c. Let *Input* be *x*'s *input*.
  - d. Let *e* be *x*'s *endIndex*.
  - e. If *e* = 0, or if *rer*.[[Multiline](#)] is **true** and the character *Input*[*e* - 1] is matched by *LineTerminator*, then
    - i. Return *c*(*x*).
  - f. Return failure.



NOTE 2 Even when the **y** flag is used with a pattern, **^** always matches only at the beginning of *Input*, or (if *rer*.[[Multiline]] is **true**) at the beginning of a line.

Assertion :: \$

1. Return a new *Matcher* with parameters (*x*, *c*) that captures *rer* and performs the following steps when called:
  - a. Assert: *x* is a *MatchState*.
  - b. Assert: *c* is a *MatcherContinuation*.
  - c. Let *Input* be *x*'s *input*.
  - d. Let *e* be *x*'s *endIndex*.
  - e. Let *InputLength* be the number of elements in *Input*.
  - f. If *e* = *InputLength*, or if *rer*.[[Multiline]] is **true** and the character *Input*[*e*] is matched by *LineTerminator*, then
    - i. Return *c*(*x*).
  - g. Return failure.

Assertion :: \b

1. Return a new *Matcher* with parameters (*x*, *c*) that captures *rer* and performs the following steps when called:
  - a. Assert: *x* is a *MatchState*.
  - b. Assert: *c* is a *MatcherContinuation*.
  - c. Let *Input* be *x*'s *input*.
  - d. Let *e* be *x*'s *endIndex*.
  - e. Let *a* be *IsWordChar*(*rer*, *Input*, *e* - 1).
  - f. Let *b* be *IsWordChar*(*rer*, *Input*, *e*).
  - g. If *a* is **true** and *b* is **false**, or if *a* is **false** and *b* is **true**, return *c*(*x*).
  - h. Return failure.

Assertion :: \B

1. Return a new *Matcher* with parameters (*x*, *c*) that captures *rer* and performs the following steps when called:
  - a. Assert: *x* is a *MatchState*.
  - b. Assert: *c* is a *MatcherContinuation*.
  - c. Let *Input* be *x*'s *input*.
  - d. Let *e* be *x*'s *endIndex*.
  - e. Let *a* be *IsWordChar*(*rer*, *Input*, *e* - 1).
  - f. Let *b* be *IsWordChar*(*rer*, *Input*, *e*).
  - g. If *a* is **true** and *b* is **true**, or if *a* is **false** and *b* is **false**, return *c*(*x*).
  - h. Return failure.

Assertion :: ( ?= Disjunction )

1. Let *m* be *CompileSubpattern* of *Disjunction* with arguments *rer* and forward.
2. Return a new *Matcher* with parameters (*x*, *c*) that captures *m* and performs the following steps when called:
  - a. Assert: *x* is a *MatchState*.
  - b. Assert: *c* is a *MatcherContinuation*.
  - c. Let *d* be a new *MatcherContinuation* with parameters (*y*) that captures nothing and performs the following steps when called:
    - i. Assert: *y* is a *MatchState*.

- ii. Return *y*.
- d. Let *r* be *m(x, d)*.
- e. If *r* is failure, return failure.
- f. Let *y* be *r*'s *MatchState*.
- g. Let *cap* be *y*'s *captures List*.
- h. Let *Input* be *x*'s *input*.
- i. Let *xe* be *x*'s *endIndex*.
- j. Let *z* be the *MatchState* (*Input, xe, cap*).
- k. Return *c(z)*.

NOTE 3 The form `(?= Disjunction )` specifies a zero-width positive lookahead. In order for it to succeed, the pattern inside *Disjunction* must match at the current position, but the current position is not advanced before matching the sequel. If *Disjunction* can match at the current position in several ways, only the first one is tried. Unlike other regular expression operators, there is no backtracking into a `(?=` form (this unusual behaviour is inherited from Perl). This only matters when the *Disjunction* contains capturing parentheses and the sequel of the pattern contains backreferences to those captures.

For example,

```
/(?=(a+))/ .exec("baaabac")
```

matches the empty String immediately after the first **b** and therefore returns the array:

```
["", "aaa"]
```

To illustrate the lack of backtracking into the lookahead, consider:

```
/(?=(a+))a*b\1/.exec("baaabac")
```

This expression returns

```
["aba", "a"]
```

and not:

```
["aaaba", "a"]
```

*Assertion* :: `(?! Disjunction )`

1. Let *m* be *CompileSubpattern* of *Disjunction* with arguments *rer* and forward.
2. Return a new *Matcher* with parameters (*x, c*) that captures *m* and performs the following steps when called:
  - a. *Assert*: *x* is a *MatchState*.
  - b. *Assert*: *c* is a *MatcherContinuation*.
  - c. Let *d* be a new *MatcherContinuation* with parameters (*y*) that captures nothing and performs the following steps when called:
    - i. *Assert*: *y* is a *MatchState*.
    - ii. Return *y*.
  - d. Let *r* be *m(x, d)*.
  - e. If *r* is not failure, return failure.
  - f. Return *c(x)*.

NOTE 4 The form `(?! Disjunction )` specifies a zero-width negative lookahead. In order for it to succeed, the pattern inside *Disjunction* must fail to match at the current position. The current position is not advanced before matching the sequel. *Disjunction* can contain capturing parentheses, but backreferences to them only make sense from within *Disjunction* itself. Backreferences to these capturing parentheses from elsewhere in the pattern always return **undefined** because the negative lookahead must fail for the pattern to succeed. For example,

```
/(. *?)a(?!(a+)b\2c)\2(. *)/.exec("baaabaac")
```

looks for an **a** not immediately followed by some positive number *n* of **a**'s, a **b**, another *n* **a**'s (specified by the first `\2`) and a **c**. The second `\2` is outside the negative lookahead, so it matches against **undefined** and therefore always succeeds. The whole expression returns the array:

```
["baaabaac", "ba", undefined, "abaac"]
```

Assertion :: `(?<= Disjunction )`

1. Let *m* be `CompileSubpattern` of *Disjunction* with arguments *rer* and backward.
2. Return a new `Matcher` with parameters (*x*, *c*) that captures *m* and performs the following steps when called:
  - a. Assert: *x* is a `MatchState`.
  - b. Assert: *c* is a `MatcherContinuation`.
  - c. Let *d* be a new `MatcherContinuation` with parameters (*y*) that captures nothing and performs the following steps when called:
    - i. Assert: *y* is a `MatchState`.
    - ii. Return *y*.
  - d. Let *r* be `m(x, d)`.
  - e. If *r* is failure, return failure.
  - f. Let *y* be *r*'s `MatchState`.
  - g. Let *cap* be *y*'s `captures List`.
  - h. Let *Input* be *x*'s `input`.
  - i. Let *xe* be *x*'s `endIndex`.
  - j. Let *z* be the `MatchState` (*Input*, *xe*, *cap*).
  - k. Return `c(z)`.

Assertion :: `(?! Disjunction )`

1. Let *m* be `CompileSubpattern` of *Disjunction* with arguments *rer* and backward.
2. Return a new `Matcher` with parameters (*x*, *c*) that captures *m* and performs the following steps when called:
  - a. Assert: *x* is a `MatchState`.
  - b. Assert: *c* is a `MatcherContinuation`.
  - c. Let *d* be a new `MatcherContinuation` with parameters (*y*) that captures nothing and performs the following steps when called:
    - i. Assert: *y* is a `MatchState`.
    - ii. Return *y*.
  - d. Let *r* be `m(x, d)`.
  - e. If *r* is not failure, return failure.
  - f. Return `c(x)`.

#### 22.2.2.4.1 IsWordChar ( *rer*, *Input*, *e* )

The abstract operation IsWordChar takes arguments *rer* (a [RegExp Record](#)), *Input* (a [List](#) of characters), and *e* (an [integer](#)) and returns a Boolean. It performs the following steps when called:

1. Let *InputLength* be the number of elements in *Input*.
2. If *e* = -1 or *e* = *InputLength*, return **false**.
3. Let *c* be the character *Input*[ *e* ].
4. If [WordCharacters](#)(*rer*) contains *c*, return **true**.
5. Return **false**.

#### 22.2.2.5 Runtime Semantics: CompileQuantifier

The [syntax-directed operation](#) CompileQuantifier takes no arguments and returns a [Record](#) with fields [\[\[Min\]\]](#) (a non-negative [integer](#)), [\[\[Max\]\]](#) (a non-negative [integer](#) or  $+\infty$ ), and [\[\[Greedy\]\]](#) (a Boolean). It is defined piecewise over the following productions:

*Quantifier* :: *QuantifierPrefix*

1. Let *qp* be [CompileQuantifierPrefix](#) of *QuantifierPrefix*.
2. Return the [Record](#) { [\[\[Min\]\]](#): *qp*.[\[\[Min\]\]](#), [\[\[Max\]\]](#): *qp*.[\[\[Max\]\]](#), [\[\[Greedy\]\]](#): **true** }.

*Quantifier* :: *QuantifierPrefix* ?

1. Let *qp* be [CompileQuantifierPrefix](#) of *QuantifierPrefix*.
2. Return the [Record](#) { [\[\[Min\]\]](#): *qp*.[\[\[Min\]\]](#), [\[\[Max\]\]](#): *qp*.[\[\[Max\]\]](#), [\[\[Greedy\]\]](#): **false** }.

#### 22.2.2.6 Runtime Semantics: CompileQuantifierPrefix

The [syntax-directed operation](#) CompileQuantifierPrefix takes no arguments and returns a [Record](#) with fields [\[\[Min\]\]](#) (a non-negative [integer](#)) and [\[\[Max\]\]](#) (a non-negative [integer](#) or  $+\infty$ ). It is defined piecewise over the following productions:

*QuantifierPrefix* :: \*

1. Return the [Record](#) { [\[\[Min\]\]](#): 0, [\[\[Max\]\]](#):  $+\infty$  }.

*QuantifierPrefix* :: +

1. Return the [Record](#) { [\[\[Min\]\]](#): 1, [\[\[Max\]\]](#):  $+\infty$  }.

*QuantifierPrefix* :: ?

1. Return the [Record](#) { [\[\[Min\]\]](#): 0, [\[\[Max\]\]](#): 1 }.

*QuantifierPrefix* :: { *DecimalDigits* }

1. Let *i* be the MV of *DecimalDigits* (see [12.9.3](#)).
2. Return the [Record](#) { [\[\[Min\]\]](#): *i*, [\[\[Max\]\]](#): *i* }.

*QuantifierPrefix* :: { *DecimalDigits* , }

1. Let *i* be the MV of *DecimalDigits*.
2. Return the [Record](#) { [\[\[Min\]\]](#): *i*, [\[\[Max\]\]](#):  $+\infty$  }.

*QuantifierPrefix* :: { *DecimalDigits* , *DecimalDigits* }

1. Let *i* be the MV of the first *DecimalDigits*.
2. Let *j* be the MV of the second *DecimalDigits*.
3. Return the **Record** { **[[Min]]**: *i*, **[[Max]]**: *j* }.

### 22.2.2.7 Runtime Semantics: CompileAtom

The **syntax-directed operation** `CompileAtom` takes arguments *rer* (a **RegExp Record**) and *direction* (forward or backward) and returns a **Matcher**.

**NOTE 1** This section is amended in [B.1.2.7](#).

It is defined piecewise over the following productions:

*Atom* :: *PatternCharacter*

1. Let *ch* be the character matched by *PatternCharacter*.
2. Let *A* be a one-element **CharSet** containing the character *ch*.
3. Return **CharacterSetMatcher**(*rer*, *A*, **false**, *direction*).

*Atom* :: `.`

1. Let *A* be the **CharSet** of all characters.
2. If *rer*.**[[DotAll]]** is not **true**, then
  - a. Remove from *A* all characters corresponding to a code point on the right-hand side of the *LineTerminator* production.
3. Return **CharacterSetMatcher**(*rer*, *A*, **false**, *direction*).

*Atom* :: *CharacterClass*

1. Let *cc* be **CompileCharacterClass** of *CharacterClass* with argument *rer*.
2. Return **CharacterSetMatcher**(*rer*, *cc*.**[[CharSet]]**, *cc*.**[[Invert]]**, *direction*).

*Atom* :: ( *GroupSpecifier*<sub>opt</sub> *Disjunction* )

1. Let *m* be **CompileSubpattern** of *Disjunction* with arguments *rer* and *direction*.
2. Let *parenIndex* be **CountLeftCapturingParensBefore**(*Atom*).
3. Return a new **Matcher** with parameters (*x*, *c*) that captures *direction*, *m*, and *parenIndex* and performs the following steps when called:
  - a. **Assert**: *x* is a **MatchState**.
  - b. **Assert**: *c* is a **MatcherContinuation**.
  - c. Let *d* be a new **MatcherContinuation** with parameters (*y*) that captures *x*, *c*, *direction*, and *parenIndex* and performs the following steps when called:
    - i. **Assert**: *y* is a **MatchState**.
    - ii. Let *cap* be a copy of *y*'s **captures List**.
    - iii. Let *input* be *x*'s **input**.
    - iv. Let *xe* be *x*'s **endIndex**.
    - v. Let *ye* be *y*'s **endIndex**.
    - vi. If *direction* is forward, then
      1. **Assert**: *xe* ≤ *ye*.
      2. Let *r* be the **CaptureRange** (*xe*, *ye*).
    - vii. Else,
      1. **Assert**: *direction* is backward.
      2. **Assert**: *ye* ≤ *xe*.

3. Let *r* be the [CaptureRange](#) (*ye*, *xe*).
  - viii. Set *cap*[*parenIndex* + 1] to *r*.
  - ix. Let *z* be the [MatchState](#) (*Input*, *ye*, *cap*).
  - x. Return *c*(*z*).
- d. Return *m*(*x*, *d*).

**NOTE 2** Parentheses of the form ( *Disjunction* ) serve both to group the components of the *Disjunction* pattern together and to save the result of the match. The result can be used either in a backreference ( \ followed by a non-zero decimal number), referenced in a replace String, or returned as part of an array from the regular expression matching [Abstract Closure](#). To inhibit the capturing behaviour of parentheses, use the form (?: *Disjunction* ) instead.

*Atom* :: (?: *Disjunction* )

1. Return [CompileSubpattern](#) of *Disjunction* with arguments *rer* and *direction*.

*AtomEscape* :: *DecimalEscape*

1. Let *n* be the [CapturingGroupNumber](#) of *DecimalEscape*.
2. **Assert:** *n* ≤ *rer*.[[CapturingGroupsCount]].
3. Return [BackreferenceMatcher](#)(*rer*, *n*, *direction*).

**NOTE 3** An escape sequence of the form \ followed by a non-zero decimal number *n* matches the result of the *n*<sup>th</sup> set of capturing parentheses ([22.2.2.1](#)). It is an error if the regular expression has fewer than *n* capturing parentheses. If the regular expression has *n* or more capturing parentheses but the *n*<sup>th</sup> one is **undefined** because it has not captured anything, then the backreference always succeeds.

*AtomEscape* :: *CharacterEscape*

1. Let *cv* be the [CharacterValue](#) of *CharacterEscape*.
2. Let *ch* be the character whose character value is *cv*.
3. Let *A* be a one-element [CharSet](#) containing the character *ch*.
4. Return [CharacterSetMatcher](#)(*rer*, *A*, **false**, *direction*).

*AtomEscape* :: *CharacterClassEscape*

1. Let *A* be [CompileToCharSet](#) of *CharacterClassEscape* with argument *rer*.
2. Return [CharacterSetMatcher](#)(*rer*, *A*, **false**, *direction*).

*AtomEscape* :: **k** *GroupName*

1. Let *matchingGroupSpecifiers* be [GroupSpecifiersThatMatch](#)(*GroupName*).
2. **Assert:** *matchingGroupSpecifiers* contains a single *GroupSpecifier*.
3. Let *groupSpecifier* be the sole element of *matchingGroupSpecifiers*.
4. Let *parenIndex* be [CountLeftCapturingParensBefore](#)(*groupSpecifier*).
5. Return [BackreferenceMatcher](#)(*rer*, *parenIndex*, *direction*).

#### 22.2.2.7.1 [CharacterSetMatcher](#) ( *rer*, *A*, *invert*, *direction* )

The abstract operation [CharacterSetMatcher](#) takes arguments *rer* (a [RegExp Record](#)), *A* (a [CharSet](#)), *invert* (a Boolean), and *direction* (forward or backward) and returns a [Matcher](#). It performs the following steps when called:

1. Return a new *Matcher* with parameters (*x*, *c*) that captures *rer*, *A*, *invert*, and *direction* and performs the following steps when called:
  - a. **Assert**: *x* is a *MatchState*.
  - b. **Assert**: *c* is a *MatcherContinuation*.
  - c. Let *Input* be *x*'s *input*.
  - d. Let *e* be *x*'s *endIndex*.
  - e. If *direction* is forward, let *f* be *e* + 1.
  - f. Else, let *f* be *e* - 1.
  - g. Let *InputLength* be the number of elements in *Input*.
  - h. If *f* < 0 or *f* > *InputLength*, return failure.
  - i. Let *index* be *min*(*e*, *f*).
  - j. Let *ch* be the character *Input*[*index*].
  - k. Let *cc* be *Canonicalize*(*rer*, *ch*).
  - l. If there exists a member *a* of *A* such that *Canonicalize*(*rer*, *a*) is *cc*, let *found* be **true**.  
Otherwise, let *found* be **false**.
  - m. If *invert* is **false** and *found* is **false**, return failure.
  - n. If *invert* is **true** and *found* is **true**, return failure.
  - o. Let *cap* be *x*'s *captures List*.
  - p. Let *y* be the *MatchState* (*Input*, *f*, *cap*).
  - q. Return *c*(*y*).

#### 22.2.2.7.2 BackreferenceMatcher ( *rer*, *n*, *direction* )

The abstract operation BackreferenceMatcher takes arguments *rer* (a *RegExp Record*), *n* (a positive *integer*), and *direction* (forward or backward) and returns a *Matcher*. It performs the following steps when called:

1. **Assert**: *n* ≥ 1.
2. Return a new *Matcher* with parameters (*x*, *c*) that captures *rer*, *n*, and *direction* and performs the following steps when called:
  - a. **Assert**: *x* is a *MatchState*.
  - b. **Assert**: *c* is a *MatcherContinuation*.
  - c. Let *Input* be *x*'s *input*.
  - d. Let *cap* be *x*'s *captures List*.
  - e. Let *r* be *cap*[*n*].
  - f. If *r* is **undefined**, return *c*(*x*).
  - g. Let *e* be *x*'s *endIndex*.
  - h. Let *rs* be *r*'s *startIndex*.
  - i. Let *re* be *r*'s *endIndex*.
  - j. Let *len* be *re* - *rs*.
  - k. If *direction* is forward, let *f* be *e* + *len*.
  - l. Else, let *f* be *e* - *len*.
  - m. Let *InputLength* be the number of elements in *Input*.
  - n. If *f* < 0 or *f* > *InputLength*, return failure.
  - o. Let *g* be *min*(*e*, *f*).
  - p. If there exists an *integer* *i* in the *interval* from 0 (inclusive) to *len* (exclusive) such that *Canonicalize*(*rer*, *Input*[*rs* + *i*]) is not *Canonicalize*(*rer*, *Input*[*g* + *i*]), return failure.
  - q. Let *y* be the *MatchState* (*Input*, *f*, *cap*).
  - r. Return *c*(*y*).

### 22.2.2.7.3 Canonicalize ( *rer*, *ch* )

The abstract operation Canonicalize takes arguments *rer* (a [RegExp Record](#)) and *ch* (a character) and returns a character. It performs the following steps when called:

1. If *rer*.[[Unicode]] is **true** and *rer*.[[IgnoreCase]] is **true**, then
  - a. If the file <https://unicode.org/Public/UCD/latest/ucd/CaseFolding.txt> of the Unicode Character Database provides a simple or common case folding mapping for *ch*, return the result of applying that mapping to *ch*.
  - b. Return *ch*.
2. If *rer*.[[IgnoreCase]] is **false**, return *ch*.
3. **Assert**: *ch* is a UTF-16 code unit.
4. Let *cp* be the code point whose numeric value is the numeric value of *ch*.
5. Let *u* be the result of toUppercase(« *cp* »), according to the Unicode Default Case Conversion algorithm.
6. Let *uStr* be [CodePointsToString](#)(*u*).
7. If the length of *uStr* ≠ 1, return *ch*.
8. Let *cu* be *uStr*'s single code unit element.
9. If the numeric value of *ch* ≥ 128 and the numeric value of *cu* < 128, return *ch*.
10. Return *cu*.

**NOTE** In case-insignificant matches when *rer*.[[Unicode]] is **true**, all characters are implicitly case-folded using the simple mapping provided by the Unicode Standard immediately before they are compared. The simple mapping always maps to a single code point, so it does not map, for example, **ß** (U+00DF LATIN SMALL LETTER SHARP S) to **ss** or **SS**. It may however map code points outside the Basic Latin block to code points within it—for example, **ſ** (U+017F LATIN SMALL LETTER LONG S) case-folds to **s** (U+0073 LATIN SMALL LETTER S) and **K** (U+212A KELVIN SIGN) case-folds to **k** (U+006B LATIN SMALL LETTER K). Strings containing those code points are matched by regular expressions such as `/[a-z]/ui`.

In case-insignificant matches when *rer*.[[Unicode]] is **false**, the mapping is based on Unicode Default Case Conversion algorithm toUppercase rather than toCasefold, which results in some subtle differences. For example, **Ω** (U+2126 OHM SIGN) is mapped by toUppercase to itself but by toCasefold to **ω** (U+03C9 GREEK SMALL LETTER OMEGA) along with **Ω** (U+03A9 GREEK CAPITAL LETTER OMEGA), so `"\u2126"` is matched by `/[ω]/ui` and `/[\u03A9]/ui` but not by `/[Ω]/i` or `/[\u03A9]/i`. Also, no code point outside the Basic Latin block is mapped to a code point within it, so strings such as `"\u017F r"` and `"\u212A K"` are not matched by `/[a-z]/i`.

### 22.2.2.8 Runtime Semantics: CompileCharacterClass

The [syntax-directed operation](#) CompileCharacterClass takes argument *rer* (a [RegExp Record](#)) and returns a [Record](#) with fields [[CharSet]] (a [CharSet](#)) and [[Invert]] (a Boolean). It is defined piecewise over the following productions:

*CharacterClass* :: [ *ClassRanges* ]

1. Let *A* be [CompileToCharSet](#) of *ClassRanges* with argument *rer*.
2. Return the [Record](#) { [[CharSet]]: *A*, [[Invert]]: **false** }.

*CharacterClass* :: [ ^ *ClassRanges* ]

1. Let *A* be [CompileToCharSet](#) of *ClassRanges* with argument *rer*.
2. Return the [Record](#) { [[CharSet]]: *A*, [[Invert]]: **true** }.



### 22.2.2.9 Runtime Semantics: CompileToCharSet

The [syntax-directed operation](#) `CompileToCharSet` takes argument *rer* (a [RegExp Record](#)) and returns a `CharSet`.

NOTE 1 This section is amended in [B.1.2.8](#).

It is defined piecewise over the following productions:

*ClassRanges* :: [empty]

1. Return the empty `CharSet`.

*NonemptyClassRanges* :: *ClassAtom NonemptyClassRangesNoDash*

1. Let *A* be `CompileToCharSet` of *ClassAtom* with argument *rer*.
2. Let *B* be `CompileToCharSet` of *NonemptyClassRangesNoDash* with argument *rer*.
3. Return the union of `CharSets` *A* and *B*.

*NonemptyClassRanges* :: *ClassAtom – ClassAtom ClassRanges*

1. Let *A* be `CompileToCharSet` of the first *ClassAtom* with argument *rer*.
2. Let *B* be `CompileToCharSet` of the second *ClassAtom* with argument *rer*.
3. Let *C* be `CompileToCharSet` of *ClassRanges* with argument *rer*.
4. Let *D* be `CharacterRange(A, B)`.
5. Return the union of *D* and *C*.

*NonemptyClassRangesNoDash* :: *ClassAtomNoDash NonemptyClassRangesNoDash*

1. Let *A* be `CompileToCharSet` of *ClassAtomNoDash* with argument *rer*.
2. Let *B* be `CompileToCharSet` of *NonemptyClassRangesNoDash* with argument *rer*.
3. Return the union of `CharSets` *A* and *B*.

*NonemptyClassRangesNoDash* :: *ClassAtomNoDash – ClassAtom ClassRanges*

1. Let *A* be `CompileToCharSet` of *ClassAtomNoDash* with argument *rer*.
2. Let *B* be `CompileToCharSet` of *ClassAtom* with argument *rer*.
3. Let *C* be `CompileToCharSet` of *ClassRanges* with argument *rer*.
4. Let *D* be `CharacterRange(A, B)`.
5. Return the union of *D* and *C*.

NOTE 2 *ClassRanges* can expand into a single *ClassAtom* and/or ranges of two *ClassAtom* separated by dashes. In the latter case the *ClassRanges* includes all characters between the first *ClassAtom* and the second *ClassAtom*, inclusive; an error occurs if either *ClassAtom* does not represent a single character (for example, if one is `\w`) or if the first *ClassAtom*'s character value is strictly greater than the second *ClassAtom*'s character value.

NOTE 3 Even if the pattern ignores case, the case of the two ends of a range is significant in determining which characters belong to the range. Thus, for example, the pattern `/[E-F]/i` matches only the letters `E`, `F`, `e`, and `f`, while the pattern `/[E-f]/i` matches all uppercase and lowercase letters in the Unicode Basic Latin block as well as the symbols `[`, `\`, `]`, `^`, `_`, and ```.

NOTE 4 A `-` character can be treated literally or it can denote a range. It is treated literally if it is the first or last character of *ClassRanges*, the beginning or end limit of a range specification, or immediately follows a range specification.

*ClassAtom* :: `-`

1. Return the [CharSet](#) containing the single character `-` U+002D (HYPHEN-MINUS).

*ClassAtomNoDash* :: *SourceCharacter* but not one of `\` or `]` or `-`

1. Return the [CharSet](#) containing the character matched by *SourceCharacter*.

*ClassEscape* ::

`\b`  
`-`  
*CharacterEscape*

1. Let *cv* be the [CharacterValue](#) of this *ClassEscape*.
2. Let *c* be the character whose character value is *cv*.
3. Return the [CharSet](#) containing the single character *c*.

NOTE 5 A *ClassAtom* can use any of the escape sequences that are allowed in the rest of the regular expression except for `\b`, `\B`, and backreferences. Inside a *CharacterClass*, `\b` means the backspace character, while `\B` and backreferences raise errors. Using a backreference inside a *ClassAtom* causes an error.

*CharacterClassEscape* :: `\d`

1. Return the ten-element [CharSet](#) containing the characters `0`, `1`, `2`, `3`, `4`, `5`, `6`, `7`, `8`, and `9`.

*CharacterClassEscape* :: `\D`

1. Return the [CharSet](#) containing all characters not in the [CharSet](#) returned by *CharacterClassEscape* :: `\d`.

*CharacterClassEscape* :: `\s`

1. Return the [CharSet](#) containing all characters corresponding to a code point on the right-hand side of the *WhiteSpace* or *LineTerminator* productions.

*CharacterClassEscape* :: `\S`

1. Return the [CharSet](#) containing all characters not in the [CharSet](#) returned by *CharacterClassEscape* :: `\s`.

*CharacterClassEscape* :: `\w`

1. Return [WordCharacters](#)(*rer*).

*CharacterClassEscape* :: `\W`

1. Return the [CharSet](#) containing all characters not in the [CharSet](#) returned by *CharacterClassEscape* :: `\w`.

*CharacterClassEscape* :: `\p{ UnicodePropertyValueExpression }`

1. Return the **CharSet** containing all Unicode code points included in **CompileToCharSet** of *UnicodePropertyValueExpression* with argument *rer*.

*CharacterClassEscape* :: **P**{ *UnicodePropertyValueExpression* }

1. Return the **CharSet** containing all Unicode code points not included in **CompileToCharSet** of *UnicodePropertyValueExpression* with argument *rer*.

*UnicodePropertyValueExpression* :: *UnicodePropertyName* = *UnicodePropertyValue*

1. Let *ps* be the source text matched by *UnicodePropertyName*.
2. Let *p* be **UnicodeMatchProperty**(*ps*).
3. **Assert**: *p* is a Unicode property name or property alias listed in the “Property name and aliases” column of **Table 65**.
4. Let *vs* be the source text matched by *UnicodePropertyValue*.
5. Let *v* be **UnicodeMatchPropertyValue**(*p*, *vs*).
6. Return the **CharSet** containing all Unicode code points whose character database definition includes the property *p* with value *v*.

*UnicodePropertyValueExpression* :: *LoneUnicodePropertyNameOrValue*

1. Let *s* be the source text matched by *LoneUnicodePropertyNameOrValue*.
2. If **UnicodeMatchPropertyValue**(**General\_Category**, *s*) is a Unicode property value or property value alias for the **General\_Category** (gc) property listed in <https://unicode.org/Public/UCD/latest/ucd/PropertyValueAliases.txt>, then
  - a. Return the **CharSet** containing all Unicode code points whose character database definition includes the property “General\_Category” with value *s*.
3. Let *p* be **UnicodeMatchProperty**(*s*).
4. **Assert**: *p* is a binary Unicode property or binary property alias listed in the “Property name and aliases” column of **Table 66**.
5. Return the **CharSet** containing all Unicode code points whose character database definition includes the property *p* with value “True”.

#### 22.2.2.9.1 CharacterRange ( *A*, *B* )

The abstract operation **CharacterRange** takes arguments *A* (a **CharSet**) and *B* (a **CharSet**) and returns a **CharSet**. It performs the following steps when called:

1. **Assert**: *A* and *B* each contain exactly one character.
2. Let *a* be the one character in **CharSet** *A*.
3. Let *b* be the one character in **CharSet** *B*.
4. Let *i* be the character value of character *a*.
5. Let *j* be the character value of character *b*.
6. **Assert**:  $i \leq j$ .
7. Return the **CharSet** containing all characters with a character value in the inclusive interval from *i* to *j*.

#### 22.2.2.9.2 WordCharacters ( *rer* )

The abstract operation **WordCharacters** takes argument *rer* (a **RegExp Record**) and returns a **CharSet**. Returns a **CharSet** containing the characters considered “word characters” for the purposes of **\b**, **\B**, **\w**, and **\W**. It performs the following steps when called:

1. Let *basicWordChars* be the *CharSet* containing every character in the *ASCII word characters*.
2. Let *extraWordChars* be the *CharSet* containing all characters *c* such that *c* is not in *basicWordChars* but *Canonicalize(*rer*, c)* is in *basicWordChars*.
3. *Assert*: *extraWordChars* is empty unless *rer*.*[[Unicode]]* is **true** and *rer*.*[[IgnoreCase]]* is **true**.
4. Return the union of *basicWordChars* and *extraWordChars*.

### 22.2.2.9.3 UnicodeMatchProperty ( *p* )

The abstract operation *UnicodeMatchProperty* takes argument *p* (*ECMAScript source text*) and returns a Unicode *property name*. It performs the following steps when called:

1. *Assert*: *p* is a Unicode property name or property alias listed in the “Property name and aliases” column of [Table 65](#) or [Table 66](#).
2. Let *c* be the canonical property name of *p* as given in the “Canonical property name” column of the corresponding row.
3. Return the *List* of Unicode code points *c*.

Implementations must support the Unicode property names and aliases listed in [Table 65](#) and [Table 66](#). To ensure interoperability, implementations must not support any other property names or aliases.

**NOTE 1** For example, **Script\_Extensions** (*property name*) and **scx** (*property alias*) are valid, but **script\_extensions** or **Scx** aren't.

**NOTE 2** The listed properties form a superset of what [UTS18 RL1.2](#) requires.

**NOTE 3** The spellings of entries in these tables (including casing) match the spellings used in the file <https://unicode.org/Public/UCD/latest/ucd/PropertyAliases.txt> in the Unicode Character Database. The precise spellings in that file are *guaranteed to be stable*.

**Table 65: Non-binary Unicode property aliases and their canonical property names**

Property name and aliases	Canonical property name
General_Category	General_Category
gc	
Script	Script
sc	
Script_Extensions	Script_Extensions
scx	

Table 66: Binary Unicode property aliases and their canonical property names

Property name and aliases	Canonical property name
ASCII	ASCII
ASCII_Hex_Digit	ASCII_Hex_Digit
AHex	
Alphabetic	Alphabetic
Alpha	
Any	Any
Assigned	Assigned
Bidi_Control	Bidi_Control
Bidi_C	
Bidi_Mirrored	Bidi_Mirrored
Bidi_M	
Case_Ignorable	Case_Ignorable
CI	
Cased	Cased
Changes_When_Casefolded	Changes_When_Casefolded
CWCF	
Changes_When_Casemapped	Changes_When_Casemapped
CWCM	
Changes_When_Lowercased	Changes_When_Lowercased
CWL	
Changes_When_NFKC_Casefolded	Changes_When_NFKC_Casefolded
CWKCF	
Changes_When_Titlecased	Changes_When_Titlecased
CWT	
Changes_When_Uppercased	Changes_When_Uppercased
CWU	
Dash	Dash
Default_Ignorable_Code_Point	Default_Ignorable_Code_Point
DI	
Deprecated	Deprecated
Dep	
Diacritic	Diacritic
Dia	
Emoji	Emoji
Emoji_Component	Emoji_Component
EComp	

Table 66 (continued)

Property name and aliases	Canonical property name
Emoji_Modifier	Emoji_Modifier
EMod	
Emoji_Modifier_Base	Emoji_Modifier_Base
EBase	
Emoji_Presentation	Emoji_Presentation
EPres	
Extended_Pictographic	Extended_Pictographic
ExtPict	
Extender	Extender
Ext	
Grapheme_Base	Grapheme_Base
Gr_Base	
Grapheme_Extend	Grapheme_Extend
Gr_Ext	
Hex_Digit	Hex_Digit
Hex	
IDS_Binary_Operator	IDS_Binary_Operator
IDSB	
IDS_Tertiary_Operator	IDS_Tertiary_Operator
IDST	
ID_Continue	ID_Continue
IDC	
ID_Start	ID_Start
IDS	
Ideographic	Ideographic
Ideo	
Join_Control	Join_Control
Join_C	
Logical_Order_Exception	Logical_Order_Exception
LOE	
Lowercase	Lowercase
Lower	
Math	Math

Table 66 (continued)

Property name and aliases	Canonical property name
Noncharacter_Code_Point	Noncharacter_Code_Point
NChar	
Pattern_Syntax	Pattern_Syntax
Pat_Syn	
Pattern_White_Space	Pattern_White_Space
Pat_WS	
Quotation_Mark	Quotation_Mark
QMark	
Radical	Radical
Regional_Indicator	Regional_Indicator
RI	
Sentence_Terminal	Sentence_Terminal
STerm	
Soft_Dotted	Soft_Dotted
SD	
Terminal_Punctuation	Terminal_Punctuation
Term	
Unified_Ideograph	Unified_Ideograph
UIdeo	
Uppercase	Uppercase
Upper	
Variation_Selector	Variation_Selector
VS	
White_Space	White_Space
space	
XID_Continue	XID_Continue
XIDC	
XID_Start	XID_Start
XIDS	

#### 22.2.2.9.4 UnicodeMatchPropertyValue ( *p*, *v* )

The abstract operation UnicodeMatchPropertyValue takes arguments *p* (ECMAScript source text) and *v* (ECMAScript source text) and returns a Unicode property value. It performs the following steps when called:

1. **Assert:** *p* is a canonical, unaliased Unicode [property name](#) listed in the “Canonical [property name](#)” column of [Table 65](#).
2. **Assert:** *v* is a property value or property value alias for the Unicode property *p* listed in <https://unicode.org/Public/UCD/latest/ucd/PropertyValueAliases.txt>.
3. Let *value* be the canonical property value of *v* as given in the “Canonical property value” column of the corresponding row.
4. Return the [List](#) of Unicode code points *value*.

Implementations must support the Unicode property values and property value aliases listed in <https://unicode.org/Public/UCD/latest/ucd/PropertyValueAliases.txt> for the properties listed in [Table 65](#). To ensure interoperability, implementations must not support any other property values or property value aliases.

NOTE 1 For example, `Xpeo` and `Old_Persian` are valid `Script_Extensions` values, but `xpeo` and `Old Persian` aren't.

NOTE 2 This algorithm differs from [the matching rules for symbolic values listed in UAX44](#): case, [white space](#), U+002D (HYPHEN-MINUS), and U+005F (LOW LINE) are not ignored, and the `Is` prefix is not supported.

## 22.2.3 Abstract Operations for RegExp Creation

### 22.2.3.1 RegExpCreate ( *P*, *F* )

The abstract operation `RegExpCreate` takes arguments *P* (an [ECMAScript language value](#)) and *F* (a `String` or `undefined`) and returns either a [normal completion containing](#) an `Object` or a [throw completion](#). It performs the following steps when called:

1. Let *obj* be ! `RegExpAlloc(%RegExp%)`.
2. Return ? `RegExpInitialize(obj, P, F)`.

### 22.2.3.2 RegExpAlloc ( *newTarget* )

The abstract operation `RegExpAlloc` takes argument *newTarget* (a [constructor](#)) and returns either a [normal completion containing](#) an `Object` or a [throw completion](#). It performs the following steps when called:

1. Let *obj* be ? `OrdinaryCreateFromConstructor(newTarget, "%RegExp.prototype%", « [[OriginalSource]], [[OriginalFlags]], [[RegExpRecord]], [[RegExpMatcher]] »)`.
2. Perform ! `DefinePropertyOrThrow(obj, "lastIndex", PropertyDescriptor { [[Writable]]: true, [[Enumerable]]: false, [[Configurable]]: false })`.
3. Return *obj*.

### 22.2.3.3 RegExpInitialize ( *obj*, *pattern*, *flags* )

The abstract operation `RegExpInitialize` takes arguments *obj* (an `Object`), *pattern* (an [ECMAScript language value](#)), and *flags* (an [ECMAScript language value](#)) and returns either a [normal completion containing](#) an `Object` or a [throw completion](#). It performs the following steps when called:

1. If *pattern* is `undefined`, let *P* be the empty `String`.
2. Else, let *P* be ? `ToString(pattern)`.
3. If *flags* is `undefined`, let *F* be the empty `String`.



4. Else, let *F* be ? ToString(*flags*).
5. If *F* contains any code unit other than "d", "g", "i", "m", "s", "u", or "y", or if *F* contains any code unit more than once, throw a **SyntaxError** exception.
6. If *F* contains "i", let *i* be **true**; else let *i* be **false**.
7. If *F* contains "m", let *m* be **true**; else let *m* be **false**.
8. If *F* contains "s", let *s* be **true**; else let *s* be **false**.
9. If *F* contains "u", let *u* be **true**; else let *u* be **false**.
10. If *u* is **true**, then
  - a. Let *patternText* be ToStringToCodePoints(*P*).
11. Else,
  - a. Let *patternText* be the result of interpreting each of *P*'s 16-bit elements as a Unicode BMP code point. UTF-16 decoding is not applied to the elements.
12. Let *parseResult* be ParsePattern(*patternText*, *u*).
13. If *parseResult* is a non-empty List of **SyntaxError** objects, throw a **SyntaxError** exception.
14. Assert: *parseResult* is a *Pattern Parse Node*.
15. Set *obj*.[[OriginalSource]] to *P*.
16. Set *obj*.[[OriginalFlags]] to *F*.
17. Let *capturingGroupsCount* be CountLeftCapturingParensWithin(*parseResult*).
18. Let *rer* be the **RegExp Record** { [[IgnoreCase]]: *i*, [[Multiline]]: *m*, [[DotAll]]: *s*, [[Unicode]]: *u*, [[CapturingGroupsCount]]: *capturingGroupsCount* }.
19. Set *obj*.[[RegExpRecord]] to *rer*.
20. Set *obj*.[[RegExpMatcher]] to CompilePattern of *parseResult* with argument *rer*.
21. Perform ? Set(*obj*, "lastIndex", +0<sub>F</sub>, **true**).
22. Return *obj*.

#### 22.2.3.4 Static Semantics: ParsePattern ( *patternText*, *u* )

The abstract operation ParsePattern takes arguments *patternText* (a sequence of Unicode code points) and *u* (a Boolean) and returns a *Parse Node* or a non-empty List of **SyntaxError** objects.

NOTE This section is amended in B.1.2.9.

It performs the following steps when called:

1. If *u* is **true**, then
  - a. Let *parseResult* be ParseText(*patternText*, Pattern<sub>[+UnicodeMode, +N]</sub> ).
2. Else,
  - a. Let *parseResult* be ParseText(*patternText*, Pattern<sub>[-UnicodeMode, +N]</sub> ).
3. Return *parseResult*.

#### 22.2.4 The RegExp Constructor

The RegExp **constructor**:

- is %RegExp%.
- is the initial value of the "RegExp" property of the *global object*.
- creates and initializes a new RegExp object when called as a function rather than as a **constructor**. Thus the function call **RegExp(...)** is equivalent to the object creation expression **new RegExp(...)** with the same arguments.
- may be used as the value of an **extends** clause of a class definition. Subclass **constructors** that intend to inherit the specified RegExp behaviour must include a **super** call to the RegExp **constructor** to create and initialize subclass instances with the necessary internal slots.

### 22.2.4.1 RegExp ( *pattern*, *flags* )

This function performs the following steps when called:

1. Let *patternIsRegExp* be ? `IsRegExp(pattern)`.
2. If *NewTarget* is **undefined**, then
  - a. Let *newTarget* be the **active function object**.
  - b. If *patternIsRegExp* is **true** and *flags* is **undefined**, then
    - i. Let *patternConstructor* be ? `Get(pattern, "constructor")`.
    - ii. If `SameValue(newTarget, patternConstructor)` is **true**, return *pattern*.
3. Else, let *newTarget* be *NewTarget*.
4. If *pattern* is an **Object** and *pattern* has a `[[RegExpMatcher]]` internal slot, then
  - a. Let *P* be *pattern*.`[[OriginalSource]]`.
  - b. If *flags* is **undefined**, let *F* be *pattern*.`[[OriginalFlags]]`.
  - c. Else, let *F* be *flags*.
5. Else if *patternIsRegExp* is **true**, then
  - a. Let *P* be ? `Get(pattern, "source")`.
  - b. If *flags* is **undefined**, then
    - i. Let *F* be ? `Get(pattern, "flags")`.
  - c. Else, let *F* be *flags*.
6. Else,
  - a. Let *P* be *pattern*.
  - b. Let *F* be *flags*.
7. Let *O* be ? `RegExpAlloc(newTarget)`.
8. Return ? `RegExpInitialize(O, P, F)`.

**NOTE** If *pattern* is supplied using a *StringLiteral*, the usual escape sequence substitutions are performed before the *String* is processed by this function. If *pattern* must contain an escape sequence to be recognized by this function, any U+005C (REVERSE SOLIDUS) code points must be escaped within the *StringLiteral* to prevent them being removed when the contents of the *StringLiteral* are formed.

### 22.2.5 Properties of the RegExp Constructor

The RegExp **constructor**:

- has a `[[Prototype]]` internal slot whose value is `%Function.prototype%`.
- has the following properties:

#### 22.2.5.1 RegExp.prototype

The initial value of `RegExp.prototype` is the **RegExp prototype object**.

This property has the attributes { `[[Writable]]`: **false**, `[[Enumerable]]`: **false**, `[[Configurable]]`: **false** }.

#### 22.2.5.2 get RegExp [ @@species ]

`RegExp[@@species]` is an **accessor property** whose set accessor function is **undefined**. Its get accessor function performs the following steps when called:

1. Return the **this** value.

The value of the "name" property of this function is "get [Symbol.species]".

NOTE     RegExp prototype methods normally use their **this** value's [constructor](#) to create a derived object. However, a subclass [constructor](#) may over-ride that default behaviour by redefining its [@@species](#) property.

## 22.2.6 Properties of the RegExp Prototype Object

The *RegExp* prototype object:

- is `%RegExp.prototype%`.
- is an [ordinary object](#).
- is not a RegExp instance and does not have a `[[RegExpMatcher]]` internal slot or any of the other internal slots of RegExp instance objects.
- has a `[[Prototype]]` internal slot whose value is `%Object.prototype%`.

NOTE     The RegExp prototype object does not have a "valueOf" property of its own; however, it inherits the "valueOf" property from the [Object prototype object](#).

### 22.2.6.1 RegExp.prototype.constructor

The initial value of `RegExp.prototype.constructor` is `%RegExp%`.

### 22.2.6.2 RegExp.prototype.exec ( *string* )

This method searches *string* for an occurrence of the regular expression pattern and returns an Array containing the results of the match, or `null` if *string* did not match.

It performs the following steps when called:

1. Let *R* be the **this** value.
2. Perform ? [RequireInternalSlot](#)(*R*, `[[RegExpMatcher]]`).
3. Let *S* be ? [ToString](#)(*string*).
4. Return ? [RegExpBuiltinExec](#)(*R*, *S*).

### 22.2.6.3 get RegExp.prototype.dotAll

`RegExp.prototype.dotAll` is an [accessor property](#) whose set accessor function is `undefined`. Its get accessor function performs the following steps when called:

1. Let *R* be the **this** value.
2. Let *cu* be the code unit 0x0073 (LATIN SMALL LETTER S).
3. Return ? [RegExpHasFlag](#)(*R*, *cu*).

### 22.2.6.4 get RegExp.prototype.flags

`RegExp.prototype.flags` is an [accessor property](#) whose set accessor function is `undefined`. Its get accessor function performs the following steps when called:

1. Let *R* be the **this** value.
2. If *R* is not an [Object](#), throw a `TypeError` exception.

3. Let *codeUnits* be a new empty *List*.
4. Let *hasIndices* be *ToBoolean*(? *Get*(*R*, "hasIndices")).
5. If *hasIndices* is **true**, append the code unit 0x0064 (LATIN SMALL LETTER D) to *codeUnits*.
6. Let *global* be *ToBoolean*(? *Get*(*R*, "global")).
7. If *global* is **true**, append the code unit 0x0067 (LATIN SMALL LETTER G) to *codeUnits*.
8. Let *ignoreCase* be *ToBoolean*(? *Get*(*R*, "ignoreCase")).
9. If *ignoreCase* is **true**, append the code unit 0x0069 (LATIN SMALL LETTER I) to *codeUnits*.
10. Let *multiline* be *ToBoolean*(? *Get*(*R*, "multiline")).
11. If *multiline* is **true**, append the code unit 0x006D (LATIN SMALL LETTER M) to *codeUnits*.
12. Let *dotAll* be *ToBoolean*(? *Get*(*R*, "dotAll")).
13. If *dotAll* is **true**, append the code unit 0x0073 (LATIN SMALL LETTER S) to *codeUnits*.
14. Let *unicode* be *ToBoolean*(? *Get*(*R*, "unicode")).
15. If *unicode* is **true**, append the code unit 0x0075 (LATIN SMALL LETTER U) to *codeUnits*.
16. Let *sticky* be *ToBoolean*(? *Get*(*R*, "sticky")).
17. If *sticky* is **true**, append the code unit 0x0079 (LATIN SMALL LETTER Y) to *codeUnits*.
18. Return the String value whose code units are the elements of the *List* *codeUnits*. If *codeUnits* has no elements, the empty String is returned.

#### 22.2.6.4.1 *RegExp*.hasFlag ( *R*, *codeUnit* )

The abstract operation *RegExp*.hasFlag takes arguments *R* (an *ECMAScript* language value) and *codeUnit* (a code unit) and returns either a *normal completion* containing either a Boolean or **undefined**, or a *throw completion*. It performs the following steps when called:

1. If *R* is not an *Object*, throw a **TypeError** exception.
2. If *R* does not have an *[[OriginalFlags]]* internal slot, then
  - a. If *SameValue*(*R*, %*RegExp*.prototype%) is **true**, return **undefined**.
  - b. Otherwise, throw a **TypeError** exception.
3. Let *flags* be *R*.*[[OriginalFlags]]*.
4. If *flags* contains *codeUnit*, return **true**.
5. Return **false**.

#### 22.2.6.5 get *RegExp*.prototype.global

*RegExp*.prototype.global is an *accessor property* whose set accessor function is **undefined**. Its get accessor function performs the following steps when called:

1. Let *R* be the **this** value.
2. Let *cu* be the code unit 0x0067 (LATIN SMALL LETTER G).
3. Return ? *RegExp*.hasFlag(*R*, *cu*).

#### 22.2.6.6 get *RegExp*.prototype.hasIndices

*RegExp*.prototype.hasIndices is an *accessor property* whose set accessor function is **undefined**. Its get accessor function performs the following steps when called:

1. Let *R* be the **this** value.
2. Let *cu* be the code unit 0x0064 (LATIN SMALL LETTER D).
3. Return ? *RegExp*.hasFlag(*R*, *cu*).

### 22.2.6.7 get RegExp.prototype.ignoreCase

`RegExp.prototype.ignoreCase` is an [accessor property](#) whose set accessor function is **undefined**. Its get accessor function performs the following steps when called:

1. Let *R* be the **this** value.
2. Let *cu* be the code unit 0x0069 (LATIN SMALL LETTER I).
3. Return ? [RegExpHasFlag](#)(*R*, *cu*).

### 22.2.6.8 RegExp.prototype [ @@match ] ( *string* )

This method performs the following steps when called:

1. Let *rx* be the **this** value.
2. If *rx* is not an [Object](#), throw a **TypeError** exception.
3. Let *S* be ? [ToString](#)(*string*).
4. Let *flags* be ? [ToString](#)(? [Get](#)(*rx*, "flags")).
5. If *flags* does not contain "g", then
  - a. Return ? [RegExpExec](#)(*rx*, *S*).
6. Else,
  - a. If *flags* contains "u", let *fullUnicode* be **true**. Otherwise, let *fullUnicode* be **false**.
  - b. Perform ? [Set](#)(*rx*, "lastIndex", +0<sub>F</sub>, **true**).
  - c. Let *A* be ! [ArrayCreate](#)(0).
  - d. Let *n* be 0.
  - e. Repeat,
    - i. Let *result* be ? [RegExpExec](#)(*rx*, *S*).
    - ii. If *result* is **null**, then
      1. If *n* = 0, return **null**.
      2. Return *A*.
    - iii. Else,
      1. Let *matchStr* be ? [ToString](#)(? [Get](#)(*result*, "0")).
      2. Perform ! [CreateDataPropertyOrThrow](#)(*A*, ! [ToString](#)( $\mathbb{F}(n)$ ), *matchStr*).
      3. If *matchStr* is the empty String, then
        - a. Let *thisIndex* be  $\mathbb{R}$ (? [ToLength](#)(? [Get](#)(*rx*, "lastIndex"))).
        - b. Let *nextIndex* be [AdvanceStringIndex](#)(*S*, *thisIndex*, *fullUnicode*).
        - c. Perform ? [Set](#)(*rx*, "lastIndex",  $\mathbb{F}(\text{nextIndex})$ , **true**).
  4. Set *n* to *n* + 1.

The value of the "name" property of this method is "[Symbol.match]".

**NOTE** The `@@match` property is used by the `IsRegExp` abstract operation to identify objects that have the basic behaviour of regular expressions. The absence of a `@@match` property or the existence of such a property whose value does not Boolean coerce to **true** indicates that the object is not intended to be used as a regular expression object.

### 22.2.6.9 RegExp.prototype [ @@matchAll ] ( *string* )

This method performs the following steps when called:

1. Let *R* be the **this** value.
2. If *R* is not an [Object](#), throw a **TypeError** exception.

3. Let *S* be ? ToString(*string*).
4. Let *C* be ? SpeciesConstructor(*R*, %RegExp%).
5. Let *flags* be ? ToString(? Get(*R*, "flags")).
6. Let *matcher* be ? Construct(*C*, « *R*, *flags* »).
7. Let *lastIndex* be ? ToLength(? Get(*R*, "lastIndex")).
8. Perform ? Set(*matcher*, "lastIndex", *lastIndex*, true).
9. If *flags* contains "g", let *global* be true.
10. Else, let *global* be false.
11. If *flags* contains "u", let *fullUnicode* be true.
12. Else, let *fullUnicode* be false.
13. Return CreateRegExpStringIterator(*matcher*, *S*, *global*, *fullUnicode*).

The value of the "name" property of this method is "[Symbol.matchAll]".

### 22.2.6.10 get RegExp.prototype.multiline

**RegExp.prototype.multiline** is an [accessor property](#) whose set accessor function is **undefined**. Its get accessor function performs the following steps when called:

1. Let *R* be the **this** value.
2. Let *cu* be the code unit 0x006D (LATIN SMALL LETTER M).
3. Return ? RegExpHasFlag(*R*, *cu*).

### 22.2.6.11 RegExp.prototype [ @@replace ] ( *string*, *replaceValue* )

This method performs the following steps when called:

1. Let *rx* be the **this** value.
2. If *rx* is not an Object, throw a **TypeError** exception.
3. Let *S* be ? ToString(*string*).
4. Let *lengthS* be the length of *S*.
5. Let *functionalReplace* be [IsCallable](#)(*replaceValue*).
6. If *functionalReplace* is **false**, then
  - a. Set *replaceValue* to ? ToString(*replaceValue*).
7. Let *flags* be ? ToString(? Get(*rx*, "flags")).
8. If *flags* contains "g", let *global* be **true**. Otherwise, let *global* be **false**.
9. If *global* is **true**, then
  - a. If *flags* contains "u", let *fullUnicode* be **true**. Otherwise, let *fullUnicode* be **false**.
  - b. Perform ? Set(*rx*, "lastIndex", +0<sub>F</sub>, true).
10. Let *results* be a new empty List.
11. Let *done* be **false**.
12. Repeat, while *done* is **false**,
  - a. Let *result* be ? [RegExpExec](#)(*rx*, *S*).
  - b. If *result* is **null**, set *done* to **true**.
  - c. Else,
    - i. Append *result* to *results*.
    - ii. If *global* is **false**, set *done* to **true**.
    - iii. Else,
      1. Let *matchStr* be ? ToString(? Get(*result*, "0")).
      2. If *matchStr* is the empty String, then
        - a. Let *thisIndex* be  $\mathbb{R}$ (? ToLength(? Get(*rx*, "lastIndex"))).
        - b. Let *nextIndex* be [AdvanceStringIndex](#)(*S*, *thisIndex*, *fullUnicode*).

- c. Perform ? Set(*rx*, "lastIndex",  $\mathbb{F}(\text{nextIndex})$ , true).
13. Let *accumulatedResult* be the empty String.
14. Let *nextSourcePosition* be 0.
15. For each element *result* of *results*, do
  - a. Let *resultLength* be ? LengthOfArrayLike(*result*).
  - b. Let *nCaptures* be  $\max(\text{resultLength} - 1, 0)$ .
  - c. Let *matched* be ? ToString(? Get(*result*, "0")).
  - d. Let *matchLength* be the length of *matched*.
  - e. Let *position* be ? ToIntegerOrInfinity(? Get(*result*, "index")).
  - f. Set *position* to the result of clamping *position* between 0 and *lengthS*.
  - g. Let *captures* be a new empty List.
  - h. Let *n* be 1.
  - i. Repeat, while  $n \leq n\text{Captures}$ ,
    - i. Let *capN* be ? Get(*result*, ! ToString( $\mathbb{F}(n)$ )).
    - ii. If *capN* is not **undefined**, then
      1. Set *capN* to ? ToString(*capN*).
    - iii. Append *capN* to *captures*.
    - iv. NOTE: When  $n = 1$ , the preceding step puts the first element into *captures* (at index 0).  
More generally, the  $n^{\text{th}}$  capture (the characters captured by the  $n^{\text{th}}$  set of capturing parentheses) is at *captures*[ $n - 1$ ].
    - v. Set *n* to  $n + 1$ .
  - j. Let *namedCaptures* be ? Get(*result*, "groups").
  - k. If *functionalReplace* is **true**, then
    - i. Let *replacerArgs* be the list-concatenation of « *matched* », *captures*, and «  $\mathbb{F}(\text{position})$ , *S* ».
    - ii. If *namedCaptures* is not **undefined**, then
      1. Append *namedCaptures* to *replacerArgs*.
    - iii. Let *replValue* be ? Call(*replaceValue*, **undefined**, *replacerArgs*).
    - iv. Let *replacement* be ? ToString(*replValue*).
  - l. Else,
    - i. If *namedCaptures* is not **undefined**, then
      1. Set *namedCaptures* to ? ToObject(*namedCaptures*).
    - ii. Let *replacement* be ? GetSubstitution(*matched*, *S*, *position*, *captures*, *namedCaptures*, *replaceValue*).
  - m. If  $\text{position} \geq \text{nextSourcePosition}$ , then
    - i. NOTE: *position* should not normally move backwards. If it does, it is an indication of an ill-behaving RegExp subclass or use of an access triggered side-effect to change the global flag or other characteristics of *rx*. In such cases, the corresponding substitution is ignored.
    - ii. Set *accumulatedResult* to the string-concatenation of *accumulatedResult*, the substring of *S* from *nextSourcePosition* to *position*, and *replacement*.
    - iii. Set *nextSourcePosition* to  $\text{position} + \text{matchLength}$ .
16. If  $\text{nextSourcePosition} \geq \text{lengthS}$ , return *accumulatedResult*.
17. Return the string-concatenation of *accumulatedResult* and the substring of *S* from *nextSourcePosition*.

The value of the "name" property of this method is "[Symbol.replace]".

## 22.2.6.12 RegExp.prototype [ @@search ] ( *string* )

This method performs the following steps when called:

1. Let *rx* be the **this** value.
2. If *rx* is not an Object, throw a **TypeError** exception.
3. Let *S* be ? ToString(*string*).
4. Let *previousLastIndex* be ? Get(*rx*, "lastIndex").
5. If SameValue(*previousLastIndex*, +0<sub>F</sub>) is false, then
  - a. Perform ? Set(*rx*, "lastIndex", +0<sub>F</sub>, true).
6. Let *result* be ? RegExpExec(*rx*, *S*).
7. Let *currentLastIndex* be ? Get(*rx*, "lastIndex").
8. If SameValue(*currentLastIndex*, *previousLastIndex*) is false, then
  - a. Perform ? Set(*rx*, "lastIndex", *previousLastIndex*, true).
9. If *result* is null, return -1<sub>F</sub>.
10. Return ? Get(*result*, "index").

The value of the "name" property of this method is "[Symbol.search]".

**NOTE** The "lastIndex" and "global" properties of this RegExp object are ignored when performing the search. The "lastIndex" property is left unchanged.

### 22.2.6.13 get RegExp.prototype.source

**RegExp.prototype.source** is an [accessor property](#) whose set accessor function is **undefined**. Its get accessor function performs the following steps when called:

1. Let *R* be the **this** value.
2. If *R* is not an Object, throw a **TypeError** exception.
3. If *R* does not have an [[OriginalSource]] internal slot, then
  - a. If SameValue(*R*, %RegExp.prototype%) is true, return "(?:)".
  - b. Otherwise, throw a **TypeError** exception.
4. **Assert:** *R* has an [[OriginalFlags]] internal slot.
5. Let *src* be *R*.[[OriginalSource]].
6. Let *flags* be *R*.[[OriginalFlags]].
7. Return [EscapeRegExpPattern](#)(*src*, *flags*).

#### 22.2.6.13.1 EscapeRegExpPattern ( *P*, *F* )

The abstract operation [EscapeRegExpPattern](#) takes arguments *P* (a String) and *F* (a String) and returns a String. It performs the following steps when called:

1. Let *S* be a String in the form of a *Pattern*<sub>[~UnicodeMode]</sub> (*Pattern*<sub>[+UnicodeMode]</sub> if *F* contains "u") equivalent to *P* interpreted as UTF-16 encoded Unicode code points (6.1.4), in which certain code points are escaped as described below. *S* may or may not differ from *P*; however, the [Abstract Closure](#) that would result from evaluating *S* as a *Pattern*<sub>[~UnicodeMode]</sub> (*Pattern*<sub>[+UnicodeMode]</sub> if *F* contains "u") must behave identically to the [Abstract Closure](#) given by the constructed object's [[RegExpMatcher]] internal slot. Multiple calls to this abstract operation using the same values for *P* and *F* must produce identical results.
2. The code points / or any *LineTerminator* occurring in the pattern shall be escaped in *S* as necessary to ensure that the [string-concatenation](#) of *"I"*, *S*, *"I"*, and *F* can be parsed (in an appropriate lexical context) as a *RegularExpressionLiteral* that behaves identically to the constructed regular expression. For example, if *P* is *"I"*, then *S* could be *"V"* or *"\u002F"*, among other possibilities, but not *"I"*,



because `///` followed by `F` would be parsed as a `SingleLineComment` rather than a `RegularExpressionLiteral`. If `P` is the empty String, this specification can be met by letting `S` be `"(?:)"`.

3. Return `S`.

## 22.2.6.14 `RegExp.prototype [ @@split ] ( string, limit )`

**NOTE 1** This method returns an Array into which substrings of the result of converting *string* to a String have been stored. The substrings are determined by searching from left to right for matches of the **this** value regular expression; these occurrences are not part of any String in the returned array, but serve to divide up the String value.

The **this** value may be an empty regular expression or a regular expression that can match an empty String. In this case, the regular expression does not match the empty substring at the beginning or end of the input String, nor does it match the empty substring at the end of the previous separator match. (For example, if the regular expression matches the empty String, the String is split up into individual code unit elements; the length of the result array equals the length of the String, and each substring contains one code unit.) Only the first match at a given index of the String is considered, even if backtracking could yield a non-empty substring match at that index. (For example, `/a*?/[Symbol.split]("ab")` evaluates to the array `["a", "b"]`, while `/a*/[Symbol.split]("ab")` evaluates to the array `["", "b"]`.)

If *string* is (or converts to) the empty String, the result depends on whether the regular expression can match the empty String. If it can, the result array contains no elements. Otherwise, the result array contains one element, which is the empty String.

If the regular expression contains capturing parentheses, then each time *separator* is matched the results (including any **undefined** results) of the capturing parentheses are spliced into the output array. For example,

```
/<(\w)?([^\<>]+)>/[Symbol.split]("A<B>bold</B>and<CODE>coded</CODE>")
```

evaluates to the array

```
["A", undefined, "B", "bold", "/", "B", "and", undefined, "CODE", "coded", "/", "CODE", ""]
```

If *limit* is not **undefined**, then the output array is truncated so that it contains no more than *limit* elements.

This method performs the following steps when called:

1. Let *rx* be the **this** value.
2. If *rx* is not an Object, throw a **TypeError** exception.
3. Let *S* be ? `Tostring(string)`.
4. Let *C* be ? `SpeciesConstructor(rx, %RegExp%)`.
5. Let *flags* be ? `Tostring(? Get(rx, "flags"))`.
6. If *flags* contains "u", let *unicodeMatching* be **true**.
7. Else, let *unicodeMatching* be **false**.
8. If *flags* contains "y", let *newFlags* be *flags*.
9. Else, let *newFlags* be the string-concatenation of *flags* and "y".
10. Let *splitter* be ? `Construct(C, « rx, newFlags »)`.
11. Let *A* be ! `ArrayCreate(0)`.
12. Let *lengthA* be 0.
13. If *limit* is **undefined**, let *lim* be  $2^{32} - 1$ ; else let *lim* be `ℝ(? ToUint32(limit))`.
14. If *lim* = 0, return *A*.

15. If *S* is the empty String, then
  - a. Let *z* be ? `RegExpExec(splitter, S)`.
  - b. If *z* is not **null**, return *A*.
  - c. Perform ! `CreateDataPropertyOrThrow(A, "0", S)`.
  - d. Return *A*.
16. Let *size* be the length of *S*.
17. Let *p* be 0.
18. Let *q* be *p*.
19. Repeat, while *q* < *size*,
  - a. Perform ? `Set(splitter, "lastIndex", F(q), true)`.
  - b. Let *z* be ? `RegExpExec(splitter, S)`.
  - c. If *z* is **null**, set *q* to `AdvanceStringIndex(S, q, unicodeMatching)`.
  - d. Else,
    - i. Let *e* be `R(? ToLength(? Get(splitter, "lastIndex")))`.
    - ii. Set *e* to `min(e, size)`.
    - iii. If *e* = *p*, set *q* to `AdvanceStringIndex(S, q, unicodeMatching)`.
    - iv. Else,
      1. Let *T* be the substring of *S* from *p* to *q*.
      2. Perform ! `CreateDataPropertyOrThrow(A, ! ToString(F(lengthA)), T)`.
      3. Set *lengthA* to *lengthA* + 1.
      4. If *lengthA* = *lim*, return *A*.
      5. Set *p* to *e*.
      6. Let *numberOfCaptures* be ? `LengthOfArrayLike(z)`.
      7. Set *numberOfCaptures* to `max(numberOfCaptures - 1, 0)`.
      8. Let *i* be 1.
      9. Repeat, while *i* ≤ *numberOfCaptures*,
        - a. Let *nextCapture* be ? `Get(z, ! ToString(F(i)))`.
        - b. Perform ! `CreateDataPropertyOrThrow(A, ! ToString(F(lengthA)), nextCapture)`.
        - c. Set *i* to *i* + 1.
        - d. Set *lengthA* to *lengthA* + 1.
        - e. If *lengthA* = *lim*, return *A*.
20. Let *T* be the substring of *S* from *p* to *size*.
21. Perform ! `CreateDataPropertyOrThrow(A, ! ToString(F(lengthA)), T)`.
22. Return *A*.

The value of the "name" property of this method is "[Symbol.split]".

NOTE 2 This method ignores the value of the "global" and "sticky" properties of this RegExp object.

### 22.2.6.15 get `RegExp.prototype.sticky`

`RegExp.prototype.sticky` is an [accessor property](#) whose set accessor function is **undefined**. Its get accessor function performs the following steps when called:

1. Let *R* be the **this** value.
2. Let *cu* be the code unit 0x0079 (LATIN SMALL LETTER Y).
3. Return ? `RegExpHasFlag(R, cu)`.

### 22.2.6.16 RegExp.prototype.test ( S )

This method performs the following steps when called:

1. Let *R* be the **this** value.
2. If *R* is not an Object, throw a **TypeError** exception.
3. Let *string* be ? ToString(*S*).
4. Let *match* be ? RegExpExec(*R*, *string*).
5. If *match* is not **null**, return **true**; else return **false**.

### 22.2.6.17 RegExp.prototype.toString ( )

1. Let *R* be the **this** value.
2. If *R* is not an Object, throw a **TypeError** exception.
3. Let *pattern* be ? ToString(? Get(*R*, "source")).
4. Let *flags* be ? ToString(? Get(*R*, "flags")).
5. Let *result* be the string-concatenation of "/", *pattern*, "/", and *flags*.
6. Return *result*.

**NOTE** The returned String has the form of a *RegularExpressionLiteral* that evaluates to another RegExp object with the same behaviour as this object.

### 22.2.6.18 get RegExp.prototype.unicode

**RegExp.prototype.unicode** is an [accessor property](#) whose set accessor function is **undefined**. Its get accessor function performs the following steps when called:

1. Let *R* be the **this** value.
2. Let *cu* be the code unit 0x0075 (LATIN SMALL LETTER U).
3. Return ? RegExpHasFlag(*R*, *cu*).

## 22.2.7 Abstract Operations for RegExp Matching

### 22.2.7.1 RegExpExec ( R, S )

The abstract operation RegExpExec takes arguments *R* (an Object) and *S* (a String) and returns either a [normal completion containing](#) either an Object or **null**, or a [throw completion](#). It performs the following steps when called:

1. Let *exec* be ? Get(*R*, "exec").
2. If [IsCallable](#)(*exec*) is **true**, then
  - a. Let *result* be ? Call(*exec*, *R*, « *S* »).
  - b. If *result* is not an Object and *result* is not **null**, throw a **TypeError** exception.
  - c. Return *result*.
3. Perform ? [RequireInternalSlot](#)(*R*, [[RegExpMatcher]]).
4. Return ? [RegExpBuiltinExec](#)(*R*, *S*).

**NOTE** If a callable **"exec"** property is not found this algorithm falls back to attempting to use the built-in RegExp matching algorithm. This provides compatible behaviour for code written for prior editions where most built-in algorithms that use regular expressions did not perform a dynamic property lookup of **"exec"**.

### 22.2.7.2 RegExpBuiltinExec ( *R*, *S* )

The abstract operation RegExpBuiltinExec takes arguments *R* (an initialized RegExp instance) and *S* (a String) and returns either a **normal completion containing** either an **Array exotic object** or **null**, or a **throw completion**. It performs the following steps when called:

1. Let *length* be the length of *S*.
2. Let *lastIndex* be  $\mathbb{R}(? \text{ToLength}(? \text{Get}(R, \text{"lastIndex"})))$ .
3. Let *flags* be *R*.[[OriginalFlags]].
4. If *flags* contains **"g"**, let *global* be **true**; else let *global* be **false**.
5. If *flags* contains **"y"**, let *sticky* be **true**; else let *sticky* be **false**.
6. If *flags* contains **"d"**, let *hasIndices* be **true**; else let *hasIndices* be **false**.
7. If *global* is **false** and *sticky* is **false**, set *lastIndex* to 0.
8. Let *matcher* be *R*.[[RegExpMatcher]].
9. If *flags* contains **"u"**, let *fullUnicode* be **true**; else let *fullUnicode* be **false**.
10. Let *matchSucceeded* be **false**.
11. If *fullUnicode* is **true**, let *input* be **StringToCodePoints**(*S*). Otherwise, let *input* be a **List** whose elements are the code units that are the elements of *S*.
12. NOTE: Each element of *input* is considered to be a character.
13. Repeat, while *matchSucceeded* is **false**,
  - a. If *lastIndex* > *length*, then
    - i. If *global* is **true** or *sticky* is **true**, then
      1. Perform ? **Set**(*R*, **"lastIndex"**,  $\mathbb{F}(+0)$ , **true**).
    - ii. Return **null**.
  - b. Let *inputIndex* be the index into *input* of the character that was obtained from element *lastIndex* of *S*.
  - c. Let *r* be *matcher*(*input*, *inputIndex*).
  - d. If *r* is failure, then
    - i. If *sticky* is **true**, then
      1. Perform ? **Set**(*R*, **"lastIndex"**,  $\mathbb{F}(+0)$ , **true**).
      2. Return **null**.
    - ii. Set *lastIndex* to **AdvanceStringIndex**(*S*, *lastIndex*, *fullUnicode*).
  - e. Else,
    - i. **Assert**: *r* is a **MatchState**.
    - ii. Set *matchSucceeded* to **true**.
14. Let *e* be *r*'s **endIndex** value.
15. If *fullUnicode* is **true**, set *e* to **GetStringIndex**(*S*, *e*).
16. If *global* is **true** or *sticky* is **true**, then
  - a. Perform ? **Set**(*R*, **"lastIndex"**,  $\mathbb{F}(e)$ , **true**).
17. Let *n* be the number of elements in *r*'s **captures List**.
18. **Assert**:  $n = R.[[RegExpRecord]].[[CapturingGroupsCount]]$ .
19. **Assert**:  $n < 2^{32} - 1$ .
20. Let *A* be ! **ArrayCreate**(*n* + 1).
21. **Assert**: The **mathematical value** of *A*'s **"length"** property is *n* + 1.
22. Perform ! **CreateDataPropertyOrThrow**(*A*, **"index"**,  $\mathbb{F}(lastIndex)$ ).

23. Perform ! `CreateDataPropertyOrThrow(A, "input", S)`.
24. Let *match* be the `Match Record` { `[[StartIndex]]: lastIndex`, `[[EndIndex]]: e` }.
25. Let *indices* be a new empty `List`.
26. Let *groupNames* be a new empty `List`.
27. Append *match* to *indices*.
28. Let *matchedSubstr* be `GetMatchString(S, match)`.
29. Perform ! `CreateDataPropertyOrThrow(A, "0", matchedSubstr)`.
30. If *R* contains any `GroupName`, then
  - a. Let *groups* be `OrdinaryObjectCreate(null)`.
  - b. Let *hasGroups* be `true`.
31. Else,
  - a. Let *groups* be `undefined`.
  - b. Let *hasGroups* be `false`.
32. Perform ! `CreateDataPropertyOrThrow(A, "groups", groups)`.
33. For each `integer i` such that  $1 \leq i \leq n$ , in ascending order, do
  - a. Let *captureI* be *i*<sup>th</sup> element of *r*'s `captures List`.
  - b. If *captureI* is `undefined`, then
    - i. Let *capturedValue* be `undefined`.
    - ii. Append `undefined` to *indices*.
  - c. Else,
    - i. Let *captureStart* be *captureI*'s `startIndex`.
    - ii. Let *captureEnd* be *captureI*'s `endIndex`.
    - iii. If *fullUnicode* is `true`, then
      1. Set *captureStart* to `GetStringIndex(S, captureStart)`.
      2. Set *captureEnd* to `GetStringIndex(S, captureEnd)`.
    - iv. Let *capture* be the `Match Record` { `[[StartIndex]]: captureStart`, `[[EndIndex]]: captureEnd` }.
    - v. Let *capturedValue* be `GetMatchString(S, capture)`.
    - vi. Append *capture* to *indices*.
  - d. Perform ! `CreateDataPropertyOrThrow(A, ! ToString(F(i)), capturedValue)`.
  - e. If the *i*<sup>th</sup> capture of *R* was defined with a `GroupName`, then
    - i. Let *s* be the `CapturingGroupName` of that `GroupName`.
    - ii. Perform ! `CreateDataPropertyOrThrow(groups, s, capturedValue)`.
    - iii. Append *s* to *groupNames*.
  - f. Else,
    - i. Append `undefined` to *groupNames*.
34. If *hasIndices* is `true`, then
  - a. Let *indicesArray* be `MakeMatchIndicesIndexPairArray(S, indices, groupNames, hasGroups)`.
  - b. Perform ! `CreateDataPropertyOrThrow(A, "indices", indicesArray)`.
35. Return *A*.

### 22.2.7.3 AdvanceStringIndex ( *S*, *index*, *unicode* )

The abstract operation `AdvanceStringIndex` takes arguments *S* (a `String`), *index* (a non-negative `integer`), and *unicode* (a `Boolean`) and returns an `integer`. It performs the following steps when called:

1. **Assert:**  $index \leq 2^{53} - 1$ .
2. If *unicode* is `false`, return *index* + 1.
3. Let *length* be the length of *S*.
4. If  $index + 1 \geq length$ , return *index* + 1.
5. Let *cp* be `CodePointAt(S, index)`.

6. Return  $index + cp.[[CodeUnitCount]]$ .

#### 22.2.7.4 GetStringIndex ( *S*, *codePointIndex* )

The abstract operation GetStringIndex takes arguments *S* (a String) and *codePointIndex* (a non-negative integer) and returns a non-negative integer. It interprets *S* as a sequence of UTF-16 encoded code points, as described in 6.1.4, and returns the code unit index corresponding to code point index *codePointIndex* when such an index exists. Otherwise, it returns the length of *S*. It performs the following steps when called:

1. If *S* is the empty String, return 0.
2. Let *len* be the length of *S*.
3. Let *codeUnitCount* be 0.
4. Let *codePointCount* be 0.
5. Repeat, while  $codeUnitCount < len$ ,
  - a. If  $codePointCount = codePointIndex$ , return *codeUnitCount*.
  - b. Let *cp* be `CodePointAt(S, codeUnitCount)`.
  - c. Set *codeUnitCount* to  $codeUnitCount + cp.[[CodeUnitCount]]$ .
  - d. Set *codePointCount* to  $codePointCount + 1$ .
6. Return *len*.

#### 22.2.7.5 Match Records

A Match Record is a Record value used to encapsulate the start and end indices of a regular expression match or capture.

Match Records have the fields listed in Table 67.

Table 67: Match Record Fields

Field Name	Value	Meaning
<code>[[StartIndex]]</code>	a non-negative integer	The number of code units from the start of a string at which the match begins (inclusive).
<code>[[EndIndex]]</code>	an integer $\geq$ <code>[[StartIndex]]</code>	The number of code units from the start of a string at which the match ends (exclusive).

#### 22.2.7.6 GetMatchString ( *S*, *match* )

The abstract operation GetMatchString takes arguments *S* (a String) and *match* (a Match Record) and returns a String. It performs the following steps when called:

1. Assert:  $match.[[StartIndex]] \leq match.[[EndIndex]] \leq$  the length of *S*.
2. Return the substring of *S* from  $match.[[StartIndex]]$  to  $match.[[EndIndex]]$ .

#### 22.2.7.7 GetMatchIndexPair ( *S*, *match* )

The abstract operation GetMatchIndexPair takes arguments *S* (a String) and *match* (a Match Record) and returns an Array. It performs the following steps when called:

1. Assert:  $match.[[StartIndex]] \leq match.[[EndIndex]] \leq$  the length of *S*.
2. Return `CreateArrayFromList(«  $\mathbb{F}(match.[[StartIndex]])$ ,  $\mathbb{F}(match.[[EndIndex]])$  »)`.

### 22.2.7.8 MakeMatchIndicesIndexPairArray ( *S*, *indices*, *groupNames*, *hasGroups* )

The abstract operation MakeMatchIndicesIndexPairArray takes arguments *S* (a String), *indices* (a List of either Match Records or **undefined**), *groupNames* (a List of either Strings or **undefined**), and *hasGroups* (a Boolean) and returns an Array. It performs the following steps when called:

1. Let *n* be the number of elements in *indices*.
2. Assert:  $n < 2^{32} - 1$ .
3. Assert: *groupNames* has *n* - 1 elements.
4. NOTE: The *groupNames* List contains elements aligned with the *indices* List starting at *indices*[1].
5. Let *A* be ! ArrayCreate(*n*).
6. If *hasGroups* is **true**, then
  - a. Let *groups* be OrdinaryObjectCreate(**null**).
7. Else,
  - a. Let *groups* be **undefined**.
8. Perform ! CreateDataPropertyOrThrow(*A*, "groups", *groups*).
9. For each integer *i* such that  $0 \leq i < n$ , in ascending order, do
  - a. Let *matchIndices* be *indices*[*i*].
  - b. If *matchIndices* is not **undefined**, then
    - i. Let *matchIndexPair* be GetMatchIndexPair(*S*, *matchIndices*).
  - c. Else,
    - i. Let *matchIndexPair* be **undefined**.
  - d. Perform ! CreateDataPropertyOrThrow(*A*, ! ToString(*F*(*i*)), *matchIndexPair*).
  - e. If *i* > 0 and *groupNames*[*i* - 1] is not **undefined**, then
    - i. Assert: *groups* is not **undefined**.
    - ii. Perform ! CreateDataPropertyOrThrow(*groups*, *groupNames*[*i* - 1], *matchIndexPair*).
10. Return *A*.

## 22.2.8 Properties of RegExp Instances

RegExp instances are **ordinary objects** that inherit properties from the **RegExp prototype object**. RegExp instances have internal slots `[[OriginalSource]]`, `[[OriginalFlags]]`, `[[RegExpRecord]]`, and `[[RegExpMatcher]]`. The value of the `[[RegExpMatcher]]` internal slot is an **Abstract Closure** representation of the *Pattern* of the RegExp object.

**NOTE** Prior to ECMAScript 2015, RegExp instances were specified as having the own **data properties** "source", "global", "ignoreCase", and "multiline". Those properties are now specified as **accessor properties** of `RegExp.prototype`.

RegExp instances also have the following property:

### 22.2.8.1 lastIndex

The value of the "lastIndex" property specifies the String index at which to start the next match. It is coerced to an **integral Number** when used (see 22.2.7.2). This property shall have the attributes { `[[Writable]]`: **true**, `[[Enumerable]]`: **false**, `[[Configurable]]`: **false** }.

## 22.2.9 RegExp String Iterator Objects

A RegExp String Iterator is an object, that represents a specific iteration over some specific String instance object, matching against some specific RegExp instance object. There is not a named **constructor** for

RegExp String Iterator objects. Instead, RegExp String Iterator objects are created by calling certain methods of RegExp instance objects.

### 22.2.9.1 CreateRegExpStringIterator ( *R*, *S*, *global*, *fullUnicode* )

The abstract operation CreateRegExpStringIterator takes arguments *R* (an Object), *S* (a String), *global* (a Boolean), and *fullUnicode* (a Boolean) and returns a Generator. It performs the following steps when called:

1. Let *closure* be a new **Abstract Closure** with no parameters that captures *R*, *S*, *global*, and *fullUnicode* and performs the following steps when called:
  - a. Repeat,
    - i. Let *match* be ? **RegExpExec**(*R*, *S*).
    - ii. If *match* is **null**, return **undefined**.
    - iii. If *global* is **false**, then
      1. Perform ? **GeneratorYield**(**CreateIterResultObject**(*match*, **false**)).
      2. Return **undefined**.
    - iv. Let *matchStr* be ? **To**String(? **Get**(*match*, "0")).
    - v. If *matchStr* is the empty String, then
      1. Let *thisIndex* be  $\mathbb{R}$ (? **To**Length(? **Get**(*R*, "lastIndex"))).
      2. Let *nextIndex* be **AdvanceStringIndex**(*S*, *thisIndex*, *fullUnicode*).
      3. Perform ? **Set**(*R*, "lastIndex",  $\mathbb{F}$ (*nextIndex*), **true**).
    - vi. Perform ? **GeneratorYield**(**CreateIterResultObject**(*match*, **false**)).
2. Return **CreateIteratorFromClosure**(*closure*, "%RegExpStringIteratorPrototype%", %RegExpStringIteratorPrototype%).

### 22.2.9.2 The %RegExpStringIteratorPrototype% Object

The %*RegExpStringIteratorPrototype*% object:

- has properties that are inherited by all RegExp String Iterator Objects.
- is an **ordinary object**.
- has a [[Prototype]] internal slot whose value is %*IteratorPrototype*%.
- has the following properties:

#### 22.2.9.2.1 %RegExpStringIteratorPrototype%.next ( )

1. Return ? **GeneratorResume**(**this** value, empty, "%RegExpStringIteratorPrototype%").

#### 22.2.9.2.2 %RegExpStringIteratorPrototype% [ @@toStringTag ]

The initial value of the @@*toStringTag* property is the String value "RegExp String Iterator".

This property has the attributes { [[Writable]]: **false**, [[Enumerable]]: **false**, [[Configurable]]: **true** }.

## 23 Indexed Collections

### 23.1 Array Objects

Arrays are **exotic objects** that give special treatment to a certain class of property names. See 10.4.2 for a definition of this special treatment.



## 23.1.1 The Array Constructor

The Array [constructor](#):

- is `%Array%`.
- is the initial value of the **"Array"** property of the [global object](#).
- creates and initializes a new Array when called as a [constructor](#).
- also creates and initializes a new Array when called as a function rather than as a [constructor](#). Thus the function call **Array(...)** is equivalent to the object creation expression **new Array(...)** with the same arguments.
- is a function whose behaviour differs based upon the number and types of its arguments.
- may be used as the value of an **extends** clause of a class definition. Subclass [constructors](#) that intend to inherit the exotic Array behaviour must include a **super** call to the Array [constructor](#) to initialize subclass instances that are [Array exotic objects](#). However, most of the **Array.prototype** methods are generic methods that are not dependent upon their **this** value being an [Array exotic object](#).
- has a **"length"** property whose value is  $1_{\text{F}}$ .

### 23.1.1.1 Array ( ...*values* )

This function performs the following steps when called:

1. If `NewTarget` is **undefined**, let *newTarget* be the [active function object](#); else let *newTarget* be `NewTarget`.
2. Let *proto* be `? GetPrototypeFromConstructor(newTarget, "%Array.prototype%")`.
3. Let *numberOfArgs* be the number of elements in *values*.
4. If *numberOfArgs* = 0, then
  - a. Return `! ArrayCreate(0, proto)`.
5. Else if *numberOfArgs* = 1, then
  - a. Let *len* be *values*[0].
  - b. Let *array* be `! ArrayCreate(0, proto)`.
  - c. If *len* is not a Number, then
    - i. Perform `! CreateDataPropertyOrThrow(array, "0", len)`.
    - ii. Let *intLen* be  $1_{\text{F}}$ .
  - d. Else,
    - i. Let *intLen* be `! ToUint32(len)`.
    - ii. If `SameValueZero(intLen, len)` is **false**, throw a **RangeError** exception.
  - e. Perform `! Set(array, "length", intLen, true)`.
  - f. Return *array*.
6. Else,
  - a. **Assert**: *numberOfArgs*  $\geq 2$ .
  - b. Let *array* be `? ArrayCreate(numberOfArgs, proto)`.
  - c. Let *k* be 0.
  - d. Repeat, while *k* < *numberOfArgs*,
    - i. Let *Pk* be `! ToString(F(k))`.
    - ii. Let *itemK* be *values*[ *k* ].
    - iii. Perform `! CreateDataPropertyOrThrow(array, Pk, itemK)`.
    - iv. Set *k* to *k* + 1.
  - e. **Assert**: The mathematical value of *array*'s **"length"** property is *numberOfArgs*.
  - f. Return *array*.

## 23.1.2 Properties of the Array Constructor

The Array `constructor`:

- has a `[[Prototype]]` internal slot whose value is `%Function.prototype%`.
- has the following properties:

### 23.1.2.1 `Array.from ( items [ , mapfn [ , thisArg ] ] )`

This method performs the following steps when called:

1. Let `C` be the **this** value.
2. If `mapfn` is **undefined**, let `mapping` be **false**.
3. Else,
  - a. If `IsCallable(mapfn)` is **false**, throw a **TypeError** exception.
  - b. Let `mapping` be **true**.
4. Let `usingIterator` be `? GetMethod(items, @@iterator)`.
5. If `usingIterator` is not **undefined**, then
  - a. If `IsConstructor(C)` is **true**, then
    - i. Let `A` be `? Construct(C)`.
  - b. Else,
    - i. Let `A` be `! ArrayCreate(0)`.
  - c. Let `iteratorRecord` be `? GetIteratorFromMethod(items, usingIterator)`.
  - d. Let `k` be 0.
  - e. Repeat,
    - i. If  $k \geq 2^{53} - 1$ , then
      1. Let `error` be `ThrowCompletion`(a newly created **TypeError** object).
      2. Return `? IteratorClose(iteratorRecord, error)`.
    - ii. Let `Pk` be `! ToString(ℱ(k))`.
    - iii. Let `next` be `? IteratorStep(iteratorRecord)`.
    - iv. If `next` is **false**, then
      1. Perform `? Set(A, "length", ℱ(k), true)`.
      2. Return `A`.
    - v. Let `nextValue` be `? IteratorValue(next)`.
    - vi. If `mapping` is **true**, then
      1. Let `mappedValue` be `Completion(Call(mapfn, thisArg, « nextValue, ℱ(k) »))`.
      2. `IfAbruptCloseIterator(mappedValue, iteratorRecord)`.
    - vii. Else, let `mappedValue` be `nextValue`.
    - viii. Let `defineStatus` be `Completion(CreateDataPropertyOrThrow(A, Pk, mappedValue))`.
    - ix. `IfAbruptCloseIterator(defineStatus, iteratorRecord)`.
    - x. Set `k` to `k + 1`.
6. NOTE: `items` is not an Iterable so assume it is an array-like object.
7. Let `arrayLike` be `! ToObject(items)`.
8. Let `len` be `? LengthOfArrayLike(arrayLike)`.
9. If `IsConstructor(C)` is **true**, then
  - a. Let `A` be `? Construct(C, « ℱ(len) »)`.
10. Else,
  - a. Let `A` be `? ArrayCreate(len)`.
11. Let `k` be 0.
12. Repeat, while `k < len`,
  - a. Let `Pk` be `! ToString(ℱ(k))`.

- b. Let *kValue* be ? *Get*(*arrayLike*, *Pk*).
  - c. If *mapping* is **true**, then
    - i. Let *mappedValue* be ? *Call*(*mapfn*, *thisArg*, « *kValue*,  $\mathbb{F}(k)$  »).
  - d. Else, let *mappedValue* be *kValue*.
  - e. Perform ? *CreateDataPropertyOrThrow*(*A*, *Pk*, *mappedValue*).
  - f. Set *k* to *k* + 1.
13. Perform ? *Set*(*A*, "length",  $\mathbb{F}(\textit{len})$ , **true**).
  14. Return *A*.

**NOTE** This method is an intentionally generic factory method; it does not require that its **this** value be the Array **constructor**. Therefore it can be transferred to or inherited by any other **constructors** that may be called with a single numeric argument.

### 23.1.2.2 Array.isArray ( *arg* )

This function performs the following steps when called:

1. Return ? *isArray*(*arg*).

### 23.1.2.3 Array.of ( ...*items* )

This method performs the following steps when called:

1. Let *len* be the number of elements in *items*.
2. Let *lenNumber* be  $\mathbb{F}(\textit{len})$ .
3. Let *C* be the **this** value.
4. If *IsConstructor*(*C*) is **true**, then
  - a. Let *A* be ? *Construct*(*C*, « *lenNumber* »).
5. Else,
  - a. Let *A* be ? *ArrayCreate*(*len*).
6. Let *k* be 0.
7. Repeat, while *k* < *len*,
  - a. Let *kValue* be *items*[*k*].
  - b. Let *Pk* be ! *ToString*( $\mathbb{F}(k)$ ).
  - c. Perform ? *CreateDataPropertyOrThrow*(*A*, *Pk*, *kValue*).
  - d. Set *k* to *k* + 1.
8. Perform ? *Set*(*A*, "length", *lenNumber*, **true**).
9. Return *A*.

**NOTE** This method is an intentionally generic factory method; it does not require that its **this** value be the Array **constructor**. Therefore it can be transferred to or inherited by other **constructors** that may be called with a single numeric argument.

### 23.1.2.4 Array.prototype

The value of **Array.prototype** is the **Array prototype object**.

This property has the attributes { **[[Writable]]**: **false**, **[[Enumerable]]**: **false**, **[[Configurable]]**: **false** }.

### 23.1.2.5 get Array [ @@species ]

**Array[@@species]** is an [accessor property](#) whose set accessor function is **undefined**. Its get accessor function performs the following steps when called:

1. Return the **this** value.

The value of the "name" property of this function is "get [Symbol.species]".

**NOTE** Array prototype methods normally use their **this** value's [constructor](#) to create a derived object. However, a subclass [constructor](#) may over-ride that default behaviour by redefining its @@species property.

### 23.1.3 Properties of the Array Prototype Object

The *Array prototype object*:

- is %Array.prototype%.
- is an [Array exotic object](#) and has the internal methods specified for such objects.
- has a "length" property whose initial value is +0<sub>F</sub> and whose attributes are { [[Writable]]: **true**, [[Enumerable]]: **false**, [[Configurable]]: **false** }.
- has a [[Prototype]] internal slot whose value is %Object.prototype%.

**NOTE** The Array prototype object is specified to be an [Array exotic object](#) to ensure compatibility with ECMAScript code that was created prior to the ECMAScript 2015 specification.

#### 23.1.3.1 Array.prototype.at ( *index* )

1. Let *O* be ? [ToObject](#)(**this** value).
2. Let *len* be ? [LengthOfArrayLike](#)(*O*).
3. Let *relativeIndex* be ? [ToIntegerOrInfinity](#)(*index*).
4. If *relativeIndex* ≥ 0, then
  - a. Let *k* be *relativeIndex*.
5. Else,
  - a. Let *k* be *len* + *relativeIndex*.
6. If *k* < 0 or *k* ≥ *len*, return **undefined**.
7. Return ? [Get](#)(*O*, ! [ToString](#)( $\mathbb{F}(k)$ )).

#### 23.1.3.2 Array.prototype.concat ( ...*items* )

This method returns an array containing the array elements of the object followed by the array elements of each argument.

It performs the following steps when called:

1. Let *O* be ? [ToObject](#)(**this** value).
2. Let *A* be ? [ArraySpeciesCreate](#)(*O*, 0).
3. Let *n* be 0.
4. Prepend *O* to *items*.
5. For each element *E* of *items*, do
  - a. Let *spreadable* be ? [IsConcatSpreadable](#)(*E*).
  - b. If *spreadable* is **true**, then

- i. Let *len* be ? LengthOfArrayLike(*E*).
- ii. If  $n + len > 2^{53} - 1$ , throw a **TypeError** exception.
- iii. Let *k* be 0.
- iv. Repeat, while  $k < len$ ,
  1. Let *P* be ! ToString( $\mathbb{F}(k)$ ).
  2. Let *exists* be ? HasProperty(*E*, *P*).
  3. If *exists* is **true**, then
    - a. Let *subElement* be ? Get(*E*, *P*).
    - b. Perform ? CreateDataPropertyOrThrow(*A*, ! ToString( $\mathbb{F}(n)$ ), *subElement*).
  4. Set *n* to  $n + 1$ .
  5. Set *k* to  $k + 1$ .
- c. Else,
  - i. NOTE: *E* is added as a single item rather than spread.
  - ii. If  $n \geq 2^{53} - 1$ , throw a **TypeError** exception.
  - iii. Perform ? CreateDataPropertyOrThrow(*A*, ! ToString( $\mathbb{F}(n)$ ), *E*).
  - iv. Set *n* to  $n + 1$ .
6. Perform ? Set(*A*, "length",  $\mathbb{F}(n)$ , **true**).
7. Return *A*.

The "length" property of this method is 1<sub>F</sub>.

NOTE 1 The explicit setting of the "length" property in step 6 is necessary to ensure that its value is correct in situations where the trailing elements of the result Array are not present.

NOTE 2 This method is intentionally generic; it does not require that its **this** value be an Array. Therefore it can be transferred to other kinds of objects for use as a method.

### 23.1.3.2.1 IsConcatSpreadable ( *O* )

The abstract operation IsConcatSpreadable takes argument *O* (an ECMAScript language value) and returns either a normal completion containing a Boolean or a throw completion. It performs the following steps when called:

1. If *O* is not an Object, return **false**.
2. Let *spreadable* be ? Get(*O*, @@isConcatSpreadable).
3. If *spreadable* is not **undefined**, return ToBoolean(*spreadable*).
4. Return ? IsArray(*O*).

### 23.1.3.3 Array.prototype.constructor

The initial value of `Array.prototype.constructor` is %Array%.

### 23.1.3.4 Array.prototype.copyWithin ( *target*, *start* [ , *end* ] )

NOTE 1 The *end* argument is optional. If it is not provided, the length of the **this** value is used.

NOTE 2 If *target* is negative, it is treated as  $length + target$  where *length* is the length of the array. If *start* is negative, it is treated as  $length + start$ . If *end* is negative, it is treated as  $length + end$ .

This method performs the following steps when called:

1. Let *O* be ? **ToObject**(**this** value).
2. Let *len* be ? **LengthOfArrayLike**(*O*).
3. Let *relativeTarget* be ? **ToIntegerOrInfinity**(*target*).
4. If *relativeTarget* =  $-\infty$ , let *to* be 0.
5. Else if *relativeTarget* < 0, let *to* be **max**(*len* + *relativeTarget*, 0).
6. Else, let *to* be **min**(*relativeTarget*, *len*).
7. Let *relativeStart* be ? **ToIntegerOrInfinity**(*start*).
8. If *relativeStart* =  $-\infty$ , let *from* be 0.
9. Else if *relativeStart* < 0, let *from* be **max**(*len* + *relativeStart*, 0).
10. Else, let *from* be **min**(*relativeStart*, *len*).
11. If *end* is **undefined**, let *relativeEnd* be *len*; else let *relativeEnd* be ? **ToIntegerOrInfinity**(*end*).
12. If *relativeEnd* =  $-\infty$ , let *final* be 0.
13. Else if *relativeEnd* < 0, let *final* be **max**(*len* + *relativeEnd*, 0).
14. Else, let *final* be **min**(*relativeEnd*, *len*).
15. Let *count* be **min**(*final* - *from*, *len* - *to*).
16. If *from* < *to* and *to* < *from* + *count*, then
  - a. Let *direction* be -1.
  - b. Set *from* to *from* + *count* - 1.
  - c. Set *to* to *to* + *count* - 1.
17. Else,
  - a. Let *direction* be 1.
18. Repeat, while *count* > 0,
  - a. Let *fromKey* be ! **Tostring**(**ℱ**(*from*)).
  - b. Let *toKey* be ! **Tostring**(**ℱ**(*to*)).
  - c. Let *fromPresent* be ? **HasProperty**(*O*, *fromKey*).
  - d. If *fromPresent* is **true**, then
    - i. Let *fromVal* be ? **Get**(*O*, *fromKey*).
    - ii. Perform ? **Set**(*O*, *toKey*, *fromVal*, **true**).
  - e. Else,
    - i. **Assert**: *fromPresent* is **false**.
    - ii. Perform ? **DeletePropertyOrThrow**(*O*, *toKey*).
  - f. Set *from* to *from* + *direction*.
  - g. Set *to* to *to* + *direction*.
  - h. Set *count* to *count* - 1.
19. Return *O*.

**NOTE 3** This method is intentionally generic; it does not require that its **this** value be an Array. Therefore it can be transferred to other kinds of objects for use as a method.

### 23.1.3.5 Array.prototype.entries ( )

This method performs the following steps when called:

1. Let *O* be ? **ToObject**(**this** value).
2. Return **CreateArrayIterator**(*O*, key+value).

### 23.1.3.6 Array.prototype.every ( *callbackfn* [ , *thisArg* ] )

NOTE 1 *callbackfn* should be a function that accepts three arguments and returns a value that is coercible to a Boolean value. **every** calls *callbackfn* once for each element present in the array, in ascending order, until it finds one where *callbackfn* returns **false**. If such an element is found, **every** immediately returns **false**. Otherwise, if *callbackfn* returned **true** for all elements, **every** will return **true**. *callbackfn* is called only for elements of the array which actually exist; it is not called for missing elements of the array.

If a *thisArg* parameter is provided, it will be used as the **this** value for each invocation of *callbackfn*. If it is not provided, **undefined** is used instead.

*callbackfn* is called with three arguments: the value of the element, the index of the element, and the object being traversed.

**every** does not directly mutate the object on which it is called but the object may be mutated by the calls to *callbackfn*.

The range of elements processed by **every** is set before the first call to *callbackfn*. Elements which are appended to the array after the call to **every** begins will not be visited by *callbackfn*. If existing elements of the array are changed, their value as passed to *callbackfn* will be the value at the time **every** visits them; elements that are deleted after the call to **every** begins and before being visited are not visited. **every** acts like the "for all" quantifier in mathematics. In particular, for an empty array, it returns **true**.

This method performs the following steps when called:

1. Let *O* be ? **ToObject**(**this** value).
2. Let *len* be ? **LengthOfArrayLike**(*O*).
3. If **IsCallable**(*callbackfn*) is **false**, throw a **TypeError** exception.
4. Let *k* be 0.
5. Repeat, while *k* < *len*,
  - a. Let *Pk* be ! **ToString**(**ℱ**(*k*)).
  - b. Let *kPresent* be ? **HasProperty**(*O*, *Pk*).
  - c. If *kPresent* is **true**, then
    - i. Let *kValue* be ? **Get**(*O*, *Pk*).
    - ii. Let *testResult* be **ToBoolean**(? **Call**(*callbackfn*, *thisArg*, « *kValue*, **ℱ**(*k*), *O* »)).
    - iii. If *testResult* is **false**, return **false**.
  - d. Set *k* to *k* + 1.
6. Return **true**.

NOTE 2 This method is intentionally generic; it does not require that its **this** value be an Array. Therefore it can be transferred to other kinds of objects for use as a method.

### 23.1.3.7 Array.prototype.fill ( *value* [ , *start* [ , *end* ] ] )

NOTE 1 The *start* argument is optional. If it is not provided, **+0**<sub>ℱ</sub> is used.

The *end* argument is optional. If it is not provided, the length of the **this** value is used.

NOTE 2 If *start* is negative, it is treated as *length* + *start* where *length* is the length of the array. If *end* is negative, it is treated as *length* + *end*.

This method performs the following steps when called:

1. Let *O* be ? **ToObject**(**this** value).
2. Let *len* be ? **LengthOfArrayLike**(*O*).
3. Let *relativeStart* be ? **ToIntegerOrInfinity**(*start*).
4. If *relativeStart* =  $-\infty$ , let *k* be 0.
5. Else if *relativeStart* < 0, let *k* be **max**(*len* + *relativeStart*, 0).
6. Else, let *k* be **min**(*relativeStart*, *len*).
7. If *end* is **undefined**, let *relativeEnd* be *len*; else let *relativeEnd* be ? **ToIntegerOrInfinity**(*end*).
8. If *relativeEnd* =  $-\infty$ , let *final* be 0.
9. Else if *relativeEnd* < 0, let *final* be **max**(*len* + *relativeEnd*, 0).
10. Else, let *final* be **min**(*relativeEnd*, *len*).
11. Repeat, while *k* < *final*,
  - a. Let *Pk* be ! **Tostring**(**F**(*k*)).
  - b. Perform ? **Set**(*O*, *Pk*, *value*, **true**).
  - c. Set *k* to *k* + 1.
12. Return *O*.

**NOTE 3** This method is intentionally generic; it does not require that its **this** value be an Array. Therefore it can be transferred to other kinds of objects for use as a method.

### 23.1.3.8 **Array.prototype.filter** ( *callbackfn* [ , *thisArg* ] )

**NOTE 1** *callbackfn* should be a function that accepts three arguments and returns a value that is coercible to a Boolean value. **filter** calls *callbackfn* once for each element in the array, in ascending order, and constructs a new array of all the values for which *callbackfn* returns **true**. *callbackfn* is called only for elements of the array which actually exist; it is not called for missing elements of the array.

If a *thisArg* parameter is provided, it will be used as the **this** value for each invocation of *callbackfn*. If it is not provided, **undefined** is used instead.

*callbackfn* is called with three arguments: the value of the element, the index of the element, and the object being traversed.

**filter** does not directly mutate the object on which it is called but the object may be mutated by the calls to *callbackfn*.

The range of elements processed by **filter** is set before the first call to *callbackfn*. Elements which are appended to the array after the call to **filter** begins will not be visited by *callbackfn*. If existing elements of the array are changed their value as passed to *callbackfn* will be the value at the time **filter** visits them; elements that are deleted after the call to **filter** begins and before being visited are not visited.

This method performs the following steps when called:

1. Let *O* be ? **ToObject**(**this** value).
2. Let *len* be ? **LengthOfArrayLike**(*O*).
3. If **IsCallable**(*callbackfn*) is **false**, throw a **TypeError** exception.
4. Let *A* be ? **ArraySpeciesCreate**(*O*, 0).
5. Let *k* be 0.
6. Let *to* be 0.
7. Repeat, while *k* < *len*,



- a. Let *Pk* be ! ToString( $\mathbb{F}(k)$ ).
  - b. Let *kPresent* be ? HasProperty(*O*, *Pk*).
  - c. If *kPresent* is **true**, then
    - i. Let *kValue* be ? Get(*O*, *Pk*).
    - ii. Let *selected* be ToBoolean(? Call(*callbackfn*, *thisArg*, « *kValue*,  $\mathbb{F}(k)$ , *O* »)).
    - iii. If *selected* is **true**, then
      1. Perform ? CreateDataPropertyOrThrow(*A*, ! ToString( $\mathbb{F}(to)$ ), *kValue*).
      2. Set *to* to *to* + 1.
  - d. Set *k* to *k* + 1.
8. Return *A*.

NOTE 2 This method is intentionally generic; it does not require that its **this** value be an Array. Therefore it can be transferred to other kinds of objects for use as a method.

### 23.1.3.9 Array.prototype.find ( *predicate* [ , *thisArg* ] )

NOTE 1 This method calls *predicate* once for each element of the array, in ascending index order, until it finds one where *predicate* returns a value that coerces to **true**. If such an element is found, **find** immediately returns that element value. Otherwise, **find** returns **undefined**.

See [FindViaPredicate](#) for additional information.

This method performs the following steps when called:

1. Let *O* be ? ToObject(**this** value).
2. Let *len* be ? LengthOfArrayLike(*O*).
3. Let *findRec* be ? FindViaPredicate(*O*, *len*, ascending, *predicate*, *thisArg*).
4. Return *findRec*.[[Value]].

NOTE 2 This method is intentionally generic; it does not require that its **this** value be an Array. Therefore it can be transferred to other kinds of objects for use as a method.

### 23.1.3.10 Array.prototype.findIndex ( *predicate* [ , *thisArg* ] )

NOTE 1 This method calls *predicate* once for each element of the array, in ascending index order, until it finds one where *predicate* returns a value that coerces to **true**. If such an element is found, **findIndex** immediately returns the index of that element value. Otherwise, **findIndex** returns -1.

See [FindViaPredicate](#) for additional information.

This method performs the following steps when called:

1. Let *O* be ? ToObject(**this** value).
2. Let *len* be ? LengthOfArrayLike(*O*).
3. Let *findRec* be ? FindViaPredicate(*O*, *len*, ascending, *predicate*, *thisArg*).
4. Return *findRec*.[[Index]].

NOTE 2 This method is intentionally generic; it does not require that its **this** value be an Array. Therefore it can be transferred to other kinds of objects for use as a method.

### 23.1.3.11 Array.prototype.findLast ( *predicate* [ , *thisArg* ] )

NOTE 1 This method calls *predicate* once for each element of the array, in descending index order, until it finds one where *predicate* returns a value that coerces to **true**. If such an element is found, **findLast** immediately returns that element value. Otherwise, **findLast** returns **undefined**.

See [FindViaPredicate](#) for additional information.

This method performs the following steps when called:

1. Let *O* be ? [ToObject](#)(**this** value).
2. Let *len* be ? [LengthOfArrayLike](#)(*O*).
3. Let *findRec* be ? [FindViaPredicate](#)(*O*, *len*, descending, *predicate*, *thisArg*).
4. Return *findRec*.[[Value]].

NOTE 2 This method is intentionally generic; it does not require that its **this** value be an Array object. Therefore it can be transferred to other kinds of objects for use as a method.

### 23.1.3.12 Array.prototype.findLastIndex ( *predicate* [ , *thisArg* ] )

NOTE 1 This method calls *predicate* once for each element of the array, in descending index order, until it finds one where *predicate* returns a value that coerces to **true**. If such an element is found, **findLastIndex** immediately returns the index of that element value. Otherwise, **findLastIndex** returns -1.

See [FindViaPredicate](#) for additional information.

This method performs the following steps when called:

1. Let *O* be ? [ToObject](#)(**this** value).
2. Let *len* be ? [LengthOfArrayLike](#)(*O*).
3. Let *findRec* be ? [FindViaPredicate](#)(*O*, *len*, descending, *predicate*, *thisArg*).
4. Return *findRec*.[[Index]].

NOTE 2 This method is intentionally generic; it does not require that its **this** value be an Array object. Therefore it can be transferred to other kinds of objects for use as a method.

#### 23.1.3.12.1 FindViaPredicate ( *O*, *len*, *direction*, *predicate*, *thisArg* )

The abstract operation [FindViaPredicate](#) takes arguments *O* (an Object), *len* (a non-negative integer), *direction* (ascending or descending), *predicate* (an ECMAScript language value), and *thisArg* (an ECMAScript language value) and returns either a normal completion containing a Record with fields [[Index]] (an integral Number) and [[Value]] (an ECMAScript language value) or a throw completion.

*O* should be an array-like object or a TypedArray. This operation calls *predicate* once for each element of *O*, in either ascending index order or descending index order (as indicated by *direction*), until it finds one where *predicate* returns a value that coerces to **true**. At that point, this operation returns a Record that gives the

index and value of the element found. If no such element is found, this operation returns a **Record** that specifies **-1<sub>F</sub>** for the index and **undefined** for the value.

*predicate* should be a function. When called for an element of the array, it is passed three arguments: the value of the element, the index of the element, and the object being traversed. Its return value will be coerced to a Boolean value.

*thisArg* will be used as the **this** value for each invocation of *predicate*.

This operation does not directly mutate the object on which it is called, but the object may be mutated by the calls to *predicate*.

The range of elements processed is set before the first call to *predicate*, just before the traversal begins. Elements that are appended to the array after this will not be visited by *predicate*. If existing elements of the array are changed, their value as passed to *predicate* will be the value at the time that this operation visits them. Elements that are deleted after traversal begins and before being visited are still visited and are either looked up from the prototype or are **undefined**.

It performs the following steps when called:

1. If **IsCallable**(*predicate*) is **false**, throw a **TypeError** exception.
2. If *direction* is ascending, then
  - a. Let *indices* be a **List** of the **integers** in the **interval** from 0 (inclusive) to *len* (exclusive), in ascending order.
3. Else,
  - a. Let *indices* be a **List** of the **integers** in the **interval** from 0 (inclusive) to *len* (exclusive), in descending order.
4. For each **integer** *k* of *indices*, do
  - a. Let *Pk* be ! **Tostring**( $\mathbb{F}(k)$ ).
  - b. NOTE: If *O* is a **TypedArray**, the following invocation of **Get** will return a **normal completion**.
  - c. Let *kValue* be ? **Get**(*O*, *Pk*).
  - d. Let *testResult* be ? **Call**(*predicate*, *thisArg*, « *kValue*,  $\mathbb{F}(k)$ , *O* »).
  - e. If **ToBoolean**(*testResult*) is **true**, return the **Record** { **[[Index]]**:  $\mathbb{F}(k)$ , **[[Value]]**: *kValue* }.
5. Return the **Record** { **[[Index]]**: **-1<sub>F</sub>**, **[[Value]]**: **undefined** }.

### 23.1.3.13 Array.prototype.flat ( [ *depth* ] )

This method performs the following steps when called:

1. Let *O* be ? **ToObject**(**this** value).
2. Let *sourceLen* be ? **LengthOfArrayLike**(*O*).
3. Let *depthNum* be 1.
4. If *depth* is not **undefined**, then
  - a. Set *depthNum* to ? **ToIntegerOrInfinity**(*depth*).
  - b. If *depthNum* < 0, set *depthNum* to 0.
5. Let *A* be ? **ArraySpeciesCreate**(*O*, 0).
6. Perform ? **FlattenIntoArray**(*A*, *O*, *sourceLen*, 0, *depthNum*).
7. Return *A*.

#### 23.1.3.13.1 FlattenIntoArray(*target*, *source*, *sourceLen*, *start*, *depth* [ , *mapperFunction* [ , *thisArg* ] ] )

The abstract operation **FlattenIntoArray** takes arguments *target* (an **Object**), *source* (an **Object**), *sourceLen* (a non-negative **integer**), *start* (a non-negative **integer**), and *depth* (a non-negative **integer** or  $+\infty$ ) and optional arguments *mapperFunction* (a **function** object) and *thisArg* (an **ECMAScript language value**) and

returns either a [normal completion](#) containing a non-negative [integer](#) or a [throw completion](#). It performs the following steps when called:

1. **Assert**: If *mapperFunction* is present, then `IsCallable(mapperFunction)` is **true**, *thisArg* is present, and *depth* is 1.
2. Let *targetIndex* be *start*.
3. Let *sourceIndex* be **+0**<sub>F</sub>.
4. Repeat, while  $\mathbb{R}(\textit{sourceIndex}) < \textit{sourceLen}$ ,
  - a. Let *P* be `! ToString(sourceIndex)`.
  - b. Let *exists* be `? HasProperty(source, P)`.
  - c. If *exists* is **true**, then
    - i. Let *element* be `? Get(source, P)`.
    - ii. If *mapperFunction* is present, then
      1. Set *element* to `? Call(mapperFunction, thisArg, « element, sourceIndex, source »)`.
    - iii. Let *shouldFlatten* be **false**.
    - iv. If *depth* > 0, then
      1. Set *shouldFlatten* to `? IsArray(element)`.
    - v. If *shouldFlatten* is **true**, then
      1. If *depth* = **+∞**, let *newDepth* be **+∞**.
      2. Else, let *newDepth* be *depth* - 1.
      3. Let *elementLen* be `? LengthOfArrayLike(element)`.
      4. Set *targetIndex* to `? FlattenIntoArray(target, element, elementLen, targetIndex, newDepth)`.
    - vi. Else,
      1. If *targetIndex* ≥ 2<sup>53</sup> - 1, throw a **TypeError** exception.
      2. Perform `? CreateDataPropertyOrThrow(target, ! ToString(IF(targetIndex)), element)`.
      3. Set *targetIndex* to *targetIndex* + 1.
  - d. Set *sourceIndex* to *sourceIndex* + **1**<sub>F</sub>.
5. Return *targetIndex*.

### 23.1.3.14 Array.prototype.flatMap ( *mapperFunction* [ , *thisArg* ] )

This method performs the following steps when called:

1. Let *O* be `? ToObject(this value)`.
2. Let *sourceLen* be `? LengthOfArrayLike(O)`.
3. If `IsCallable(mapperFunction)` is **false**, throw a **TypeError** exception.
4. Let *A* be `? ArraySpeciesCreate(O, 0)`.
5. Perform `? FlattenIntoArray(A, O, sourceLen, 0, 1, mapperFunction, thisArg)`.
6. Return *A*.

### 23.1.3.15 Array.prototype.forEach ( *callbackfn* [ , *thisArg* ] )

NOTE 1 *callbackfn* should be a function that accepts three arguments. **forEach** calls *callbackfn* once for each element present in the array, in ascending order. *callbackfn* is called only for elements of the array which actually exist; it is not called for missing elements of the array.

If a *thisArg* parameter is provided, it will be used as the **this** value for each invocation of *callbackfn*. If it is not provided, **undefined** is used instead.

*callbackfn* is called with three arguments: the value of the element, the index of the element, and the object being traversed.

**forEach** does not directly mutate the object on which it is called but the object may be mutated by the calls to *callbackfn*.

The range of elements processed by **forEach** is set before the first call to *callbackfn*. Elements which are appended to the array after the call to **forEach** begins will not be visited by *callbackfn*. If existing elements of the array are changed, their value as passed to *callbackfn* will be the value at the time **forEach** visits them; elements that are deleted after the call to **forEach** begins and before being visited are not visited.

This method performs the following steps when called:

1. Let *O* be ? **ToObject**(**this** value).
2. Let *len* be ? **LengthOfArrayLike**(*O*).
3. If **IsCallable**(*callbackfn*) is **false**, throw a **TypeError** exception.
4. Let *k* be 0.
5. Repeat, while *k* < *len*,
  - a. Let *Pk* be ! **ToString**( $\mathbb{F}(k)$ ).
  - b. Let *kPresent* be ? **HasProperty**(*O*, *Pk*).
  - c. If *kPresent* is **true**, then
    - i. Let *kValue* be ? **Get**(*O*, *Pk*).
    - ii. Perform ? **Call**(*callbackfn*, *thisArg*, « *kValue*,  $\mathbb{F}(k)$ , *O* »).
  - d. Set *k* to *k* + 1.
6. Return **undefined**.

NOTE 2 This method is intentionally generic; it does not require that its **this** value be an Array. Therefore it can be transferred to other kinds of objects for use as a method.

### 23.1.3.16 Array.prototype.includes ( *searchElement* [ , *fromIndex* ] )

NOTE 1 This method compares *searchElement* to the elements of the array, in ascending order, using the **SameValueZero** algorithm, and if found at any position, returns **true**; otherwise, it returns **false**.

The optional second argument *fromIndex* defaults to **+0<sub>F</sub>** (i.e. the whole array is searched). If it is greater than or equal to the length of the array, **false** is returned, i.e. the array will not be searched. If it is less than **-0<sub>F</sub>**, it is used as the offset from the end of the array to compute *fromIndex*. If the computed index is less than or equal to **+0<sub>F</sub>**, the whole array will be searched.

This method performs the following steps when called:

1. Let *O* be ? [ToObject](#)(**this** value).
2. Let *len* be ? [LengthOfArrayLike](#)(*O*).
3. If *len* = 0, return **false**.
4. Let *n* be ? [ToIntegerOrInfinity](#)(*fromIndex*).
5. **Assert**: If *fromIndex* is **undefined**, then *n* is 0.
6. If *n* =  $+\infty$ , return **false**.
7. Else if *n* =  $-\infty$ , set *n* to 0.
8. If *n*  $\geq$  0, then
  - a. Let *k* be *n*.
9. Else,
  - a. Let *k* be *len* + *n*.
  - b. If *k* < 0, set *k* to 0.
10. Repeat, while *k* < *len*,
  - a. Let *elementK* be ? [Get](#)(*O*, ! [ToString](#)( $\mathbb{F}(k)$ )).
  - b. If [SameValueZero](#)(*searchElement*, *elementK*) is **true**, return **true**.
  - c. Set *k* to *k* + 1.
11. Return **false**.

**NOTE 2** This method is intentionally generic; it does not require that its **this** value be an Array. Therefore it can be transferred to other kinds of objects for use as a method.

**NOTE 3** This method intentionally differs from the similar [indexOf](#) method in two ways. First, it uses the [SameValueZero](#) algorithm, instead of [IsStrictlyEqual](#), allowing it to detect **NaN** array elements. Second, it does not skip missing array elements, instead treating them as **undefined**.

### 23.1.3.17 [Array.prototype.indexOf](#) ( *searchElement* [ , *fromIndex* ] )

This method compares *searchElement* to the elements of the array, in ascending order, using the [IsStrictlyEqual](#) algorithm, and if found at one or more indices, returns the smallest such index; otherwise, it returns  $-1_{\mathbb{F}}$ .

**NOTE 1** The optional second argument *fromIndex* defaults to  $+0_{\mathbb{F}}$  (i.e. the whole array is searched). If it is greater than or equal to the length of the array,  $-1_{\mathbb{F}}$  is returned, i.e. the array will not be searched. If it is less than  $-0_{\mathbb{F}}$ , it is used as the offset from the end of the array to compute *fromIndex*. If the computed index is less than or equal to  $+0_{\mathbb{F}}$ , the whole array will be searched.

This method performs the following steps when called:

1. Let *O* be ? [ToObject](#)(**this** value).
2. Let *len* be ? [LengthOfArrayLike](#)(*O*).
3. If *len* = 0, return  $-1_{\mathbb{F}}$ .
4. Let *n* be ? [ToIntegerOrInfinity](#)(*fromIndex*).
5. **Assert**: If *fromIndex* is **undefined**, then *n* is 0.
6. If *n* =  $+\infty$ , return  $-1_{\mathbb{F}}$ .
7. Else if *n* =  $-\infty$ , set *n* to 0.
8. If *n*  $\geq$  0, then

- a. Let *k* be *n*.
9. Else,
  - a. Let *k* be *len* + *n*.
  - b. If *k* < 0, set *k* to 0.
10. Repeat, while *k* < *len*,
  - a. Let *kPresent* be ? *HasProperty*(*O*, ! *ToString*(*F*(*k*))).
  - b. If *kPresent* is **true**, then
    - i. Let *elementK* be ? *Get*(*O*, ! *ToString*(*F*(*k*))).
    - ii. If *IsStrictlyEqual*(*searchElement*, *elementK*) is **true**, return *F*(*k*).
  - c. Set *k* to *k* + 1.
11. Return -1<sub>ƒ</sub>.

NOTE 2 This method is intentionally generic; it does not require that its **this** value be an Array. Therefore it can be transferred to other kinds of objects for use as a method.

### 23.1.3.18 Array.prototype.join ( *separator* )

This method converts the elements of the array to Strings, and then concatenates these Strings, separated by occurrences of the *separator*. If no separator is provided, a single comma is used as the separator.

It performs the following steps when called:

1. Let *O* be ? *ToObject*(**this** value).
2. Let *len* be ? *LengthOfArrayLike*(*O*).
3. If *separator* is **undefined**, let *sep* be ",".
4. Else, let *sep* be ? *ToString*(*separator*).
5. Let *R* be the empty String.
6. Let *k* be 0.
7. Repeat, while *k* < *len*,
  - a. If *k* > 0, set *R* to the *string-concatenation* of *R* and *sep*.
  - b. Let *element* be ? *Get*(*O*, ! *ToString*(*F*(*k*))).
  - c. If *element* is either **undefined** or **null**, let *next* be the empty String; otherwise, let *next* be ? *ToString*(*element*).
  - d. Set *R* to the *string-concatenation* of *R* and *next*.
  - e. Set *k* to *k* + 1.
8. Return *R*.

NOTE This method is intentionally generic; it does not require that its **this** value be an Array. Therefore, it can be transferred to other kinds of objects for use as a method.

### 23.1.3.19 Array.prototype.keys ( )

This method performs the following steps when called:

1. Let *O* be ? *ToObject*(**this** value).
2. Return *CreateArrayIterator*(*O*, key).

### 23.1.3.20 Array.prototype.lastIndexOf ( *searchElement* [ , *fromIndex* ] )

NOTE 1 This method compares *searchElement* to the elements of the array in descending order using the *IsStrictlyEqual* algorithm, and if found at one or more indices, returns the largest such

The optional second argument *fromIndex* defaults to the array's length minus one (i.e. the whole array is searched). If it is greater than or equal to the length of the array, the whole array will be searched. If it is less than  $-0_{\mathbb{F}}$ , it is used as the offset from the end of the array to compute *fromIndex*. If the computed index is less than or equal to  $+0_{\mathbb{F}}$ ,  $-1_{\mathbb{F}}$  is returned.

This method performs the following steps when called:

1. Let *O* be ? **ToObject**(**this** value).
2. Let *len* be ? **LengthOfArrayLike**(*O*).
3. If *len* = 0, return  $-1_{\mathbb{F}}$ .
4. If *fromIndex* is present, let *n* be ? **ToIntegerOrInfinity**(*fromIndex*); else let *n* be *len* - 1.
5. If *n* =  $-\infty$ , return  $-1_{\mathbb{F}}$ .
6. If *n* ≥ 0, then
  - a. Let *k* be **min**(*n*, *len* - 1).
7. Else,
  - a. Let *k* be *len* + *n*.
8. Repeat, while *k* ≥ 0,
  - a. Let *kPresent* be ? **HasProperty**(*O*, ! **ToString**( $\mathbb{F}(k)$ )).
  - b. If *kPresent* is **true**, then
    - i. Let *elementK* be ? **Get**(*O*, ! **ToString**( $\mathbb{F}(k)$ )).
    - ii. If **IsStrictlyEqual**(*searchElement*, *elementK*) is **true**, return  $\mathbb{F}(k)$ .
  - c. Set *k* to *k* - 1.
9. Return  $-1_{\mathbb{F}}$ .

NOTE 2 This method is intentionally generic; it does not require that its **this** value be an Array. Therefore it can be transferred to other kinds of objects for use as a method.

### 23.1.3.21 Array.prototype.map ( *callbackfn* [ , *thisArg* ] )

NOTE 1 *callbackfn* should be a function that accepts three arguments. **map** calls *callbackfn* once for each element in the array, in ascending order, and constructs a new Array from the results. *callbackfn* is called only for elements of the array which actually exist; it is not called for missing elements of the array.

If a *thisArg* parameter is provided, it will be used as the **this** value for each invocation of *callbackfn*. If it is not provided, **undefined** is used instead.

*callbackfn* is called with three arguments: the value of the element, the index of the element, and the object being traversed.

**map** does not directly mutate the object on which it is called but the object may be mutated by the calls to *callbackfn*.

The range of elements processed by **map** is set before the first call to *callbackfn*. Elements which are appended to the array after the call to **map** begins will not be visited by *callbackfn*. If existing elements of the array are changed, their value as passed to *callbackfn* will be the value at the time **map** visits them; elements that are deleted after the call to **map** begins and before being visited are not visited.

This method performs the following steps when called:



1. Let *O* be ? **ToObject**(**this** value).
2. Let *len* be ? **LengthOfArrayLike**(*O*).
3. If **IsCallable**(*callbackfn*) is **false**, throw a **TypeError** exception.
4. Let *A* be ? **ArraySpeciesCreate**(*O*, *len*).
5. Let *k* be 0.
6. Repeat, while *k* < *len*,
  - a. Let *Pk* be ! **ToString**(**ℱ**(*k*)).
  - b. Let *kPresent* be ? **HasProperty**(*O*, *Pk*).
  - c. If *kPresent* is **true**, then
    - i. Let *kValue* be ? **Get**(*O*, *Pk*).
    - ii. Let *mappedValue* be ? **Call**(*callbackfn*, *thisArg*, « *kValue*, **ℱ**(*k*), *O* »).
    - iii. Perform ? **CreateDataPropertyOrThrow**(*A*, *Pk*, *mappedValue*).
  - d. Set *k* to *k* + 1.
7. Return *A*.

NOTE 2 This method is intentionally generic; it does not require that its **this** value be an Array. Therefore it can be transferred to other kinds of objects for use as a method.

### 23.1.3.22 Array.prototype.pop ( )

NOTE 1 This method removes the last element of the array and returns it.

This method performs the following steps when called:

1. Let *O* be ? **ToObject**(**this** value).
2. Let *len* be ? **LengthOfArrayLike**(*O*).
3. If *len* = 0, then
  - a. Perform ? **Set**(*O*, "length", +0<sub>ℱ</sub>, **true**).
  - b. Return **undefined**.
4. Else,
  - a. **Assert**: *len* > 0.
  - b. Let *newLen* be **ℱ**(*len* - 1).
  - c. Let *index* be ! **ToString**(*newLen*).
  - d. Let *element* be ? **Get**(*O*, *index*).
  - e. Perform ? **DeletePropertyOrThrow**(*O*, *index*).
  - f. Perform ? **Set**(*O*, "length", *newLen*, **true**).
  - g. Return *element*.

NOTE 2 This method is intentionally generic; it does not require that its **this** value be an Array. Therefore it can be transferred to other kinds of objects for use as a method.

### 23.1.3.23 Array.prototype.push ( ...*items* )

NOTE 1 This method appends the arguments to the end of the array, in the order in which they appear. It returns the new length of the array.

This method performs the following steps when called:

1. Let *O* be ? **ToObject**(**this** value).

2. Let *len* be ? `LengthOfArrayLike(O)`.
3. Let *argCount* be the number of elements in *items*.
4. If  $len + argCount > 2^{53} - 1$ , throw a **TypeError** exception.
5. For each element *E* of *items*, do
  - a. Perform ? `Set(O, ! ToString(F(len)), E, true)`.
  - b. Set *len* to *len* + 1.
6. Perform ? `Set(O, "length", F(len), true)`.
7. Return `F(len)`.

The **"length"** property of this method is 1<sub>F</sub>.

NOTE 2 This method is intentionally generic; it does not require that its **this** value be an Array. Therefore it can be transferred to other kinds of objects for use as a method.

### 23.1.3.24 `Array.prototype.reduce ( callbackfn [ , initialValue ] )`

NOTE 1 *callbackfn* should be a function that takes four arguments. **reduce** calls the callback, as a function, once for each element after the first element present in the array, in ascending order.

*callbackfn* is called with four arguments: the *previousValue* (value from the previous call to *callbackfn*), the *currentValue* (value of the current element), the *currentIndex*, and the object being traversed. The first time that callback is called, the *previousValue* and *currentValue* can be one of two values. If an *initialValue* was supplied in the call to **reduce**, then *previousValue* will be *initialValue* and *currentValue* will be the first value in the array. If no *initialValue* was supplied, then *previousValue* will be the first value in the array and *currentValue* will be the second. It is a **TypeError** if the array contains no elements and *initialValue* is not provided.

**reduce** does not directly mutate the object on which it is called but the object may be mutated by the calls to *callbackfn*.

The range of elements processed by **reduce** is set before the first call to *callbackfn*. Elements that are appended to the array after the call to **reduce** begins will not be visited by *callbackfn*. If existing elements of the array are changed, their value as passed to *callbackfn* will be the value at the time **reduce** visits them; elements that are deleted after the call to **reduce** begins and before being visited are not visited.

This method performs the following steps when called:

1. Let *O* be ? `ToObject(this value)`.
2. Let *len* be ? `LengthOfArrayLike(O)`.
3. If `IsCallable(callbackfn)` is **false**, throw a **TypeError** exception.
4. If *len* = 0 and *initialValue* is not present, throw a **TypeError** exception.
5. Let *k* be 0.
6. Let *accumulator* be **undefined**.
7. If *initialValue* is present, then
  - a. Set *accumulator* to *initialValue*.
8. Else,
  - a. Let *kPresent* be **false**.
  - b. Repeat, while *kPresent* is **false** and *k* < *len*,
    - i. Let *Pk* be ! `ToString(F(k))`.
    - ii. Set *kPresent* to ? `HasProperty(O, Pk)`.
    - iii. If *kPresent* is **true**, then
      1. Set *accumulator* to ? `Get(O, Pk)`.
    - iv. Set *k* to *k* + 1.

- c. If *kPresent* is **false**, throw a **TypeError** exception.
- 9. Repeat, while *k* < *len*,
  - a. Let *Pk* be ! **To**String(**F**(*k*)).
  - b. Let *kPresent* be ? **HasProperty**(*O*, *Pk*).
  - c. If *kPresent* is **true**, then
    - i. Let *kValue* be ? **Get**(*O*, *Pk*).
    - ii. Set *accumulator* to ? **Call**(*callbackfn*, **undefined**, « *accumulator*, *kValue*, **F**(*k*), *O* »).
  - d. Set *k* to *k* + 1.
- 10. Return *accumulator*.

NOTE 2 This method is intentionally generic; it does not require that its **this** value be an Array. Therefore it can be transferred to other kinds of objects for use as a method.

### 23.1.3.25 Array.prototype.reduceRight ( *callbackfn* [ , *initialValue* ] )

NOTE 1 *callbackfn* should be a function that takes four arguments. **reduceRight** calls the callback, as a function, once for each element after the first element present in the array, in descending order.

*callbackfn* is called with four arguments: the *previousValue* (value from the previous call to *callbackfn*), the *currentValue* (value of the current element), the *currentIndex*, and the object being traversed. The first time the function is called, the *previousValue* and *currentValue* can be one of two values. If an *initialValue* was supplied in the call to **reduceRight**, then *previousValue* will be *initialValue* and *currentValue* will be the last value in the array. If no *initialValue* was supplied, then *previousValue* will be the last value in the array and *currentValue* will be the second-to-last value. It is a **TypeError** if the array contains no elements and *initialValue* is not provided.

**reduceRight** does not directly mutate the object on which it is called but the object may be mutated by the calls to *callbackfn*.

The range of elements processed by **reduceRight** is set before the first call to *callbackfn*. Elements that are appended to the array after the call to **reduceRight** begins will not be visited by *callbackfn*. If existing elements of the array are changed by *callbackfn*, their value as passed to *callbackfn* will be the value at the time **reduceRight** visits them; elements that are deleted after the call to **reduceRight** begins and before being visited are not visited.

This method performs the following steps when called:

1. Let *O* be ? **To**Object(**this** value).
2. Let *len* be ? **LengthOfArrayLike**(*O*).
3. If **IsCallable**(*callbackfn*) is **false**, throw a **TypeError** exception.
4. If *len* = 0 and *initialValue* is not present, throw a **TypeError** exception.
5. Let *k* be *len* - 1.
6. Let *accumulator* be **undefined**.
7. If *initialValue* is present, then
  - a. Set *accumulator* to *initialValue*.
8. Else,
  - a. Let *kPresent* be **false**.
  - b. Repeat, while *kPresent* is **false** and *k* ≥ 0,
    - i. Let *Pk* be ! **To**String(**F**(*k*)).
    - ii. Set *kPresent* to ? **HasProperty**(*O*, *Pk*).
    - iii. If *kPresent* is **true**, then

1. Set *accumulator* to ? *Get*(*O*, *Pk*).
- iv. Set *k* to *k* - 1.
- c. If *kPresent* is **false**, throw a **TypeError** exception.
9. Repeat, while *k* ≥ 0,
  - a. Let *Pk* be ! *ToString*(*F*(*k*)).
  - b. Let *kPresent* be ? *HasProperty*(*O*, *Pk*).
  - c. If *kPresent* is **true**, then
    - i. Let *kValue* be ? *Get*(*O*, *Pk*).
    - ii. Set *accumulator* to ? *Call*(*callbackfn*, **undefined**, « *accumulator*, *kValue*, *F*(*k*), *O* »).
  - d. Set *k* to *k* - 1.
10. Return *accumulator*.

NOTE 2 This method is intentionally generic; it does not require that its **this** value be an Array. Therefore it can be transferred to other kinds of objects for use as a method.

### 23.1.3.26 Array.prototype.reverse ( )

NOTE 1 This method rearranges the elements of the array so as to reverse their order. It returns the object as the result of the call.

This method performs the following steps when called:

1. Let *O* be ? *ToObject*(**this** value).
2. Let *len* be ? *LengthOfArrayLike*(*O*).
3. Let *middle* be *floor*(*len* / 2).
4. Let *lower* be 0.
5. Repeat, while *lower* ≠ *middle*,
  - a. Let *upper* be *len* - *lower* - 1.
  - b. Let *upperP* be ! *ToString*(*F*(*upper*)).
  - c. Let *lowerP* be ! *ToString*(*F*(*lower*)).
  - d. Let *lowerExists* be ? *HasProperty*(*O*, *lowerP*).
  - e. If *lowerExists* is **true**, then
    - i. Let *lowerValue* be ? *Get*(*O*, *lowerP*).
  - f. Let *upperExists* be ? *HasProperty*(*O*, *upperP*).
  - g. If *upperExists* is **true**, then
    - i. Let *upperValue* be ? *Get*(*O*, *upperP*).
  - h. If *lowerExists* is **true** and *upperExists* is **true**, then
    - i. Perform ? *Set*(*O*, *lowerP*, *upperValue*, **true**).
    - ii. Perform ? *Set*(*O*, *upperP*, *lowerValue*, **true**).
  - i. Else if *lowerExists* is **false** and *upperExists* is **true**, then
    - i. Perform ? *Set*(*O*, *lowerP*, *upperValue*, **true**).
    - ii. Perform ? *DeletePropertyOrThrow*(*O*, *upperP*).
  - j. Else if *lowerExists* is **true** and *upperExists* is **false**, then
    - i. Perform ? *DeletePropertyOrThrow*(*O*, *lowerP*).
    - ii. Perform ? *Set*(*O*, *upperP*, *lowerValue*, **true**).
  - k. Else,
    - i. **Assert**: *lowerExists* and *upperExists* are both **false**.
    - ii. NOTE: No action is required.
  - l. Set *lower* to *lower* + 1.
6. Return *O*.

NOTE 2 This method is intentionally generic; it does not require that its **this** value be an Array. Therefore, it can be transferred to other kinds of objects for use as a method.

### 23.1.3.27 Array.prototype.shift ( )

This method removes the first element of the array and returns it.

It performs the following steps when called:

1. Let *O* be ? **ToObject**(**this** value).
2. Let *len* be ? **LengthOfArrayLike**(*O*).
3. If *len* = 0, then
  - a. Perform ? **Set**(*O*, "length", +0<sub>F</sub>, **true**).
  - b. Return **undefined**.
4. Let *first* be ? **Get**(*O*, "0").
5. Let *k* be 1.
6. Repeat, while *k* < *len*,
  - a. Let *from* be ! **Tostring**(**F**(*k*)).
  - b. Let *to* be ! **Tostring**(**F**(*k* - 1)).
  - c. Let *fromPresent* be ? **HasProperty**(*O*, *from*).
  - d. If *fromPresent* is **true**, then
    - i. Let *fromVal* be ? **Get**(*O*, *from*).
    - ii. Perform ? **Set**(*O*, *to*, *fromVal*, **true**).
  - e. Else,
    - i. **Assert**: *fromPresent* is **false**.
    - ii. Perform ? **DeletePropertyOrThrow**(*O*, *to*).
  - f. Set *k* to *k* + 1.
7. Perform ? **DeletePropertyOrThrow**(*O*, ! **Tostring**(**F**(*len* - 1))).
8. Perform ? **Set**(*O*, "length", **F**(*len* - 1), **true**).
9. Return *first*.

NOTE This method is intentionally generic; it does not require that its **this** value be an Array. Therefore it can be transferred to other kinds of objects for use as a method.

### 23.1.3.28 Array.prototype.slice ( *start*, *end* )

This method returns an array containing the elements of the array from element *start* up to, but not including, element *end* (or through the end of the array if *end* is **undefined**). If *start* is negative, it is treated as *length* + *start* where *length* is the length of the array. If *end* is negative, it is treated as *length* + *end* where *length* is the length of the array.

It performs the following steps when called:

1. Let *O* be ? **ToObject**(**this** value).
2. Let *len* be ? **LengthOfArrayLike**(*O*).
3. Let *relativeStart* be ? **ToIntegerOrInfinity**(*start*).
4. If *relativeStart* =  $-\infty$ , let *k* be 0.
5. Else if *relativeStart* < 0, let *k* be **max**(*len* + *relativeStart*, 0).
6. Else, let *k* be **min**(*relativeStart*, *len*).
7. If *end* is **undefined**, let *relativeEnd* be *len*; else let *relativeEnd* be ? **ToIntegerOrInfinity**(*end*).

8. If *relativeEnd* =  $-\infty$ , let *final* be 0.
9. Else if *relativeEnd* < 0, let *final* be  $\max(\textit{len} + \textit{relativeEnd}, 0)$ .
10. Else, let *final* be  $\min(\textit{relativeEnd}, \textit{len})$ .
11. Let *count* be  $\max(\textit{final} - k, 0)$ .
12. Let *A* be ? *ArraySpeciesCreate*(*O*, *count*).
13. Let *n* be 0.
14. Repeat, while *k* < *final*,
  - a. Let *Pk* be ! *ToString*( $\mathbb{F}(k)$ ).
  - b. Let *kPresent* be ? *HasProperty*(*O*, *Pk*).
  - c. If *kPresent* is **true**, then
    - i. Let *kValue* be ? *Get*(*O*, *Pk*).
    - ii. Perform ? *CreateDataPropertyOrThrow*(*A*, ! *ToString*( $\mathbb{F}(n)$ ), *kValue*).
  - d. Set *k* to *k* + 1.
  - e. Set *n* to *n* + 1.
15. Perform ? *Set*(*A*, "length",  $\mathbb{F}(n)$ , **true**).
16. Return *A*.

NOTE 1 The explicit setting of the "length" property of the result Array in step 15 was necessary in previous editions of ECMAScript to ensure that its length was correct in situations where the trailing elements of the result Array were not present. Setting "length" became unnecessary starting in ES2015 when the result Array was initialized to its proper length rather than an empty Array but is carried forward to preserve backward compatibility.

NOTE 2 This method is intentionally generic; it does not require that its **this** value be an Array. Therefore it can be transferred to other kinds of objects for use as a method.

### 23.1.3.29 Array.prototype.some ( *callbackfn* [ , *thisArg* ] )

NOTE 1 *callbackfn* should be a function that accepts three arguments and returns a value that is coercible to a Boolean value. **some** calls *callbackfn* once for each element present in the array, in ascending order, until it finds one where *callbackfn* returns **true**. If such an element is found, **some** immediately returns **true**. Otherwise, **some** returns **false**. *callbackfn* is called only for elements of the array which actually exist; it is not called for missing elements of the array.

If a *thisArg* parameter is provided, it will be used as the **this** value for each invocation of *callbackfn*. If it is not provided, **undefined** is used instead.

*callbackfn* is called with three arguments: the value of the element, the index of the element, and the object being traversed.

**some** does not directly mutate the object on which it is called but the object may be mutated by the calls to *callbackfn*.

The range of elements processed by **some** is set before the first call to *callbackfn*. Elements that are appended to the array after the call to **some** begins will not be visited by *callbackfn*. If existing elements of the array are changed, their value as passed to *callbackfn* will be the value at the time that **some** visits them; elements that are deleted after the call to **some** begins and before being visited are not visited. **some** acts like the "exists" quantifier in mathematics. In particular, for an empty array, it returns **false**.

This method performs the following steps when called:

1. Let *O* be ? *ToObject*(**this** value).

2. Let *len* be ? [LengthOfArrayLike\(O\)](#).
3. If [IsCallable\(callbackfn\)](#) is **false**, throw a **TypeError** exception.
4. Let *k* be 0.
5. Repeat, while *k* < *len*,
  - a. Let *Pk* be ! [ToString\(ℱ\(\*k\*\)\)](#).
  - b. Let *kPresent* be ? [HasProperty\(O, Pk\)](#).
  - c. If *kPresent* is **true**, then
    - i. Let *kValue* be ? [Get\(O, Pk\)](#).
    - ii. Let *testResult* be [ToBoolean\(? Call\(callbackfn, thisArg, « kValue, ℱ\(\*k\*\), O »\)\)](#).
    - iii. If *testResult* is **true**, return **true**.
  - d. Set *k* to *k* + 1.
6. Return **false**.

NOTE 2 This method is intentionally generic; it does not require that its **this** value be an Array. Therefore it can be transferred to other kinds of objects for use as a method.

### 23.1.3.30 Array.prototype.sort ( *comparefn* )

This method sorts the elements of this array. The sort must be stable (that is, elements that compare equal must remain in their original order). If *comparefn* is not **undefined**, it should be a function that accepts two arguments *x* and *y* and returns a negative Number if *x* < *y*, a positive Number if *x* > *y*, or a zero otherwise.

It performs the following steps when called:

1. If *comparefn* is not **undefined** and [IsCallable\(comparefn\)](#) is **false**, throw a **TypeError** exception.
2. Let *obj* be ? [ToObject\(this value\)](#).
3. Let *len* be ? [LengthOfArrayLike\(obj\)](#).
4. Let *SortCompare* be a new [Abstract Closure](#) with parameters (*x*, *y*) that captures *comparefn* and performs the following steps when called:
  - a. Return ? [CompareArrayElements\(x, y, comparefn\)](#).
5. Let *sortedList* be ? [SortIndexedProperties\(obj, len, SortCompare, skip-holes\)](#).
6. Let *itemCount* be the number of elements in *sortedList*.
7. Let *j* be 0.
8. Repeat, while *j* < *itemCount*,
  - a. Perform ? [Set\(obj, ! ToString\(ℱ\(\*j\*\)\), sortedList\[\*j\*\], true\)](#).
  - b. Set *j* to *j* + 1.
9. NOTE: The call to [SortIndexedProperties](#) in step 5 uses skip-holes. The remaining indices are deleted to preserve the number of holes that were detected and excluded from the sort.
10. Repeat, while *j* < *len*,
  - a. Perform ? [DeletePropertyOrThrow\(obj, ! ToString\(ℱ\(\*j\*\)\)\)](#).
  - b. Set *j* to *j* + 1.
11. Return *obj*.

NOTE 1 Because non-existent property values always compare greater than **undefined** property values, and **undefined** always compares greater than any other value (see [CompareArrayElements](#)), **undefined** property values always sort to the end of the result, followed by non-existent property values.

NOTE 2 Method calls performed by the [ToString](#) abstract operations in steps 5 and 6 have the potential to cause *SortCompare* to not behave as a [consistent comparator](#).

NOTE 3 This method is intentionally generic; it does not require that its **this** value be an Array. Therefore, it can be transferred to other kinds of objects for use as a method.

### 23.1.3.30.1 SortIndexedProperties ( *obj*, *len*, *SortCompare*, *holes* )

The abstract operation SortIndexedProperties takes arguments *obj* (an Object), *len* (a non-negative integer), *SortCompare* (an Abstract Closure with two parameters), and *holes* (skip-holes or read-through-holes) and returns either a normal completion containing a List of ECMAScript language values or a throw completion. It performs the following steps when called:

1. Let *items* be a new empty List.
2. Let *k* be 0.
3. Repeat, while *k* < *len*,
  - a. Let *Pk* be ! ToString( $\mathbb{F}(k)$ ).
  - b. If *holes* is skip-holes, then
    - i. Let *kRead* be ? HasProperty(*obj*, *Pk*).
  - c. Else,
    - i. Assert: *holes* is read-through-holes.
    - ii. Let *kRead* be true.
  - d. If *kRead* is true, then
    - i. Let *kValue* be ? Get(*obj*, *Pk*).
    - ii. Append *kValue* to *items*.
  - e. Set *k* to *k* + 1.
4. Sort *items* using an implementation-defined sequence of calls to *SortCompare*. If any such call returns an abrupt completion, stop before performing any further calls to *SortCompare* and return that Completion Record.
5. Return *items*.

The *sort order* is the ordering of *items* after completion of step 4 of the algorithm above. The *sort order* is implementation-defined if *SortCompare* is not a consistent comparator for the elements of *items*. When SortIndexedProperties is invoked by Array.prototype.sort, the *sort order* is also implementation-defined if *comparefn* is undefined, and all applications of ToString, to any specific value passed as an argument to *SortCompare*, do not produce the same result.

Unless the *sort order* is specified to be implementation-defined, it must satisfy all of the following conditions:

- There must be some mathematical permutation  $\pi$  of the non-negative integers less than *itemCount*, such that for every non-negative integer *j* less than *itemCount*, the element old[*j*] is exactly the same as new[ $\pi(j)$ ].
- Then for all non-negative integers *j* and *k*, each less than *itemCount*, if  $\mathbb{R}(\text{SortCompare}(\text{old}[j], \text{old}[k])) < 0$ , then  $\pi(j) < \pi(k)$ .

Here the notation old[*j*] is used to refer to *items*[*j*] before step 4 is executed, and the notation new[*j*] to refer to *items*[*j*] after step 4 has been executed.

An abstract closure or function *comparator* is a consistent comparator for a set of values *S* if all of the requirements below are met for all values *a*, *b*, and *c* (possibly the same value) in the set *S*: The notation  $a <_C b$  means  $\mathbb{R}(\text{comparator}(a, b)) < 0$ ;  $a =_C b$  means  $\mathbb{R}(\text{comparator}(a, b)) = 0$ ; and  $a >_C b$  means  $\mathbb{R}(\text{comparator}(a, b)) > 0$ .

- Calling *comparator*(*a*, *b*) always returns the same value *v* when given a specific pair of values *a* and *b* as its two arguments. Furthermore, *v* is a Number, and *v* is not NaN. Note that this implies that exactly one of  $a <_C b$ ,  $a =_C b$ , and  $a >_C b$  will be true for a given pair of *a* and *b*.
- Calling *comparator*(*a*, *b*) does not modify *obj* or any object on *obj*'s prototype chain.
- $a =_C a$  (reflexivity)



- If  $a =_C b$ , then  $b =_C a$  (symmetry)
- If  $a =_C b$  and  $b =_C c$ , then  $a =_C c$  (transitivity of  $=_C$ )
- If  $a <_C b$  and  $b <_C c$ , then  $a <_C c$  (transitivity of  $<_C$ )
- If  $a >_C b$  and  $b >_C c$ , then  $a >_C c$  (transitivity of  $>_C$ )

NOTE The above conditions are necessary and sufficient to ensure that *comparator* divides the set *S* into equivalence classes and that these equivalence classes are totally ordered.

### 23.1.3.30.2 CompareArrayElements ( *x*, *y*, *comparefn* )

The abstract operation CompareArrayElements takes arguments *x* (an ECMAScript language value), *y* (an ECMAScript language value), and *comparefn* (a function object or **undefined**) and returns either a normal completion containing a Number or an abrupt completion. It performs the following steps when called:

1. If *x* and *y* are both **undefined**, return **+0**<sub>F</sub>.
2. If *x* is **undefined**, return **1**<sub>F</sub>.
3. If *y* is **undefined**, return **-1**<sub>F</sub>.
4. If *comparefn* is not **undefined**, then
  - a. Let *v* be ? **ToNumber**(? **Call**(*comparefn*, **undefined**, « *x*, *y* »)).
  - b. If *v* is **NaN**, return **+0**<sub>F</sub>.
  - c. Return *v*.
5. Let *xString* be ? **Tostring**(*x*).
6. Let *yString* be ? **Tostring**(*y*).
7. Let *xSmaller* be ! **IsLessThan**(*xString*, *yString*, **true**).
8. If *xSmaller* is **true**, return **-1**<sub>F</sub>.
9. Let *ySmaller* be ! **IsLessThan**(*yString*, *xString*, **true**).
10. If *ySmaller* is **true**, return **1**<sub>F</sub>.
11. Return **+0**<sub>F</sub>.

### 23.1.3.31 Array.prototype.splice ( *start*, *deleteCount*, ...*items* )

NOTE 1 This method deletes the *deleteCount* elements of the array starting at integer index *start* and replaces them with the elements of *items*. It returns an Array containing the deleted elements (if any).

This method performs the following steps when called:

1. Let *O* be ? **ToObject**(**this** value).
2. Let *len* be ? **LengthOfArrayLike**(*O*).
3. Let *relativeStart* be ? **ToIntegerOrInfinity**(*start*).
4. If *relativeStart* =  $-\infty$ , let *actualStart* be 0.
5. Else if *relativeStart* < 0, let *actualStart* be **max**(*len* + *relativeStart*, 0).
6. Else, let *actualStart* be **min**(*relativeStart*, *len*).
7. Let *itemCount* be the number of elements in *items*.
8. If *start* is not present, then
  - a. Let *actualDeleteCount* be 0.
9. Else if *deleteCount* is not present, then
  - a. Let *actualDeleteCount* be *len* - *actualStart*.
10. Else,
  - a. Let *dc* be ? **ToIntegerOrInfinity**(*deleteCount*).

- b. Let *actualDeleteCount* be the result of clamping *dc* between 0 and  $len - actualStart$ .
11. If  $len + itemCount - actualDeleteCount > 2^{53} - 1$ , throw a **TypeError** exception.
12. Let *A* be ? *ArraySpeciesCreate*(*O*, *actualDeleteCount*).
13. Let *k* be 0.
14. Repeat, while  $k < actualDeleteCount$ ,
  - a. Let *from* be ! *ToString*(*F*(*actualStart* + *k*)).
  - b. If ? *HasProperty*(*O*, *from*) is **true**, then
    - i. Let *fromValue* be ? *Get*(*O*, *from*).
    - ii. Perform ? *CreateDataPropertyOrThrow*(*A*, ! *ToString*(*F*(*k*)), *fromValue*).
  - c. Set *k* to *k* + 1.
15. Perform ? *Set*(*A*, "length", *F*(*actualDeleteCount*), **true**).
16. If  $itemCount < actualDeleteCount$ , then
  - a. Set *k* to *actualStart*.
  - b. Repeat, while  $k < (len - actualDeleteCount)$ ,
    - i. Let *from* be ! *ToString*(*F*(*k* + *actualDeleteCount*)).
    - ii. Let *to* be ! *ToString*(*F*(*k* + *itemCount*)).
    - iii. If ? *HasProperty*(*O*, *from*) is **true**, then
      1. Let *fromValue* be ? *Get*(*O*, *from*).
      2. Perform ? *Set*(*O*, *to*, *fromValue*, **true**).
    - iv. Else,
      1. Perform ? *DeletePropertyOrThrow*(*O*, *to*).
    - v. Set *k* to *k* + 1.
  - c. Set *k* to *len*.
  - d. Repeat, while  $k > (len - actualDeleteCount + itemCount)$ ,
    - i. Perform ? *DeletePropertyOrThrow*(*O*, ! *ToString*(*F*(*k* - 1))).
    - ii. Set *k* to *k* - 1.
17. Else if  $itemCount > actualDeleteCount$ , then
  - a. Set *k* to  $(len - actualDeleteCount)$ .
  - b. Repeat, while  $k > actualStart$ ,
    - i. Let *from* be ! *ToString*(*F*(*k* + *actualDeleteCount* - 1)).
    - ii. Let *to* be ! *ToString*(*F*(*k* + *itemCount* - 1)).
    - iii. If ? *HasProperty*(*O*, *from*) is **true**, then
      1. Let *fromValue* be ? *Get*(*O*, *from*).
      2. Perform ? *Set*(*O*, *to*, *fromValue*, **true**).
    - iv. Else,
      1. Perform ? *DeletePropertyOrThrow*(*O*, *to*).
    - v. Set *k* to *k* - 1.
18. Set *k* to *actualStart*.
19. For each element *E* of *items*, do
  - a. Perform ? *Set*(*O*, ! *ToString*(*F*(*k*)), *E*, **true**).
  - b. Set *k* to *k* + 1.
20. Perform ? *Set*(*O*, "length", *F*( $len - actualDeleteCount + itemCount$ ), **true**).
21. Return *A*.

**NOTE 2** The explicit setting of the "length" property of the result Array in step 20 was necessary in previous editions of ECMAScript to ensure that its length was correct in situations where the trailing elements of the result Array were not present. Setting "length" became unnecessary starting in ES2015 when the result Array was initialized to its proper length rather than an empty Array but is carried forward to preserve backward compatibility.

NOTE 3 This method is intentionally generic; it does not require that its **this** value be an Array. Therefore it can be transferred to other kinds of objects for use as a method.

### 23.1.3.32 `Array.prototype.toLocaleString` ( [ *reserved1* [ , *reserved2* ] ] )

An ECMAScript implementation that includes the ECMA-402 Internationalization API must implement this method as specified in the ECMA-402 specification. If an ECMAScript implementation does not include the ECMA-402 API the following specification of this method is used.

NOTE 1 The first edition of ECMA-402 did not include a replacement specification for this method.

The meanings of the optional parameters to this method are defined in the ECMA-402 specification; implementations that do not include ECMA-402 support must not use those parameter positions for anything else.

This method performs the following steps when called:

1. Let *array* be ? `ToObject(this value)`.
2. Let *len* be ? `LengthOfArrayLike(array)`.
3. Let *separator* be the `implementation-defined` list-separator String value appropriate for the `host environment`'s current locale (such as ", ").
4. Let *R* be the empty String.
5. Let *k* be 0.
6. Repeat, while *k* < *len*,
  - a. If *k* > 0, then
    - i. Set *R* to the `string-concatenation` of *R* and *separator*.
  - b. Let *nextElement* be ? `Get(array, ! ToString(ℱ(k)))`.
  - c. If *nextElement* is neither **undefined** nor **null**, then
    - i. Let *S* be ? `ToString(? Invoke(nextElement, "toLocaleString"))`.
    - ii. Set *R* to the `string-concatenation` of *R* and *S*.
  - d. Set *k* to *k* + 1.
7. Return *R*.

NOTE 2 This method converts the elements of the array to Strings using their `toLocaleString` methods, and then concatenates these Strings, separated by occurrences of an `implementation-defined` locale-sensitive separator String. This method is analogous to `toString` except that it is intended to yield a locale-sensitive result corresponding with conventions of the `host environment`'s current locale.

NOTE 3 This method is intentionally generic; it does not require that its **this** value be an Array. Therefore it can be transferred to other kinds of objects for use as a method.

### 23.1.3.33 `Array.prototype.toReversed` ( )

This method performs the following steps when called:

1. Let *O* be ? `ToObject(this value)`.
2. Let *len* be ? `LengthOfArrayLike(O)`.
3. Let *A* be ? `ArrayCreate(len)`.
4. Let *k* be 0.

5. Repeat, while  $k < len$ ,
  - a. Let *from* be ! ToString( $\mathbb{F}(len - k - 1)$ ).
  - b. Let *Pk* be ! ToString( $\mathbb{F}(k)$ ).
  - c. Let *fromValue* be ? Get(*O*, *from*).
  - d. Perform ! CreateDataPropertyOrThrow(*A*, *Pk*, *fromValue*).
  - e. Set *k* to  $k + 1$ .
6. Return *A*.

### 23.1.3.34 Array.prototype.toSorted ( *comparefn* )

This method performs the following steps when called:

1. If *comparefn* is not **undefined** and **IsCallable**(*comparefn*) is **false**, throw a **TypeError** exception.
2. Let *O* be ? **ToObject**(**this** value).
3. Let *len* be ? **LengthOfArrayLike**(*O*).
4. Let *A* be ? **ArrayCreate**(*len*).
5. Let *SortCompare* be a new **Abstract Closure** with parameters (*x*, *y*) that captures *comparefn* and performs the following steps when called:
  - a. Return ? **CompareArrayElements**(*x*, *y*, *comparefn*).
6. Let *sortedList* be ? **SortIndexedProperties**(*O*, *len*, *SortCompare*, read-through-holes).
7. Let *j* be 0.
8. Repeat, while  $j < len$ ,
  - a. Perform ! **CreateDataPropertyOrThrow**(*A*, ! ToString( $\mathbb{F}(j)$ ), *sortedList*[*j*]).
  - b. Set *j* to  $j + 1$ .
9. Return *A*.

### 23.1.3.35 Array.prototype.toSpliced ( *start*, *skipCount*, ...*items* )

This method performs the following steps when called:

1. Let *O* be ? **ToObject**(**this** value).
2. Let *len* be ? **LengthOfArrayLike**(*O*).
3. Let *relativeStart* be ? **ToIntegerOrInfinity**(*start*).
4. If *relativeStart* is  $-\infty$ , let *actualStart* be 0.
5. Else if *relativeStart*  $< 0$ , let *actualStart* be  $\max(len + relativeStart, 0)$ .
6. Else, let *actualStart* be  $\min(relativeStart, len)$ .
7. Let *insertCount* be the number of elements in *items*.
8. If *start* is not present, then
  - a. Let *actualSkipCount* be 0.
9. Else if *skipCount* is not present, then
  - a. Let *actualSkipCount* be  $len - actualStart$ .
10. Else,
  - a. Let *sc* be ? **ToIntegerOrInfinity**(*skipCount*).
  - b. Let *actualSkipCount* be the result of **clamping** *sc* between 0 and  $len - actualStart$ .
11. Let *newLen* be  $len + insertCount - actualSkipCount$ .
12. If *newLen*  $> 2^{53} - 1$ , throw a **TypeError** exception.
13. Let *A* be ? **ArrayCreate**(*newLen*).
14. Let *i* be 0.
15. Let *r* be  $actualStart + actualSkipCount$ .
16. Repeat, while  $i < actualStart$ ,
  - a. Let *Pi* be ! ToString( $\mathbb{F}(i)$ ).

- b. Let *iValue* be ? *Get*(*O*, *Pi*).
  - c. Perform ! *CreateDataPropertyOrThrow*(*A*, *Pi*, *iValue*).
  - d. Set *i* to *i* + 1.
17. For each element *E* of *items*, do
- a. Let *Pi* be ! *ToString*(*F*(*i*)).
  - b. Perform ! *CreateDataPropertyOrThrow*(*A*, *Pi*, *E*).
  - c. Set *i* to *i* + 1.
18. Repeat, while *i* < *newLen*,
- a. Let *Pi* be ! *ToString*(*F*(*i*)).
  - b. Let *from* be ! *ToString*(*F*(*r*)).
  - c. Let *fromValue* be ? *Get*(*O*, *from*).
  - d. Perform ! *CreateDataPropertyOrThrow*(*A*, *Pi*, *fromValue*).
  - e. Set *i* to *i* + 1.
  - f. Set *r* to *r* + 1.
19. Return *A*.

### 23.1.3.36 Array.prototype.toString ( )

This method performs the following steps when called:

1. Let *array* be ? *ToObject*(**this** value).
2. Let *func* be ? *Get*(*array*, "join").
3. If *IsCallable*(*func*) is **false**, set *func* to the intrinsic function %Object.prototype.toString%.
4. Return ? *Call*(*func*, *array*).

**NOTE** This method is intentionally generic; it does not require that its **this** value be an Array. Therefore it can be transferred to other kinds of objects for use as a method.

### 23.1.3.37 Array.prototype.unshift ( ...*items* )

This method prepends the arguments to the start of the array, such that their order within the array is the same as the order in which they appear in the argument list.

It performs the following steps when called:

1. Let *O* be ? *ToObject*(**this** value).
2. Let *len* be ? *LengthOfArrayLike*(*O*).
3. Let *argCount* be the number of elements in *items*.
4. If *argCount* > 0, then
  - a. If *len* + *argCount* > 2<sup>53</sup> - 1, throw a **TypeError** exception.
  - b. Let *k* be *len*.
  - c. Repeat, while *k* > 0,
    - i. Let *from* be ! *ToString*(*F*(*k* - 1)).
    - ii. Let *to* be ! *ToString*(*F*(*k* + *argCount* - 1)).
    - iii. Let *fromPresent* be ? *HasProperty*(*O*, *from*).
    - iv. If *fromPresent* is **true**, then
      1. Let *fromValue* be ? *Get*(*O*, *from*).
      2. Perform ? *Set*(*O*, *to*, *fromValue*, **true**).
    - v. Else,
      1. **Assert**: *fromPresent* is **false**.
      2. Perform ? *DeletePropertyOrThrow*(*O*, *to*).

- vi. Set  $k$  to  $k - 1$ .
- d. Let  $j$  be  $+0$ .
- e. For each element  $E$  of  $items$ , do
  - i. Perform ? `Set(O, ! ToString(j), E, true)`.
  - ii. Set  $j$  to  $j + 1$ .
- 5. Perform ? `Set(O, "length", F(len + argCount), true)`.
- 6. Return  $F(len + argCount)$ .

The "length" property of this method is 1.

**NOTE** This method is intentionally generic; it does not require that its **this** value be an Array. Therefore it can be transferred to other kinds of objects for use as a method.

### 23.1.3.38 Array.prototype.values ( )

This method performs the following steps when called:

1. Let  $O$  be ? `ToObject(this value)`.
2. Return `CreateArrayIterator(O, value)`.

### 23.1.3.39 Array.prototype.with ( *index*, *value* )

This method performs the following steps when called:

1. Let  $O$  be ? `ToObject(this value)`.
2. Let  $len$  be ? `LengthOfArrayLike(O)`.
3. Let  $relativeIndex$  be ? `ToIntegerOrInfinity(index)`.
4. If  $relativeIndex \geq 0$ , let  $actualIndex$  be  $relativeIndex$ .
5. Else, let  $actualIndex$  be  $len + relativeIndex$ .
6. If  $actualIndex \geq len$  or  $actualIndex < 0$ , throw a **RangeError** exception.
7. Let  $A$  be ? `ArrayCreate(len)`.
8. Let  $k$  be 0.
9. Repeat, while  $k < len$ ,
  - a. Let  $Pk$  be ! `ToString(F(k))`.
  - b. If  $k$  is  $actualIndex$ , let  $fromValue$  be  $value$ .
  - c. Else, let  $fromValue$  be ? `Get(O, Pk)`.
  - d. Perform ! `CreateDataPropertyOrThrow(A, Pk, fromValue)`.
  - e. Set  $k$  to  $k + 1$ .
10. Return  $A$ .

### 23.1.3.40 Array.prototype [ @@iterator ] ( )

The initial value of the @@iterator property is %Array.prototype.values%, defined in 23.1.3.38.

### 23.1.3.41 Array.prototype [ @@unscopables ]

The initial value of the @@unscopables data property is an object created by the following steps:

1. Let  $unscopableList$  be `OrdinaryObjectCreate(null)`.
2. Perform ! `CreateDataPropertyOrThrow(unscopableList, "at", true)`.

3. Perform ! `CreateDataPropertyOrThrow(unscopableList, "copyWithin", true)`.
4. Perform ! `CreateDataPropertyOrThrow(unscopableList, "entries", true)`.
5. Perform ! `CreateDataPropertyOrThrow(unscopableList, "fill", true)`.
6. Perform ! `CreateDataPropertyOrThrow(unscopableList, "find", true)`.
7. Perform ! `CreateDataPropertyOrThrow(unscopableList, "findIndex", true)`.
8. Perform ! `CreateDataPropertyOrThrow(unscopableList, "findLast", true)`.
9. Perform ! `CreateDataPropertyOrThrow(unscopableList, "findLastIndex", true)`.
10. Perform ! `CreateDataPropertyOrThrow(unscopableList, "flat", true)`.
11. Perform ! `CreateDataPropertyOrThrow(unscopableList, "flatMap", true)`.
12. Perform ! `CreateDataPropertyOrThrow(unscopableList, "includes", true)`.
13. Perform ! `CreateDataPropertyOrThrow(unscopableList, "keys", true)`.
14. Perform ! `CreateDataPropertyOrThrow(unscopableList, "toReversed", true)`.
15. Perform ! `CreateDataPropertyOrThrow(unscopableList, "toSorted", true)`.
16. Perform ! `CreateDataPropertyOrThrow(unscopableList, "toSpliced", true)`.
17. Perform ! `CreateDataPropertyOrThrow(unscopableList, "values", true)`.
18. Return *unscopableList*.

This property has the attributes { `[[Writable]]: false`, `[[Enumerable]]: false`, `[[Configurable]]: true` }.

**NOTE** The own property names of this object are property names that were not included as standard properties of `Array.prototype` prior to the ECMAScript 2015 specification. These names are ignored for `with` statement binding purposes in order to preserve the behaviour of existing code that might use one of these names as a binding in an outer scope that is shadowed by a `with` statement whose binding object is an Array.

The reason that `"with"` is not included in the *unscopableList* is because it is already a reserved word.

### 23.1.4 Properties of Array Instances

Array instances are *Array exotic objects* and have the internal methods specified for such objects. Array instances inherit properties from the *Array prototype object*.

Array instances have a `"length"` property, and a set of enumerable properties with *array index* names.

#### 23.1.4.1 length

The `"length"` property of an Array instance is a *data property* whose value is always numerically greater than the name of every configurable own property whose name is an *array index*.

The `"length"` property initially has the attributes { `[[Writable]]: true`, `[[Enumerable]]: false`, `[[Configurable]]: false` }.

**NOTE** Reducing the value of the `"length"` property has the side-effect of deleting own array elements whose *array index* is between the old and new length values. However, non-configurable properties can not be deleted. Attempting to set the `"length"` property of an Array to a value that is numerically less than or equal to the largest numeric own *property name* of an existing non-configurable *array-indexed* property of the array will result in the length being set to a numeric value that is one greater than that non-configurable numeric own *property name*. See 10.4.2.1.

## 23.1.5 Array Iterator Objects

An Array Iterator is an object, that represents a specific iteration over some specific Array instance object. There is not a named `constructor` for Array Iterator objects. Instead, Array iterator objects are created by calling certain methods of Array instance objects.

### 23.1.5.1 CreateArrayIterator ( *array*, *kind* )

The abstract operation CreateArrayIterator takes arguments *array* (an Object) and *kind* (key+value, key, or value) and returns a Generator. It is used to create iterator objects for Array methods that return such iterators. It performs the following steps when called:

1. Let *closure* be a new **Abstract Closure** with no parameters that captures *kind* and *array* and performs the following steps when called:
  - a. Let *index* be 0.
  - b. Repeat,
    - i. If *array* has a `[[TypedArrayName]]` internal slot, then
      1. If `IsDetachedBuffer(array.[[ViewedArrayBuffer]])` is **true**, throw a **TypeError** exception.
      2. Let *len* be `array.[[ArrayLength]]`.
    - ii. Else,
      1. Let *len* be `? LengthOfArrayLike(array)`.
    - iii. If *index*  $\geq$  *len*, return `NormalCompletion(undefined)`.
    - iv. If *kind* is key, perform `? GeneratorYield(CreateIterResultObject( $\mathbb{F}$ (index), false))`.
    - v. Else,
      1. Let *elementKey* be `! ToString( $\mathbb{F}$ (index))`.
      2. Let *elementValue* be `? Get(array, elementKey)`.
      3. If *kind* is value, perform `? GeneratorYield(CreateIterResultObject(elementValue, false))`.
      4. Else,
        - a. **Assert**: *kind* is key+value.
        - b. Let *result* be `CreateArrayFromList( $\langle \mathbb{F}$ (index), elementValue  $\rangle$ )`.
        - c. Perform `? GeneratorYield(CreateIterResultObject(result, false))`.
    - vi. Set *index* to *index* + 1.
  2. Return `CreateIterFromClosure(closure, "%ArrayIteratorPrototype%", %ArrayIteratorPrototype%)`.

### 23.1.5.2 The %ArrayIteratorPrototype% Object

The `%ArrayIteratorPrototype%` object:

- has properties that are inherited by all Array Iterator Objects.
- is an **ordinary object**.
- has a `[[Prototype]]` internal slot whose value is `%IteratorPrototype%`.
- has the following properties:

#### 23.1.5.2.1 %ArrayIteratorPrototype%.next ( )

1. Return `? GeneratorResume(this value, empty, "%ArrayIteratorPrototype%")`.



### 23.1.5.2.2 %ArrayIteratorPrototype% [ @@toStringTag ]

The initial value of the @@toStringTag property is the String value "Array Iterator".

This property has the attributes { [[Writable]]: false, [[Enumerable]]: false, [[Configurable]]: true }.

## 23.2 TypedArray Objects

A *TypedArray* presents an array-like view of an underlying binary data buffer (25.1). A *TypedArray element type* is the underlying binary scalar data type that all elements of a *TypedArray* instance have. There is a distinct *TypedArray constructor*, listed in Table 68, for each of the supported element types. Each *constructor* in Table 68 has a corresponding distinct prototype object.

Table 68: The TypedArray Constructors

Constructor Name and Intrinsic	Element Type	Element Size	Conversion Operation	Description
Int8Array %Int8Array%	Int8	1	ToInt8	8-bit two's complement signed integer
Uint8Array %Uint8Array%	Uint8	1	ToUint8	8-bit unsigned integer
Uint8ClampedArray %Uint8ClampedArray%	Uint8C	1	ToUint8Clamp	8-bit unsigned integer (clamped conversion)
Int16Array %Int16Array%	Int16	2	ToInt16	16-bit two's complement signed integer
Uint16Array %Uint16Array%	Uint16	2	ToUint16	16-bit unsigned integer
Int32Array %Int32Array%	Int32	4	ToInt32	32-bit two's complement signed integer
Uint32Array %Uint32Array%	Uint32	4	ToUint32	32-bit unsigned integer
BigInt64Array %BigInt64Array%	BigInt64	8	ToBigInt64	64-bit two's complement signed integer
BigUint64Array %BigUint64Array%	BigUint64	8	ToBigUint64	64-bit unsigned integer
Float32Array %Float32Array%	Float32	4		32-bit IEEE floating point
Float64Array %Float64Array%	Float64	8		64-bit IEEE floating point

In the definitions below, references to *TypedArray* should be replaced with the appropriate *constructor* name from the above table.

### 23.2.1 The %TypedArray% Intrinsic Object

The %TypedArray% intrinsic object:

- is a *constructor function object* that all of the *TypedArray constructor* objects inherit from.

- along with its corresponding prototype object, provides common properties that are inherited by all *TypedArray constructors* and their instances.
- does not have a global name or appear as a property of the *global object*.
- acts as the abstract superclass of the various *TypedArray constructors*.
- will throw an error when invoked, because it is an abstract class *constructor*. The *TypedArray constructors* do not perform a **super** call to it.

### 23.2.1.1 %TypedArray% ( )

This function performs the following steps when called:

1. Throw a **TypeError** exception.

The **"length"** property of this function is **+0**<sub>F</sub>.

### 23.2.2 Properties of the %TypedArray% Intrinsic Object

The *%TypedArray%* intrinsic object:

- has a *[[Prototype]]* internal slot whose value is *%Function.prototype%*.
- has a **"name"** property whose value is **"TypedArray"**.
- has the following properties:

#### 23.2.2.1 %TypedArray%.from ( *source* [ , *mapfn* [ , *thisArg* ] ] )

This method performs the following steps when called:

1. Let *C* be the **this** value.
2. If *IsConstructor*(*C*) is **false**, throw a **TypeError** exception.
3. If *mapfn* is **undefined**, let *mapping* be **false**.
4. Else,
  - a. If *IsCallable*(*mapfn*) is **false**, throw a **TypeError** exception.
  - b. Let *mapping* be **true**.
5. Let *usingIterator* be ? *GetMethod*(*source*, @@iterator).
6. If *usingIterator* is not **undefined**, then
  - a. Let *values* be ? *IteratorToList*(? *GetIteratorFromMethod*(*source*, *usingIterator*)).
  - b. Let *len* be the number of elements in *values*.
  - c. Let *targetObj* be ? *TypedArrayCreate*(*C*, « *F*(*len*) »).
  - d. Let *k* be 0.
  - e. Repeat, while *k* < *len*,
    - i. Let *Pk* be ! *Tostring*(*F*(*k*)).
    - ii. Let *kValue* be the first element of *values*.
    - iii. Remove the first element from *values*.
    - iv. If *mapping* is **true**, then
      1. Let *mappedValue* be ? *Call*(*mapfn*, *thisArg*, « *kValue*, *F*(*k*) »).
    - v. Else, let *mappedValue* be *kValue*.
    - vi. Perform ? *Set*(*targetObj*, *Pk*, *mappedValue*, **true**).
    - vii. Set *k* to *k* + 1.
  - f. **Assert**: *values* is now an empty *List*.
  - g. Return *targetObj*.
7. NOTE: *source* is not an *Iterable* so assume it is already an *array-like object*.
8. Let *arrayLike* be ! *ToObject*(*source*).
9. Let *len* be ? *LengthOfArrayLike*(*arrayLike*).

10. Let *targetObj* be ? `TypedArrayCreate(C, «  $\mathbb{F}(len)$  »)`.
11. Let *k* be 0.
12. Repeat, while *k* < *len*,
  - a. Let *Pk* be ! `Tostring( $\mathbb{F}(k)$ )`.
  - b. Let *kValue* be ? `Get(arrayLike, Pk)`.
  - c. If *mapping* is **true**, then
    - i. Let *mappedValue* be ? `Call(mapfn, thisArg, « kValue,  $\mathbb{F}(k)$  »)`.
  - d. Else, let *mappedValue* be *kValue*.
  - e. Perform ? `Set(targetObj, Pk, mappedValue, true)`.
  - f. Set *k* to *k* + 1.
13. Return *targetObj*.

### 23.2.2.2 %TypedArray%.of ( ...items )

This method performs the following steps when called:

1. Let *len* be the number of elements in *items*.
2. Let *C* be the **this** value.
3. If `IsConstructor(C)` is **false**, throw a **TypeError** exception.
4. Let *newObj* be ? `TypedArrayCreate(C, «  $\mathbb{F}(len)$  »)`.
5. Let *k* be 0.
6. Repeat, while *k* < *len*,
  - a. Let *kValue* be *items*[ *k* ].
  - b. Let *Pk* be ! `Tostring( $\mathbb{F}(k)$ )`.
  - c. Perform ? `Set(newObj, Pk, kValue, true)`.
  - d. Set *k* to *k* + 1.
7. Return *newObj*.

### 23.2.2.3 %TypedArray%.prototype

The initial value of `%TypedArray%.prototype` is the `%TypedArray% prototype` object.

This property has the attributes { `[[Writable]]: false`, `[[Enumerable]]: false`, `[[Configurable]]: false` }.

### 23.2.2.4 get %TypedArray% [ @@species ]

`%TypedArray%[@@species]` is an `accessor property` whose set accessor function is **undefined**. Its get accessor function performs the following steps when called:

1. Return the **this** value.

The value of the **"name"** property of this function is **"get [Symbol.species]"**.

**NOTE** `%TypedArray.prototype%` methods normally use their **this** value's `constructor` to create a derived object. However, a subclass `constructor` may over-ride that default behaviour by redefining its `@@species` property.

## 23.2.3 Properties of the %TypedArray% Prototype Object

The `%TypedArray% prototype object`:

- has a `[[Prototype]]` internal slot whose value is `%Object.prototype%`.
- is `%TypedArray.prototype%`.
- is an [ordinary object](#).
- does not have a `[[ViewedArrayBuffer]]` or any other of the internal slots that are specific to `TypedArray` instance objects.

### 23.2.3.1 `%TypedArray%.prototype.at ( index )`

1. Let *O* be the **this** value.
2. Perform ? `ValidateTypedArray(O)`.
3. Let *len* be `O.[[ArrayLength]]`.
4. Let *relativeIndex* be ? `ToIntegerOrInfinity(index)`.
5. If *relativeIndex*  $\geq 0$ , then
  - a. Let *k* be *relativeIndex*.
6. Else,
  - a. Let *k* be *len* + *relativeIndex*.
7. If *k*  $< 0$  or *k*  $\geq len$ , return **undefined**.
8. Return ! `Get(O, ! ToString(ℱ(k)))`.

### 23.2.3.2 `get %TypedArray%.prototype.buffer`

`%TypedArray%.prototype.buffer` is an [accessor property](#) whose set accessor function is **undefined**. Its get accessor function performs the following steps when called:

1. Let *O* be the **this** value.
2. Perform ? `RequireInternalSlot(O, [[TypedArrayName]])`.
3. **Assert**: *O* has a `[[ViewedArrayBuffer]]` internal slot.
4. Let *buffer* be `O.[[ViewedArrayBuffer]]`.
5. Return *buffer*.

### 23.2.3.3 `get %TypedArray%.prototype.byteLength`

`%TypedArray%.prototype.byteLength` is an [accessor property](#) whose set accessor function is **undefined**. Its get accessor function performs the following steps when called:

1. Let *O* be the **this** value.
2. Perform ? `RequireInternalSlot(O, [[TypedArrayName]])`.
3. **Assert**: *O* has a `[[ViewedArrayBuffer]]` internal slot.
4. Let *buffer* be `O.[[ViewedArrayBuffer]]`.
5. If `IsDetachedBuffer(buffer)` is **true**, return **+0**<sub>ℱ</sub>.
6. Let *size* be `O.[[ByteLength]]`.
7. Return `ℱ(size)`.

### 23.2.3.4 `get %TypedArray%.prototype.byteOffset`

`%TypedArray%.prototype.byteOffset` is an [accessor property](#) whose set accessor function is **undefined**. Its get accessor function performs the following steps when called:

1. Let *O* be the **this** value.
2. Perform ? `RequireInternalSlot(O, [[TypedArrayName]])`.
3. **Assert**: *O* has a `[[ViewedArrayBuffer]]` internal slot.
4. Let *buffer* be `O.[[ViewedArrayBuffer]]`.

5. If `IsDetachedBuffer(buffer)` is **true**, return **+0**<sub>F</sub>.
6. Let `offset` be `O.[[ByteOffset]]`.
7. Return  $\mathbb{F}(offset)$ .

### 23.2.3.5 %TypedArray%.prototype.constructor

The initial value of `%TypedArray%.prototype.constructor` is `%TypedArray%`.

### 23.2.3.6 %TypedArray%.prototype.copyWithin ( *target*, *start* [ , *end* ] )

The interpretation and use of the arguments of this method are the same as for `Array.prototype.copyWithin` as defined in 23.1.3.4.

This method performs the following steps when called:

1. Let `O` be the **this** value.
2. Perform ? `ValidateTypedArray(O)`.
3. Let `len` be `O.[[ArrayLength]]`.
4. Let `relativeTarget` be ? `ToIntegerOrInfinity(target)`.
5. If `relativeTarget = -∞`, let `to` be 0.
6. Else if `relativeTarget < 0`, let `to` be `max(len + relativeTarget, 0)`.
7. Else, let `to` be `min(relativeTarget, len)`.
8. Let `relativeStart` be ? `ToIntegerOrInfinity(start)`.
9. If `relativeStart = -∞`, let `from` be 0.
10. Else if `relativeStart < 0`, let `from` be `max(len + relativeStart, 0)`.
11. Else, let `from` be `min(relativeStart, len)`.
12. If `end` is **undefined**, let `relativeEnd` be `len`; else let `relativeEnd` be ? `ToIntegerOrInfinity(end)`.
13. If `relativeEnd = -∞`, let `final` be 0.
14. Else if `relativeEnd < 0`, let `final` be `max(len + relativeEnd, 0)`.
15. Else, let `final` be `min(relativeEnd, len)`.
16. Let `count` be `min(final - from, len - to)`.
17. If `count > 0`, then
  - a. NOTE: The copying must be performed in a manner that preserves the bit-level encoding of the source data.
  - b. Let `buffer` be `O.[[ViewedArrayBuffer]]`.
  - c. If `IsDetachedBuffer(buffer)` is **true**, throw a **TypeError** exception.
  - d. Let `elementSize` be `TypedArrayElementSize(O)`.
  - e. Let `byteOffset` be `O.[[ByteOffset]]`.
  - f. Let `toByteIndex` be `to × elementSize + byteOffset`.
  - g. Let `fromByteIndex` be `from × elementSize + byteOffset`.
  - h. Let `countBytes` be `count × elementSize`.
  - i. If `fromByteIndex < toByteIndex` and `toByteIndex < fromByteIndex + countBytes`, then
    - i. Let `direction` be -1.
    - ii. Set `fromByteIndex` to `fromByteIndex + countBytes - 1`.
    - iii. Set `toByteIndex` to `toByteIndex + countBytes - 1`.
  - j. Else,
    - i. Let `direction` be 1.
  - k. Repeat, while `countBytes > 0`,
    - i. Let `value` be `GetValueFromBuffer(buffer, fromByteIndex, Uint8, true, Unordered)`.
    - ii. Perform `SetValueInBuffer(buffer, toByteIndex, Uint8, value, true, Unordered)`.
    - iii. Set `fromByteIndex` to `fromByteIndex + direction`.

- iv. Set *toByteIndex* to *toByteIndex* + *direction*.
  - v. Set *countBytes* to *countBytes* - 1.
18. Return *O*.

### 23.2.3.7 %TypedArray%.prototype.entries ( )

This method performs the following steps when called:

1. Let *O* be the **this** value.
2. Perform ? *ValidateTypedArray*(*O*).
3. Return *CreateArrayIterator*(*O*, key+value).

### 23.2.3.8 %TypedArray%.prototype.every ( *callbackfn* [ , *thisArg* ] )

The interpretation and use of the arguments of this method are the same as for *Array.prototype.every* as defined in 23.1.3.6.

This method performs the following steps when called:

1. Let *O* be the **this** value.
2. Perform ? *ValidateTypedArray*(*O*).
3. Let *len* be *O*.[[*ArrayLength*]].
4. If *IsCallable*(*callbackfn*) is **false**, throw a **TypeError** exception.
5. Let *k* be 0.
6. Repeat, while *k* < *len*,
  - a. Let *Pk* be ! *ToString*(*ℱ*(*k*)).
  - b. Let *kValue* be ! *Get*(*O*, *Pk*).
  - c. Let *testResult* be *ToBoolean*(? *Call*(*callbackfn*, *thisArg*, « *kValue*, *ℱ*(*k*), *O* »)).
  - d. If *testResult* is **false**, return **false**.
  - e. Set *k* to *k* + 1.
7. Return **true**.

This method is not generic. The **this** value must be an object with a [[*TypedArrayName*]] internal slot.

### 23.2.3.9 %TypedArray%.prototype.fill ( *value* [ , *start* [ , *end* ] ] )

The interpretation and use of the arguments of this method are the same as for *Array.prototype.fill* as defined in 23.1.3.7.

This method performs the following steps when called:

1. Let *O* be the **this** value.
2. Perform ? *ValidateTypedArray*(*O*).
3. Let *len* be *O*.[[*ArrayLength*]].
4. If *O*.[[*ContentType*]] is *BigInt*, set *value* to ? *ToBigInt*(*value*).
5. Otherwise, set *value* to ? *ToNumber*(*value*).
6. Let *relativeStart* be ? *ToIntegerOrInfinity*(*start*).
7. If *relativeStart* =  $-\infty$ , let *k* be 0.
8. Else if *relativeStart* < 0, let *k* be *max*(*len* + *relativeStart*, 0).
9. Else, let *k* be *min*(*relativeStart*, *len*).
10. If *end* is **undefined**, let *relativeEnd* be *len*; else let *relativeEnd* be ? *ToIntegerOrInfinity*(*end*).
11. If *relativeEnd* =  $-\infty$ , let *final* be 0.

12. Else if *relativeEnd* < 0, let *final* be  $\max(\textit{len} + \textit{relativeEnd}, 0)$ .
13. Else, let *final* be  $\min(\textit{relativeEnd}, \textit{len})$ .
14. If `IsDetachedBuffer(O.[ViewedArrayBuffer])` is **true**, throw a **TypeError** exception.
15. Repeat, while *k* < *final*,
  - a. Let *Pk* be ! `Tostring(F(k))`.
  - b. Perform ! `Set(O, Pk, value, true)`.
  - c. Set *k* to *k* + 1.
16. Return *O*.

### 23.2.3.10 %TypedArray%.prototype.filter ( *callbackfn* [ , *thisArg* ] )

The interpretation and use of the arguments of this method are the same as for `Array.prototype.filter` as defined in 23.1.3.8.

This method performs the following steps when called:

1. Let *O* be the **this** value.
2. Perform ? `ValidateTypedArray(O)`.
3. Let *len* be *O*.[ArrayLength].
4. If `IsCallable(callbackfn)` is **false**, throw a **TypeError** exception.
5. Let *kept* be a new empty `List`.
6. Let *captured* be 0.
7. Let *k* be 0.
8. Repeat, while *k* < *len*,
  - a. Let *Pk* be ! `Tostring(F(k))`.
  - b. Let *kValue* be ! `Get(O, Pk)`.
  - c. Let *selected* be `ToBoolean(? Call(callbackfn, thisArg, « kValue, F(k), O »))`.
  - d. If *selected* is **true**, then
    - i. Append *kValue* to *kept*.
    - ii. Set *captured* to *captured* + 1.
  - e. Set *k* to *k* + 1.
9. Let *A* be ? `TypedArraySpeciesCreate(O, « F(captured) »)`.
10. Let *n* be 0.
11. For each element *e* of *kept*, do
  - a. Perform ! `Set(A, ! ToString(F(n)), e, true)`.
  - b. Set *n* to *n* + 1.
12. Return *A*.

This method is not generic. The **this** value must be an object with a `[[TypedArrayName]]` internal slot.

### 23.2.3.11 %TypedArray%.prototype.find ( *predicate* [ , *thisArg* ] )

The interpretation and use of the arguments of this method are the same as for `Array.prototype.find` as defined in 23.1.3.9.

This method performs the following steps when called:

1. Let *O* be the **this** value.
2. Perform ? `ValidateTypedArray(O)`.
3. Let *len* be *O*.[ArrayLength].
4. Let *findRec* be ? `FindViaPredicate(O, len, ascending, predicate, thisArg)`.
5. Return *findRec*.[Value].

This method is not generic. The **this** value must be an object with a `[[TypedArrayName]]` internal slot.

### 23.2.3.12 `%TypedArray%.prototype.findIndex ( predicate [ , thisArg ] )`

The interpretation and use of the arguments of this method are the same as for `Array.prototype.findIndex` as defined in 23.1.3.10.

This method performs the following steps when called:

1. Let *O* be the **this** value.
2. Perform ? `ValidateTypedArray(O)`.
3. Let *len* be *O*.[`[[ArrayLength]]`].
4. Let *findRec* be ? `FindViaPredicate(O, len, ascending, predicate, thisArg)`.
5. Return *findRec*.[`[[Index]]`].

This method is not generic. The **this** value must be an object with a `[[TypedArrayName]]` internal slot.

### 23.2.3.13 `%TypedArray%.prototype.findLast ( predicate [ , thisArg ] )`

The interpretation and use of the arguments of this method are the same as for `Array.prototype.findLast` as defined in 23.1.3.11.

This method performs the following steps when called:

1. Let *O* be the **this** value.
2. Perform ? `ValidateTypedArray(O)`.
3. Let *len* be *O*.[`[[ArrayLength]]`].
4. Let *findRec* be ? `FindViaPredicate(O, len, descending, predicate, thisArg)`.
5. Return *findRec*.[`[[Value]]`].

This method is not generic. The **this** value must be an object with a `[[TypedArrayName]]` internal slot.

### 23.2.3.14 `%TypedArray%.prototype.findLastIndex ( predicate [ , thisArg ] )`

The interpretation and use of the arguments of this method are the same as for `Array.prototype.findLastIndex` as defined in 23.1.3.12.

This method performs the following steps when called:

1. Let *O* be the **this** value.
2. Perform ? `ValidateTypedArray(O)`.
3. Let *len* be *O*.[`[[ArrayLength]]`].
4. Let *findRec* be ? `FindViaPredicate(O, len, descending, predicate, thisArg)`.
5. Return *findRec*.[`[[Index]]`].

This method is not generic. The **this** value must be an object with a `[[TypedArrayName]]` internal slot.

### 23.2.3.15 `%TypedArray%.prototype.forEach ( callbackfn [ , thisArg ] )`

The interpretation and use of the arguments of this method are the same as for `Array.prototype.forEach` as defined in 23.1.3.15.

This method performs the following steps when called:



1. Let *O* be the **this** value.
2. Perform ? *ValidateTypedArray*(*O*).
3. Let *len* be *O*.[[*ArrayLength*]].
4. If *IsCallable*(*callbackfn*) is **false**, throw a **TypeError** exception.
5. Let *k* be 0.
6. Repeat, while *k* < *len*,
  - a. Let *Pk* be ! *ToString*(*F*(*k*)).
  - b. Let *kValue* be ! *Get*(*O*, *Pk*).
  - c. Perform ? *Call*(*callbackfn*, *thisArg*, « *kValue*, *F*(*k*), *O* »).
  - d. Set *k* to *k* + 1.
7. Return **undefined**.

This method is not generic. The **this** value must be an object with a [[*TypedArrayName*]] internal slot.

### 23.2.3.16 %*TypedArray*%.prototype.includes ( *searchElement* [ , *fromIndex* ] )

The interpretation and use of the arguments of this method are the same as for *Array.prototype.includes* as defined in 23.1.3.16.

This method performs the following steps when called:

1. Let *O* be the **this** value.
2. Perform ? *ValidateTypedArray*(*O*).
3. Let *len* be *O*.[[*ArrayLength*]].
4. If *len* = 0, return **false**.
5. Let *n* be ? *ToIntegerOrInfinity*(*fromIndex*).
6. **Assert**: If *fromIndex* is **undefined**, then *n* is 0.
7. If *n* =  $+\infty$ , return **false**.
8. Else if *n* =  $-\infty$ , set *n* to 0.
9. If *n* ≥ 0, then
  - a. Let *k* be *n*.
10. Else,
  - a. Let *k* be *len* + *n*.
  - b. If *k* < 0, set *k* to 0.
11. Repeat, while *k* < *len*,
  - a. Let *elementK* be ! *Get*(*O*, ! *ToString*(*F*(*k*))).
  - b. If *SameValueZero*(*searchElement*, *elementK*) is **true**, return **true**.
  - c. Set *k* to *k* + 1.
12. Return **false**.

This method is not generic. The **this** value must be an object with a [[*TypedArrayName*]] internal slot.

### 23.2.3.17 %*TypedArray*%.prototype.indexOf ( *searchElement* [ , *fromIndex* ] )

The interpretation and use of the arguments of this method are the same as for *Array.prototype.indexOf* as defined in 23.1.3.17.

This method performs the following steps when called:

1. Let *O* be the **this** value.
2. Perform ? *ValidateTypedArray*(*O*).
3. Let *len* be *O*.[[*ArrayLength*]].

4. If  $len = 0$ , return  $-1_{\mathbb{F}}$ .
5. Let  $n$  be ? `ToIntegerOrInfinity`( $fromIndex$ ).
6. **Assert**: If  $fromIndex$  is **undefined**, then  $n$  is 0.
7. If  $n = +\infty$ , return  $-1_{\mathbb{F}}$ .
8. Else if  $n = -\infty$ , set  $n$  to 0.
9. If  $n \geq 0$ , then
  - a. Let  $k$  be  $n$ .
10. Else,
  - a. Let  $k$  be  $len + n$ .
  - b. If  $k < 0$ , set  $k$  to 0.
11. Repeat, while  $k < len$ ,
  - a. Let  $kPresent$  be ! `HasProperty`( $O$ , ! `ToString`( $\mathbb{F}(k)$ )).
  - b. If  $kPresent$  is **true**, then
    - i. Let  $elementK$  be ! `Get`( $O$ , ! `ToString`( $\mathbb{F}(k)$ )).
    - ii. If `IsStrictlyEqual`( $searchElement$ ,  $elementK$ ) is **true**, return  $\mathbb{F}(k)$ .
  - c. Set  $k$  to  $k + 1$ .
12. Return  $-1_{\mathbb{F}}$ .

This method is not generic. The **this** value must be an object with a `[[TypedArrayName]]` internal slot.

### 23.2.3.18 %TypedArray%.prototype.join ( *separator* )

The interpretation and use of the arguments of this method are the same as for `Array.prototype.join` as defined in 23.1.3.18.

This method performs the following steps when called:

1. Let  $O$  be the **this** value.
2. Perform ? `ValidateTypedArray`( $O$ ).
3. Let  $len$  be  $O$ .[`ArrayLength`].
4. If *separator* is **undefined**, let *sep* be `"`,`"`.
5. Else, let *sep* be ? `ToString`(*separator*).
6. Let  $R$  be the empty String.
7. Let  $k$  be 0.
8. Repeat, while  $k < len$ ,
  - a. If  $k > 0$ , set  $R$  to the **string-concatenation** of  $R$  and *sep*.
  - b. Let  $element$  be ! `Get`( $O$ , ! `ToString`( $\mathbb{F}(k)$ )).
  - c. If  $element$  is **undefined**, let  $next$  be the empty String; otherwise, let  $next$  be ! `ToString`( $element$ ).
  - d. Set  $R$  to the **string-concatenation** of  $R$  and  $next$ .
  - e. Set  $k$  to  $k + 1$ .
9. Return  $R$ .

This method is not generic. The **this** value must be an object with a `[[TypedArrayName]]` internal slot.

### 23.2.3.19 %TypedArray%.prototype.keys ( )

This method performs the following steps when called:

1. Let  $O$  be the **this** value.
2. Perform ? `ValidateTypedArray`( $O$ ).
3. Return `CreateArrayIterator`( $O$ , `key`).

### 23.2.3.20 %TypedArray%.prototype.lastIndexOf ( *searchElement* [ , *fromIndex* ] )

The interpretation and use of the arguments of this method are the same as for `Array.prototype.lastIndexOf` as defined in 23.1.3.20.

This method performs the following steps when called:

1. Let *O* be the **this** value.
2. Perform ? `ValidateTypedArray(O)`.
3. Let *len* be *O*.[[`ArrayLength`]].
4. If *len* = 0, return `-1`<sub>F</sub>.
5. If *fromIndex* is present, let *n* be ? `ToIntegerOrInfinity(fromIndex)`; else let *n* be *len* - 1.
6. If *n* =  $-\infty$ , return `-1`<sub>F</sub>.
7. If *n* ≥ 0, then
  - a. Let *k* be `min(n, len - 1)`.
8. Else,
  - a. Let *k* be `len + n`.
9. Repeat, while *k* ≥ 0,
  - a. Let *kPresent* be ! `HasProperty(O, ! ToString(ℱ(k)))`.
  - b. If *kPresent* is **true**, then
    - i. Let *elementK* be ! `Get(O, ! ToString(ℱ(k)))`.
    - ii. If `IsStrictlyEqual(searchElement, elementK)` is **true**, return `ℱ(k)`.
  - c. Set *k* to *k* - 1.
10. Return `-1`<sub>F</sub>.

This method is not generic. The **this** value must be an object with a [[`TypedArrayName`]] internal slot.

### 23.2.3.21 get %TypedArray%.prototype.length

`%TypedArray%.prototype.length` is an **accessor property** whose set accessor function is **undefined**. Its get accessor function performs the following steps when called:

1. Let *O* be the **this** value.
2. Perform ? `RequireInternalSlot(O, [[TypedArrayName]])`.
3. **Assert**: *O* has [[`ViewedArrayBuffer`]] and [[`ArrayLength`]] internal slots.
4. Let *buffer* be *O*.[[`ViewedArrayBuffer`]].
5. If `IsDetachedBuffer(buffer)` is **true**, return `+0`<sub>F</sub>.
6. Let *length* be *O*.[[`ArrayLength`]].
7. Return `ℱ(length)`.

This function is not generic. The **this** value must be an object with a [[`TypedArrayName`]] internal slot.

### 23.2.3.22 %TypedArray%.prototype.map ( *callbackfn* [ , *thisArg* ] )

The interpretation and use of the arguments of this method are the same as for `Array.prototype.map` as defined in 23.1.3.21.

This method performs the following steps when called:

1. Let *O* be the **this** value.
2. Perform ? `ValidateTypedArray(O)`.

3. Let *len* be *O*.[[ArrayLength]].
4. If `IsCallable(callbackfn)` is **false**, throw a **TypeError** exception.
5. Let *A* be ? `TypedArraySpeciesCreate(O, « F(len) »)`.
6. Let *k* be 0.
7. Repeat, while *k* < *len*,
  - a. Let *Pk* be ! `Tostring(F(k))`.
  - b. Let *kValue* be ! `Get(O, Pk)`.
  - c. Let *mappedValue* be ? `Call(callbackfn, thisArg, « kValue, F(k), O »)`.
  - d. Perform ? `Set(A, Pk, mappedValue, true)`.
  - e. Set *k* to *k* + 1.
8. Return *A*.

This method is not generic. The **this** value must be an object with a [[TypedArrayName]] internal slot.

### 23.2.3.23 %TypedArray%.prototype.reduce ( *callbackfn* [ , *initialValue* ] )

The interpretation and use of the arguments of this method are the same as for `Array.prototype.reduce` as defined in 23.1.3.24.

This method performs the following steps when called:

1. Let *O* be the **this** value.
2. Perform ? `ValidateTypedArray(O)`.
3. Let *len* be *O*.[[ArrayLength]].
4. If `IsCallable(callbackfn)` is **false**, throw a **TypeError** exception.
5. If *len* = 0 and *initialValue* is not present, throw a **TypeError** exception.
6. Let *k* be 0.
7. Let *accumulator* be **undefined**.
8. If *initialValue* is present, then
  - a. Set *accumulator* to *initialValue*.
9. Else,
  - a. Let *Pk* be ! `Tostring(F(k))`.
  - b. Set *accumulator* to ! `Get(O, Pk)`.
  - c. Set *k* to *k* + 1.
10. Repeat, while *k* < *len*,
  - a. Let *Pk* be ! `Tostring(F(k))`.
  - b. Let *kValue* be ! `Get(O, Pk)`.
  - c. Set *accumulator* to ? `Call(callbackfn, undefined, « accumulator, kValue, F(k), O »)`.
  - d. Set *k* to *k* + 1.
11. Return *accumulator*.

This method is not generic. The **this** value must be an object with a [[TypedArrayName]] internal slot.

### 23.2.3.24 %TypedArray%.prototype.reduceRight ( *callbackfn* [ , *initialValue* ] )

The interpretation and use of the arguments of this method are the same as for `Array.prototype.reduceRight` as defined in 23.1.3.25.

This method performs the following steps when called:

1. Let *O* be the **this** value.
2. Perform ? `ValidateTypedArray(O)`.
3. Let *len* be *O*.[[ArrayLength]].

4. If `IsCallable(callbackfn)` is **false**, throw a **TypeError** exception.
5. If `len = 0` and `initialValue` is not present, throw a **TypeError** exception.
6. Let `k` be `len - 1`.
7. Let `accumulator` be **undefined**.
8. If `initialValue` is present, then
  - a. Set `accumulator` to `initialValue`.
9. Else,
  - a. Let `Pk` be ! `ToString(F(k))`.
  - b. Set `accumulator` to ! `Get(O, Pk)`.
  - c. Set `k` to `k - 1`.
10. Repeat, while `k ≥ 0`,
  - a. Let `Pk` be ! `ToString(F(k))`.
  - b. Let `kValue` be ! `Get(O, Pk)`.
  - c. Set `accumulator` to ? `Call(callbackfn, undefined, « accumulator, kValue, F(k), O »)`.
  - d. Set `k` to `k - 1`.
11. Return `accumulator`.

This method is not generic. The **this** value must be an object with a `[[TypedArrayName]]` internal slot.

### 23.2.3.25 %TypedArray%.prototype.reverse ( )

The interpretation and use of the arguments of this method are the same as for `Array.prototype.reverse` as defined in 23.1.3.26.

This method performs the following steps when called:

1. Let `O` be the **this** value.
2. Perform ? `ValidateTypedArray(O)`.
3. Let `len` be `O.[[ArrayLength]]`.
4. Let `middle` be `floor(len / 2)`.
5. Let `lower` be 0.
6. Repeat, while `lower ≠ middle`,
  - a. Let `upper` be `len - lower - 1`.
  - b. Let `upperP` be ! `ToString(F(upper))`.
  - c. Let `lowerP` be ! `ToString(F(lower))`.
  - d. Let `lowerValue` be ! `Get(O, lowerP)`.
  - e. Let `upperValue` be ! `Get(O, upperP)`.
  - f. Perform ! `Set(O, lowerP, upperValue, true)`.
  - g. Perform ! `Set(O, upperP, lowerValue, true)`.
  - h. Set `lower` to `lower + 1`.
7. Return `O`.

This method is not generic. The **this** value must be an object with a `[[TypedArrayName]]` internal slot.

### 23.2.3.26 %TypedArray%.prototype.set ( source [ , offset ] )

This method sets multiple values in this `TypedArray`, reading the values from `source`. The details differ based upon the type of `source`. The optional `offset` value indicates the first element index in this `TypedArray` where values are written. If omitted, it is assumed to be 0.

It performs the following steps when called:

1. Let `target` be the **this** value.

2. Perform ? [RequireInternalSlot](#)(*target*, [[TypedArrayName]]).
3. **Assert**: *target* has a [[ViewedArrayBuffer]] internal slot.
4. Let *targetOffset* be ? [ToIntegerOrInfinity](#)(*offset*).
5. If *targetOffset* < 0, throw a **RangeError** exception.
6. If *source* is an Object that has a [[TypedArrayName]] internal slot, then
  - a. Perform ? [SetTypedArrayFromTypedArray](#)(*target*, *targetOffset*, *source*).
7. Else,
  - a. Perform ? [SetTypedArrayFromArrayLike](#)(*target*, *targetOffset*, *source*).
8. Return **undefined**.

This method is not generic. The **this** value must be an object with a [[TypedArrayName]] internal slot.

### 23.2.3.26.1 SetTypedArrayFromTypedArray ( *target*, *targetOffset*, *source* )

The abstract operation [SetTypedArrayFromTypedArray](#) takes arguments *target* (a TypedArray), *targetOffset* (a non-negative integer or  $+\infty$ ), and *source* (a TypedArray) and returns either a [normal completion containing](#) unused or a [throw completion](#). It sets multiple values in *target*, starting at index *targetOffset*, reading the values from *source*. It performs the following steps when called:

1. Let *targetBuffer* be *target*.[[ViewedArrayBuffer]].
2. If [IsDetachedBuffer](#)(*targetBuffer*) is **true**, throw a **TypeError** exception.
3. Let *targetLength* be *target*.[[ArrayLength]].
4. Let *srcBuffer* be *source*.[[ViewedArrayBuffer]].
5. If [IsDetachedBuffer](#)(*srcBuffer*) is **true**, throw a **TypeError** exception.
6. Let *targetType* be [TypedArrayElementType](#)(*target*).
7. Let *targetElementSize* be [TypedArrayElementSize](#)(*target*).
8. Let *targetByteOffset* be *target*.[[ByteOffset]].
9. Let *srcType* be [TypedArrayElementType](#)(*source*).
10. Let *srcElementSize* be [TypedArrayElementSize](#)(*source*).
11. Let *srcLength* be *source*.[[ArrayLength]].
12. Let *srcByteOffset* be *source*.[[ByteOffset]].
13. If *targetOffset* =  $+\infty$ , throw a **RangeError** exception.
14. If *srcLength* + *targetOffset* > *targetLength*, throw a **RangeError** exception.
15. If *target*.[[ContentType]] is not *source*.[[ContentType]], throw a **TypeError** exception.
16. If [IsSharedArrayBuffer](#)(*srcBuffer*) is **true**, [IsSharedArrayBuffer](#)(*targetBuffer*) is **true**, and *srcBuffer*.[[ArrayBufferData]] is *targetBuffer*.[[ArrayBufferData]], let *sameSharedArrayBuffer* be **true**; otherwise, let *sameSharedArrayBuffer* be **false**.
17. If [SameValue](#)(*srcBuffer*, *targetBuffer*) is **true** or *sameSharedArrayBuffer* is **true**, then
  - a. Let *srcByteLength* be *source*.[[ByteLength]].
  - b. Set *srcBuffer* to ? [CloneArrayBuffer](#)(*srcBuffer*, *srcByteOffset*, *srcByteLength*).
  - c. Let *srcByteIndex* be 0.
18. Else, let *srcByteIndex* be *srcByteOffset*.
19. Let *targetByteIndex* be *targetOffset* × *targetElementSize* + *targetByteOffset*.
20. Let *limit* be *targetByteIndex* + *targetElementSize* × *srcLength*.
21. If *srcType* is *targetType*, then
  - a. NOTE: The transfer must be performed in a manner that preserves the bit-level encoding of the source data.
  - b. Repeat, while *targetByteIndex* < *limit*,
    - i. Let *value* be [GetValueFromBuffer](#)(*srcBuffer*, *srcByteIndex*, Uint8, **true**, Unordered).
    - ii. Perform [SetValueInBuffer](#)(*targetBuffer*, *targetByteIndex*, Uint8, *value*, **true**, Unordered).
    - iii. Set *srcByteIndex* to *srcByteIndex* + 1.
    - iv. Set *targetByteIndex* to *targetByteIndex* + 1.

22. Else,
  - a. Repeat, while *targetByteIndex* < *limit*,
    - i. Let *value* be *GetValueFromBuffer*(*srcBuffer*, *srcByteIndex*, *srcType*, **true**, Unordered).
    - ii. Perform *SetValueInBuffer*(*targetBuffer*, *targetByteIndex*, *targetType*, *value*, **true**, Unordered).
    - iii. Set *srcByteIndex* to *srcByteIndex* + *srcElementSize*.
    - iv. Set *targetByteIndex* to *targetByteIndex* + *targetElementSize*.
23. Return unused.

### 23.2.3.26.2 SetTypedArrayFromArrayLike ( *target*, *targetOffset*, *source* )

The abstract operation *SetTypedArrayFromArrayLike* takes arguments *target* (a TypedArray), *targetOffset* (a non-negative integer or  $+\infty$ ), and *source* (an ECMAScript language value, but not a TypedArray) and returns either a normal completion containing unused or a throw completion. It sets multiple values in *target*, starting at index *targetOffset*, reading the values from *source*. It performs the following steps when called:

1. Let *targetBuffer* be *target*.[[ViewedArrayBuffer]].
2. If *IsDetachedBuffer*(*targetBuffer*) is **true**, throw a **TypeError** exception.
3. Let *targetLength* be *target*.[[ArrayLength]].
4. Let *src* be ? *ToObject*(*source*).
5. Let *srcLength* be ? *LengthOfArrayLike*(*src*).
6. If *targetOffset* =  $+\infty$ , throw a **RangeError** exception.
7. If *srcLength* + *targetOffset* > *targetLength*, throw a **RangeError** exception.
8. Let *k* be 0.
9. Repeat, while *k* < *srcLength*,
  - a. Let *Pk* be ! *ToString*( $\mathbb{F}(k)$ ).
  - b. Let *value* be ? *Get*(*src*, *Pk*).
  - c. Let *targetIndex* be  $\mathbb{F}(\text{targetOffset} + k)$ .
  - d. Perform ? *IntegerIndexedElementSet*(*target*, *targetIndex*, *value*).
  - e. Set *k* to *k* + 1.
10. Return unused.

### 23.2.3.27 %TypedArray%.prototype.slice ( *start*, *end* )

The interpretation and use of the arguments of this method are the same as for *Array.prototype.slice* as defined in 23.1.3.28.

This method performs the following steps when called:

1. Let *O* be the **this** value.
2. Perform ? *ValidateTypedArray*(*O*).
3. Let *len* be *O*.[[ArrayLength]].
4. Let *relativeStart* be ? *ToIntegerOrInfinity*(*start*).
5. If *relativeStart* =  $-\infty$ , let *k* be 0.
6. Else if *relativeStart* < 0, let *k* be  $\max(\text{len} + \text{relativeStart}, 0)$ .
7. Else, let *k* be  $\min(\text{relativeStart}, \text{len})$ .
8. If *end* is **undefined**, let *relativeEnd* be *len*; else let *relativeEnd* be ? *ToIntegerOrInfinity*(*end*).
9. If *relativeEnd* =  $-\infty$ , let *final* be 0.
10. Else if *relativeEnd* < 0, let *final* be  $\max(\text{len} + \text{relativeEnd}, 0)$ .
11. Else, let *final* be  $\min(\text{relativeEnd}, \text{len})$ .
12. Let *count* be  $\max(\text{final} - k, 0)$ .
13. Let *A* be ? *TypedArraySpeciesCreate*(*O*, «  $\mathbb{F}(\text{count})$  »).

14. If *count* > 0, then
  - a. If `IsDetachedBuffer(O.[[ViewedArrayBuffer]])` is **true**, throw a **TypeError** exception.
  - b. Let *srcType* be `TypedArrayElementType(O)`.
  - c. Let *targetType* be `TypedArrayElementType(A)`.
  - d. If *srcType* is *targetType*, then
    - i. NOTE: The transfer must be performed in a manner that preserves the bit-level encoding of the source data.
    - ii. Let *srcBuffer* be `O.[[ViewedArrayBuffer]]`.
    - iii. Let *targetBuffer* be `A.[[ViewedArrayBuffer]]`.
    - iv. Let *elementSize* be `TypedArrayElementSize(O)`.
    - v. Let *srcByteOffset* be `O.[[ByteOffset]]`.
    - vi. Let *srcByteIndex* be  $(k \times \textit{elementSize}) + \textit{srcByteOffset}$ .
    - vii. Let *targetByteIndex* be `A.[[ByteOffset]]`.
    - viii. Let *limit* be  $\textit{targetByteIndex} + \textit{count} \times \textit{elementSize}$ .
    - ix. Repeat, while *targetByteIndex* < *limit*,
      1. Let *value* be `GetValueFromBuffer(srcBuffer, srcByteIndex, Uint8, true, Unordered)`.
      2. Perform `SetValueInBuffer(targetBuffer, targetByteIndex, Uint8, value, true, Unordered)`.
      3. Set *srcByteIndex* to *srcByteIndex* + 1.
      4. Set *targetByteIndex* to *targetByteIndex* + 1.
  - e. Else,
    - i. Let *n* be 0.
    - ii. Repeat, while *k* < *final*,
      1. Let *Pk* be `! ToString(ℱ(k))`.
      2. Let *kValue* be `! Get(O, Pk)`.
      3. Perform `! Set(A, ! ToString(ℱ(n)), kValue, true)`.
      4. Set *k* to *k* + 1.
      5. Set *n* to *n* + 1.
15. Return *A*.

This method is not generic. The **this** value must be an object with a `[[TypedArrayName]]` internal slot.

### 23.2.3.28 %TypedArray%.prototype.some ( *callbackfn* [ , *thisArg* ] )

The interpretation and use of the arguments of this method are the same as for `Array.prototype.some` as defined in 23.1.3.29.

This method performs the following steps when called:

1. Let *O* be the **this** value.
2. Perform `? ValidateTypedArray(O)`.
3. Let *len* be `O.[[ArrayLength]]`.
4. If `IsCallable(callbackfn)` is **false**, throw a **TypeError** exception.
5. Let *k* be 0.
6. Repeat, while *k* < *len*,
  - a. Let *Pk* be `! ToString(ℱ(k))`.
  - b. Let *kValue* be `! Get(O, Pk)`.
  - c. Let *testResult* be `ToBoolean(? Call(callbackfn, thisArg, « kValue, ℱ(k), O »))`.
  - d. If *testResult* is **true**, return **true**.
  - e. Set *k* to *k* + 1.
7. Return **false**.



This method is not generic. The **this** value must be an object with a `[[TypedArrayName]]` internal slot.

### 23.2.3.29 `%TypedArray%.prototype.sort ( comparefn )`

This is a distinct method that, except as described below, implements the same requirements as those of `Array.prototype.sort` as defined in 23.1.3.30. The implementation of this method may be optimized with the knowledge that the **this** value is an object that has a fixed length and whose `integer-indexed` properties are not sparse.

This method is not generic. The **this** value must be an object with a `[[TypedArrayName]]` internal slot.

It performs the following steps when called:

1. If *comparefn* is not **undefined** and `IsCallable(comparefn)` is **false**, throw a **TypeError** exception.
2. Let *obj* be the **this** value.
3. Perform ? `ValidateTypedArray(obj)`.
4. Let *len* be `obj.[[ArrayLength]]`.
5. NOTE: The following closure performs a numeric comparison rather than the string comparison used in 23.1.3.30.
6. Let *SortCompare* be a new **Abstract Closure** with parameters (*x*, *y*) that captures *comparefn* and performs the following steps when called:
  - a. Return ? `CompareTypedArrayElements(x, y, comparefn)`.
7. Let *sortedList* be ? `SortIndexedProperties(obj, len, SortCompare, read-through-holes)`.
8. Let *j* be 0.
9. Repeat, while *j* < *len*,
  - a. Perform ! `Set(obj, ! ToString(F(j)), sortedList[j], true)`.
  - b. Set *j* to *j* + 1.
10. Return *obj*.

**NOTE** Because **NaN** always compares greater than any other value (see `CompareTypedArrayElements`), **NaN** property values always sort to the end of the result when *comparefn* is not provided.

### 23.2.3.30 `%TypedArray%.prototype.subarray ( begin, end )`

This method returns a new `TypedArray` whose element type is the element type of this `TypedArray` and whose `ArrayBuffer` is the `ArrayBuffer` of this `TypedArray`, referencing the elements in the `interval` from *begin* (inclusive) to *end* (exclusive). If either *begin* or *end* is negative, it refers to an index from the end of the array, as opposed to from the beginning.

It performs the following steps when called:

1. Let *O* be the **this** value.
2. Perform ? `RequireInternalSlot(O, [[TypedArrayName]])`.
3. **Assert**: *O* has a `[[ViewedArrayBuffer]]` internal slot.
4. Let *buffer* be `O.[[ViewedArrayBuffer]]`.
5. Let *srcLength* be `O.[[ArrayLength]]`.
6. Let *relativeBegin* be ? `ToIntegerOrInfinity(begin)`.
7. If *relativeBegin* =  $-\infty$ , let *beginIndex* be 0.
8. Else if *relativeBegin* < 0, let *beginIndex* be `max(srcLength + relativeBegin, 0)`.
9. Else, let *beginIndex* be `min(relativeBegin, srcLength)`.
10. If *end* is **undefined**, let *relativeEnd* be *srcLength*; else let *relativeEnd* be ? `ToIntegerOrInfinity(end)`.

11. If *relativeEnd* =  $-\infty$ , let *endIndex* be 0.
12. Else if *relativeEnd* < 0, let *endIndex* be  $\max(\text{srcLength} + \text{relativeEnd}, 0)$ .
13. Else, let *endIndex* be  $\min(\text{relativeEnd}, \text{srcLength})$ .
14. Let *newLength* be  $\max(\text{endIndex} - \text{beginIndex}, 0)$ .
15. Let *elementSize* be `TypedArrayElementSize(O)`.
16. Let *srcByteOffset* be `O.[[ByteOffset]]`.
17. Let *beginByteOffset* be  $\text{srcByteOffset} + \text{beginIndex} \times \text{elementSize}$ .
18. Let *argumentsList* be « *buffer*,  $\mathbb{F}(\text{beginByteOffset})$ ,  $\mathbb{F}(\text{newLength})$  ».
19. Return ? `TypedArraySpeciesCreate(O, argumentsList)`.

This method is not generic. The **this** value must be an object with a `[[TypedArrayName]]` internal slot.

### 23.2.3.31 %TypedArray%.prototype.toLocaleString ( [ *reserved1* [ , *reserved2* ] ] )

This is a distinct method that implements the same algorithm as `Array.prototype.toLocaleString` as defined in 23.1.3.32 except that the **this** value's `[[ArrayLength]]` internal slot is accessed in place of performing a `[[Get]]` of "length". The implementation of the algorithm may be optimized with the knowledge that the **this** value is an object that has a fixed length and whose `integer-indexed` properties are not sparse. However, such optimization must not introduce any observable changes in the specified behaviour of the algorithm.

This method is not generic. `ValidateTypedArray` is applied to the **this** value prior to evaluating the algorithm. If its result is an `abrupt completion` that exception is thrown instead of evaluating the algorithm.

**NOTE** If the ECMAScript implementation includes the ECMA-402 Internationalization API this method is based upon the algorithm for `Array.prototype.toLocaleString` that is in the ECMA-402 specification.

### 23.2.3.32 %TypedArray%.prototype.toReversed ( )

This method performs the following steps when called:

1. Let *O* be the **this** value.
2. Perform ? `ValidateTypedArray(O)`.
3. Let *length* be `O.[[ArrayLength]]`.
4. Let *A* be ? `TypedArrayCreateSameType(O, «  $\mathbb{F}(\text{length})$  »)`.
5. Let *k* be 0.
6. Repeat, while *k* < *length*,
  - a. Let *from* be ! `ToString( $\mathbb{F}(\text{length} - k - 1)$ )`.
  - b. Let *Pk* be ! `ToString( $\mathbb{F}(k)$ )`.
  - c. Let *fromValue* be ! `Get(O, from)`.
  - d. Perform ! `Set(A, Pk, fromValue, true)`.
  - e. Set *k* to *k* + 1.
7. Return *A*.

### 23.2.3.33 %TypedArray%.prototype.toSorted ( *comparefn* )

This method performs the following steps when called:

1. If *comparefn* is not **undefined** and `IsCallable(comparefn)` is **false**, throw a **TypeError** exception.
2. Let *O* be the **this** value.
3. Perform ? `ValidateTypedArray(O)`.

4. Let *len* be *O*.[[ArrayLength]].
5. Let *A* be ? *TypedArrayCreateSameType*(*O*, « *F*(*len*) »).
6. NOTE: The following closure performs a numeric comparison rather than the string comparison used in 23.1.3.34.
7. Let *SortCompare* be a new *Abstract Closure* with parameters (*x*, *y*) that captures *comparefn* and performs the following steps when called:
  - a. Return ? *CompareTypedArrayElements*(*x*, *y*, *comparefn*).
8. Let *sortedList* be ? *SortIndexedProperties*(*O*, *len*, *SortCompare*, read-through-holes).
9. Let *j* be 0.
10. Repeat, while *j* < *len*,
  - a. Perform ! *Set*(*A*, ! *ToString*(*F*(*j*)), *sortedList*[*j*], **true**).
  - b. Set *j* to *j* + 1.
11. Return *A*.

### 23.2.3.34 %TypedArray%.prototype.toString ( )

The initial value of the "toString" property is %Array.prototype.toString%, defined in 23.1.3.36.

### 23.2.3.35 %TypedArray%.prototype.values ( )

This method performs the following steps when called:

1. Let *O* be the **this** value.
2. Perform ? *ValidateTypedArray*(*O*).
3. Return *CreateArrayIterator*(*O*, value).

### 23.2.3.36 %TypedArray%.prototype.with ( *index*, *value* )

This method performs the following steps when called:

1. Let *O* be the **this** value.
2. Perform ? *ValidateTypedArray*(*O*).
3. Let *len* be *O*.[[ArrayLength]].
4. Let *relativeIndex* be ? *ToIntegerOrInfinity*(*index*).
5. If *relativeIndex* ≥ 0, let *actualIndex* be *relativeIndex*.
6. Else, let *actualIndex* be *len* + *relativeIndex*.
7. If *O*.[[ContentType]] is BigInt, let *numericValue* be ? *ToBigInt*(*value*).
8. Else, let *numericValue* be ? *ToNumber*(*value*).
9. If *IsValidIntegerIndex*(*O*, *F*(*actualIndex*)) is **false**, throw a **RangeError** exception.
10. Let *A* be ? *TypedArrayCreateSameType*(*O*, « *F*(*len*) »).
11. Let *k* be 0.
12. Repeat, while *k* < *len*,
  - a. Let *Pk* be ! *ToString*(*F*(*k*)).
  - b. If *k* is *actualIndex*, let *fromValue* be *numericValue*.
  - c. Else, let *fromValue* be ! *Get*(*O*, *Pk*).
  - d. Perform ! *Set*(*A*, *Pk*, *fromValue*, **true**).
  - e. Set *k* to *k* + 1.
13. Return *A*.

### 23.2.3.37 %TypedArray%.prototype [ @@iterator ] ( )

The initial value of the @@iterator property is %TypedArray.prototype.values%, defined in 23.2.3.35.

### 23.2.3.38 get %TypedArray%.prototype [ @@toStringTag ]

%TypedArray%.prototype[@@toStringTag] is an [accessor property](#) whose set accessor function is **undefined**. Its get accessor function performs the following steps when called:

1. Let *O* be the **this** value.
2. If *O* is not an [Object](#), return **undefined**.
3. If *O* does not have a [[TypedArrayName]] internal slot, return **undefined**.
4. Let *name* be *O*.[[TypedArrayName]].
5. **Assert**: *name* is a [String](#).
6. Return *name*.

This property has the attributes { [[Enumerable]]: **false**, [[Configurable]]: **true** }.

The initial value of the "name" property of this function is "get [Symbol.toStringTag]".

## 23.2.4 Abstract Operations for TypedArray Objects

### 23.2.4.1 TypedArraySpeciesCreate ( *exemplar*, *argumentList* )

The abstract operation TypedArraySpeciesCreate takes arguments *exemplar* (a TypedArray) and *argumentList* (a [List of ECMAScript language values](#)) and returns either a [normal completion containing](#) a TypedArray or a [throw completion](#). It is used to specify the creation of a new TypedArray using a [constructor](#) function that is derived from *exemplar*. Unlike [ArraySpeciesCreate](#), which can create non-Array objects through the use of @@species, this operation enforces that the [constructor](#) function creates an actual TypedArray. It performs the following steps when called:

1. Let *defaultConstructor* be the intrinsic object associated with the [constructor](#) name *exemplar*. [[TypedArrayName]] in [Table 68](#).
2. Let *constructor* be ? [SpeciesConstructor](#)(*exemplar*, *defaultConstructor*).
3. Let *result* be ? [TypedArrayCreate](#)(*constructor*, *argumentList*).
4. **Assert**: *result* has [[TypedArrayName]] and [[ContentType]] internal slots.
5. If *result*.[[ContentType]] is not *exemplar*.[[ContentType]], throw a **TypeError** exception.
6. Return *result*.

### 23.2.4.2 TypedArrayCreate ( *constructor*, *argumentList* )

The abstract operation TypedArrayCreate takes arguments *constructor* (a [constructor](#)) and *argumentList* (a [List of ECMAScript language values](#)) and returns either a [normal completion containing](#) a TypedArray or a [throw completion](#). It is used to specify the creation of a new TypedArray using a [constructor](#) function. It performs the following steps when called:

1. Let *newTypedArray* be ? [Construct](#)(*constructor*, *argumentList*).
2. Perform ? [ValidateTypedArray](#)(*newTypedArray*).
3. If the number of elements in *argumentList* is 1 and *argumentList*[0] is a [Number](#), then
  - a. If *newTypedArray*.[[ArrayLength]] <  $\mathbb{R}$ (*argumentList*[0]), throw a **TypeError** exception.
4. Return *newTypedArray*.

### 23.2.4.3 TypedArrayCreateSameType ( *exemplar*, *argumentList* )

The abstract operation TypedArrayCreateSameType takes arguments *exemplar* (a TypedArray) and *argumentList* (a List of ECMAScript language values) and returns either a normal completion containing a TypedArray or a throw completion. It is used to specify the creation of a new TypedArray using a constructor function that is derived from *exemplar*. Unlike TypedArraySpeciesCreate, which can construct custom TypedArray subclasses through the use of @@species, this operation always uses one of the built-in TypedArray constructors. It performs the following steps when called:

1. Let *constructor* be the intrinsic object associated with the constructor name *exemplar*.  
[[TypedArrayName]] in Table 68.
2. Let *result* be ? TypedArrayCreate(*constructor*, *argumentList*).
3. Assert: *result* has [[TypedArrayName]] and [[ContentType]] internal slots.
4. Assert: *result*.[[ContentType]] is *exemplar*.[[ContentType]].
5. Return *result*.

### 23.2.4.4 ValidateTypedArray ( *O* )

The abstract operation ValidateTypedArray takes argument *O* (an ECMAScript language value) and returns either a normal completion containing unused or a throw completion. It performs the following steps when called:

1. Perform ? RequireInternalSlot(*O*, [[TypedArrayName]]).
2. Assert: *O* has a [[ViewedArrayBuffer]] internal slot.
3. Let *buffer* be *O*.[[ViewedArrayBuffer]].
4. If IsDetachedBuffer(*buffer*) is true, throw a TypeError exception.
5. Return unused.

### 23.2.4.5 TypedArrayElementSize ( *O* )

The abstract operation TypedArrayElementSize takes argument *O* (a TypedArray) and returns a non-negative integer. It performs the following steps when called:

1. Return the Element Size value specified in Table 68 for *O*.[[TypedArrayName]].

### 23.2.4.6 TypedArrayElementType ( *O* )

The abstract operation TypedArrayElementType takes argument *O* (a TypedArray) and returns a TypedArray element type. It performs the following steps when called:

1. Return the Element Type value specified in Table 68 for *O*.[[TypedArrayName]].

### 23.2.4.7 CompareTypedArrayElements ( *x*, *y*, *comparefn* )

The abstract operation CompareTypedArrayElements takes arguments *x* (a Number or a BigInt), *y* (a Number or a BigInt), and *comparefn* (a function object or undefined) and returns either a normal completion containing a Number or an abrupt completion. It performs the following steps when called:

1. Assert: *x* is a Number and *y* is a Number, or *x* is a BigInt and *y* is a BigInt.
2. If *comparefn* is not undefined, then
  - a. Let *v* be ? ToNumber(? Call(*comparefn*, undefined, « *x*, *y* »)).
  - b. If *v* is NaN, return +0<sub>F</sub>.

- c. Return *v*.
3. If *x* and *y* are both **NaN**, return **+0<sub>F</sub>**.
4. If *x* is **NaN**, return **1<sub>F</sub>**.
5. If *y* is **NaN**, return **-1<sub>F</sub>**.
6. If *x* < *y*, return **-1<sub>F</sub>**.
7. If *x* > *y*, return **1<sub>F</sub>**.
8. If *x* is **-0<sub>F</sub>** and *y* is **+0<sub>F</sub>**, return **-1<sub>F</sub>**.
9. If *x* is **+0<sub>F</sub>** and *y* is **-0<sub>F</sub>**, return **1<sub>F</sub>**.
10. Return **+0<sub>F</sub>**.

**NOTE** This performs a numeric comparison rather than the string comparison used in 23.1.3.30.2.

## 23.2.5 The *TypedArray* Constructors

Each *TypedArray* constructor:

- is an intrinsic object that has the structure described below, differing only in the name used as the *constructor* name instead of *TypedArray*, in Table 68.
- is a function whose behaviour differs based upon the number and types of its arguments. The actual behaviour of a call of *TypedArray* depends upon the number and kind of arguments that are passed to it.
- is not intended to be called as a function and will throw an exception when called in that manner.
- may be used as the value of an **extends** clause of a class definition. Subclass *constructors* that intend to inherit the specified *TypedArray* behaviour must include a **super** call to the *TypedArray* constructor to create and initialize the subclass instance with the internal state necessary to support the *%TypedArray%.prototype* built-in methods.
- has a **"length"** property whose value is **3<sub>F</sub>**.

### 23.2.5.1 *TypedArray* ( ...*args* )

Each *TypedArray* constructor performs the following steps when called:

1. If *NewTarget* is **undefined**, throw a **TypeError** exception.
2. Let *constructorName* be the String value of the *Constructor* Name value specified in Table 68 for this *TypedArray* constructor.
3. Let *proto* be **"%TypedArray.prototype%"**.
4. Let *numberOfArgs* be the number of elements in *args*.
5. If *numberOfArgs* = 0, then
  - a. Return ? *AllocateTypedArray*(*constructorName*, *NewTarget*, *proto*, 0).
6. Else,
  - a. Let *firstArgument* be *args*[0].
  - b. If *firstArgument* is an **Object**, then
    - i. Let *O* be ? *AllocateTypedArray*(*constructorName*, *NewTarget*, *proto*).
    - ii. If *firstArgument* has a **[[TypedArrayName]]** internal slot, then
      1. Perform ? *InitializeTypedArrayFromTypedArray*(*O*, *firstArgument*).
    - iii. Else if *firstArgument* has an **[[ArrayBufferData]]** internal slot, then
      1. If *numberOfArgs* > 1, let *byteOffset* be *args*[1]; else let *byteOffset* be **undefined**.
      2. If *numberOfArgs* > 2, let *length* be *args*[2]; else let *length* be **undefined**.
      3. Perform ? *InitializeTypedArrayFromArrayBuffer*(*O*, *firstArgument*, *byteOffset*, *length*).
    - iv. Else,

1. Assert: *firstArgument* is an Object and *firstArgument* does not have either a `[[TypedArrayName]]` or an `[[ArrayBufferData]]` internal slot.
2. Let *usingIterator* be ? `GetMethod(firstArgument, @@iterator)`.
3. If *usingIterator* is not **undefined**, then
  - a. Let *values* be ? `IteratorToList(? GetIteratorFromMethod(firstArgument, usingIterator))`.
  - b. Perform ? `InitializeTypedArrayFromList(O, values)`.
4. Else,
  - a. NOTE: *firstArgument* is not an Iterable so assume it is already an array-like object.
  - b. Perform ? `InitializeTypedArrayFromArrayLike(O, firstArgument)`.
- v. Return *O*.
- c. Else,
  - i. Assert: *firstArgument* is not an Object.
  - ii. Let *elementLength* be ? `ToIndex(firstArgument)`.
  - iii. Return ? `AllocateTypedArray(constructorName, NewTarget, proto, elementLength)`.

#### 23.2.5.1.1 AllocateTypedArray ( *constructorName*, *newTarget*, *defaultProto* [ , *length* ] )

The abstract operation `AllocateTypedArray` takes arguments *constructorName* (a String which is the name of a TypedArray constructor in Table 68), *newTarget* (a constructor), and *defaultProto* (a String) and optional argument *length* (a non-negative integer) and returns either a normal completion containing a TypedArray or a throw completion. It is used to validate and create an instance of a TypedArray constructor. If the *length* argument is passed, an ArrayBuffer of that length is also allocated and associated with the new TypedArray instance. `AllocateTypedArray` provides common semantics that is used by *TypedArray*. It performs the following steps when called:

1. Let *proto* be ? `GetPrototypeFromConstructor(newTarget, defaultProto)`.
2. Let *obj* be `IntegerIndexedObjectCreate(proto)`.
3. Assert: *obj*.`[[ViewedArrayBuffer]]` is **undefined**.
4. Set *obj*.`[[TypedArrayName]]` to *constructorName*.
5. If *constructorName* is either **"BigInt64Array"** or **"BigUint64Array"**, set *obj*.`[[ContentType]]` to **BigInt**.
6. Otherwise, set *obj*.`[[ContentType]]` to **Number**.
7. If *length* is not present, then
  - a. Set *obj*.`[[ByteLength]]` to 0.
  - b. Set *obj*.`[[ByteOffset]]` to 0.
  - c. Set *obj*.`[[ArrayLength]]` to 0.
8. Else,
  - a. Perform ? `AllocateTypedArrayBuffer(obj, length)`.
9. Return *obj*.

#### 23.2.5.1.2 InitializeTypedArrayFromTypedArray ( *O*, *srcArray* )

The abstract operation `InitializeTypedArrayFromTypedArray` takes arguments *O* (a TypedArray) and *srcArray* (a TypedArray) and returns either a normal completion containing unused or a throw completion. It performs the following steps when called:

1. Let *srcData* be *srcArray*.`[[ViewedArrayBuffer]]`.
2. If `IsDetachedBuffer(srcData)` is **true**, throw a **TypeError** exception.
3. Let *elementType* be `TypedArrayElementType(O)`.
4. Let *elementSize* be `TypedArrayElementSize(O)`.
5. Let *srcType* be `TypedArrayElementType(srcArray)`.
6. Let *srcElementSize* be `TypedArrayElementSize(srcArray)`.

7. Let *srcByteOffset* be *srcArray*.[[ByteOffset]].
8. Let *elementLength* be *srcArray*.[[ArrayLength]].
9. Let *byteLength* be *elementSize* × *elementLength*.
10. If *elementType* is *srcType*, then
  - a. Let *data* be ? **CloneArrayBuffer**(*srcData*, *srcByteOffset*, *byteLength*).
11. Else,
  - a. Let *data* be ? **AllocateArrayBuffer**(%ArrayBuffer%, *byteLength*).
  - b. If *srcArray*.[[ContentType]] is not **O**.[[ContentType]], throw a **TypeError** exception.
  - c. Let *srcByteIndex* be *srcByteOffset*.
  - d. Let *targetByteIndex* be 0.
  - e. Let *count* be *elementLength*.
  - f. Repeat, while *count* > 0,
    - i. Let *value* be **GetValueFromBuffer**(*srcData*, *srcByteIndex*, *srcType*, **true**, Unordered).
    - ii. Perform **SetValueInBuffer**(*data*, *targetByteIndex*, *elementType*, *value*, **true**, Unordered).
    - iii. Set *srcByteIndex* to *srcByteIndex* + *srcElementSize*.
    - iv. Set *targetByteIndex* to *targetByteIndex* + *elementSize*.
    - v. Set *count* to *count* - 1.
12. Set **O**.[[ViewedArrayBuffer]] to *data*.
13. Set **O**.[[ByteLength]] to *byteLength*.
14. Set **O**.[[ByteOffset]] to 0.
15. Set **O**.[[ArrayLength]] to *elementLength*.
16. Return unused.

### 23.2.5.1.3 InitializeTypedArrayFromArrayBuffer ( **O**, *buffer*, *byteOffset*, *length* )

The abstract operation InitializeTypedArrayFromArrayBuffer takes arguments **O** (a TypedArray), *buffer* (an ArrayBuffer or a SharedArrayBuffer), *byteOffset* (an ECMAScript language value), and *length* (an ECMAScript language value) and returns either a normal completion containing unused or a throw completion. It performs the following steps when called:

1. Let *elementSize* be **TypedArrayElementSize**(**O**).
2. Let *offset* be ? **ToIndex**(*byteOffset*).
3. If *offset* modulo *elementSize* ≠ 0, throw a **RangeError** exception.
4. If *length* is not **undefined**, then
  - a. Let *newLength* be ? **ToIndex**(*length*).
5. If **IsDetachedBuffer**(*buffer*) is **true**, throw a **TypeError** exception.
6. Let *bufferByteLength* be *buffer*.[[ArrayBufferByteLength]].
7. If *length* is **undefined**, then
  - a. If *bufferByteLength* modulo *elementSize* ≠ 0, throw a **RangeError** exception.
  - b. Let *newByteLength* be *bufferByteLength* - *offset*.
  - c. If *newByteLength* < 0, throw a **RangeError** exception.
8. Else,
  - a. Let *newByteLength* be *newLength* × *elementSize*.
  - b. If *offset* + *newByteLength* > *bufferByteLength*, throw a **RangeError** exception.
9. Set **O**.[[ViewedArrayBuffer]] to *buffer*.
10. Set **O**.[[ByteLength]] to *newByteLength*.
11. Set **O**.[[ByteOffset]] to *offset*.
12. Set **O**.[[ArrayLength]] to *newByteLength* / *elementSize*.
13. Return unused.



#### 23.2.5.1.4 InitializeTypedArrayFromList ( *O*, *values* )

The abstract operation InitializeTypedArrayFromList takes arguments *O* (a TypedArray) and *values* (a List of ECMAScript language values) and returns either a normal completion containing unused or a throw completion. It performs the following steps when called:

1. Let *len* be the number of elements in *values*.
2. Perform ? AllocateTypedArrayBuffer(*O*, *len*).
3. Let *k* be 0.
4. Repeat, while *k* < *len*,
  - a. Let *Pk* be ! ToString( $\mathbb{F}(k)$ ).
  - b. Let *kValue* be the first element of *values*.
  - c. Remove the first element from *values*.
  - d. Perform ? Set(*O*, *Pk*, *kValue*, true).
  - e. Set *k* to *k* + 1.
5. Assert: *values* is now an empty List.
6. Return unused.

#### 23.2.5.1.5 InitializeTypedArrayFromArrayLike ( *O*, *arrayLike* )

The abstract operation InitializeTypedArrayFromArrayLike takes arguments *O* (a TypedArray) and *arrayLike* (an Object, but not a TypedArray or an ArrayBuffer) and returns either a normal completion containing unused or a throw completion. It performs the following steps when called:

1. Let *len* be ? LengthOfArrayLike(*arrayLike*).
2. Perform ? AllocateTypedArrayBuffer(*O*, *len*).
3. Let *k* be 0.
4. Repeat, while *k* < *len*,
  - a. Let *Pk* be ! ToString( $\mathbb{F}(k)$ ).
  - b. Let *kValue* be ? Get(*arrayLike*, *Pk*).
  - c. Perform ? Set(*O*, *Pk*, *kValue*, true).
  - d. Set *k* to *k* + 1.
5. Return unused.

#### 23.2.5.1.6 AllocateTypedArrayBuffer ( *O*, *length* )

The abstract operation AllocateTypedArrayBuffer takes arguments *O* (a TypedArray) and *length* (a non-negative integer) and returns either a normal completion containing unused or a throw completion. It allocates and associates an ArrayBuffer with *O*. It performs the following steps when called:

1. Assert: *O*.[[ViewedArrayBuffer]] is **undefined**.
2. Let *elementSize* be TypedArrayElementSize(*O*).
3. Let *byteLength* be *elementSize* × *length*.
4. Let *data* be ? AllocateArrayBuffer(%ArrayBuffer%, *byteLength*).
5. Set *O*.[[ViewedArrayBuffer]] to *data*.
6. Set *O*.[[ByteLength]] to *byteLength*.
7. Set *O*.[[ByteOffset]] to 0.
8. Set *O*.[[ArrayLength]] to *length*.
9. Return unused.

## 23.2.6 Properties of the *TypedArray* Constructors

Each *TypedArray* constructor:

- has a `[[Prototype]]` internal slot whose value is `%TypedArray%`.
- has a **"name"** property whose value is the String value of the `constructor` name specified for it in Table 68.
- has the following properties:

### 23.2.6.1 *TypedArray*.BYTES\_PER\_ELEMENT

The value of *TypedArray*.BYTES\_PER\_ELEMENT is the Element Size value specified in Table 68 for *TypedArray*.

This property has the attributes { `[[Writable]]`: **false**, `[[Enumerable]]`: **false**, `[[Configurable]]`: **false** }.

### 23.2.6.2 *TypedArray*.prototype

The initial value of *TypedArray*.prototype is the corresponding *TypedArray* prototype intrinsic object (23.2.7).

This property has the attributes { `[[Writable]]`: **false**, `[[Enumerable]]`: **false**, `[[Configurable]]`: **false** }.

## 23.2.7 Properties of the *TypedArray* Prototype Objects

Each *TypedArray* prototype object:

- has a `[[Prototype]]` internal slot whose value is `%TypedArray.prototype%`.
- is an *ordinary object*.
- does not have a `[[ViewedArrayBuffer]]` or any other of the internal slots that are specific to *TypedArray* instance objects.

### 23.2.7.1 *TypedArray*.prototype.BYTES\_PER\_ELEMENT

The value of *TypedArray*.prototype.BYTES\_PER\_ELEMENT is the Element Size value specified in Table 68 for *TypedArray*.

This property has the attributes { `[[Writable]]`: **false**, `[[Enumerable]]`: **false**, `[[Configurable]]`: **false** }.

### 23.2.7.2 *TypedArray*.prototype.constructor

The initial value of a *TypedArray*.prototype.constructor is the corresponding `%TypedArray%` intrinsic object.

## 23.2.8 Properties of *TypedArray* Instances

*TypedArray* instances are *Integer-Indexed exotic objects*. Each *TypedArray* instance inherits properties from the corresponding *TypedArray* prototype object. Each *TypedArray* instance has the following internal slots: `[[TypedArrayName]]`, `[[ViewedArrayBuffer]]`, `[[ByteLength]]`, `[[ByteOffset]]`, and `[[ArrayLength]]`.

## 24 Keyed Collections

### 24.1 Map Objects

Maps are collections of key/value pairs where both the keys and values may be arbitrary [ECMAScript language values](#). A distinct key value may only occur in one key/value pair within the Map's collection. Distinct key values are discriminated using the [SameValueZero](#) comparison algorithm.

Maps must be implemented using either hash tables or other mechanisms that, on average, provide access times that are sublinear on the number of elements in the collection. The data structure used in this specification is only intended to describe the required observable semantics of Maps. It is not intended to be a viable implementation model.

#### 24.1.1 The Map Constructor

The Map [constructor](#):

- is `%Map%`.
- is the initial value of the `"Map"` property of the [global object](#).
- creates and initializes a new Map when called as a [constructor](#).
- is not intended to be called as a function and will throw an exception when called in that manner.
- may be used as the value in an `extends` clause of a class definition. Subclass [constructors](#) that intend to inherit the specified Map behaviour must include a `super` call to the Map [constructor](#) to create and initialize the subclass instance with the internal state necessary to support the `Map.prototype` built-in methods.

##### 24.1.1.1 Map ( [ *iterable* ] )

This function performs the following steps when called:

1. If `NewTarget` is `undefined`, throw a `TypeError` exception.
2. Let `map` be `? OrdinaryCreateFromConstructor(NewTarget, "%Map.prototype%", « [[MapData]] »)`.
3. Set `map.[[MapData]]` to a new empty [List](#).
4. If `iterable` is either `undefined` or `null`, return `map`.
5. Let `adder` be `? Get(map, "set")`.
6. If `IsCallable(adder)` is `false`, throw a `TypeError` exception.
7. Return `? AddEntriesFromIterable(map, iterable, adder)`.

**NOTE** If the parameter `iterable` is present, it is expected to be an object that implements an `@@iterator` method that returns an iterator object that produces a two element [array-like object](#) whose first element is a value that will be used as a Map key and whose second element is the value to associate with that key.

##### 24.1.1.2 AddEntriesFromIterable ( *target*, *iterable*, *adder* )

The abstract operation `AddEntriesFromIterable` takes arguments `target` (an Object), `iterable` (an [ECMAScript language value](#), but not `undefined` or `null`), and `adder` (a [function object](#)) and returns either a [normal completion](#) containing an [ECMAScript language value](#) or a [throw completion](#). `adder` will be invoked, with `target` as the receiver. It performs the following steps when called:

1. Let `iteratorRecord` be `? GetIterator(iterable, sync)`.
2. Repeat,
  - a. Let `next` be `? IteratorStep(iteratorRecord)`.

- b. If *next* is **false**, return *target*.
- c. Let *nextItem* be ? *IteratorValue*(*next*).
- d. If *nextItem* is not an Object, then
  - i. Let *error* be *ThrowCompletion*(a newly created **TypeError** object).
  - ii. Return ? *IteratorClose*(*iteratorRecord*, *error*).
- e. Let *k* be *Completion*(*Get*(*nextItem*, "0")).
- f. *IfAbruptCloseIterator*(*k*, *iteratorRecord*).
- g. Let *v* be *Completion*(*Get*(*nextItem*, "1")).
- h. *IfAbruptCloseIterator*(*v*, *iteratorRecord*).
- i. Let *status* be *Completion*(*Call*(*adder*, *target*, « *k*, *v* »)).
- j. *IfAbruptCloseIterator*(*status*, *iteratorRecord*).

**NOTE** The parameter *iterable* is expected to be an object that implements an `@@iterator` method that returns an iterator object that produces a two element *array-like object* whose first element is a value that will be used as a Map key and whose second element is the value to associate with that key.

## 24.1.2 Properties of the Map Constructor

The Map *constructor*:

- has a `[[Prototype]]` internal slot whose value is `%Function.prototype%`.
- has the following properties:

### 24.1.2.1 Map.prototype

The initial value of `Map.prototype` is the *Map prototype object*.

This property has the attributes { `[[Writable]]`: **false**, `[[Enumerable]]`: **false**, `[[Configurable]]`: **false** }.

### 24.1.2.2 get Map [ @@species ]

`Map[@@species]` is an *accessor property* whose set accessor function is **undefined**. Its get accessor function performs the following steps when called:

1. Return the **this** value.

The value of the "name" property of this function is **"get [Symbol.species]"**.

**NOTE** Methods that create derived collection objects should call `@@species` to determine the *constructor* to use to create the derived objects. Subclass *constructor* may over-ride `@@species` to change the default *constructor* assignment.

## 24.1.3 Properties of the Map Prototype Object

The *Map prototype object*:

- is `%Map.prototype%`.
- has a `[[Prototype]]` internal slot whose value is `%Object.prototype%`.
- is an *ordinary object*.
- does not have a `[[MapData]]` internal slot.

### 24.1.3.1 Map.prototype.clear ( )

This method performs the following steps when called:

1. Let *M* be the **this** value.
2. Perform ? [RequireInternalSlot](#)(*M*, [[MapData]]).
3. For each [Record](#) { [[Key]], [[Value]] } *p* of *M*.[[MapData]], do
  - a. Set *p*.[[Key]] to empty.
  - b. Set *p*.[[Value]] to empty.
4. Return **undefined**.

**NOTE** The existing [[MapData]] [List](#) is preserved because there may be existing Map Iterator objects that are suspended midway through iterating over that [List](#).

### 24.1.3.2 Map.prototype.constructor

The initial value of `Map.prototype.constructor` is `%Map%`.

### 24.1.3.3 Map.prototype.delete ( *key* )

This method performs the following steps when called:

1. Let *M* be the **this** value.
2. Perform ? [RequireInternalSlot](#)(*M*, [[MapData]]).
3. For each [Record](#) { [[Key]], [[Value]] } *p* of *M*.[[MapData]], do
  - a. If *p*.[[Key]] is not empty and [SameValueZero](#)(*p*.[[Key]], *key*) is **true**, then
    - i. Set *p*.[[Key]] to empty.
    - ii. Set *p*.[[Value]] to empty.
    - iii. Return **true**.
4. Return **false**.

**NOTE** The value empty is used as a specification device to indicate that an entry has been deleted. Actual implementations may take other actions such as physically removing the entry from internal data structures.

### 24.1.3.4 Map.prototype.entries ( )

This method performs the following steps when called:

1. Let *M* be the **this** value.
2. Return ? [CreateMapIterator](#)(*M*, key+value).

### 24.1.3.5 Map.prototype.forEach ( *callbackfn* [ , *thisArg* ] )

This method performs the following steps when called:

1. Let *M* be the **this** value.
2. Perform ? [RequireInternalSlot](#)(*M*, [[MapData]]).
3. If [IsCallable](#)(*callbackfn*) is **false**, throw a **TypeError** exception.

4. Let *entries* be *M*.[[MapData]].
5. Let *numEntries* be the number of elements in *entries*.
6. Let *index* be 0.
7. Repeat, while *index* < *numEntries*,
  - a. Let *e* be *entries*[*index*].
  - b. Set *index* to *index* + 1.
  - c. If *e*.[[Key]] is not empty, then
    - i. Perform ? Call(*callbackfn*, *thisArg*, « *e*.[[Value]], *e*.[[Key]], *M* »).
    - ii. NOTE: The number of elements in *entries* may have increased during execution of *callbackfn*.
    - iii. Set *numEntries* to the number of elements in *entries*.
8. Return **undefined**.

NOTE *callbackfn* should be a function that accepts three arguments. **forEach** calls *callbackfn* once for each key/value pair present in the Map, in key insertion order. *callbackfn* is called only for keys of the Map which actually exist; it is not called for keys that have been deleted from the Map.

If a *thisArg* parameter is provided, it will be used as the **this** value for each invocation of *callbackfn*. If it is not provided, **undefined** is used instead.

*callbackfn* is called with three arguments: the value of the item, the key of the item, and the Map being traversed.

**forEach** does not directly mutate the object on which it is called but the object may be mutated by the calls to *callbackfn*. Each entry of a map's [[MapData]] is only visited once. New keys added after the call to **forEach** begins are visited. A key will be revisited if it is deleted after it has been visited and then re-added before the **forEach** call completes. Keys that are deleted after the call to **forEach** begins and before being visited are not visited unless the key is added again before the **forEach** call completes.

### 24.1.3.6 Map.prototype.get ( *key* )

This method performs the following steps when called:

1. Let *M* be the **this** value.
2. Perform ? RequireInternalSlot(*M*, [[MapData]]).
3. For each Record { [[Key]], [[Value]] } *p* of *M*.[[MapData]], do
  - a. If *p*.[[Key]] is not empty and SameValueZero(*p*.[[Key]], *key*) is **true**, return *p*.[[Value]].
4. Return **undefined**.

### 24.1.3.7 Map.prototype.has ( *key* )

This method performs the following steps when called:

1. Let *M* be the **this** value.
2. Perform ? RequireInternalSlot(*M*, [[MapData]]).
3. For each Record { [[Key]], [[Value]] } *p* of *M*.[[MapData]], do
  - a. If *p*.[[Key]] is not empty and SameValueZero(*p*.[[Key]], *key*) is **true**, return **true**.
4. Return **false**.

### 24.1.3.8 Map.prototype.keys ( )

This method performs the following steps when called:

1. Let *M* be the **this** value.
2. Return ? [CreateMapIterator](#)(*M*, key).

### 24.1.3.9 Map.prototype.set ( *key*, *value* )

This method performs the following steps when called:

1. Let *M* be the **this** value.
2. Perform ? [RequireInternalSlot](#)(*M*, [[MapData]]).
3. For each [Record](#) { [[Key]], [[Value]] } *p* of *M*.[[MapData]], do
  - a. If *p*.[[Key]] is not empty and [SameValueZero](#)(*p*.[[Key]], *key*) is **true**, then
    - i. Set *p*.[[Value]] to *value*.
    - ii. Return *M*.
4. If *key* is  $-0_{\text{F}}$ , set *key* to  $+0_{\text{F}}$ .
5. Let *p* be the [Record](#) { [[Key]]: *key*, [[Value]]: *value* }.
6. Append *p* to *M*.[[MapData]].
7. Return *M*.

### 24.1.3.10 get Map.prototype.size

**Map.prototype.size** is an [accessor property](#) whose set accessor function is **undefined**. Its get accessor function performs the following steps when called:

1. Let *M* be the **this** value.
2. Perform ? [RequireInternalSlot](#)(*M*, [[MapData]]).
3. Let *count* be 0.
4. For each [Record](#) { [[Key]], [[Value]] } *p* of *M*.[[MapData]], do
  - a. If *p*.[[Key]] is not empty, set *count* to *count* + 1.
5. Return  $\mathbb{F}$ (*count*).

### 24.1.3.11 Map.prototype.values ( )

This method performs the following steps when called:

1. Let *M* be the **this** value.
2. Return ? [CreateMapIterator](#)(*M*, value).

### 24.1.3.12 Map.prototype [ @@iterator ] ( )

The initial value of the @@iterator property is %Map.prototype.entries%, defined in 24.1.3.4.

### 24.1.3.13 Map.prototype [ @@toStringTag ]

The initial value of the @@toStringTag property is the String value **"Map"**.

This property has the attributes { [[Writable]]: **false**, [[Enumerable]]: **false**, [[Configurable]]: **true** }.

## 24.1.4 Properties of Map Instances

Map instances are [ordinary objects](#) that inherit properties from the Map prototype. Map instances also have a `[[MapData]]` internal slot.

## 24.1.5 Map Iterator Objects

A Map Iterator is an object, that represents a specific iteration over some specific Map instance object. There is not a named [constructor](#) for Map Iterator objects. Instead, map iterator objects are created by calling certain methods of Map instance objects.

### 24.1.5.1 CreateMapIterator ( *map*, *kind* )

The abstract operation CreateMapIterator takes arguments *map* (an [ECMAScript language value](#)) and *kind* (key+value, key, or value) and returns either a [normal completion containing](#) a Generator or a [throw completion](#). It is used to create iterator objects for Map methods that return such iterators. It performs the following steps when called:

1. Perform ? [RequireInternalSlot](#)(*map*, `[[MapData]]`).
2. Let *closure* be a new [Abstract Closure](#) with no parameters that captures *map* and *kind* and performs the following steps when called:
  - a. Let *entries* be *map*.`[[MapData]]`.
  - b. Let *index* be 0.
  - c. Let *numEntries* be the number of elements in *entries*.
  - d. Repeat, while *index* < *numEntries*,
    - i. Let *e* be *entries*[*index*].
    - ii. Set *index* to *index* + 1.
    - iii. If *e*.`[[Key]]` is not empty, then
      1. If *kind* is key, let *result* be *e*.`[[Key]]`.
      2. Else if *kind* is value, let *result* be *e*.`[[Value]]`.
      3. Else,
        - a. [Assert](#): *kind* is key+value.
        - b. Let *result* be [CreateArrayFromList](#)(« *e*.`[[Key]]`, *e*.`[[Value]]` »).
    4. Perform ? [GeneratorYield](#)([CreateIterResultObject](#)(*result*, **false**)).
    5. NOTE: The number of elements in *entries* may have increased while execution of this abstract operation was paused by [Yield](#).
    6. Set *numEntries* to the number of elements in *entries*.
  - e. Return **undefined**.
3. Return [CreateIteratorFromClosure](#)(*closure*, "%MapIteratorPrototype%", %MapIteratorPrototype%).

### 24.1.5.2 The %MapIteratorPrototype% Object

The `%MapIteratorPrototype%` object:

- has properties that are inherited by all Map Iterator Objects.
- is an [ordinary object](#).
- has a `[[Prototype]]` internal slot whose value is `%IteratorPrototype%`.
- has the following properties:



#### 24.1.5.2.1 %MapIteratorPrototype%.next ( )

1. Return ? [GeneratorResume](#)(this value, empty, "%MapIteratorPrototype%").

#### 24.1.5.2.2 %MapIteratorPrototype% [ @@toStringTag ]

The initial value of the @@toStringTag property is the String value "Map Iterator".

This property has the attributes { [[Writable]]: **false**, [[Enumerable]]: **false**, [[Configurable]]: **true** }.

## 24.2 Set Objects

Set objects are collections of [ECMAScript language values](#). A distinct value may only occur once as an element of a Set's collection. Distinct values are discriminated using the [SameValueZero](#) comparison algorithm.

Set objects must be implemented using either hash tables or other mechanisms that, on average, provide access times that are sublinear on the number of elements in the collection. The data structure used in this specification is only intended to describe the required observable semantics of Set objects. It is not intended to be a viable implementation model.

### 24.2.1 The Set Constructor

The Set [constructor](#):

- is %Set%.
- is the initial value of the "Set" property of the [global object](#).
- creates and initializes a new Set object when called as a [constructor](#).
- is not intended to be called as a function and will throw an exception when called in that manner.
- may be used as the value in an **extends** clause of a class definition. Subclass [constructors](#) that intend to inherit the specified Set behaviour must include a **super** call to the Set [constructor](#) to create and initialize the subclass instance with the internal state necessary to support the **Set.prototype** built-in methods.

#### 24.2.1.1 Set ( [ *iterable* ] )

This function performs the following steps when called:

1. If NewTarget is **undefined**, throw a **TypeError** exception.
2. Let *set* be ? [OrdinaryCreateFromConstructor](#)(NewTarget, "%Set.prototype%", « [[SetData]] »).
3. Set *set*.[[SetData]] to a new empty [List](#).
4. If *iterable* is either **undefined** or **null**, return *set*.
5. Let *adder* be ? [Get](#)(*set*, "add").
6. If [IsCallable](#)(*adder*) is **false**, throw a **TypeError** exception.
7. Let *iteratorRecord* be ? [GetIterator](#)(*iterable*, sync).
8. Repeat,
  - a. Let *next* be ? [IteratorStep](#)(*iteratorRecord*).
  - b. If *next* is **false**, return *set*.
  - c. Let *nextValue* be ? [IteratorValue](#)(*next*).
  - d. Let *status* be [Completion](#)([Call](#)(*adder*, *set*, « *nextValue* »)).
  - e. [IfAbruptCloseIterator](#)(*status*, *iteratorRecord*).

## 24.2.2 Properties of the Set Constructor

The Set [constructor](#):

- has a [\[\[Prototype\]\]](#) internal slot whose value is [%Function.prototype%](#).
- has the following properties:

### 24.2.2.1 Set.prototype

The initial value of [Set.prototype](#) is the [Set prototype object](#).

This property has the attributes { [\[\[Writable\]\]](#): **false**, [\[\[Enumerable\]\]](#): **false**, [\[\[Configurable\]\]](#): **false** }.

### 24.2.2.2 get Set [ @@species ]

[Set\[@@species\]](#) is an [accessor property](#) whose set accessor function is **undefined**. Its get accessor function performs the following steps when called:

1. Return the **this** value.

The value of the **"name"** property of this function is **"get [Symbol.species]"**.

**NOTE** Methods that create derived collection objects should call [@@species](#) to determine the [constructor](#) to use to create the derived objects. Subclass [constructor](#) may over-ride [@@species](#) to change the default [constructor](#) assignment.

## 24.2.3 Properties of the Set Prototype Object

The [Set prototype object](#):

- is [%Set.prototype%](#).
- has a [\[\[Prototype\]\]](#) internal slot whose value is [%Object.prototype%](#).
- is an [ordinary object](#).
- does not have a [\[\[SetData\]\]](#) internal slot.

### 24.2.3.1 Set.prototype.add ( *value* )

This method performs the following steps when called:

1. Let *S* be the **this** value.
2. Perform ? [RequireInternalSlot](#)(*S*, [\[\[SetData\]\]](#)).
3. For each element *e* of *S*.[\[\[SetData\]\]](#), do
  - a. If *e* is not empty and [SameValueZero](#)(*e*, *value*) is **true**, then
    - i. Return *S*.
4. If *value* is  $-0_{\text{F}}$ , set *value* to  $+0_{\text{F}}$ .
5. Append *value* to *S*.[\[\[SetData\]\]](#).
6. Return *S*.

### 24.2.3.2 Set.prototype.clear ( )

This method performs the following steps when called:

1. Let **S** be the **this** value.
2. Perform ? [RequireInternalSlot\(S, \[\[SetData\]\]\)](#).
3. For each element **e** of **S**.[[SetData]], do
  - a. Replace the element of **S**.[[SetData]] whose value is **e** with an element whose value is empty.
4. Return **undefined**.

**NOTE** The existing [[SetData]] [List](#) is preserved because there may be existing Set Iterator objects that are suspended midway through iterating over that [List](#).

### 24.2.3.3 Set.prototype.constructor

The initial value of **Set.prototype.constructor** is [%Set%](#).

### 24.2.3.4 Set.prototype.delete ( *value* )

This method performs the following steps when called:

1. Let **S** be the **this** value.
2. Perform ? [RequireInternalSlot\(S, \[\[SetData\]\]\)](#).
3. For each element **e** of **S**.[[SetData]], do
  - a. If **e** is not empty and [SameValueZero\(e, value\)](#) is **true**, then
    - i. Replace the element of **S**.[[SetData]] whose value is **e** with an element whose value is empty.
    - ii. Return **true**.
4. Return **false**.

**NOTE** The value empty is used as a specification device to indicate that an entry has been deleted. Actual implementations may take other actions such as physically removing the entry from internal data structures.

### 24.2.3.5 Set.prototype.entries ( )

This method performs the following steps when called:

1. Let **S** be the **this** value.
2. Return ? [CreateSetIterator\(S, key+value\)](#).

**NOTE** For iteration purposes, a Set appears similar to a Map where each entry has the same value for its key and value.

### 24.2.3.6 Set.prototype.forEach ( *callbackfn* [ , *thisArg* ] )

This method performs the following steps when called:

1. Let **S** be the **this** value.
2. Perform ? [RequireInternalSlot\(S, \[\[SetData\]\]\)](#).
3. If [IsCallable\(callbackfn\)](#) is **false**, throw a **TypeError** exception.
4. Let **entries** be **S**.[[SetData]].
5. Let **numEntries** be the number of elements in **entries**.

6. Let *index* be 0.
7. Repeat, while *index* < *numEntries*,
  - a. Let *e* be *entries*[*index*].
  - b. Set *index* to *index* + 1.
  - c. If *e* is not empty, then
    - i. Perform ? *Call*(*callbackfn*, *thisArg*, « *e*, *e*, *S* »).
    - ii. NOTE: The number of elements in *entries* may have increased during execution of *callbackfn*.
    - iii. Set *numEntries* to the number of elements in *entries*.
8. Return **undefined**.

**NOTE** *callbackfn* should be a function that accepts three arguments. **forEach** calls *callbackfn* once for each value present in the Set object, in value insertion order. *callbackfn* is called only for values of the Set which actually exist; it is not called for keys that have been deleted from the set.

If a *thisArg* parameter is provided, it will be used as the **this** value for each invocation of *callbackfn*. If it is not provided, **undefined** is used instead.

*callbackfn* is called with three arguments: the first two arguments are a value contained in the Set. The same value is passed for both arguments. The Set object being traversed is passed as the third argument.

The *callbackfn* is called with three arguments to be consistent with the call back functions used by **forEach** methods for Map and Array. For Sets, each item value is considered to be both the key and the value.

**forEach** does not directly mutate the object on which it is called but the object may be mutated by the calls to *callbackfn*.

Each value is normally visited only once. However, a value will be revisited if it is deleted after it has been visited and then re-added before the **forEach** call completes. Values that are deleted after the call to **forEach** begins and before being visited are not visited unless the value is added again before the **forEach** call completes. New values added after the call to **forEach** begins are visited.

### 24.2.3.7 Set.prototype.has ( *value* )

This method performs the following steps when called:

1. Let *S* be the **this** value.
2. Perform ? *RequireInternalSlot*(*S*, [[SetData]]).
3. For each element *e* of *S*.[[SetData]], do
  - a. If *e* is not empty and *SameValueZero*(*e*, *value*) is **true**, return **true**.
4. Return **false**.

### 24.2.3.8 Set.prototype.keys ( )

The initial value of the **"keys"** property is %Set.prototype.values%, defined in 24.2.3.10.

**NOTE** For iteration purposes, a Set appears similar to a Map where each entry has the same value for its key and value.

### 24.2.3.9 get Set.prototype.size

**Set.prototype.size** is an [accessor property](#) whose set accessor function is **undefined**. Its get accessor function performs the following steps when called:

1. Let *S* be the **this** value.
2. Perform ? [RequireInternalSlot](#)(*S*, [[SetData]]).
3. Let *count* be 0.
4. For each element *e* of *S*.[[SetData]], do
  - a. If *e* is not empty, set *count* to *count* + 1.
5. Return  $\mathbb{F}(\textit{count})$ .

### 24.2.3.10 Set.prototype.values ( )

This method performs the following steps when called:

1. Let *S* be the **this** value.
2. Return ? [CreateSetIterator](#)(*S*, value).

### 24.2.3.11 Set.prototype [ @@iterator ] ( )

The initial value of the [@@iterator](#) property is %Set.prototype.values%, defined in [24.2.3.10](#).

### 24.2.3.12 Set.prototype [ @@toStringTag ]

The initial value of the [@@toStringTag](#) property is the String value **"Set"**.

This property has the attributes { [[Writable]]: **false**, [[Enumerable]]: **false**, [[Configurable]]: **true** }.

## 24.2.4 Properties of Set Instances

Set instances are [ordinary objects](#) that inherit properties from the Set prototype. Set instances also have a [[SetData]] internal slot.

## 24.2.5 Set Iterator Objects

A Set Iterator is an [ordinary object](#), with the structure defined below, that represents a specific iteration over some specific Set instance object. There is not a named [constructor](#) for Set Iterator objects. Instead, set iterator objects are created by calling certain methods of Set instance objects.

### 24.2.5.1 CreateSetIterator ( *set*, *kind* )

The abstract operation CreateSetIterator takes arguments *set* (an [ECMAScript language value](#)) and *kind* (key+value or value) and returns either a [normal completion containing](#) a Generator or a [throw completion](#). It is used to create iterator objects for Set methods that return such iterators. It performs the following steps when called:

1. Perform ? [RequireInternalSlot](#)(*set*, [[SetData]]).
2. Let *closure* be a new [Abstract Closure](#) with no parameters that captures *set* and *kind* and performs the following steps when called:
  - a. Let *index* be 0.

- b. Let *entries* be *set*.[[SetData]].
- c. Let *numEntries* be the number of elements in *entries*.
- d. Repeat, while *index* < *numEntries*,
  - i. Let *e* be *entries*[*index*].
  - ii. Set *index* to *index* + 1.
  - iii. If *e* is not empty, then
    1. If *kind* is key+value, then
      - a. Let *result* be *CreateArrayFromList*(« *e*, *e* »).
      - b. Perform ? *GeneratorYield*(*CreateIterResultObject*(*result*, **false**)).
    2. Else,
      - a. **Assert**: *kind* is value.
      - b. Perform ? *GeneratorYield*(*CreateIterResultObject*(*e*, **false**)).
    3. NOTE: The number of elements in *entries* may have increased while execution of this abstract operation was paused by *Yield*.
    4. Set *numEntries* to the number of elements in *entries*.
  - e. Return **undefined**.
  3. Return *CreateIteratorFromClosure*(*closure*, "%SetIteratorPrototype%", %SetIteratorPrototype%).

### 24.2.5.2 The %SetIteratorPrototype% Object

The %SetIteratorPrototype% object:

- has properties that are inherited by all Set Iterator Objects.
- is an **ordinary object**.
- has a [[Prototype]] internal slot whose value is %IteratorPrototype%.
- has the following properties:

#### 24.2.5.2.1 %SetIteratorPrototype%.next ( )

1. Return ? *GeneratorResume*(**this** value, empty, "%SetIteratorPrototype%").

#### 24.2.5.2.2 %SetIteratorPrototype% [ @@toStringTag ]

The initial value of the @@toStringTag property is the String value **"Set Iterator"**.

This property has the attributes { [[Writable]]: **false**, [[Enumerable]]: **false**, [[Configurable]]: **true** }.

## 24.3 WeakMap Objects

WeakMaps are collections of key/value pairs where the keys are objects and/or symbols and values may be arbitrary **ECMAScript language values**. A WeakMap may be queried to see if it contains a key/value pair with a specific key, but no mechanism is provided for enumerating the values it holds as keys. In certain conditions, values which are not **live** are removed as WeakMap keys, as described in 9.10.3.

An implementation may impose an arbitrarily determined latency between the time a key/value pair of a WeakMap becomes inaccessible and the time when the key/value pair is removed from the WeakMap. If this latency was observable to ECMAScript program, it would be a source of indeterminacy that could impact program execution. For that reason, an ECMAScript implementation must not provide any means to observe a key of a WeakMap that does not require the observer to present the observed key.

WeakMaps must be implemented using either hash tables or other mechanisms that, on average, provide access times that are sublinear on the number of key/value pairs in the collection. The data structure used in this specification is only intended to describe the required observable semantics of WeakMaps. It is not intended to be a viable implementation model.

**NOTE** WeakMap and WeakSet are intended to provide mechanisms for dynamically associating state with an object or symbol in a manner that does not “leak” memory resources if, in the absence of the WeakMap or WeakSet instance, the object or symbol otherwise became inaccessible and subject to resource reclamation by the implementation’s garbage collection mechanisms. This characteristic can be achieved by using an inverted per-object/symbol mapping of WeakMap or WeakSet instances to keys. Alternatively, each WeakMap or WeakSet instance may internally store its key and value data, but this approach requires coordination between the WeakMap or WeakSet implementation and the garbage collector. The following references describe mechanism that may be useful to implementations of WeakMap and WeakSet:

Barry Hayes. 1997. Ephemerons: a new finalization mechanism. In *Proceedings of the 12th ACM SIGPLAN conference on Object-oriented programming, systems, languages, and applications (OOPSLA '97)*, A. Michael Berman (Ed.). ACM, New York, NY, USA, 176-183, <http://doi.acm.org/10.1145/263698.263733>.

Alexandra Barros, Roberto Ierusalimschy, Eliminating Cycles in Weak Tables. *Journal of Universal Computer Science - J.UCS*, vol. 14, no. 21, pp. 3481-3497, 2008, [http://www.jucs.org/jucs\\_14\\_21/eliminating\\_cycles\\_in\\_weak](http://www.jucs.org/jucs_14_21/eliminating_cycles_in_weak)

### 24.3.1 The WeakMap Constructor

The WeakMap **constructor**:

- is `%WeakMap%`.
- is the initial value of the **"WeakMap"** property of the [global object](#).
- creates and initializes a new WeakMap when called as a **constructor**.
- is not intended to be called as a function and will throw an exception when called in that manner.
- may be used as the value in an **extends** clause of a class definition. Subclass **constructors** that intend to inherit the specified WeakMap behaviour must include a **super** call to the WeakMap **constructor** to create and initialize the subclass instance with the internal state necessary to support the **WeakMap.prototype** built-in methods.

#### 24.3.1.1 WeakMap ( [ *iterable* ] )

This function performs the following steps when called:

1. If `NewTarget` is **undefined**, throw a **TypeError** exception.
2. Let `map` be ? [OrdinaryCreateFromConstructor](#)(`NewTarget`, **"%WeakMap.prototype%"**, « [\[\[WeakMapData\]\]](#) »).
3. Set `map.[[WeakMapData]]` to a new empty [List](#).
4. If `iterable` is either **undefined** or **null**, return `map`.
5. Let `adder` be ? [Get](#)(`map`, **"set"**).
6. If [IsCallable](#)(`adder`) is **false**, throw a **TypeError** exception.
7. Return ? [AddEntriesFromIterable](#)(`map`, `iterable`, `adder`).

**NOTE** If the parameter `iterable` is present, it is expected to be an object that implements an [@@iterator](#) method that returns an iterator object that produces a two element [array-like object](#) whose first element is a value that will be used as a WeakMap key and whose second element is the value to associate with that key.

## 24.3.2 Properties of the WeakMap Constructor

The WeakMap [constructor](#):

- has a [\[\[Prototype\]\]](#) internal slot whose value is [%Function.prototype%](#).
- has the following properties:

### 24.3.2.1 WeakMap.prototype

The initial value of [WeakMap.prototype](#) is the [WeakMap prototype object](#).

This property has the attributes { [\[\[Writable\]\]](#): **false**, [\[\[Enumerable\]\]](#): **false**, [\[\[Configurable\]\]](#): **false** }.

## 24.3.3 Properties of the WeakMap Prototype Object

The *WeakMap prototype object*:

- is [%WeakMap.prototype%](#).
- has a [\[\[Prototype\]\]](#) internal slot whose value is [%Object.prototype%](#).
- is an [ordinary object](#).
- does not have a [\[\[WeakMapData\]\]](#) internal slot.

### 24.3.3.1 WeakMap.prototype.constructor

The initial value of [WeakMap.prototype.constructor](#) is [%WeakMap%](#).

### 24.3.3.2 WeakMap.prototype.delete ( *key* )

This method performs the following steps when called:

1. Let *M* be the **this** value.
2. Perform ? [RequireInternalSlot](#)(*M*, [\[\[WeakMapData\]\]](#)).
3. If [CanBeHeldWeakly](#)(*key*) is **false**, return **false**.
4. For each [Record](#) { [\[\[Key\]\]](#), [\[\[Value\]\]](#) } *p* of *M*.[\[\[WeakMapData\]\]](#), do
  - a. If *p*.[\[\[Key\]\]](#) is not empty and [SameValue](#)(*p*.[\[\[Key\]\]](#), *key*) is **true**, then
    - i. Set *p*.[\[\[Key\]\]](#) to empty.
    - ii. Set *p*.[\[\[Value\]\]](#) to empty.
    - iii. Return **true**.
5. Return **false**.

**NOTE** The value empty is used as a specification device to indicate that an entry has been deleted. Actual implementations may take other actions such as physically removing the entry from internal data structures.

### 24.3.3.3 WeakMap.prototype.get ( *key* )

This method performs the following steps when called:

1. Let *M* be the **this** value.
2. Perform ? [RequireInternalSlot](#)(*M*, [\[\[WeakMapData\]\]](#)).
3. If [CanBeHeldWeakly](#)(*key*) is **false**, return **undefined**.



4. For each **Record** { **[[Key]]**, **[[Value]]** } *p* of *M*.**[[WeakMapData]]**, do
  - a. If *p*.**[[Key]]** is not empty and **SameValue**(*p*.**[[Key]]**, *key*) is **true**, return *p*.**[[Value]]**.
5. Return **undefined**.

#### 24.3.3.4 WeakMap.prototype.has ( *key* )

This method performs the following steps when called:

1. Let *M* be the **this** value.
2. Perform ? **RequireInternalSlot**(*M*, **[[WeakMapData]]**).
3. If **CanBeHeldWeakly**(*key*) is **false**, return **false**.
4. For each **Record** { **[[Key]]**, **[[Value]]** } *p* of *M*.**[[WeakMapData]]**, do
  - a. If *p*.**[[Key]]** is not empty and **SameValue**(*p*.**[[Key]]**, *key*) is **true**, return **true**.
5. Return **false**.

#### 24.3.3.5 WeakMap.prototype.set ( *key*, *value* )

This method performs the following steps when called:

1. Let *M* be the **this** value.
2. Perform ? **RequireInternalSlot**(*M*, **[[WeakMapData]]**).
3. If **CanBeHeldWeakly**(*key*) is **false**, throw a **TypeError** exception.
4. For each **Record** { **[[Key]]**, **[[Value]]** } *p* of *M*.**[[WeakMapData]]**, do
  - a. If *p*.**[[Key]]** is not empty and **SameValue**(*p*.**[[Key]]**, *key*) is **true**, then
    - i. Set *p*.**[[Value]]** to *value*.
    - ii. Return *M*.
5. Let *p* be the **Record** { **[[Key]]**: *key*, **[[Value]]**: *value* }.
6. Append *p* to *M*.**[[WeakMapData]]**.
7. Return *M*.

#### 24.3.3.6 WeakMap.prototype [ @@toStringTag ]

The initial value of the **@@toStringTag** property is the String value **"WeakMap"**.

This property has the attributes { **[[Writable]]**: **false**, **[[Enumerable]]**: **false**, **[[Configurable]]**: **true** }.

### 24.3.4 Properties of WeakMap Instances

WeakMap instances are **ordinary objects** that inherit properties from the WeakMap prototype. WeakMap instances also have a **[[WeakMapData]]** internal slot.

## 24.4 WeakSet Objects

WeakSets are collections of objects and/or symbols. A distinct object or symbol may only occur once as an element of a WeakSet's collection. A WeakSet may be queried to see if it contains a specific value, but no mechanism is provided for enumerating the values it holds. In certain conditions, values which are not **live** are removed as WeakSet elements, as described in 9.10.3.

An implementation may impose an arbitrarily determined latency between the time a value contained in a WeakSet becomes inaccessible and the time when the value is removed from the WeakSet. If this latency

was observable to ECMAScript program, it would be a source of indeterminacy that could impact program execution. For that reason, an ECMAScript implementation must not provide any means to determine if a WeakSet contains a particular value that does not require the observer to present the observed value.

WeakSets must be implemented using either hash tables or other mechanisms that, on average, provide access times that are sublinear on the number of elements in the collection. The data structure used in this specification is only intended to describe the required observable semantics of WeakSets. It is not intended to be a viable implementation model.

NOTE See the NOTE in 24.3.

## 24.4.1 The WeakSet Constructor

The WeakSet [constructor](#):

- is `%WeakSet%`.
- is the initial value of the **"WeakSet"** property of the [global object](#).
- creates and initializes a new WeakSet when called as a [constructor](#).
- is not intended to be called as a function and will throw an exception when called in that manner.
- may be used as the value in an **extends** clause of a class definition. Subclass [constructors](#) that intend to inherit the specified WeakSet behaviour must include a **super** call to the WeakSet [constructor](#) to create and initialize the subclass instance with the internal state necessary to support the **WeakSet.prototype** built-in methods.

### 24.4.1.1 WeakSet ( [ *iterable* ] )

This function performs the following steps when called:

1. If `NewTarget` is **undefined**, throw a **TypeError** exception.
2. Let `set` be `? OrdinaryCreateFromConstructor(NewTarget, "%WeakSet.prototype%", « [[WeakSetData]] »)`.
3. Set `set.[WeakSetData]` to a new empty [List](#).
4. If `iterable` is either **undefined** or **null**, return `set`.
5. Let `adder` be `? Get(set, "add")`.
6. If `IsCallable(adder)` is **false**, throw a **TypeError** exception.
7. Let `iteratorRecord` be `? GetIterator(iterable, sync)`.
8. Repeat,
  - a. Let `next` be `? IteratorStep(iteratorRecord)`.
  - b. If `next` is **false**, return `set`.
  - c. Let `nextValue` be `? IteratorValue(next)`.
  - d. Let `status` be `Completion(Call(adder, set, « nextValue »))`.
  - e. `IfAbruptCloseIterator(status, iteratorRecord)`.

## 24.4.2 Properties of the WeakSet Constructor

The WeakSet [constructor](#):

- has a `[[Prototype]]` internal slot whose value is `%Function.prototype%`.
- has the following properties:

### 24.4.2.1 WeakSet.prototype

The initial value of `WeakSet.prototype` is the [WeakSet prototype object](#).

This property has the attributes { `[[Writable]]`: **false**, `[[Enumerable]]`: **false**, `[[Configurable]]`: **false** }.

### 24.4.3 Properties of the WeakSet Prototype Object

The *WeakSet prototype object*:

- is `%WeakSet.prototype%`.
- has a `[[Prototype]]` internal slot whose value is `%Object.prototype%`.
- is an [ordinary object](#).
- does not have a `[[WeakSetData]]` internal slot.

#### 24.4.3.1 WeakSet.prototype.add ( *value* )

This method performs the following steps when called:

1. Let *S* be the **this** value.
2. Perform ? [RequireInternalSlot](#)(*S*, `[[WeakSetData]]`).
3. If [CanBeHeldWeakly](#)(*value*) is **false**, throw a **TypeError** exception.
4. For each element *e* of *S*.`[[WeakSetData]]`, do
  - a. If *e* is not empty and [SameValue](#)(*e*, *value*) is **true**, then
    - i. Return *S*.
5. Append *value* to *S*.`[[WeakSetData]]`.
6. Return *S*.

#### 24.4.3.2 WeakSet.prototype.constructor

The initial value of `WeakSet.prototype.constructor` is `%WeakSet%`.

#### 24.4.3.3 WeakSet.prototype.delete ( *value* )

This method performs the following steps when called:

1. Let *S* be the **this** value.
2. Perform ? [RequireInternalSlot](#)(*S*, `[[WeakSetData]]`).
3. If [CanBeHeldWeakly](#)(*value*) is **false**, return **false**.
4. For each element *e* of *S*.`[[WeakSetData]]`, do
  - a. If *e* is not empty and [SameValue](#)(*e*, *value*) is **true**, then
    - i. Replace the element of *S*.`[[WeakSetData]]` whose value is *e* with an element whose value is empty.
    - ii. Return **true**.
5. Return **false**.

**NOTE** The value empty is used as a specification device to indicate that an entry has been deleted. Actual implementations may take other actions such as physically removing the entry from internal data structures.

#### 24.4.3.4 WeakSet.prototype.has ( *value* )

This method performs the following steps when called:

1. Let *S* be the **this** value.

2. Perform ? [RequireInternalSlot](#)(*S*, [\[\[WeakSetData\]\]](#)).
3. If [CanBeHeldWeakly](#)(*value*) is **false**, return **false**.
4. For each element *e* of *S*.[\[\[WeakSetData\]\]](#), do
  - a. If *e* is not empty and [SameValue](#)(*e*, *value*) is **true**, return **true**.
5. Return **false**.

#### 24.4.3.5 WeakSet.prototype [ @@toStringTag ]

The initial value of the [@@toStringTag](#) property is the String value **"WeakSet"**.

This property has the attributes { [\[\[Writable\]\]](#): **false**, [\[\[Enumerable\]\]](#): **false**, [\[\[Configurable\]\]](#): **true** }.

#### 24.4.4 Properties of WeakSet Instances

WeakSet instances are [ordinary objects](#) that inherit properties from the WeakSet prototype. WeakSet instances also have a [\[\[WeakSetData\]\]](#) internal slot.

## 25 Structured Data

### 25.1 ArrayBuffer Objects

#### 25.1.1 Notation

The descriptions below in this section, [25.4](#), and [29](#) use the read-modify-write modification function internal data structure.

A *read-modify-write modification function* is a mathematical function that is notationally represented as an abstract closure that takes two [Lists of byte values](#) as arguments and returns a [List of byte values](#). These abstract closures satisfy all of the following properties:

- They perform all their algorithm steps atomically.
- Their individual algorithm steps are not observable.

**NOTE** To aid verifying that a read-modify-write modification function's algorithm steps constitute a pure, mathematical function, the following editorial conventions are recommended:

- They do not access, directly or transitively via invoked [abstract operations](#) and abstract closures, any language or specification values except their parameters and captured values.
- They do not return [Completion Records](#).

#### 25.1.2 Abstract Operations For ArrayBuffer Objects

##### 25.1.2.1 AllocateArrayBuffer ( *constructor*, *byteLength* )

The abstract operation `AllocateArrayBuffer` takes arguments *constructor* (a [constructor](#)) and *byteLength* (a non-negative [integer](#)) and returns either a [normal completion containing](#) an `ArrayBuffer` or a [throw completion](#). It is used to create an `ArrayBuffer`. It performs the following steps when called:

1. Let *obj* be ? OrdinaryCreateFromConstructor(*constructor*, "%ArrayBuffer.prototype%", « [[ArrayBufferData]], [[ArrayBufferByteLength]], [[ArrayBufferDetachKey]] »).
2. Let *block* be ? CreateByteDataBlock(*byteLength*).
3. Set *obj*.[[ArrayBufferData]] to *block*.
4. Set *obj*.[[ArrayBufferByteLength]] to *byteLength*.
5. Return *obj*.

### 25.1.2.2 IsDetachedBuffer ( *arrayBuffer* )

The abstract operation IsDetachedBuffer takes argument *arrayBuffer* (an ArrayBuffer or a SharedArrayBuffer) and returns a Boolean. It performs the following steps when called:

1. If *arrayBuffer*.[[ArrayBufferData]] is **null**, return **true**.
2. Return **false**.

### 25.1.2.3 DetachArrayBuffer ( *arrayBuffer* [ , *key* ] )

The abstract operation DetachArrayBuffer takes argument *arrayBuffer* (an ArrayBuffer) and optional argument *key* (anything) and returns either a **normal completion containing unused** or a **throw completion**. It performs the following steps when called:

1. **Assert:** IsSharedArrayBuffer(*arrayBuffer*) is **false**.
2. If *key* is not present, set *key* to **undefined**.
3. If *arrayBuffer*.[[ArrayBufferDetachKey]] is not *key*, throw a **TypeError** exception.
4. Set *arrayBuffer*.[[ArrayBufferData]] to **null**.
5. Set *arrayBuffer*.[[ArrayBufferByteLength]] to 0.
6. Return unused.

**NOTE** Detaching an ArrayBuffer instance disassociates the **Data Block** used as its backing store from the instance and sets the byte length of the buffer to 0. No operations defined by this specification use the DetachArrayBuffer abstract operation. However, an ECMAScript **host** or implementation may define such operations.

### 25.1.2.4 CloneArrayBuffer ( *srcBuffer*, *srcByteOffset*, *srcLength* )

The abstract operation CloneArrayBuffer takes arguments *srcBuffer* (an ArrayBuffer or a SharedArrayBuffer), *srcByteOffset* (a non-negative **integer**), and *srcLength* (a non-negative **integer**) and returns either a **normal completion containing** an ArrayBuffer or a **throw completion**. It creates a new ArrayBuffer whose data is a copy of *srcBuffer*'s data over the range starting at *srcByteOffset* and continuing for *srcLength* bytes. It performs the following steps when called:

1. **Assert:** IsDetachedBuffer(*srcBuffer*) is **false**.
2. Let *targetBuffer* be ? AllocateArrayBuffer(%ArrayBuffer%, *srcLength*).
3. Let *srcBlock* be *srcBuffer*.[[ArrayBufferData]].
4. Let *targetBlock* be *targetBuffer*.[[ArrayBufferData]].
5. Perform CopyDataBlockBytes(*targetBlock*, 0, *srcBlock*, *srcByteOffset*, *srcLength*).
6. Return *targetBuffer*.

### 25.1.2.5 IsUnsignedElementType ( *type* )

The abstract operation IsUnsignedElementType takes argument *type* (a TypedArray element type) and returns a Boolean. It verifies if the argument *type* is an unsigned TypedArray element type. It performs the

following steps when called:

1. If *type* is one of Uint8, Uint8C, Uint16, Uint32, or BigUint64, return **true**.
2. Return **false**.

### 25.1.2.6 IsUnclampedIntegerElementType ( *type* )

The abstract operation IsUnclampedIntegerElementType takes argument *type* (a TypedArray element type) and returns a Boolean. It verifies if the argument *type* is an Integer TypedArray element type not including Uint8C. It performs the following steps when called:

1. If *type* is one of Int8, Uint8, Int16, Uint16, Int32, or Uint32, return **true**.
2. Return **false**.

### 25.1.2.7 IsBigIntElementType ( *type* )

The abstract operation IsBigIntElementType takes argument *type* (a TypedArray element type) and returns a Boolean. It verifies if the argument *type* is a BigInt TypedArray element type. It performs the following steps when called:

1. If *type* is either BigUint64 or BigInt64, return **true**.
2. Return **false**.

### 25.1.2.8 IsNoTearConfiguration ( *type*, *order* )

The abstract operation IsNoTearConfiguration takes arguments *type* (a TypedArray element type) and *order* (SeqCst, Unordered, or Init) and returns a Boolean. It performs the following steps when called:

1. If IsUnclampedIntegerElementType(*type*) is **true**, return **true**.
2. If IsBigIntElementType(*type*) is **true** and *order* is neither Init nor Unordered, return **true**.
3. Return **false**.

### 25.1.2.9 RawBytesToNumeric ( *type*, *rawBytes*, *isLittleEndian* )

The abstract operation RawBytesToNumeric takes arguments *type* (a TypedArray element type), *rawBytes* (a List of byte values), and *isLittleEndian* (a Boolean) and returns a Number or a BigInt. It performs the following steps when called:

1. Let *elementSize* be the Element Size value specified in Table 68 for Element Type *type*.
2. If *isLittleEndian* is **false**, reverse the order of the elements of *rawBytes*.
3. If *type* is Float32, then
  - a. Let *value* be the byte elements of *rawBytes* concatenated and interpreted as a little-endian bit string encoding of an IEEE 754-2019 binary32 value.
  - b. If *value* is an IEEE 754-2019 binary32 NaN value, return the NaN Number value.
  - c. Return the Number value that corresponds to *value*.
4. If *type* is Float64, then
  - a. Let *value* be the byte elements of *rawBytes* concatenated and interpreted as a little-endian bit string encoding of an IEEE 754-2019 binary64 value.
  - b. If *value* is an IEEE 754-2019 binary64 NaN value, return the NaN Number value.
  - c. Return the Number value that corresponds to *value*.
5. If IsUnsignedElementType(*type*) is **true**, then
  - a. Let *intValue* be the byte elements of *rawBytes* concatenated and interpreted as a bit string encoding of an unsigned little-endian binary number.

6. Else,
  - a. Let *intValue* be the byte elements of *rawBytes* concatenated and interpreted as a bit string encoding of a binary little-endian two's complement number of bit length *elementSize* × 8.
7. If *IsBigIntElementType*(*type*) is **true**, return the BigInt value that corresponds to *intValue*.
8. Otherwise, return the Number value that corresponds to *intValue*.

### 25.1.2.10 GetValueFromBuffer ( *arrayBuffer*, *byteIndex*, *type*, *isTypedArray*, *order* [ , *isLittleEndian* ] )

The abstract operation *GetValueFromBuffer* takes arguments *arrayBuffer* (an *ArrayBuffer* or *SharedArrayBuffer*), *byteIndex* (a non-negative *integer*), *type* (a *TypedArray* element type), *isTypedArray* (a Boolean), and *order* (*SeqCst* or *Unordered*) and optional argument *isLittleEndian* (a Boolean) and returns a *Number* or a *BigInt*. It performs the following steps when called:

1. **Assert**: *IsDetachedBuffer*(*arrayBuffer*) is **false**.
2. **Assert**: There are sufficient bytes in *arrayBuffer* starting at *byteIndex* to represent a value of *type*.
3. Let *block* be *arrayBuffer*.[[*ArrayBufferData*]].
4. Let *elementSize* be the Element Size value specified in Table 68 for Element Type *type*.
5. If *IsSharedArrayBuffer*(*arrayBuffer*) is **true**, then
  - a. Let *execution* be the [[*CandidateExecution*]] field of the surrounding agent's *Agent Record*.
  - b. Let *eventsRecord* be the *Agent Events Record* of *execution*.[[*EventsRecords*]] whose [[*AgentSignifier*]] is *AgentSignifier*().
  - c. If *isTypedArray* is **true** and *IsNoTearConfiguration*(*type*, *order*) is **true**, let *noTear* be **true**; otherwise let *noTear* be **false**.
  - d. Let *rawValue* be a *List* of length *elementSize* whose elements are nondeterministically chosen *byte* values.
  - e. NOTE: In implementations, *rawValue* is the result of a non-atomic or atomic read instruction on the underlying hardware. The nondeterminism is a semantic prescription of the *memory model* to describe observable behaviour of hardware with weak consistency.
  - f. Let *readEvent* be *ReadSharedMemory* { [[*Order*]]: *order*, [[*NoTear*]]: *noTear*, [[*Block*]]: *block*, [[*ByteIndex*]]: *byteIndex*, [[*ElementSize*]]: *elementSize* }.
  - g. Append *readEvent* to *eventsRecord*.[[*EventList*]].
  - h. Append *Chosen Value Record* { [[*Event*]]: *readEvent*, [[*ChosenValue*]]: *rawValue* } to *execution*.[[*ChosenValues*]].
6. Else, let *rawValue* be a *List* whose elements are bytes from *block* at indices in the *interval* from *byteIndex* (inclusive) to *byteIndex* + *elementSize* (exclusive).
7. **Assert**: The number of elements in *rawValue* is *elementSize*.
8. If *isLittleEndian* is not present, set *isLittleEndian* to the value of the [[*LittleEndian*]] field of the surrounding agent's *Agent Record*.
9. Return *RawBytesToNumeric*(*type*, *rawValue*, *isLittleEndian*).

### 25.1.2.11 NumericToRawBytes ( *type*, *value*, *isLittleEndian* )

The abstract operation *NumericToRawBytes* takes arguments *type* (a *TypedArray* element type), *value* (a *Number* or a *BigInt*), and *isLittleEndian* (a Boolean) and returns a *List* of *byte* values. It performs the following steps when called:

1. If *type* is *Float32*, then
  - a. Let *rawBytes* be a *List* whose elements are the 4 bytes that are the result of converting *value* to *IEEE 754-2019* binary32 format using *roundTiesToEven* mode. The bytes are arranged in little endian order. If *value* is **NaN**, *rawBytes* may be set to any implementation chosen *IEEE 754-*

- 2019 binary32 format Not-a-Number encoding. An implementation must always choose the same encoding for each implementation distinguishable **NaN** value.
2. Else if *type* is Float64, then
    - a. Let *rawBytes* be a List whose elements are the 8 bytes that are the IEEE 754-2019 binary64 format encoding of *value*. The bytes are arranged in little endian order. If *value* is **NaN**, *rawBytes* may be set to any implementation chosen IEEE 754-2019 binary64 format Not-a-Number encoding. An implementation must always choose the same encoding for each implementation distinguishable **NaN** value.
  3. Else,
    - a. Let *n* be the Element Size value specified in Table 68 for Element Type *type*.
    - b. Let *convOp* be the abstract operation named in the Conversion Operation column in Table 68 for Element Type *type*.
    - c. Let *intValue* be  $\mathbb{R}(\text{convOp}(\text{value}))$ .
    - d. If *intValue*  $\geq 0$ , then
      - i. Let *rawBytes* be a List whose elements are the *n*-byte binary encoding of *intValue*. The bytes are ordered in little endian order.
    - e. Else,
      - i. Let *rawBytes* be a List whose elements are the *n*-byte binary two's complement encoding of *intValue*. The bytes are ordered in little endian order.
  4. If *isLittleEndian* is **false**, reverse the order of the elements of *rawBytes*.
  5. Return *rawBytes*.

### 25.1.2.12 SetValueInBuffer ( *arrayBuffer*, *byteIndex*, *type*, *value*, *isTypedArray*, *order* [ , *isLittleEndian* ] )

The abstract operation SetValueInBuffer takes arguments *arrayBuffer* (an ArrayBuffer or SharedArrayBuffer), *byteIndex* (a non-negative integer), *type* (a TypedArray element type), *value* (a Number or a BigInt), *isTypedArray* (a Boolean), and *order* (SeqCst, Unordered, or Init) and optional argument *isLittleEndian* (a Boolean) and returns unused. It performs the following steps when called:

1. Assert: IsDetachedBuffer(*arrayBuffer*) is **false**.
2. Assert: There are sufficient bytes in *arrayBuffer* starting at *byteIndex* to represent a value of *type*.
3. Assert: *value* is a BigInt if IsBigIntElementType(*type*) is **true**; otherwise, *value* is a Number.
4. Let *block* be *arrayBuffer*.[[ArrayBufferData]].
5. Let *elementSize* be the Element Size value specified in Table 68 for Element Type *type*.
6. If *isLittleEndian* is not present, set *isLittleEndian* to the value of the [[LittleEndian]] field of the surrounding agent's Agent Record.
7. Let *rawBytes* be NumericToRawBytes(*type*, *value*, *isLittleEndian*).
8. If IsSharedArrayBuffer(*arrayBuffer*) is **true**, then
  - a. Let *execution* be the [[CandidateExecution]] field of the surrounding agent's Agent Record.
  - b. Let *eventsRecord* be the Agent Events Record of *execution*.[[EventsRecords]] whose [[AgentSignifier]] is AgentSignifier().
  - c. If *isTypedArray* is **true** and IsNoTearConfiguration(*type*, *order*) is **true**, let *noTear* be **true**; otherwise let *noTear* be **false**.
  - d. Append WriteSharedMemory { [[Order]]: *order*, [[NoTear]]: *noTear*, [[Block]]: *block*, [[ByteIndex]]: *byteIndex*, [[ElementSize]]: *elementSize*, [[Payload]]: *rawBytes* } to *eventsRecord*.[[EventList]].
9. Else, store the individual bytes of *rawBytes* into *block*, starting at *block*[*byteIndex*].
10. Return unused.



### 25.1.2.13 GetModifySetValueInBuffer ( *arrayBuffer*, *byteIndex*, *type*, *value*, *op* [ , *isLittleEndian* ] )

The abstract operation `GetModifySetValueInBuffer` takes arguments *arrayBuffer* (an `ArrayBuffer` or a `SharedArrayBuffer`), *byteIndex* (a non-negative `integer`), *type* (a `TypedArray` element type), *value* (a `Number` or a `BigInt`), and *op* (a `read-modify-write` modification function) and optional argument *isLittleEndian* (a `Boolean`) and returns a `Number` or a `BigInt`. It performs the following steps when called:

1. **Assert:** `IsDetachedBuffer(arrayBuffer)` is **false**.
2. **Assert:** There are sufficient bytes in *arrayBuffer* starting at *byteIndex* to represent a value of *type*.
3. **Assert:** *value* is a `BigInt` if `IsBigIntElementType(type)` is **true**; otherwise, *value* is a `Number`.
4. Let *block* be *arrayBuffer*.[[`ArrayBufferData`]].
5. Let *elementSize* be the Element Size value specified in Table 68 for Element Type *type*.
6. If *isLittleEndian* is not present, set *isLittleEndian* to the value of the [[`LittleEndian`]] field of the surrounding agent's Agent Record.
7. Let *rawBytes* be `NumericToRawBytes(type, value, isLittleEndian)`.
8. If `IsSharedArrayBuffer(arrayBuffer)` is **true**, then
  - a. Let *execution* be the [[`CandidateExecution`]] field of the surrounding agent's Agent Record.
  - b. Let *eventsRecord* be the Agent Events Record of *execution*.[[`EventsRecords`]] whose [[`AgentSignifier`]] is `AgentSignifier()`.
  - c. Let *rawBytesRead* be a List of length *elementSize* whose elements are nondeterministically chosen byte values.
  - d. NOTE: In implementations, *rawBytesRead* is the result of a load-link, of a load-exclusive, or of an operand of a read-modify-write instruction on the underlying hardware. The nondeterminism is a semantic prescription of the `memory model` to describe observable behaviour of hardware with weak consistency.
  - e. Let *rmwEvent* be `ReadModifyWriteSharedMemory` { [[`Order`]]: `SeqCst`, [[`NoTear`]]: **true**, [[`Block`]]: *block*, [[`ByteIndex`]]: *byteIndex*, [[`ElementSize`]]: *elementSize*, [[`Payload`]]: *rawBytes*, [[`ModifyOp`]]: *op* }.
  - f. Append *rmwEvent* to *eventsRecord*.[[`EventList`]].
  - g. Append `Chosen Value Record` { [[`Event`]]: *rmwEvent*, [[`ChosenValue`]]: *rawBytesRead* } to *execution*.[[`ChosenValues`]].
9. Else,
  - a. Let *rawBytesRead* be a List of length *elementSize* whose elements are the sequence of *elementSize* bytes starting with *block*[*byteIndex*].
  - b. Let *rawBytesModified* be *op*(*rawBytesRead*, *rawBytes*).
  - c. Store the individual bytes of *rawBytesModified* into *block*, starting at *block*[*byteIndex*].
10. Return `RawBytesToNumeric(type, rawBytesRead, isLittleEndian)`.

### 25.1.3 The `ArrayBuffer` Constructor

The `ArrayBuffer` constructor:

- is `%ArrayBuffer%`.
- is the initial value of the "**ArrayBuffer**" property of the `global object`.
- creates and initializes a new `ArrayBuffer` when called as a `constructor`.
- is not intended to be called as a function and will throw an exception when called in that manner.
- may be used as the value of an **extends** clause of a class definition. Subclass `constructors` that intend to inherit the specified `ArrayBuffer` behaviour must include a **super** call to the `ArrayBuffer` `constructor` to create and initialize subclass instances with the internal state necessary to support the `ArrayBuffer.prototype` built-in methods.

### 25.1.3.1 ArrayBuffer ( *length* )

This function performs the following steps when called:

1. If *NewTarget* is **undefined**, throw a **TypeError** exception.
2. Let *byteLength* be ? *ToIndex*(*length*).
3. Return ? *AllocateArrayBuffer*(*NewTarget*, *byteLength*).

### 25.1.4 Properties of the ArrayBuffer Constructor

The *ArrayBuffer* constructor:

- has a `[[Prototype]]` internal slot whose value is `%Function.prototype%`.
- has the following properties:

#### 25.1.4.1 *ArrayBuffer.isView* ( *arg* )

This function performs the following steps when called:

1. If *arg* is not an *Object*, return **false**.
2. If *arg* has a `[[ViewedArrayBuffer]]` internal slot, return **true**.
3. Return **false**.

#### 25.1.4.2 *ArrayBuffer.prototype*

The initial value of *ArrayBuffer.prototype* is the *ArrayBuffer* prototype object.

This property has the attributes { `[[Writable]]`: **false**, `[[Enumerable]]`: **false**, `[[Configurable]]`: **false** }.

#### 25.1.4.3 *get* *ArrayBuffer* [ *@@species* ]

*ArrayBuffer*[*@@species*] is an *accessor property* whose set accessor function is **undefined**. Its get accessor function performs the following steps when called:

1. Return the **this** value.

The value of the **"name"** property of this function is **"get [Symbol.species]"**.

**NOTE** *ArrayBuffer* prototype methods normally use their **this** value's *constructor* to create a derived object. However, a subclass *constructor* may over-ride that default behaviour by redefining its *@@species* property.

### 25.1.5 Properties of the ArrayBuffer Prototype Object

The *ArrayBuffer* prototype object:

- is `%ArrayBuffer.prototype%`.
- has a `[[Prototype]]` internal slot whose value is `%Object.prototype%`.
- is an *ordinary object*.
- does not have an `[[ArrayBufferData]]` or `[[ArrayBufferByteLength]]` internal slot.

### 25.1.5.1 `get ArrayBuffer.prototype.byteLength`

`ArrayBuffer.prototype.byteLength` is an [accessor property](#) whose set accessor function is `undefined`. Its get accessor function performs the following steps when called:

1. Let *O* be the **this** value.
2. Perform ? [RequireInternalSlot](#)(*O*, [[ArrayBufferData]]).
3. If [IsSharedArrayBuffer](#)(*O*) is **true**, throw a **TypeError** exception.
4. If [IsDetachedBuffer](#)(*O*) is **true**, return **+0**<sub>F</sub>.
5. Let *length* be *O*.[[ArrayBufferByteLength]].
6. Return  $\mathbb{F}(\textit{length})$ .

### 25.1.5.2 `ArrayBuffer.prototype.constructor`

The initial value of `ArrayBuffer.prototype.constructor` is `%ArrayBuffer%`.

### 25.1.5.3 `ArrayBuffer.prototype.slice ( start, end )`

This method performs the following steps when called:

1. Let *O* be the **this** value.
2. Perform ? [RequireInternalSlot](#)(*O*, [[ArrayBufferData]]).
3. If [IsSharedArrayBuffer](#)(*O*) is **true**, throw a **TypeError** exception.
4. If [IsDetachedBuffer](#)(*O*) is **true**, throw a **TypeError** exception.
5. Let *len* be *O*.[[ArrayBufferByteLength]].
6. Let *relativeStart* be ? [ToIntegerOrInfinity](#)(*start*).
7. If *relativeStart* =  $-\infty$ , let *first* be 0.
8. Else if *relativeStart* < 0, let *first* be  $\max(\textit{len} + \textit{relativeStart}, 0)$ .
9. Else, let *first* be  $\min(\textit{relativeStart}, \textit{len})$ .
10. If *end* is **undefined**, let *relativeEnd* be *len*; else let *relativeEnd* be ? [ToIntegerOrInfinity](#)(*end*).
11. If *relativeEnd* =  $-\infty$ , let *final* be 0.
12. Else if *relativeEnd* < 0, let *final* be  $\max(\textit{len} + \textit{relativeEnd}, 0)$ .
13. Else, let *final* be  $\min(\textit{relativeEnd}, \textit{len})$ .
14. Let *newLen* be  $\max(\textit{final} - \textit{first}, 0)$ .
15. Let *ctor* be ? [SpeciesConstructor](#)(*O*, `%ArrayBuffer%`).
16. Let *new* be ? [Construct](#)(*ctor*, «  $\mathbb{F}(\textit{newLen})$  »).
17. Perform ? [RequireInternalSlot](#)(*new*, [[ArrayBufferData]]).
18. If [IsSharedArrayBuffer](#)(*new*) is **true**, throw a **TypeError** exception.
19. If [IsDetachedBuffer](#)(*new*) is **true**, throw a **TypeError** exception.
20. If [SameValue](#)(*new*, *O*) is **true**, throw a **TypeError** exception.
21. If *new*.[[ArrayBufferByteLength]] < *newLen*, throw a **TypeError** exception.
22. NOTE: Side-effects of the above steps may have detached *O*.
23. If [IsDetachedBuffer](#)(*O*) is **true**, throw a **TypeError** exception.
24. Let *fromBuf* be *O*.[[ArrayBufferData]].
25. Let *toBuf* be *new*.[[ArrayBufferData]].
26. Perform [CopyDataBlockBytes](#)(*toBuf*, 0, *fromBuf*, *first*, *newLen*).
27. Return *new*.

#### 25.1.5.4 `ArrayBuffer.prototype` [ `@@toStringTag` ]

The initial value of the `@@toStringTag` property is the String value `"ArrayBuffer"`.

This property has the attributes { `[[Writable]]`: **false**, `[[Enumerable]]`: **false**, `[[Configurable]]`: **true** }.

#### 25.1.6 Properties of `ArrayBuffer` Instances

`ArrayBuffer` instances inherit properties from the [ArrayBuffer prototype object](#). `ArrayBuffer` instances each have an `[[ArrayBufferData]]` internal slot, an `[[ArrayBufferByteLength]]` internal slot, and an `[[ArrayBufferDetachKey]]` internal slot.

`ArrayBuffer` instances whose `[[ArrayBufferData]]` is **null** are considered to be detached and all operators to access or modify data contained in the `ArrayBuffer` instance will fail.

`ArrayBuffer` instances whose `[[ArrayBufferDetachKey]]` is set to a value other than **undefined** need to have all [DetachArrayBuffer](#) calls passing that same "detach key" as an argument, otherwise a `TypeError` will result. This internal slot is only ever set by certain embedding environments, not by algorithms in this specification.

### 25.2 SharedArrayBuffer Objects

#### 25.2.1 Abstract Operations for SharedArrayBuffer Objects

##### 25.2.1.1 `AllocateSharedArrayBuffer` ( *constructor*, *byteLength* )

The abstract operation `AllocateSharedArrayBuffer` takes arguments *constructor* (a [constructor](#)) and *byteLength* (a non-negative [integer](#)) and returns either a [normal completion containing](#) a `SharedArrayBuffer` or a [throw completion](#). It is used to create a `SharedArrayBuffer`. It performs the following steps when called:

1. Let *obj* be ? [OrdinaryCreateFromConstructor](#)(*constructor*, "%SharedArrayBuffer.prototype%", « `[[ArrayBufferData]]`, `[[ArrayBufferByteLength]]` »).
2. Let *block* be ? [CreateSharedByteDataBlock](#)(*byteLength*).
3. Set *obj*.`[[ArrayBufferData]]` to *block*.
4. Set *obj*.`[[ArrayBufferByteLength]]` to *byteLength*.
5. Return *obj*.

##### 25.2.1.2 `IsSharedArrayBuffer` ( *obj* )

The abstract operation `IsSharedArrayBuffer` takes argument *obj* (an `ArrayBuffer` or a `SharedArrayBuffer`) and returns a Boolean. It tests whether an object is an `ArrayBuffer`, a `SharedArrayBuffer`, or a subtype of either. It performs the following steps when called:

1. Let *bufferData* be *obj*.`[[ArrayBufferData]]`.
2. If *bufferData* is **null**, return **false**.
3. If *bufferData* is a [Data Block](#), return **false**.
4. [Assert](#): *bufferData* is a [Shared Data Block](#).
5. Return **true**.

#### 25.2.2 The `SharedArrayBuffer` Constructor

The `SharedArrayBuffer` [constructor](#):

- is `%SharedArrayBuffer%`.
- is the initial value of the `"SharedArrayBuffer"` property of the [global object](#), if that property is present (see below).
- creates and initializes a new `SharedArrayBuffer` when called as a [constructor](#).
- is not intended to be called as a function and will throw an exception when called in that manner.
- may be used as the value of an `extends` clause of a class definition. Subclass [constructors](#) that intend to inherit the specified `SharedArrayBuffer` behaviour must include a `super` call to the `SharedArrayBuffer` [constructor](#) to create and initialize subclass instances with the internal state necessary to support the `SharedArrayBuffer.prototype` built-in methods.

Whenever a [host](#) does not provide concurrent access to `SharedArrayBuffers` it may omit the `"SharedArrayBuffer"` property of the [global object](#).

**NOTE** Unlike an `ArrayBuffer`, a `SharedArrayBuffer` cannot become detached, and its internal `[[ArrayBufferData]]` slot is never `null`.

### 25.2.2.1 SharedArrayBuffer ( *length* )

This function performs the following steps when called:

1. If `NewTarget` is `undefined`, throw a `TypeError` exception.
2. Let `byteLength` be `? ToIndex(length)`.
3. Return `? AllocateSharedArrayBuffer(NewTarget, byteLength)`.

### 25.2.3 Properties of the SharedArrayBuffer Constructor

The `SharedArrayBuffer` [constructor](#):

- has a `[[Prototype]]` internal slot whose value is `%Function.prototype%`.
- has the following properties:

#### 25.2.3.1 SharedArrayBuffer.prototype

The initial value of `SharedArrayBuffer.prototype` is the [SharedArrayBuffer prototype object](#).

This property has the attributes `{ [[Writable]]: false, [[Enumerable]]: false, [[Configurable]]: false }`.

#### 25.2.3.2 get SharedArrayBuffer [ @@species ]

`SharedArrayBuffer[@@species]` is an [accessor property](#) whose set accessor function is `undefined`. Its get accessor function performs the following steps when called:

1. Return the `this` value.

The value of the `"name"` property of this function is `"get [Symbol.species]"`.

### 25.2.4 Properties of the SharedArrayBuffer Prototype Object

The `SharedArrayBuffer` [prototype object](#):

- is `%SharedArrayBuffer.prototype%`.
- has a `[[Prototype]]` internal slot whose value is `%Object.prototype%`.
- is an [ordinary object](#).

- does not have an `[[ArrayBufferData]]` or `[[ArrayBufferByteLength]]` internal slot.

#### 25.2.4.1 `get SharedArrayBuffer.prototype.byteLength`

`SharedArrayBuffer.prototype.byteLength` is an [accessor property](#) whose set accessor function is `undefined`. Its get accessor function performs the following steps when called:

1. Let *O* be the **this** value.
2. Perform ? [RequireInternalSlot](#)(*O*, `[[ArrayBufferData]]`).
3. If [IsSharedArrayBuffer](#)(*O*) is **false**, throw a **TypeError** exception.
4. Let *length* be *O*.`[[ArrayBufferByteLength]]`.
5. Return  $\mathbb{F}(\textit{length})$ .

#### 25.2.4.2 `SharedArrayBuffer.prototype.constructor`

The initial value of `SharedArrayBuffer.prototype.constructor` is `%SharedArrayBuffer%`.

#### 25.2.4.3 `SharedArrayBuffer.prototype.slice ( start, end )`

This method performs the following steps when called:

1. Let *O* be the **this** value.
2. Perform ? [RequireInternalSlot](#)(*O*, `[[ArrayBufferData]]`).
3. If [IsSharedArrayBuffer](#)(*O*) is **false**, throw a **TypeError** exception.
4. Let *len* be *O*.`[[ArrayBufferByteLength]]`.
5. Let *relativeStart* be ? [ToIntegerOrInfinity](#)(*start*).
6. If *relativeStart* =  $-\infty$ , let *first* be 0.
7. Else if *relativeStart* < 0, let *first* be  $\max(\textit{len} + \textit{relativeStart}, 0)$ .
8. Else, let *first* be  $\min(\textit{relativeStart}, \textit{len})$ .
9. If *end* is **undefined**, let *relativeEnd* be *len*; else let *relativeEnd* be ? [ToIntegerOrInfinity](#)(*end*).
10. If *relativeEnd* =  $-\infty$ , let *final* be 0.
11. Else if *relativeEnd* < 0, let *final* be  $\max(\textit{len} + \textit{relativeEnd}, 0)$ .
12. Else, let *final* be  $\min(\textit{relativeEnd}, \textit{len})$ .
13. Let *newLen* be  $\max(\textit{final} - \textit{first}, 0)$ .
14. Let *ctor* be ? [SpeciesConstructor](#)(*O*, `%SharedArrayBuffer%`).
15. Let *new* be ? [Construct](#)(*ctor*, «  $\mathbb{F}(\textit{newLen})$  »).
16. Perform ? [RequireInternalSlot](#)(*new*, `[[ArrayBufferData]]`).
17. If [IsSharedArrayBuffer](#)(*new*) is **false**, throw a **TypeError** exception.
18. If *new*.`[[ArrayBufferData]]` is *O*.`[[ArrayBufferData]]`, throw a **TypeError** exception.
19. If *new*.`[[ArrayBufferByteLength]]` < *newLen*, throw a **TypeError** exception.
20. Let *fromBuf* be *O*.`[[ArrayBufferData]]`.
21. Let *toBuf* be *new*.`[[ArrayBufferData]]`.
22. Perform [CopyDataBlockBytes](#)(*toBuf*, 0, *fromBuf*, *first*, *newLen*).
23. Return *new*.

#### 25.2.4.4 `SharedArrayBuffer.prototype [ @@toStringTag ]`

The initial value of the `@@toStringTag` property is the String value `"SharedArrayBuffer"`.

This property has the attributes { `[[Writable]]`: **false**, `[[Enumerable]]`: **false**, `[[Configurable]]`: **true** }.

## 25.2.5 Properties of SharedArrayBuffer Instances

SharedArrayBuffer instances inherit properties from the [SharedArrayBuffer prototype object](#). SharedArrayBuffer instances each have an `[[ArrayBufferData]]` internal slot and an `[[ArrayBufferByteLength]]` internal slot.

NOTE SharedArrayBuffer instances, unlike ArrayBuffer instances, are never detached.

## 25.3 DataView Objects

### 25.3.1 Abstract Operations For DataView Objects

#### 25.3.1.1 GetViewValue ( *view*, *requestIndex*, *isLittleEndian*, *type* )

The abstract operation `GetViewValue` takes arguments *view* (an ECMAScript language value), *requestIndex* (an ECMAScript language value), *isLittleEndian* (an ECMAScript language value), and *type* (a TypedArray element type) and returns either a normal completion containing either a Number or a BigInt, or a throw completion. It is used by functions on DataView instances to retrieve values from the view's buffer. It performs the following steps when called:

1. Perform ? [RequireInternalSlot](#)(*view*, `[[DataView]]`).
2. **Assert**: *view* has a `[[ViewedArrayBuffer]]` internal slot.
3. Let *getIndex* be ? [ToIndex](#)(*requestIndex*).
4. Set *isLittleEndian* to [ToBoolean](#)(*isLittleEndian*).
5. Let *buffer* be *view*.`[[ViewedArrayBuffer]]`.
6. If [IsDetachedBuffer](#)(*buffer*) is **true**, throw a **TypeError** exception.
7. Let *viewOffset* be *view*.`[[ByteOffset]]`.
8. Let *viewSize* be *view*.`[[ByteLength]]`.
9. Let *elementSize* be the Element Size value specified in [Table 68](#) for Element Type *type*.
10. If *getIndex* + *elementSize* > *viewSize*, throw a **RangeError** exception.
11. Let *bufferIndex* be *getIndex* + *viewOffset*.
12. Return [GetValueFromBuffer](#)(*buffer*, *bufferIndex*, *type*, **false**, `Unordered`, *isLittleEndian*).

#### 25.3.1.2 SetViewValue ( *view*, *requestIndex*, *isLittleEndian*, *type*, *value* )

The abstract operation `SetViewValue` takes arguments *view* (an ECMAScript language value), *requestIndex* (an ECMAScript language value), *isLittleEndian* (an ECMAScript language value), *type* (a TypedArray element type), and *value* (an ECMAScript language value) and returns either a normal completion containing **undefined** or a throw completion. It is used by functions on DataView instances to store values into the view's buffer. It performs the following steps when called:

1. Perform ? [RequireInternalSlot](#)(*view*, `[[DataView]]`).
2. **Assert**: *view* has a `[[ViewedArrayBuffer]]` internal slot.
3. Let *getIndex* be ? [ToIndex](#)(*requestIndex*).
4. If [IsBigIntElementType](#)(*type*) is **true**, let *numberValue* be ? [ToBigInt](#)(*value*).
5. Otherwise, let *numberValue* be ? [ToNumber](#)(*value*).
6. Set *isLittleEndian* to [ToBoolean](#)(*isLittleEndian*).
7. Let *buffer* be *view*.`[[ViewedArrayBuffer]]`.
8. If [IsDetachedBuffer](#)(*buffer*) is **true**, throw a **TypeError** exception.

9. Let *viewOffset* be *view*.[[ByteOffset]].
10. Let *viewSize* be *view*.[[ByteLength]].
11. Let *elementSize* be the Element Size value specified in Table 68 for Element Type *type*.
12. If *getIndex* + *elementSize* > *viewSize*, throw a **RangeError** exception.
13. Let *bufferIndex* be *getIndex* + *viewOffset*.
14. Perform *SetValueInBuffer*(*buffer*, *bufferIndex*, *type*, *numberValue*, **false**, Unordered, *isLittleEndian*).
15. Return **undefined**.

## 25.3.2 The DataView Constructor

The DataView [constructor](#):

- is `%DataView%`.
- is the initial value of the **"DataView"** property of the [global object](#).
- creates and initializes a new DataView when called as a [constructor](#).
- is not intended to be called as a function and will throw an exception when called in that manner.
- may be used as the value of an **extends** clause of a class definition. Subclass [constructors](#) that intend to inherit the specified DataView behaviour must include a **super** call to the DataView [constructor](#) to create and initialize subclass instances with the internal state necessary to support the **DataView.prototype** built-in methods.

### 25.3.2.1 DataView ( *buffer* [ , *byteOffset* [ , *byteLength* ] ] )

This function performs the following steps when called:

1. If *NewTarget* is **undefined**, throw a **TypeError** exception.
2. Perform ? [RequireInternalSlot](#)(*buffer*, [[ArrayBufferData]]).
3. Let *offset* be ? [ToIndex](#)(*byteOffset*).
4. If [IsDetachedBuffer](#)(*buffer*) is **true**, throw a **TypeError** exception.
5. Let *bufferByteLength* be *buffer*.[[ArrayBufferByteLength]].
6. If *offset* > *bufferByteLength*, throw a **RangeError** exception.
7. If *byteLength* is **undefined**, then
  - a. Let *viewByteLength* be *bufferByteLength* - *offset*.
8. Else,
  - a. Let *viewByteLength* be ? [ToIndex](#)(*byteLength*).
  - b. If *offset* + *viewByteLength* > *bufferByteLength*, throw a **RangeError** exception.
9. Let *O* be ? [OrdinaryCreateFromConstructor](#)(*NewTarget*, **"%DataView.prototype%"**, « [[DataView]], [[ViewedArrayBuffer]], [[ByteLength]], [[ByteOffset]] »).
10. If [IsDetachedBuffer](#)(*buffer*) is **true**, throw a **TypeError** exception.
11. Set *O*.[[ViewedArrayBuffer]] to *buffer*.
12. Set *O*.[[ByteLength]] to *viewByteLength*.
13. Set *O*.[[ByteOffset]] to *offset*.
14. Return *O*.

## 25.3.3 Properties of the DataView Constructor

The DataView [constructor](#):

- has a [[Prototype]] internal slot whose value is `%Function.prototype%`.
- has the following properties:



### 25.3.3.1 DataView.prototype

The initial value of `DataView.prototype` is the [DataView prototype object](#).

This property has the attributes { `[[Writable]]`: **false**, `[[Enumerable]]`: **false**, `[[Configurable]]`: **false** }.

### 25.3.4 Properties of the DataView Prototype Object

The *DataView prototype object*:

- is `%DataView.prototype%`.
- has a `[[Prototype]]` internal slot whose value is `%Object.prototype%`.
- is an [ordinary object](#).
- does not have a `[[DataView]]`, `[[ViewedArrayBuffer]]`, `[[ByteLength]]`, or `[[ByteOffset]]` internal slot.

#### 25.3.4.1 get DataView.prototype.buffer

`DataView.prototype.buffer` is an [accessor property](#) whose set accessor function is **undefined**. Its get accessor function performs the following steps when called:

1. Let `O` be the **this** value.
2. Perform ? [RequireInternalSlot](#)(`O`, `[[DataView]]`).
3. **Assert**: `O` has a `[[ViewedArrayBuffer]]` internal slot.
4. Let `buffer` be `O`.`[[ViewedArrayBuffer]]`.
5. Return `buffer`.

#### 25.3.4.2 get DataView.prototype.byteLength

`DataView.prototype.byteLength` is an [accessor property](#) whose set accessor function is **undefined**. Its get accessor function performs the following steps when called:

1. Let `O` be the **this** value.
2. Perform ? [RequireInternalSlot](#)(`O`, `[[DataView]]`).
3. **Assert**: `O` has a `[[ViewedArrayBuffer]]` internal slot.
4. Let `buffer` be `O`.`[[ViewedArrayBuffer]]`.
5. If [IsDetachedBuffer](#)(`buffer`) is **true**, throw a **TypeError** exception.
6. Let `size` be `O`.`[[ByteLength]]`.
7. Return  $\mathbb{F}$ (`size`).

#### 25.3.4.3 get DataView.prototype.byteOffset

`DataView.prototype.byteOffset` is an [accessor property](#) whose set accessor function is **undefined**. Its get accessor function performs the following steps when called:

1. Let `O` be the **this** value.
2. Perform ? [RequireInternalSlot](#)(`O`, `[[DataView]]`).
3. **Assert**: `O` has a `[[ViewedArrayBuffer]]` internal slot.
4. Let `buffer` be `O`.`[[ViewedArrayBuffer]]`.
5. If [IsDetachedBuffer](#)(`buffer`) is **true**, throw a **TypeError** exception.
6. Let `offset` be `O`.`[[ByteOffset]]`.
7. Return  $\mathbb{F}$ (`offset`).

#### 25.3.4.4 DataView.prototype.constructor

The initial value of `DataView.prototype.constructor` is `%DataView%`.

#### 25.3.4.5 DataView.prototype.getBigInt64 ( *byteOffset* [ , *littleEndian* ] )

This method performs the following steps when called:

1. Let *v* be the **this** value.
2. Return ? `GetViewValue(v, byteOffset, littleEndian, BigInt64)`.

#### 25.3.4.6 DataView.prototype.getBigUint64 ( *byteOffset* [ , *littleEndian* ] )

This method performs the following steps when called:

1. Let *v* be the **this** value.
2. Return ? `GetViewValue(v, byteOffset, littleEndian, BigUint64)`.

#### 25.3.4.7 DataView.prototype.getFloat32 ( *byteOffset* [ , *littleEndian* ] )

This method performs the following steps when called:

1. Let *v* be the **this** value.
2. If *littleEndian* is not present, set *littleEndian* to **false**.
3. Return ? `GetViewValue(v, byteOffset, littleEndian, Float32)`.

#### 25.3.4.8 DataView.prototype.getFloat64 ( *byteOffset* [ , *littleEndian* ] )

This method performs the following steps when called:

1. Let *v* be the **this** value.
2. If *littleEndian* is not present, set *littleEndian* to **false**.
3. Return ? `GetViewValue(v, byteOffset, littleEndian, Float64)`.

#### 25.3.4.9 DataView.prototype.getInt8 ( *byteOffset* )

This method performs the following steps when called:

1. Let *v* be the **this** value.
2. Return ? `GetViewValue(v, byteOffset, true, Int8)`.

#### 25.3.4.10 DataView.prototype.getInt16 ( *byteOffset* [ , *littleEndian* ] )

This method performs the following steps when called:

1. Let *v* be the **this** value.
2. If *littleEndian* is not present, set *littleEndian* to **false**.
3. Return ? `GetViewValue(v, byteOffset, littleEndian, Int16)`.

#### 25.3.4.11 DataView.prototype.getInt32 ( *byteOffset* [ , *littleEndian* ] )

This method performs the following steps when called:

1. Let *v* be the **this** value.
2. If *littleEndian* is not present, set *littleEndian* to **false**.
3. Return ? [GetViewValue](#)(*v*, *byteOffset*, *littleEndian*, Int32).

#### 25.3.4.12 DataView.prototype.getUint8 ( *byteOffset* )

This method performs the following steps when called:

1. Let *v* be the **this** value.
2. Return ? [GetViewValue](#)(*v*, *byteOffset*, **true**, Uint8).

#### 25.3.4.13 DataView.prototype.getUint16 ( *byteOffset* [ , *littleEndian* ] )

This method performs the following steps when called:

1. Let *v* be the **this** value.
2. If *littleEndian* is not present, set *littleEndian* to **false**.
3. Return ? [GetViewValue](#)(*v*, *byteOffset*, *littleEndian*, Uint16).

#### 25.3.4.14 DataView.prototype.getUint32 ( *byteOffset* [ , *littleEndian* ] )

This method performs the following steps when called:

1. Let *v* be the **this** value.
2. If *littleEndian* is not present, set *littleEndian* to **false**.
3. Return ? [GetViewValue](#)(*v*, *byteOffset*, *littleEndian*, Uint32).

#### 25.3.4.15 DataView.prototype.setBigInt64 ( *byteOffset*, *value* [ , *littleEndian* ] )

This method performs the following steps when called:

1. Let *v* be the **this** value.
2. Return ? [SetViewValue](#)(*v*, *byteOffset*, *littleEndian*, BigInt64, *value*).

#### 25.3.4.16 DataView.prototype.setBigUint64 ( *byteOffset*, *value* [ , *littleEndian* ] )

This method performs the following steps when called:

1. Let *v* be the **this** value.
2. Return ? [SetViewValue](#)(*v*, *byteOffset*, *littleEndian*, BigUint64, *value*).

#### 25.3.4.17 DataView.prototype.setFloat32 ( *byteOffset*, *value* [ , *littleEndian* ] )

This method performs the following steps when called:

1. Let *v* be the **this** value.

2. If *littleEndian* is not present, set *littleEndian* to **false**.
3. Return ? *SetViewValue*(*v*, *byteOffset*, *littleEndian*, Float32, *value*).

#### 25.3.4.18 *DataView.prototype.setFloat64* ( *byteOffset*, *value* [ , *littleEndian* ] )

This method performs the following steps when called:

1. Let *v* be the **this** value.
2. If *littleEndian* is not present, set *littleEndian* to **false**.
3. Return ? *SetViewValue*(*v*, *byteOffset*, *littleEndian*, Float64, *value*).

#### 25.3.4.19 *DataView.prototype.setInt8* ( *byteOffset*, *value* )

This method performs the following steps when called:

1. Let *v* be the **this** value.
2. Return ? *SetViewValue*(*v*, *byteOffset*, **true**, Int8, *value*).

#### 25.3.4.20 *DataView.prototype.setInt16* ( *byteOffset*, *value* [ , *littleEndian* ] )

This method performs the following steps when called:

1. Let *v* be the **this** value.
2. If *littleEndian* is not present, set *littleEndian* to **false**.
3. Return ? *SetViewValue*(*v*, *byteOffset*, *littleEndian*, Int16, *value*).

#### 25.3.4.21 *DataView.prototype.setInt32* ( *byteOffset*, *value* [ , *littleEndian* ] )

This method performs the following steps when called:

1. Let *v* be the **this** value.
2. If *littleEndian* is not present, set *littleEndian* to **false**.
3. Return ? *SetViewValue*(*v*, *byteOffset*, *littleEndian*, Int32, *value*).

#### 25.3.4.22 *DataView.prototype.setUint8* ( *byteOffset*, *value* )

This method performs the following steps when called:

1. Let *v* be the **this** value.
2. Return ? *SetViewValue*(*v*, *byteOffset*, **true**, Uint8, *value*).

#### 25.3.4.23 *DataView.prototype.setUint16* ( *byteOffset*, *value* [ , *littleEndian* ] )

This method performs the following steps when called:

1. Let *v* be the **this** value.
2. If *littleEndian* is not present, set *littleEndian* to **false**.
3. Return ? *SetViewValue*(*v*, *byteOffset*, *littleEndian*, Uint16, *value*).

#### 25.3.4.24 DataView.prototype.setUint32 ( *byteOffset*, *value* [ , *littleEndian* ] )

This method performs the following steps when called:

1. Let *v* be the **this** value.
2. If *littleEndian* is not present, set *littleEndian* to **false**.
3. Return ? [SetViewValue](#)(*v*, *byteOffset*, *littleEndian*, Uint32, *value*).

#### 25.3.4.25 DataView.prototype [ @@toStringTag ]

The initial value of the @@toStringTag property is the String value **"DataView"**.

This property has the attributes { [[Writable]]: **false**, [[Enumerable]]: **false**, [[Configurable]]: **true** }.

### 25.3.5 Properties of DataView Instances

DataView instances are [ordinary objects](#) that inherit properties from the [DataView prototype object](#). DataView instances each have [[DataView]], [[ViewedArrayBuffer]], [[ByteLength]], and [[ByteOffset]] internal slots.

**NOTE** The value of the [[DataView]] internal slot is not used within this specification. The simple presence of that internal slot is used within the specification to identify objects created using the [DataView constructor](#).

## 25.4 The Atomics Object

The Atomics object:

- is [%Atomics%](#).
- is the initial value of the **"Atomics"** property of the [global object](#).
- is an [ordinary object](#).
- has a [[Prototype]] internal slot whose value is [%Object.prototype%](#).
- does not have a [[Construct]] internal method; it cannot be used as a [constructor](#) with the **new** operator.
- does not have a [[Call]] internal method; it cannot be invoked as a function.

The Atomics object provides functions that operate indivisibly (atomically) on shared memory array cells as well as functions that let [agents](#) wait for and dispatch primitive events. When used with discipline, the Atomics functions allow multi-[agent](#) programs that communicate through shared memory to execute in a well-understood order even on parallel CPUs. The rules that govern shared-memory communication are provided by the [memory model](#), defined below.

**NOTE** For informative guidelines for programming and implementing shared memory in ECMAScript, please see the notes at the end of the [memory model](#) section.

### 25.4.1 WaiterList Objects

A *WaiterList* is a semantic object that contains an ordered list of [agent signifiers](#) for those [agents](#) that are waiting on a location (*block*, *i*) in shared memory; *block* is a [Shared Data Block](#) and *i* a byte offset into the memory of *block*. A WaiterList object also optionally contains a [Synchronize event](#) denoting the previous leaving of its critical section.

Initially a WaiterList object has an empty list and no [Synchronize event](#).

The **agent cluster** has a store of WaiterList objects; the store is indexed by  $(block, i)$ . WaiterLists are **agent-independent**: a lookup in the store of WaiterLists by  $(block, i)$  will result in the same WaiterList object in any **agent** in the **agent cluster**.

Each WaiterList has a *critical section* that controls exclusive access to that WaiterList during evaluation. Only a single **agent** may enter a WaiterList's critical section at one time. Entering and leaving a WaiterList's critical section is controlled by the **abstract operations** `EnterCriticalSection` and `LeaveCriticalSection`. Operations on a WaiterList—adding and removing waiting **agents**, traversing the list of **agents**, suspending and notifying **agents** on the list, setting and retrieving the **Synchronize event**—may only be performed by **agents** that have entered the WaiterList's critical section.

## 25.4.2 Abstract Operations for Atomics

### 25.4.2.1 ValidateIntegerTypedArray ( *typedArray* [ , *waitable* ] )

The abstract operation `ValidateIntegerTypedArray` takes argument *typedArray* (an **ECMAScript language value**) and optional argument *waitable* (a Boolean) and returns either a **normal completion containing** either an `ArrayBuffer` or a `SharedArrayBuffer`, or a **throw completion**. It performs the following steps when called:

1. If *waitable* is not present, set *waitable* to **false**.
2. Perform ? `ValidateTypedArray(typedArray)`.
3. Let *buffer* be `typedArray.[[ViewedArrayBuffer]]`.
4. If *waitable* is **true**, then
  - a. If `typedArray.[[TypedArrayName]]` is neither **"Int32Array"** nor **"BigInt64Array"**, throw a **TypeError** exception.
5. Else,
  - a. Let *type* be `TypedArrayElementType(typedArray)`.
  - b. If `IsUnclampedIntegerElementType(type)` is **false** and `IsBigIntElementType(type)` is **false**, throw a **TypeError** exception.
6. Return *buffer*.

### 25.4.2.2 ValidateAtomicAccess ( *typedArray*, *requestIndex* )

The abstract operation `ValidateAtomicAccess` takes arguments *typedArray* (a `TypedArray`) and *requestIndex* (an **ECMAScript language value**) and returns either a **normal completion containing** an **integer** or a **throw completion**. It performs the following steps when called:

1. Let *length* be `typedArray.[[ArrayLength]]`.
2. Let *accessIndex* be ? `ToIndex(requestIndex)`.
3. **Assert**: *accessIndex*  $\geq 0$ .
4. If *accessIndex*  $\geq$  *length*, throw a **RangeError** exception.
5. Let *elementSize* be `TypedArrayElementSize(typedArray)`.
6. Let *offset* be `typedArray.[[ByteOffset]]`.
7. Return  $(accessIndex \times elementSize) + offset$ .

### 25.4.2.3 GetWaiterList ( *block*, *i* )

The abstract operation `GetWaiterList` takes arguments *block* (a **Shared Data Block**) and *i* (a non-negative **integer** that is evenly divisible by 4) and returns a **WaiterList**. It performs the following steps when called:

1. **Assert**: *i* and *i* + 3 are valid byte offsets within the memory of *block*.
2. Return the **WaiterList** that is referenced by the pair  $(block, i)$ .

#### 25.4.2.4 EnterCriticalSection ( *WL* )

The abstract operation EnterCriticalSection takes argument *WL* (a WaiterList) and returns unused. It performs the following steps when called:

1. **Assert:** The surrounding agent is not in the critical section for any WaiterList.
2. Wait until no agent is in the critical section for *WL*, then enter the critical section for *WL* (without allowing any other agent to enter).
3. If *WL* has a Synchronize event, then
  - a. NOTE: A *WL* whose critical section has been entered at least once has a Synchronize event set by LeaveCriticalSection.
  - b. Let *execution* be the [[CandidateExecution]] field of the surrounding agent's Agent Record.
  - c. Let *eventsRecord* be the Agent Events Record of *execution*.[[EventsRecords]] whose [[AgentSignifier]] is AgentSignifier().
  - d. Let *enterEvent* be a new Synchronize event.
  - e. Append *enterEvent* to *eventsRecord*.[[EventList]].
  - f. Let *leaveEvent* be the Synchronize event in *WL*.
  - g. Append (*leaveEvent*, *enterEvent*) to *eventsRecord*.[[AgentSynchronizesWith]].
4. Return unused.

EnterCriticalSection has *contention* when an agent attempting to enter the critical section must wait for another agent to leave it. When there is no contention, FIFO order of EnterCriticalSection calls is observable. When there is contention, an implementation may choose an arbitrary order but may not cause an agent to wait indefinitely.

#### 25.4.2.5 LeaveCriticalSection ( *WL* )

The abstract operation LeaveCriticalSection takes argument *WL* (a WaiterList) and returns unused. It performs the following steps when called:

1. **Assert:** The surrounding agent is in the critical section for *WL*.
2. Let *execution* be the [[CandidateExecution]] field of the surrounding agent's Agent Record.
3. Let *eventsRecord* be the Agent Events Record of *execution*.[[EventsRecords]] whose [[AgentSignifier]] is AgentSignifier().
4. Let *leaveEvent* be a new Synchronize event.
5. Append *leaveEvent* to *eventsRecord*.[[EventList]].
6. Set the Synchronize event in *WL* to *leaveEvent*.
7. Leave the critical section for *WL*.
8. Return unused.

#### 25.4.2.6 AddWaiter ( *WL*, *W* )

The abstract operation AddWaiter takes arguments *WL* (a WaiterList) and *W* (an agent signifier) and returns unused. It performs the following steps when called:

1. **Assert:** The surrounding agent is in the critical section for *WL*.
2. **Assert:** *W* is not on the list of waiters in any WaiterList.
3. Append *W* to *WL*.
4. Return unused.

### 25.4.2.7 RemoveWaiter ( *WL*, *W* )

The abstract operation RemoveWaiter takes arguments *WL* (a WaiterList) and *W* (an agent signifier) and returns unused. It performs the following steps when called:

1. **Assert:** The surrounding agent is in the critical section for *WL*.
2. **Assert:** *W* is on the list of waiters in *WL*.
3. Remove *W* from the list of waiters in *WL*.
4. Return unused.

### 25.4.2.8 RemoveWaiters ( *WL*, *c* )

The abstract operation RemoveWaiters takes arguments *WL* (a WaiterList) and *c* (a non-negative integer or  $+\infty$ ) and returns a List of agent signifiers. It performs the following steps when called:

1. **Assert:** The surrounding agent is in the critical section for *WL*.
2. Let *S* be a reference to the list of waiters in *WL*.
3. Let *len* be the number of elements in *S*.
4. Let *n* be  $\min(c, len)$ .
5. Let *L* be a List whose elements are the first *n* elements of *S*.
6. Remove the first *n* elements of *S*.
7. Return *L*.

### 25.4.2.9 SuspendAgent ( *WL*, *W*, *minimumTimeout* )

The abstract operation SuspendAgent takes arguments *WL* (a WaiterList), *W* (an agent signifier), and *minimumTimeout* (a non-negative extended mathematical value) and returns a Boolean. It performs the following steps when called:

1. **Assert:** The surrounding agent is in the critical section for *WL*.
2. **Assert:** *W* is AgentSignifier().
3. **Assert:** *W* is on the list of waiters in *WL*.
4. **Assert:** AgentCanSuspend() is **true**.
5. Let *additionalTimeout* be an implementation-defined non-negative mathematical value.
6. Let *timeout* be  $minimumTimeout + additionalTimeout$ .
7. **NOTE:** When *minimumTimeout* is  $+\infty$ , *timeout* is also  $+\infty$  and the following step can terminate only by another agent calling NotifyWaiter.
8. Perform LeaveCriticalSection(*WL*) and suspend *W* for up to *timeout* milliseconds, performing the combined operation in such a way that a notification that arrives after the critical section is exited but before the suspension takes effect is not lost. *W* can wake from suspension either because the timeout expired or because it was notified explicitly by another agent calling NotifyWaiter with arguments *WL* and *W*, and not for any other reasons at all.
9. Perform EnterCriticalSection(*WL*).
10. If *W* was notified explicitly by another agent calling NotifyWaiter with arguments *WL* and *W*, return **true**.
11. Return **false**.

**NOTE** *additionalTimeout* allows implementations to pad timeouts as necessary, such as for reducing power consumption or coarsening timer resolution to mitigate timing attacks. This value may differ from call to call of SuspendAgent.



### 25.4.2.10 NotifyWaiter ( *WL*, *W* )

The abstract operation NotifyWaiter takes arguments *WL* (a [WaiterList](#)) and *W* (an [agent signifier](#)) and returns unused. It performs the following steps when called:

1. **Assert**: The [surrounding agent](#) is in the [critical section](#) for *WL*.
2. Notify the [agent](#) *W*.
3. Return unused.

**NOTE** The embedding may delay notifying *W*, e.g. for resource management reasons, but *W* must eventually be notified in order to guarantee forward progress.

### 25.4.2.11 AtomicReadModifyWrite ( *typedArray*, *index*, *value*, *op* )

The abstract operation AtomicReadModifyWrite takes arguments *typedArray* (an [ECMAScript language value](#)), *index* (an [ECMAScript language value](#)), *value* (an [ECMAScript language value](#)), and *op* (a [read-modify-write modification function](#)) and returns either a [normal completion](#) containing either a [Number](#) or a [BigInt](#), or a [throw completion](#). *op* takes two [List of byte values](#) arguments and returns a [List of byte values](#). This operation atomically loads a value, combines it with another value, and stores the result of the combination. It returns the loaded value. It performs the following steps when called:

1. Let *buffer* be ? [ValidateIntegerTypedArray](#)(*typedArray*).
2. Let *indexedPosition* be ? [ValidateAtomicAccess](#)(*typedArray*, *index*).
3. If *typedArray*.[[ContentTypes]] is [BigInt](#), let *v* be ? [ToBigInt](#)(*value*).
4. Otherwise, let *v* be  $\mathbb{F}$ (? [ToIntegerOrInfinity](#)(*value*)).
5. If [IsDetachedBuffer](#)(*buffer*) is **true**, throw a **TypeError** exception.
6. **NOTE**: The above check is not redundant with the check in [ValidateIntegerTypedArray](#) because the call to [ToBigInt](#) or [ToIntegerOrInfinity](#) on the preceding lines can have arbitrary side effects, which could cause the buffer to become detached.
7. Let *elementType* be [TypedArrayElementType](#)(*typedArray*).
8. Return [GetModifySetValueInBuffer](#)(*buffer*, *indexedPosition*, *elementType*, *v*, *op*).

### 25.4.2.12 ByteListBitwiseOp ( *op*, *xBytes*, *yBytes* )

The abstract operation ByteListBitwiseOp takes arguments *op* ([&](#), [^](#), or [|](#)), *xBytes* (a [List of byte values](#)), and *yBytes* (a [List of byte values](#)) and returns a [List of byte values](#). The operation atomically performs a bitwise operation on all [byte values](#) of the arguments and returns a [List of byte values](#). It performs the following steps when called:

1. **Assert**: *xBytes* and *yBytes* have the same number of elements.
2. Let *result* be a new empty [List](#).
3. Let *i* be 0.
4. For each element *xByte* of *xBytes*, do
  - a. Let *yByte* be *yBytes*[*i*].
  - b. If *op* is [&](#), let *resultByte* be the result of applying the bitwise AND operation to *xByte* and *yByte*.
  - c. Else if *op* is [^](#), let *resultByte* be the result of applying the bitwise exclusive OR (XOR) operation to *xByte* and *yByte*.
  - d. Else, *op* is [|](#). Let *resultByte* be the result of applying the bitwise inclusive OR operation to *xByte* and *yByte*.
  - e. Set *i* to *i* + 1.
  - f. Append *resultByte* to *result*.

5. Return *result*.

### 25.4.2.13 ByteListEqual ( *xBytes*, *yBytes* )

The abstract operation ByteListEqual takes arguments *xBytes* (a List of byte values) and *yBytes* (a List of byte values) and returns a Boolean. It performs the following steps when called:

1. If *xBytes* and *yBytes* do not have the same number of elements, return **false**.
2. Let *i* be 0.
3. For each element *xByte* of *xBytes*, do
  - a. Let *yByte* be *yBytes*[*i*].
  - b. If *xByte* ≠ *yByte*, return **false**.
  - c. Set *i* to *i* + 1.
4. Return **true**.

### 25.4.3 Atomics.add ( *typedArray*, *index*, *value* )

This function performs the following steps when called:

1. Let *type* be TypedArrayType(*typedArray*).
2. Let *isLittleEndian* be the value of the [[LittleEndian]] field of the surrounding agent's Agent Record.
3. Let *add* be a new read-modify-write modification function with parameters (*xBytes*, *yBytes*) that captures *type* and *isLittleEndian* and performs the following steps atomically when called:
  - a. Let *x* be RawBytesToNumeric(*type*, *xBytes*, *isLittleEndian*).
  - b. Let *y* be RawBytesToNumeric(*type*, *yBytes*, *isLittleEndian*).
  - c. If *x* is a Number, then
    - i. Let *sum* be Number::add(*x*, *y*).
  - d. Else,
    - i. Assert: *x* is a BigInt.
    - ii. Let *sum* be BigInt::add(*x*, *y*).
  - e. Let *sumBytes* be NumericToRawBytes(*type*, *sum*, *isLittleEndian*).
  - f. Assert: *sumBytes*, *xBytes*, and *yBytes* have the same number of elements.
  - g. Return *sumBytes*.
4. Return ? AtomicReadModifyWrite(*typedArray*, *index*, *value*, *add*).

### 25.4.4 Atomics.and ( *typedArray*, *index*, *value* )

This function performs the following steps when called:

1. Let *and* be a new read-modify-write modification function with parameters (*xBytes*, *yBytes*) that captures nothing and performs the following steps atomically when called:
  - a. Return ByteListBitwiseOp(&, *xBytes*, *yBytes*).
2. Return ? AtomicReadModifyWrite(*typedArray*, *index*, *value*, *and*).

### 25.4.5 Atomics.compareExchange ( *typedArray*, *index*, *expectedValue*, *replacementValue* )

This function performs the following steps when called:

1. Let *buffer* be ? ValidateIntegerTypedArray(*typedArray*).
2. Let *block* be *buffer*.[[ArrayBufferData]].

3. Let *indexedPosition* be ? *ValidateAtomicAccess*(*typedArray*, *index*).
4. If *typedArray*.[[ContentType]] is BigInt, then
  - a. Let *expected* be ? *ToBigInt*(*expectedValue*).
  - b. Let *replacement* be ? *ToBigInt*(*replacementValue*).
5. Else,
  - a. Let *expected* be  $\mathbb{F}$ (? *ToIntegerOrInfinity*(*expectedValue*)).
  - b. Let *replacement* be  $\mathbb{F}$ (? *ToIntegerOrInfinity*(*replacementValue*)).
6. If *IsDetachedBuffer*(*buffer*) is **true**, throw a **TypeError** exception.
7. NOTE: The above check is not redundant with the check in *ValidateIntegerTypedArray* because the call to *ToBigInt* or *ToIntegerOrInfinity* on the preceding lines can have arbitrary side effects, which could cause the buffer to become detached.
8. Let *elementType* be *TypedArrayElementType*(*typedArray*).
9. Let *elementSize* be *TypedArrayElementSize*(*typedArray*).
10. Let *isLittleEndian* be the value of the [[LittleEndian]] field of the surrounding agent's Agent Record.
11. Let *expectedBytes* be *NumericToRawBytes*(*elementType*, *expected*, *isLittleEndian*).
12. Let *replacementBytes* be *NumericToRawBytes*(*elementType*, *replacement*, *isLittleEndian*).
13. If *IsSharedArrayBuffer*(*buffer*) is **true**, then
  - a. Let *execution* be the [[CandidateExecution]] field of the surrounding agent's Agent Record.
  - b. Let *eventsRecord* be the Agent Events Record of *execution*.[[EventsRecords]] whose [[AgentSignifier]] is *AgentSignifier*().
  - c. Let *rawBytesRead* be a List of length *elementSize* whose elements are nondeterministically chosen byte values.
  - d. NOTE: In implementations, *rawBytesRead* is the result of a load-link, of a load-exclusive, or of an operand of a read-modify-write instruction on the underlying hardware. The nondeterminism is a semantic prescription of the memory model to describe observable behaviour of hardware with weak consistency.
  - e. NOTE: The comparison of the expected value and the read value is performed outside of the *read-modify-write modification function* to avoid needlessly strong synchronization when the expected value is not equal to the read value.
  - f. If *ByteListEqual*(*rawBytesRead*, *expectedBytes*) is **true**, then
    - i. Let *second* be a new *read-modify-write modification function* with parameters (*oldBytes*, *newBytes*) that captures nothing and performs the following steps atomically when called:
      1. Return *newBytes*.
    - ii. Let *event* be *ReadModifyWriteSharedMemory* { [[Order]]: SeqCst, [[NoTear]]: **true**, [[Block]]: *block*, [[ByteIndex]]: *indexedPosition*, [[ElementSize]]: *elementSize*, [[Payload]]: *replacementBytes*, [[ModifyOp]]: *second* }.
  - g. Else,
    - i. Let *event* be *ReadSharedMemory* { [[Order]]: SeqCst, [[NoTear]]: **true**, [[Block]]: *block*, [[ByteIndex]]: *indexedPosition*, [[ElementSize]]: *elementSize* }.
  - h. Append *event* to *eventsRecord*.[[EventList]].
  - i. Append Chosen Value Record { [[Event]]: *event*, [[ChosenValue]]: *rawBytesRead* } to *execution*.[[ChosenValues]].
14. Else,
  - a. Let *rawBytesRead* be a List of length *elementSize* whose elements are the sequence of *elementSize* bytes starting with *block*[*indexedPosition*].
  - b. If *ByteListEqual*(*rawBytesRead*, *expectedBytes*) is **true**, then
    - i. Store the individual bytes of *replacementBytes* into *block*, starting at *block*[*indexedPosition*].
15. Return *RawBytesToNumeric*(*elementType*, *rawBytesRead*, *isLittleEndian*).

### 25.4.6 `Atomics.exchange` ( *typedArray*, *index*, *value* )

This function performs the following steps when called:

1. Let *second* be a new `read-modify-write` modification function with parameters (*oldBytes*, *newBytes*) that captures nothing and performs the following steps atomically when called:
  - a. Return *newBytes*.
2. Return ? `AtomicReadModifyWrite`(*typedArray*, *index*, *value*, *second*).

### 25.4.7 `Atomics.isLockFree` ( *size* )

This function performs the following steps when called:

1. Let *n* be ? `ToIntegerOrInfinity`(*size*).
2. Let *AR* be the `Agent Record` of the `surrounding agent`.
3. If *n* = 1, return *AR*.[[`IsLockFree1`]].
4. If *n* = 2, return *AR*.[[`IsLockFree2`]].
5. If *n* = 4, return **true**.
6. If *n* = 8, return *AR*.[[`IsLockFree8`]].
7. Return **false**.

**NOTE** This function is an optimization primitive. The intuition is that if the atomic step of an atomic primitive (`compareExchange`, `load`, `store`, `add`, `sub`, `and`, `or`, `xor`, or `exchange`) on a datum of size *n* bytes will be performed without the `surrounding agent` acquiring a lock outside the *n* bytes comprising the datum, then `Atomics.isLockFree`(*n*) will return **true**. High-performance algorithms will use this function to determine whether to use locks or atomic operations in `critical sections`. If an atomic primitive is not lock-free then it is often more efficient for an algorithm to provide its own locking.

`Atomics.isLockFree`(4) always returns **true** as that can be supported on all known relevant hardware. Being able to assume this will generally simplify programs.

Regardless of the value returned by this function, all atomic operations are guaranteed to be atomic. For example, they will never have a visible operation take place in the middle of the operation (e.g., "tearing").

### 25.4.8 `Atomics.load` ( *typedArray*, *index* )

This function performs the following steps when called:

1. Let *buffer* be ? `ValidateIntegerTypedArray`(*typedArray*).
2. Let *indexedPosition* be ? `ValidateAtomicAccess`(*typedArray*, *index*).
3. If `IsDetachedBuffer`(*buffer*) is **true**, throw a **TypeError** exception.
4. NOTE: The above check is not redundant with the check in `ValidateIntegerTypedArray` because the call to `ValidateAtomicAccess` on the preceding line can have arbitrary side effects, which could cause the buffer to become detached.
5. Let *elementType* be `TypedArrayElementType`(*typedArray*).
6. Return `GetValueFromBuffer`(*buffer*, *indexedPosition*, *elementType*, **true**, `SeqCst`).

### 25.4.9 **Atomics.or** ( *typedArray*, *index*, *value* )

This function performs the following steps when called:

1. Let *or* be a new [read-modify-write modification function](#) with parameters (*xBytes*, *yBytes*) that captures nothing and performs the following steps atomically when called:
  - a. Return [ByteListBitwiseOp](#)(*l*, *xBytes*, *yBytes*).
2. Return ? [AtomicReadModifyWrite](#)(*typedArray*, *index*, *value*, *or*).

### 25.4.10 **Atomics.store** ( *typedArray*, *index*, *value* )

This function performs the following steps when called:

1. Let *buffer* be ? [ValidateIntegerTypedArray](#)(*typedArray*).
2. Let *indexedPosition* be ? [ValidateAtomicAccess](#)(*typedArray*, *index*).
3. If *typedArray*.[[Contentype]] is [BigInt](#), let *v* be ? [ToBigInt](#)(*value*).
4. Otherwise, let *v* be [ℱ](#)(? [ToIntegerOrInfinity](#)(*value*)).
5. If [IsDetachedBuffer](#)(*buffer*) is **true**, throw a **TypeError** exception.
6. NOTE: The above check is not redundant with the check in [ValidateIntegerTypedArray](#) because the call to [ToBigInt](#) or [ToIntegerOrInfinity](#) on the preceding lines can have arbitrary side effects, which could cause the buffer to become detached.
7. Let *elementType* be [TypedArrayElementType](#)(*typedArray*).
8. Perform [SetValueInBuffer](#)(*buffer*, *indexedPosition*, *elementType*, *v*, **true**, [SeqCst](#)).
9. Return *v*.

### 25.4.11 **Atomics.sub** ( *typedArray*, *index*, *value* )

This function performs the following steps when called:

1. Let *type* be [TypedArrayElementType](#)(*typedArray*).
2. Let *isLittleEndian* be the value of the [[LittleEndian]] field of the [surrounding agent's Agent Record](#).
3. Let *subtract* be a new [read-modify-write modification function](#) with parameters (*xBytes*, *yBytes*) that captures *type* and *isLittleEndian* and performs the following steps atomically when called:
  - a. Let *x* be [RawBytesToNumeric](#)(*type*, *xBytes*, *isLittleEndian*).
  - b. Let *y* be [RawBytesToNumeric](#)(*type*, *yBytes*, *isLittleEndian*).
  - c. If *x* is a [Number](#), then
    - i. Let *difference* be [Number::subtract](#)(*x*, *y*).
  - d. Else,
    - i. **Assert**: *x* is a [BigInt](#).
    - ii. Let *difference* be [BigInt::subtract](#)(*x*, *y*).
  - e. Let *differenceBytes* be [NumericToRawBytes](#)(*type*, *difference*, *isLittleEndian*).
  - f. **Assert**: *differenceBytes*, *xBytes*, and *yBytes* have the same number of elements.
  - g. Return *differenceBytes*.
4. Return ? [AtomicReadModifyWrite](#)(*typedArray*, *index*, *value*, *subtract*).

### 25.4.12 **Atomics.wait** ( *typedArray*, *index*, *value*, *timeout* )

This function puts the [surrounding agent](#) in a wait queue and suspends it until notified or until the wait times out, returning a [String](#) differentiating those cases.

It performs the following steps when called:

1. Let *buffer* be ? `ValidateIntegerTypedArray(typedArray, true)`.
2. If `IsSharedArrayBuffer(buffer)` is **false**, throw a **TypeError** exception.
3. Let *indexedPosition* be ? `ValidateAtomicAccess(typedArray, index)`.
4. If `typedArray.[[TypedArrayName]]` is **"BigInt64Array"**, let *v* be ? `ToBigInt64(value)`.
5. Otherwise, let *v* be ? `ToInt32(value)`.
6. Let *q* be ? `ToNumber(timeout)`.
7. If *q* is either **NaN** or  $+\infty_{\mathbb{F}}$ , let *t* be  $+\infty$ ; else if *q* is  $-\infty_{\mathbb{F}}$ , let *t* be 0; else let *t* be  $\max(\mathbb{R}(q), 0)$ .
8. Let *B* be `AgentCanSuspend()`.
9. If *B* is **false**, throw a **TypeError** exception.
10. Let *block* be `buffer.[[ArrayBufferData]]`.
11. Let *WL* be `GetWaiterList(block, indexedPosition)`.
12. Perform `EnterCriticalSection(WL)`.
13. Let *elementType* be `TypedArrayElementType(typedArray)`.
14. Let *w* be `GetValueFromBuffer(buffer, indexedPosition, elementType, true, SeqCst)`.
15. If  $v \neq w$ , then
  - a. Perform `LeaveCriticalSection(WL)`.
  - b. Return **"not-equal"**.
16. Let *W* be `AgentSignifier()`.
17. Perform `AddWaiter(WL, W)`.
18. Let *notified* be `SuspendAgent(WL, W, t)`.
19. If *notified* is **true**, then
  - a. Assert: *W* is not on the list of waiters in *WL*.
20. Else,
  - a. Perform `RemoveWaiter(WL, W)`.
21. Perform `LeaveCriticalSection(WL)`.
22. If *notified* is **true**, return **"ok"**.
23. Return **"timed-out"**.

### 25.4.13 **Atomics.notify** ( *typedArray*, *index*, *count* )

This function notifies some **agents** that are sleeping in the wait queue.

It performs the following steps when called:

1. Let *buffer* be ? `ValidateIntegerTypedArray(typedArray, true)`.
2. Let *indexedPosition* be ? `ValidateAtomicAccess(typedArray, index)`.
3. If *count* is **undefined**, let *c* be  $+\infty$ .
4. Else,
  - a. Let *intCount* be ? `ToIntegerOrInfinity(count)`.
  - b. Let *c* be  $\max(\text{intCount}, 0)$ .
5. Let *block* be `buffer.[[ArrayBufferData]]`.
6. If `IsSharedArrayBuffer(buffer)` is **false**, return **+0<sub>F</sub>**.
7. Let *WL* be `GetWaiterList(block, indexedPosition)`.
8. Perform `EnterCriticalSection(WL)`.
9. Let *S* be `RemoveWaiters(WL, c)`.
10. For each element *W* of *S*, do
  - a. Perform `NotifyWaiter(WL, W)`.
11. Perform `LeaveCriticalSection(WL)`.
12. Let *n* be the number of elements in *S*.
13. Return  $\mathbb{F}(n)$ .

#### 25.4.14 **Atomics.xor** ( *typedArray*, *index*, *value* )

This function performs the following steps when called:

1. Let *xor* be a new [read-modify-write modification function](#) with parameters (*xBytes*, *yBytes*) that captures nothing and performs the following steps atomically when called:
  - a. Return [ByteListBitwiseOp](#)( $\wedge$ , *xBytes*, *yBytes*).
2. Return ? [AtomicReadModifyWrite](#)(*typedArray*, *index*, *value*, *xor*).

#### 25.4.15 **Atomics [ @@toStringTag ]**

The initial value of the [@@toStringTag](#) property is the String value **"Atomics"**.

This property has the attributes { [\[\[Writable\]\]](#): **false**, [\[\[Enumerable\]\]](#): **false**, [\[\[Configurable\]\]](#): **true** }.

### 25.5 The JSON Object

The JSON object:

- is [%JSON%](#).
- is the initial value of the **"JSON"** property of the [global object](#).
- is an [ordinary object](#).
- contains two functions, **parse** and **stringify**, that are used to parse and construct JSON texts.
- has a [\[\[Prototype\]\]](#) internal slot whose value is [%Object.prototype%](#).
- does not have a [\[\[Construct\]\]](#) internal method; it cannot be used as a [constructor](#) with the **new** operator.
- does not have a [\[\[Call\]\]](#) internal method; it cannot be invoked as a function.

The JSON Data Interchange Format is defined in ECMA-404. The JSON interchange format used in this specification is exactly that described by ECMA-404. Conforming implementations of **JSON.parse** and **JSON.stringify** must support the exact interchange format described in the ECMA-404 specification without any deletions or extensions to the format.

#### 25.5.1 **JSON.parse** ( *text* [ , *reviver* ] )

This function parses a JSON text (a JSON-formatted String) and produces an [ECMAScript language value](#). The JSON format represents literals, arrays, and objects with a syntax similar to the syntax for ECMAScript literals, Array Initializers, and Object Initializers. After parsing, JSON objects are realized as ECMAScript objects. JSON arrays are realized as ECMAScript Array instances. JSON strings, numbers, booleans, and null are realized as ECMAScript Strings, Numbers, Booleans, and **null**.

The optional *reviver* parameter is a function that takes two parameters, *key* and *value*. It can filter and transform the results. It is called with each of the *key/value* pairs produced by the parse, and its return value is used instead of the original value. If it returns what it received, the structure is not modified. If it returns **undefined** then the property is deleted from the result.

1. Let *jsonString* be ? [ToString](#)(*text*).
2. Parse [StringToCodePoints](#)(*jsonString*) as a JSON text as specified in ECMA-404. Throw a **SyntaxError** exception if it is not a valid JSON text as defined in that specification.
3. Let *scriptString* be the [string-concatenation](#) of **"(",** *jsonString*, and **");"**.
4. Let *script* be [ParseText](#)([StringToCodePoints](#)(*scriptString*), *Script*).
5. NOTE: The [early error](#) rules defined in [13.2.5.1](#) have special handling for the above invocation of [ParseText](#).
6. **Assert:** *script* is a [Parse Node](#).

7. Let *completion* be *Completion*(*Evaluation* of *script*).
8. NOTE: The *PropertyDefinitionEvaluation* semantics defined in 13.2.5.5 have special handling for the above evaluation.
9. Let *unfiltered* be *completion*.[[Value]].
10. Assert: *unfiltered* is either a String, a Number, a Boolean, an Object that is defined by either an *ArrayLiteral* or an *ObjectLiteral*, or **null**.
11. If *IsCallable*(*reviver*) is **true**, then
  - a. Let *root* be *OrdinaryObjectCreate*(%*Object.prototype*%).
  - b. Let *rootName* be the empty String.
  - c. Perform ! *CreateDataPropertyOrThrow*(*root*, *rootName*, *unfiltered*).
  - d. Return ? *InternalizeJSONProperty*(*root*, *rootName*, *reviver*).
12. Else,
  - a. Return *unfiltered*.

The "length" property of this function is 2<sub>F</sub>.

NOTE Valid JSON text is a subset of the ECMAScript *PrimaryExpression* syntax. Step 2 verifies that *jsonString* conforms to that subset, and step 10 asserts that that parsing and evaluation returns a value of an appropriate type.

However, because 13.2.5.5 behaves differently during **JSON.parse**, the same source text can produce different results when evaluated as a *PrimaryExpression* rather than as JSON. Furthermore, the Early Error for duplicate "**\_\_proto\_\_**" properties in object literals, which likewise does not apply during **JSON.parse**, means that not all texts accepted by **JSON.parse** are valid as a *PrimaryExpression*, despite matching the grammar.

### 25.5.1.1 InternalizeJSONProperty ( *holder*, *name*, *reviver* )

The abstract operation *InternalizeJSONProperty* takes arguments *holder* (an Object), *name* (a String), and *reviver* (a function object) and returns either a normal completion containing an ECMAScript language value or a throw completion.

NOTE 1 This algorithm intentionally does not throw an exception if either [[Delete]] or *CreateDataProperty* return **false**.

It performs the following steps when called:

1. Let *val* be ? *Get*(*holder*, *name*).
2. If *val* is an Object, then
  - a. Let *isArray* be ? *isArray*(*val*).
  - b. If *isArray* is **true**, then
    - i. Let *len* be ? *LengthOfArrayLike*(*val*).
    - ii. Let *l* be 0.
    - iii. Repeat, while *l* < *len*,
      1. Let *prop* be ! *ToString*(*l*).
      2. Let *newElement* be ? *InternalizeJSONProperty*(*val*, *prop*, *reviver*).
      3. If *newElement* is **undefined**, then
        - a. Perform ? *val*.[[Delete]](*prop*).
      4. Else,
        - a. Perform ? *CreateDataProperty*(*val*, *prop*, *newElement*).
    5. Set *l* to *l* + 1.



- c. Else,
  - i. Let *keys* be ? `EnumerableOwnProperties(val, key)`.
  - ii. For each String *P* of *keys*, do
    - 1. Let *newElement* be ? `InternalizeJSONProperty(val, P, reviver)`.
    - 2. If *newElement* is **undefined**, then
      - a. Perform ? `val.[[Delete]](P)`.
    - 3. Else,
      - a. Perform ? `CreateDataProperty(val, P, newElement)`.
- 3. Return ? `Call(reviver, holder, « name, val »)`.

It is not permitted for a conforming implementation of **JSON.parse** to extend the JSON grammars. If an implementation wishes to support a modified or extended JSON interchange format it must do so by defining a different parse function.

NOTE 2 In the case where there are duplicate name Strings within an object, lexically preceding values for the same key shall be overwritten.

### 25.5.2 JSON.stringify ( *value* [ , *replacer* [ , *space* ] ] )

This function returns a String in UTF-16 encoded JSON format representing an [ECMAScript language value](#), or **undefined**. It can take three parameters. The *value* parameter is an [ECMAScript language value](#), which is usually an object or array, although it can also be a String, Boolean, Number or **null**. The optional *replacer* parameter is either a function that alters the way objects and arrays are stringified, or an array of Strings and Numbers that acts as an inclusion list for selecting the object properties that will be stringified. The optional *space* parameter is a String or Number that allows the result to have white space injected into it to improve human readability.

It performs the following steps when called:

1. Let *stack* be a new empty List.
2. Let *indent* be the empty String.
3. Let *PropertyList* be **undefined**.
4. Let *ReplacerFunction* be **undefined**.
5. If *replacer* is an Object, then
  - a. If `IsCallable(replacer)` is **true**, then
    - i. Set *ReplacerFunction* to *replacer*.
  - b. Else,
    - i. Let *isArray* be ? `isArray(replacer)`.
    - ii. If *isArray* is **true**, then
      1. Set *PropertyList* to a new empty List.
      2. Let *len* be ? `LengthOfArrayLike(replacer)`.
      3. Let *k* be 0.
      4. Repeat, while *k* < *len*,
        - a. Let *prop* be ! `ToString(ℱ(k))`.
        - b. Let *v* be ? `Get(replacer, prop)`.
        - c. Let *item* be **undefined**.
        - d. If *v* is a String, set *item* to *v*.
        - e. Else if *v* is a Number, set *item* to ! `ToString(v)`.
        - f. Else if *v* is an Object, then
          - i. If *v* has a `[[StringData]]` or `[[NumberData]]` internal slot, set *item* to ? `ToString(v)`.
        - g. If *item* is not **undefined** and *PropertyList* does not contain *item*, then

- i. Append *item* to *PropertyList*.
    - h. Set *k* to *k* + 1.
  6. If *space* is an Object, then
    - a. If *space* has a [[NumberData]] internal slot, then
      - i. Set *space* to ? *ToNumber(space)*.
    - b. Else if *space* has a [[StringData]] internal slot, then
      - i. Set *space* to ? *Tostring(space)*.
  7. If *space* is a Number, then
    - a. Let *spaceMV* be ! *ToIntegerOrInfinity(space)*.
    - b. Set *spaceMV* to *min(10, spaceMV)*.
    - c. If *spaceMV* < 1, let *gap* be the empty String; otherwise let *gap* be the String value containing *spaceMV* occurrences of the code unit 0x0020 (SPACE).
  8. Else if *space* is a String, then
    - a. If the length of *space* ≤ 10, let *gap* be *space*; otherwise let *gap* be the *substring* of *space* from 0 to 10.
  9. Else,
    - a. Let *gap* be the empty String.
  10. Let *wrapper* be *OrdinaryObjectCreate(%Object.prototype%)*.
  11. Perform ! *CreateDataPropertyOrThrow(wrapper, the empty String, value)*.
  12. Let *state* be the JSON Serialization Record { [[ReplacerFunction]]: *ReplacerFunction*, [[Stack]]: *stack*, [[Indent]]: *indent*, [[Gap]]: *gap*, [[PropertyList]]: *PropertyList* }.
  13. Return ? *SerializeJSONProperty(state, the empty String, wrapper)*.

The "length" property of this function is 3<sub>F</sub>.

NOTE 1 JSON structures are allowed to be nested to any depth, but they must be acyclic. If *value* is or contains a cyclic structure, then this function must throw a **TypeError** exception. This is an example of a value that cannot be stringified:

```
a = [];
a[0] = a;
my_text = JSON.stringify(a); // This must throw a TypeError.
```

NOTE 2 Symbolic primitive values are rendered as follows:

- The **null** value is rendered in JSON text as the String value "null".
- The **undefined** value is not rendered.
- The **true** value is rendered in JSON text as the String value "true".
- The **false** value is rendered in JSON text as the String value "false".

NOTE 3 String values are wrapped in QUOTATION MARK (") code units. The code units " and \ are escaped with \ prefixes. Control characters code units are replaced with escape sequences \uHHHH, or with the shorter forms, \b (BACKSPACE), \f (FORM FEED), \n (LINE FEED), \r (CARRIAGE RETURN), \t (CHARACTER TABULATION).

NOTE 4 **Finite** numbers are stringified as if by calling *Tostring(number)*. **NaN** and **Infinity** regardless of sign are represented as the String value "null".

NOTE 5 Values that do not have a JSON representation (such as **undefined** and functions) do not produce a String. Instead they produce the **undefined** value. In arrays these values are represented as the String value "null". In objects an unrepresentable value causes the property to be excluded from stringification.

NOTE 6 An object is rendered as U+007B (LEFT CURLY BRACKET) followed by zero or more properties, separated with a U+002C (COMMA), closed with a U+007D (RIGHT CURLY BRACKET). A property is a quoted String representing the [property name](#), a U+003A (COLON), and then the stringified property value. An array is rendered as an opening U+005B (LEFT SQUARE BRACKET) followed by zero or more values, separated with a U+002C (COMMA), closed with a U+005D (RIGHT SQUARE BRACKET).

### 25.5.2.1 JSON Serialization Record

A *JSON Serialization Record* is a [Record](#) value used to enable serialization to the JSON format.

JSON Serialization Records have the fields listed in [Table 69](#).

Table 69: JSON Serialization Record Fields

Field Name	Value	Meaning
[[ReplacerFunction]]	a <a href="#">function object</a> or <b>undefined</b>	A function that can supply replacement values for object properties (from JSON.stringify's <a href="#">replacer</a> parameter).
[[PropertyList]]	either a <a href="#">List</a> of Strings or <b>undefined</b>	The names of properties to include when serializing a non-array object (from JSON.stringify's <a href="#">replacer</a> parameter).
[[Gap]]	a String	The unit of indentation (from JSON.stringify's <a href="#">space</a> parameter).
[[Stack]]	a <a href="#">List</a> of Objects	The set of nested objects that are in the process of being serialized. Used to detect cyclic structures.
[[Indent]]	a String	The current indentation.

### 25.5.2.2 SerializeJSONProperty ( [state](#), [key](#), [holder](#) )

The abstract operation `SerializeJSONProperty` takes arguments [state](#) (a [JSON Serialization Record](#)), [key](#) (a String), and [holder](#) (an Object) and returns either a [normal completion](#) containing either a String or **undefined**, or a [throw completion](#). It performs the following steps when called:

1. Let [value](#) be ? [Get](#)([holder](#), [key](#)).
2. If [value](#) is an Object or [value](#) is a BigInt, then
  - a. Let [toJSON](#) be ? [GetV](#)([value](#), "toJSON").
  - b. If [IsCallable](#)([toJSON](#)) is **true**, then
    - i. Set [value](#) to ? [Call](#)([toJSON](#), [value](#), « [key](#) »).
3. If [state](#).[[ReplacerFunction]] is not **undefined**, then
  - a. Set [value](#) to ? [Call](#)([state](#).[[ReplacerFunction]], [holder](#), « [key](#), [value](#) »).
4. If [value](#) is an Object, then
  - a. If [value](#) has a [[NumberData]] internal slot, then
    - i. Set [value](#) to ? [ToNumber](#)([value](#)).
  - b. Else if [value](#) has a [[StringData]] internal slot, then
    - i. Set [value](#) to ? [ToString](#)([value](#)).
  - c. Else if [value](#) has a [[BooleanData]] internal slot, then
    - i. Set [value](#) to [value](#).[[BooleanData]].
  - d. Else if [value](#) has a [[BigIntData]] internal slot, then
    - i. Set [value](#) to [value](#).[[BigIntData]].
5. If [value](#) is **null**, return **"null"**.
6. If [value](#) is **true**, return **"true"**.

7. If *value* is **false**, return **"false"**.
8. If *value* is a String, return `QuoteJSONString(value)`.
9. If *value* is a Number, then
  - a. If *value* is finite, return `! ToString(value)`.
  - b. Return **"null"**.
10. If *value* is a BigInt, throw a **TypeError** exception.
11. If *value* is an Object and `IsCallable(value)` is **false**, then
  - a. Let *isArray* be `? isArray(value)`.
  - b. If *isArray* is **true**, return `? SerializeJSONArray(state, value)`.
  - c. Return `? SerializeJSONObject(state, value)`.
12. Return **undefined**.

### 25.5.2.3 QuoteJSONString ( *value* )

The abstract operation `QuoteJSONString` takes argument *value* (a String) and returns a String. It wraps *value* in 0x0022 (QUOTATION MARK) code units and escapes certain other code units within it. This operation interprets *value* as a sequence of UTF-16 encoded code points, as described in 6.1.4. It performs the following steps when called:

1. Let *product* be the String value consisting solely of the code unit 0x0022 (QUOTATION MARK).
2. For each code point *C* of `StringToCodePoints(value)`, do
  - a. If *C* is listed in the “Code Point” column of Table 70, then
    - i. Set *product* to the string-concatenation of *product* and the escape sequence for *C* as specified in the “Escape Sequence” column of the corresponding row.
  - b. Else if *C* has a numeric value less than 0x0020 (SPACE) or *C* has the same numeric value as a leading surrogate or trailing surrogate, then
    - i. Let *unit* be the code unit whose numeric value is the numeric value of *C*.
    - ii. Set *product* to the string-concatenation of *product* and `UnicodeEscape(unit)`.
  - c. Else,
    - i. Set *product* to the string-concatenation of *product* and `UTF16EncodeCodePoint(C)`.
3. Set *product* to the string-concatenation of *product* and the code unit 0x0022 (QUOTATION MARK).
4. Return *product*.

Table 70: JSON Single Character Escape Sequences

Code Point	Unicode Character Name	Escape Sequence
U+0008	BACKSPACE	<code>\b</code>
U+0009	CHARACTER TABULATION	<code>\t</code>
U+000A	LINE FEED (LF)	<code>\n</code>
U+000C	FORM FEED (FF)	<code>\f</code>
U+000D	CARRIAGE RETURN (CR)	<code>\r</code>
U+0022	QUOTATION MARK	<code>\"</code>
U+005C	REVERSE SOLIDUS	<code>\\</code>

### 25.5.2.4 UnicodeEscape ( *C* )

The abstract operation `UnicodeEscape` takes argument *C* (a code unit) and returns a String. It represents *C* as a Unicode escape sequence. It performs the following steps when called:

1. Let *n* be the numeric value of *C*.
2. **Assert**:  $n \leq 0xFFFF$ .
3. Let *hex* be the String representation of *n*, formatted as a lowercase hexadecimal number.
4. Return the **string-concatenation** of the code unit 0x005C (REVERSE SOLIDUS), "u", and !**StringPad**(*hex*, 4<sub>F</sub>, "0", start).

### 25.5.2.5 SerializeJSONObject ( *state*, *value* )

The abstract operation **SerializeJSONObject** takes arguments *state* (a **JSON Serialization Record**) and *value* (an Object) and returns either a **normal completion containing** a String or a **throw completion**. It serializes an object. It performs the following steps when called:

1. If *state*.[[Stack]] contains *value*, throw a **TypeError** exception because the structure is cyclical.
2. Append *value* to *state*.[[Stack]].
3. Let *stepback* be *state*.[[Indent]].
4. Set *state*.[[Indent]] to the **string-concatenation** of *state*.[[Indent]] and *state*.[[Gap]].
5. If *state*.[[PropertyList]] is not **undefined**, then
  - a. Let *K* be *state*.[[PropertyList]].
6. Else,
  - a. Let *K* be ? **EnumerableOwnProperties**(*value*, key).
7. Let *partial* be a new empty List.
8. For each element *P* of *K*, do
  - a. Let *strP* be ? **SerializeJSONProperty**(*state*, *P*, *value*).
  - b. If *strP* is not **undefined**, then
    - i. Let *member* be **QuoteJSONString**(*P*).
    - ii. Set *member* to the **string-concatenation** of *member* and ":".
    - iii. If *state*.[[Gap]] is not the empty String, then
      1. Set *member* to the **string-concatenation** of *member* and the code unit 0x0020 (SPACE).
    - iv. Set *member* to the **string-concatenation** of *member* and *strP*.
    - v. Append *member* to *partial*.
9. If *partial* is empty, then
  - a. Let *final* be "{}".
10. Else,
  - a. If *state*.[[Gap]] is the empty String, then
    - i. Let *properties* be the String value formed by concatenating all the element Strings of *partial* with each adjacent pair of Strings separated with the code unit 0x002C (COMMA). A comma is not inserted either before the first String or after the last String.
    - ii. Let *final* be the **string-concatenation** of "{", *properties*, and "}".
  - b. Else,
    - i. Let *separator* be the **string-concatenation** of the code unit 0x002C (COMMA), the code unit 0x000A (LINE FEED), and *state*.[[Indent]].
    - ii. Let *properties* be the String value formed by concatenating all the element Strings of *partial* with each adjacent pair of Strings separated with *separator*. The *separator* String is not inserted either before the first String or after the last String.
    - iii. Let *final* be the **string-concatenation** of "{", the code unit 0x000A (LINE FEED), *state*.[[Indent]], *properties*, the code unit 0x000A (LINE FEED), *stepback*, and "}".
11. Remove the last element of *state*.[[Stack]].
12. Set *state*.[[Indent]] to *stepback*.
13. Return *final*.

### 25.5.2.6 SerializeJSONArray ( *state*, *value* )

The abstract operation `SerializeJSONArray` takes arguments *state* (a JSON Serialization Record) and *value* (an ECMAScript language value) and returns either a normal completion containing a String or a throw completion. It serializes an array. It performs the following steps when called:

1. If *state*.[[Stack]] contains *value*, throw a **TypeError** exception because the structure is cyclical.
2. Append *value* to *state*.[[Stack]].
3. Let *stepback* be *state*.[[Indent]].
4. Set *state*.[[Indent]] to the string-concatenation of *state*.[[Indent]] and *state*.[[Gap]].
5. Let *partial* be a new empty List.
6. Let *len* be ? `LengthOfArrayLike(value)`.
7. Let *index* be 0.
8. Repeat, while *index* < *len*,
  - a. Let *strP* be ? `SerializeJSONProperty(state, ! ToString(F(index)), value)`.
  - b. If *strP* is **undefined**, then
    - i. Append **"null"** to *partial*.
  - c. Else,
    - i. Append *strP* to *partial*.
  - d. Set *index* to *index* + 1.
9. If *partial* is empty, then
  - a. Let *final* be **"[]"**.
10. Else,
  - a. If *state*.[[Gap]] is the empty String, then
    - i. Let *properties* be the String value formed by concatenating all the element Strings of *partial* with each adjacent pair of Strings separated with the code unit 0x002C (COMMA). A comma is not inserted either before the first String or after the last String.
    - ii. Let *final* be the string-concatenation of **"["**, *properties*, and **"]"**.
  - b. Else,
    - i. Let *separator* be the string-concatenation of the code unit 0x002C (COMMA), the code unit 0x000A (LINE FEED), and *state*.[[Indent]].
    - ii. Let *properties* be the String value formed by concatenating all the element Strings of *partial* with each adjacent pair of Strings separated with *separator*. The *separator* String is not inserted either before the first String or after the last String.
    - iii. Let *final* be the string-concatenation of **"["**, the code unit 0x000A (LINE FEED), *state*.[[Indent]], *properties*, the code unit 0x000A (LINE FEED), *stepback*, and **"]"**.
11. Remove the last element of *state*.[[Stack]].
12. Set *state*.[[Indent]] to *stepback*.
13. Return *final*.

**NOTE** The representation of arrays includes only the elements in the interval from **+0<sub>F</sub>** (inclusive) to **array.length** (exclusive). Properties whose keys are not **array indices** are excluded from the stringification. An array is stringified as an opening LEFT SQUARE BRACKET, elements separated by COMMA, and a closing RIGHT SQUARE BRACKET.

### 25.5.3 JSON [ @@toStringTag ]

The initial value of the `@@toStringTag` property is the String value **"JSON"**.

This property has the attributes { `[[Writable]]`: **false**, `[[Enumerable]]`: **false**, `[[Configurable]]`: **true** }.

## 26 Managing Memory

### 26.1 WeakRef Objects

A [WeakRef](#) is an object that is used to refer to a target object or symbol without preserving it from garbage collection. [WeakRefs](#) can be dereferenced to allow access to the target value, if the target hasn't been reclaimed by garbage collection.

#### 26.1.1 The WeakRef Constructor

The *WeakRef* constructor:

- is `%WeakRef%`.
- is the initial value of the **"WeakRef"** property of the [global object](#).
- creates and initializes a new WeakRef when called as a [constructor](#).
- is not intended to be called as a function and will throw an exception when called in that manner.
- may be used as the value in an **extends** clause of a class definition. Subclass [constructors](#) that intend to inherit the specified **WeakRef** behaviour must include a **super** call to the [WeakRef constructor](#) to create and initialize the subclass instance with the internal state necessary to support the **WeakRef.prototype** built-in methods.

##### 26.1.1.1 WeakRef ( *target* )

This function performs the following steps when called:

1. If `NewTarget` is **undefined**, throw a **TypeError** exception.
2. If `CanBeHeldWeakly(target)` is **false**, throw a **TypeError** exception.
3. Let `weakRef` be ? [OrdinaryCreateFromConstructor](#)(`NewTarget`, **"%WeakRef.prototype%"**, «  
[[`WeakRefTarget`]] »).
4. Perform [AddToKeptObjects\(\*target\*\)](#).
5. Set `weakRef.[[WeakRefTarget]]` to `target`.
6. Return `weakRef`.

#### 26.1.2 Properties of the WeakRef Constructor

The *WeakRef* constructor:

- has a `[[Prototype]]` internal slot whose value is `%Function.prototype%`.
- has the following properties:

##### 26.1.2.1 WeakRef.prototype

The initial value of **WeakRef.prototype** is the [WeakRef prototype](#) object.

This property has the attributes { `[[Writable]]`: **false**, `[[Enumerable]]`: **false**, `[[Configurable]]`: **false** }.

#### 26.1.3 Properties of the WeakRef Prototype Object

The *WeakRef prototype* object:

- is `%WeakRef.prototype%`.
- has a `[[Prototype]]` internal slot whose value is `%Object.prototype%`.
- is an [ordinary object](#).
- does not have a `[[WeakRefTarget]]` internal slot.

#### NORMATIVE OPTIONAL

##### 26.1.3.1 WeakRef.prototype.constructor

The initial value of `WeakRef.prototype.constructor` is `%WeakRef%`.

This property has the attributes { `[[Writable]]`: **false**, `[[Enumerable]]`: **false**, `[[Configurable]]`: **true** }.

##### 26.1.3.2 WeakRef.prototype.deref ( )

This method performs the following steps when called:

1. Let *weakRef* be the **this** value.
2. Perform ? [RequireInternalSlot](#)(*weakRef*, `[[WeakRefTarget]]`).
3. Return [WeakRefDeref](#)(*weakRef*).

**NOTE** If the [WeakRef](#) returns a *target* value that is not **undefined**, then this *target* value should not be garbage collected until the current execution of ECMAScript code has completed. The [AddToKeptObjects](#) operation makes sure read consistency is maintained.

```
let target = { foo() {} };
let weakRef = new WeakRef(target);

// ... later ...

if (weakRef.deref()) {
  weakRef.deref().foo();
}
```

In the above example, if the first deref does not evaluate to **undefined** then the second deref cannot either.

##### 26.1.3.3 WeakRef.prototype [ @@toStringTag ]

The initial value of the `@@toStringTag` property is the String value **"WeakRef"**.

This property has the attributes { `[[Writable]]`: **false**, `[[Enumerable]]`: **false**, `[[Configurable]]`: **true** }.

#### 26.1.4 WeakRef Abstract Operations

##### 26.1.4.1 WeakRefDeref ( *weakRef* )

The abstract operation [WeakRefDeref](#) takes argument *weakRef* (a [WeakRef](#)) and returns an [ECMAScript language value](#). It performs the following steps when called:

1. Let *target* be *weakRef*.`[[WeakRefTarget]]`.
2. If *target* is not empty, then



- a. Perform `AddToKeptObjects(target)`.
  - b. Return `target`.
3. Return **undefined**.

**NOTE** This abstract operation is defined separately from `WeakRef.prototype.deref` strictly to make it possible to succinctly define liveness.

### 26.1.5 Properties of WeakRef Instances

`WeakRef` instances are [ordinary objects](#) that inherit properties from the `WeakRef` prototype. `WeakRef` instances also have a `[[WeakRefTarget]]` internal slot.

## 26.2 FinalizationRegistry Objects

A `FinalizationRegistry` is an object that manages registration and unregistration of cleanup operations that are performed when target objects and symbols are garbage collected.

### 26.2.1 The FinalizationRegistry Constructor

The `FinalizationRegistry` constructor:

- is `%FinalizationRegistry%`.
- is the initial value of the **"FinalizationRegistry"** property of the [global object](#).
- creates and initializes a new `FinalizationRegistry` when called as a [constructor](#).
- is not intended to be called as a function and will throw an exception when called in that manner.
- may be used as the value in an **extends** clause of a class definition. Subclass [constructors](#) that intend to inherit the specified **FinalizationRegistry** behaviour must include a **super** call to the **FinalizationRegistry** constructor to create and initialize the subclass instance with the internal state necessary to support the `FinalizationRegistry.prototype` built-in methods.

#### 26.2.1.1 FinalizationRegistry ( *cleanupCallback* )

This function performs the following steps when called:

1. If `NewTarget` is **undefined**, throw a **TypeError** exception.
2. If `IsCallable(cleanupCallback)` is **false**, throw a **TypeError** exception.
3. Let `finalizationRegistry` be `? OrdinaryCreateFromConstructor(NewTarget, "%FinalizationRegistry.prototype%", « [[Realm]], [[CleanupCallback]], [[Cells]] »)`.
4. Let `fn` be the [active function object](#).
5. Set `finalizationRegistry.[[Realm]]` to `fn.[[Realm]]`.
6. Set `finalizationRegistry.[[CleanupCallback]]` to `HostMakeJobCallback(cleanupCallback)`.
7. Set `finalizationRegistry.[[Cells]]` to a new empty [List](#).
8. Return `finalizationRegistry`.

### 26.2.2 Properties of the FinalizationRegistry Constructor

The `FinalizationRegistry` constructor:

- has a `[[Prototype]]` internal slot whose value is `%Function.prototype%`.
- has the following properties:

### 26.2.2.1 FinalizationRegistry.prototype

The initial value of `FinalizationRegistry.prototype` is the [FinalizationRegistry prototype](#) object.

This property has the attributes { `[[Writable]]`: **false**, `[[Enumerable]]`: **false**, `[[Configurable]]`: **false** }.

### 26.2.3 Properties of the FinalizationRegistry Prototype Object

The *FinalizationRegistry prototype* object:

- is `%FinalizationRegistry.prototype%`.
- has a `[[Prototype]]` internal slot whose value is `%Object.prototype%`.
- is an [ordinary object](#).
- does not have `[[Cells]]` and `[[CleanupCallback]]` internal slots.

#### 26.2.3.1 FinalizationRegistry.prototype.constructor

The initial value of `FinalizationRegistry.prototype.constructor` is `%FinalizationRegistry%`.

#### 26.2.3.2 FinalizationRegistry.prototype.register ( *target*, *heldValue* [ , *unregisterToken* ] )

This method performs the following steps when called:

1. Let *finalizationRegistry* be the **this** value.
2. Perform ? [RequireInternalSlot](#)(*finalizationRegistry*, `[[Cells]]`).
3. If [CanBeHeldWeakly](#)(*target*) is **false**, throw a **TypeError** exception.
4. If [SameValue](#)(*target*, *heldValue*) is **true**, throw a **TypeError** exception.
5. If [CanBeHeldWeakly](#)(*unregisterToken*) is **false**, then
  - a. If *unregisterToken* is not **undefined**, throw a **TypeError** exception.
  - b. Set *unregisterToken* to empty.
6. Let *cell* be the [Record](#) { `[[WeakRefTarget]]`: *target*, `[[HeldValue]]`: *heldValue*, `[[UnregisterToken]]`: *unregisterToken* }.
7. Append *cell* to *finalizationRegistry*.`[[Cells]]`.
8. Return **undefined**.

**NOTE** Based on the algorithms and definitions in this specification, *cell*.`[[HeldValue]]` is [live](#) when *finalizationRegistry*.`[[Cells]]` contains *cell*; however, this does not necessarily mean that *cell*.`[[UnregisterToken]]` or *cell*.`[[Target]]` are [live](#). For example, registering an object with itself as its unregister token would not keep the object alive forever.

#### 26.2.3.3 FinalizationRegistry.prototype.unregister ( *unregisterToken* )

This method performs the following steps when called:

1. Let *finalizationRegistry* be the **this** value.
2. Perform ? [RequireInternalSlot](#)(*finalizationRegistry*, `[[Cells]]`).
3. If [CanBeHeldWeakly](#)(*unregisterToken*) is **false**, throw a **TypeError** exception.
4. Let *removed* be **false**.
5. For each [Record](#) { `[[WeakRefTarget]]`, `[[HeldValue]]`, `[[UnregisterToken]]` } *cell* of *finalizationRegistry*.`[[Cells]]`, do

- a. If `cell.[[UnregisterToken]]` is not empty and `SameValue(cell.[[UnregisterToken]], unregisterToken)` is **true**, then
  - i. Remove `cell` from `finalizationRegistry.[[Cells]]`.
  - ii. Set `removed` to **true**.
- 6. Return `removed`.

### 26.2.3.4 FinalizationRegistry.prototype [ @@toStringTag ]

The initial value of the `@@toStringTag` property is the String value **"FinalizationRegistry"**.

This property has the attributes { `[[Writable]]`: **false**, `[[Enumerable]]`: **false**, `[[Configurable]]`: **true** }.

### 26.2.4 Properties of FinalizationRegistry Instances

`FinalizationRegistry` instances are **ordinary objects** that inherit properties from the `FinalizationRegistry` prototype. `FinalizationRegistry` instances also have `[[Cells]]` and `[[CleanupCallback]]` internal slots.

## 27 Control Abstraction Objects

### 27.1 Iteration

#### 27.1.1 Common Iteration Interfaces

An interface is a set of **property keys** whose associated values match a specific specification. Any object that provides all the properties as described by an interface's specification *conforms* to that interface. An interface is not represented by a distinct object. There may be many separately implemented objects that conform to any interface. An individual object may conform to multiple interfaces.

##### 27.1.1.1 The *Iterable* Interface

The *Iterable* interface includes the property described in [Table 71](#):

**Table 71: *Iterable* Interface Required Properties**

Property	Value	Requirements
<code>@@iterator</code>	a function that returns an <i>Iterator</i> object	The returned object must conform to the <i>Iterator</i> interface.

##### 27.1.1.2 The *Iterator* Interface

An object that implements the *Iterator* interface must include the property in [Table 72](#). Such objects may also implement the properties in [Table 73](#).

Table 72: *Iterator* Interface Required Properties

Property	Value	Requirements
"next"	a function that returns an <i>IteratorResult</i> object	The returned object must conform to the <i>IteratorResult</i> interface. If a previous call to the <b>next</b> method of an <i>Iterator</i> has returned an <i>IteratorResult</i> object whose <b>"done"</b> property is <b>true</b> , then all subsequent calls to the <b>next</b> method of that object should also return an <i>IteratorResult</i> object whose <b>"done"</b> property is <b>true</b> . However, this requirement is not enforced.

NOTE 1 Arguments may be passed to the **next** function but their interpretation and validity is dependent upon the target *Iterator*. The for-of statement and other common users of *Iterators* do not pass any arguments, so *Iterator* objects that expect to be used in such a manner must be prepared to deal with being called with no arguments.

Table 73: *Iterator* Interface Optional Properties

Property	Value	Requirements
"return"	a function that returns an <i>IteratorResult</i> object	The returned object must conform to the <i>IteratorResult</i> interface. Invoking this method notifies the <i>Iterator</i> object that the caller does not intend to make any more <b>next</b> method calls to the <i>Iterator</i> . The returned <i>IteratorResult</i> object will typically have a <b>"done"</b> property whose value is <b>true</b> , and a <b>"value"</b> property with the value passed as the argument of the <b>return</b> method. However, this requirement is not enforced.
"throw"	a function that returns an <i>IteratorResult</i> object	The returned object must conform to the <i>IteratorResult</i> interface. Invoking this method notifies the <i>Iterator</i> object that the caller has detected an error condition. The argument may be used to identify the error condition and typically will be an exception object. A typical response is to <b>throw</b> the value passed as the argument. If the method does not <b>throw</b> , the returned <i>IteratorResult</i> object will typically have a <b>"done"</b> property whose value is <b>true</b> .

NOTE 2 Typically callers of these methods should check for their existence before invoking them. Certain ECMAScript language features including **for-of**, **yield\***, and array destructuring call these methods after performing an existence check. Most ECMAScript library functions that accept *Iterable* objects as arguments also conditionally call them.

### 27.1.1.3 The *AsyncIterable* Interface

The *AsyncIterable* interface includes the properties described in Table 74:

Table 74: *AsyncIterable* Interface Required Properties

Property	Value	Requirements
<b>@@asyncIterator</b>	a function that returns an <i>AsyncIterator</i> object	The returned object must conform to the <i>AsyncIterator</i> interface.

### 27.1.1.4 The *AsyncIterator* Interface

An object that implements the *AsyncIterator* interface must include the properties in Table 75. Such objects may also implement the properties in Table 76.

Table 75: *AsyncIterator* Interface Required Properties

Property	Value	Requirements
"next"	a function that returns a promise for an <i>IteratorResult</i> object	<p>The returned promise, when fulfilled, must fulfill with an object that conforms to the <i>IteratorResult</i> interface. If a previous call to the <b>next</b> method of an <i>AsyncIterator</i> has returned a promise for an <i>IteratorResult</i> object whose <b>"done"</b> property is <b>true</b>, then all subsequent calls to the <b>next</b> method of that object should also return a promise for an <i>IteratorResult</i> object whose <b>"done"</b> property is <b>true</b>. However, this requirement is not enforced.</p> <p>Additionally, the <i>IteratorResult</i> object that serves as a fulfillment value should have a <b>"value"</b> property whose value is not a promise (or "thenable"). However, this requirement is also not enforced.</p>

NOTE 1 Arguments may be passed to the **next** function but their interpretation and validity is dependent upon the target *AsyncIterator*. The **for-await-of** statement and other common users of *AsyncIterators* do not pass any arguments, so *AsyncIterator* objects that expect to be used in such a manner must be prepared to deal with being called with no arguments.

Table 76: *AsyncIterator* Interface Optional Properties

Property	Value	Requirements
"return"	a function that returns a promise for an <i>IteratorResult</i> object	<p>The returned promise, when fulfilled, must fulfill with an object that conforms to the <i>IteratorResult</i> interface. Invoking this method notifies the <i>AsyncIterator</i> object that the caller does not intend to make any more <b>next</b> method calls to the <i>AsyncIterator</i>. The returned promise will fulfill with an <i>IteratorResult</i> object which will typically have a <b>"done"</b> property whose value is <b>true</b>, and a <b>"value"</b> property with the value passed as the argument of the <b>return</b> method. However, this requirement is not enforced.</p> <p>Additionally, the <i>IteratorResult</i> object that serves as a fulfillment value should have a <b>"value"</b> property whose value is not a promise (or "thenable"). If the argument value is used in the typical manner, then if it is a rejected promise, a promise rejected with the same reason should be returned; if it is a fulfilled promise, then its fulfillment value should be used as the <b>"value"</b> property of the returned promise's <i>IteratorResult</i> object fulfillment value. However, these requirements are also not enforced.</p>
"throw"	a function that returns a promise for an <i>IteratorResult</i> object	<p>The returned promise, when fulfilled, must fulfill with an object that conforms to the <i>IteratorResult</i> interface. Invoking this method notifies the <i>AsyncIterator</i> object that the caller has detected an error condition. The argument may be used to identify the error condition and typically will be an exception object. A typical response is to return a rejected promise which rejects with the value passed as the argument.</p> <p>If the returned promise is fulfilled, the <i>IteratorResult</i> fulfillment value will typically have a <b>"done"</b> property whose value is <b>true</b>. Additionally, it should have a <b>"value"</b> property whose value is not a promise (or "thenable"), but this requirement is not enforced.</p>

NOTE 2 Typically callers of these methods should check for their existence before invoking them. Certain ECMAScript language features including **for-await-of** and **yield\*** call these methods after performing an existence check.

### 27.1.1.5 The *IteratorResult* Interface

The *IteratorResult* interface includes the properties listed in [Table 77](#):

Table 77: *IteratorResult* Interface Properties

Property	Value	Requirements
"done"	a Boolean	This is the result status of an <i>iterator</i> <b>next</b> method call. If the end of the iterator was reached <b>"done"</b> is <b>true</b> . If the end was not reached <b>"done"</b> is <b>false</b> and a value is available. If a <b>"done"</b> property (either own or inherited) does not exist, it is considered to have the value <b>false</b> .
"value"	an <a href="#">ECMAScript language value</a>	If done is <b>false</b> , this is the current iteration element value. If done is <b>true</b> , this is the return value of the iterator, if it supplied one. If the iterator does not have a return value, <b>"value"</b> is <b>undefined</b> . In that case, the <b>"value"</b> property may be absent from the conforming object if it does not inherit an explicit <b>"value"</b> property.

### 27.1.2 The *%IteratorPrototype%* Object

The *%IteratorPrototype%* object:

- has a [\[\[Prototype\]\]](#) internal slot whose value is [%Object.prototype%](#).
- is an [ordinary object](#).

NOTE All objects defined in this specification that implement the *Iterator* interface also inherit from *%IteratorPrototype%*. ECMAScript code may also define objects that inherit from *%IteratorPrototype%*. The *%IteratorPrototype%* object provides a place where additional methods that are applicable to all iterator objects may be added.

The following expression is one way that ECMAScript code can access the *%IteratorPrototype%* object:

```
Object.getPrototypeOf(Object.getPrototypeOf([][Symbol.iterator]()))
```

#### 27.1.2.1 *%IteratorPrototype%* [ @@iterator ] ( )

This function performs the following steps when called:

1. Return the **this** value.

The value of the **"name"** property of this function is **"[Symbol.iterator]"**.

### 27.1.3 The *%AsyncIteratorPrototype%* Object

The *%AsyncIteratorPrototype%* object:

- has a [\[\[Prototype\]\]](#) internal slot whose value is [%Object.prototype%](#).
- is an [ordinary object](#).

NOTE All objects defined in this specification that implement the AsyncIterator interface also inherit from %AsyncIteratorPrototype%. ECMAScript code may also define objects that inherit from %AsyncIteratorPrototype%. The %AsyncIteratorPrototype% object provides a place where additional methods that are applicable to all async iterator objects may be added.

### 27.1.3.1 %AsyncIteratorPrototype% [ @@asyncIterator ] ( )

This function performs the following steps when called:

1. Return the **this** value.

The value of the "name" property of this function is "[Symbol.asyncIterator]"

### 27.1.4 Async-from-Sync Iterator Objects

An Async-from-Sync Iterator object is an async iterator that adapts a specific synchronous iterator. There is not a named [constructor](#) for Async-from-Sync Iterator objects. Instead, Async-from-Sync iterator objects are created by the [CreateAsyncFromSyncIterator](#) abstract operation as needed.

#### 27.1.4.1 CreateAsyncFromSyncIterator ( *syncIteratorRecord* )

The abstract operation [CreateAsyncFromSyncIterator](#) takes argument *syncIteratorRecord* (an [Iterator Record](#)) and returns an [Iterator Record](#). It is used to create an async [Iterator Record](#) from a synchronous [Iterator Record](#). It performs the following steps when called:

1. Let *asyncIterator* be [OrdinaryObjectCreate](#)(%AsyncFromSyncIteratorPrototype%, « [[SyncIteratorRecord]] »).
2. Set *asyncIterator*.[[SyncIteratorRecord]] to *syncIteratorRecord*.
3. Let *nextMethod* be ! [Get](#)(*asyncIterator*, "next").
4. Let *iteratorRecord* be the [Iterator Record](#) { [[Iterator]]: *asyncIterator*, [[NextMethod]]: *nextMethod*, [[Done]]: **false** }.
5. Return *iteratorRecord*.

#### 27.1.4.2 The %AsyncFromSyncIteratorPrototype% Object

The %[AsyncFromSyncIteratorPrototype](#)% object:

- has properties that are inherited by all Async-from-Sync Iterator Objects.
- is an [ordinary object](#).
- has a [[Prototype]] internal slot whose value is %[AsyncIteratorPrototype](#)%.
- has the following properties:

##### 27.1.4.2.1 %AsyncFromSyncIteratorPrototype%.next ( [ *value* ] )

1. Let *O* be the **this** value.
2. **Assert**: *O* is an [Object](#) that has a [[SyncIteratorRecord]] internal slot.
3. Let *promiseCapability* be ! [NewPromiseCapability](#)(%[Promise](#)%).
4. Let *syncIteratorRecord* be *O*.[[SyncIteratorRecord]].
5. If *value* is present, then
  - a. Let *result* be [Completion](#)([IteratorNext](#)(*syncIteratorRecord*, *value*)).
6. Else,

- a. Let *result* be `Completion(IteratorNext(syncIteratorRecord))`.
7. `IfAbruptRejectPromise(result, promiseCapability)`.
8. Return `AsyncFromSyncIteratorContinuation(result, promiseCapability)`.

#### 27.1.4.2.2 %AsyncFromSyncIteratorPrototype%.return ( [ *value* ] )

1. Let *O* be the **this** value.
2. **Assert**: *O* is an Object that has a `[[SyncIteratorRecord]]` internal slot.
3. Let *promiseCapability* be ! `NewPromiseCapability(%Promise%)`.
4. Let *syncIterator* be *O*.`[[SyncIteratorRecord]].[[Iterator]]`.
5. Let *return* be `Completion(GetMethod(syncIterator, "return"))`.
6. `IfAbruptRejectPromise(return, promiseCapability)`.
7. If *return* is **undefined**, then
  - a. Let *iterResult* be `CreateIterResultObject(value, true)`.
  - b. Perform ! `Call(promiseCapability.[[Resolve]], undefined, « iterResult »)`.
  - c. Return `promiseCapability.[[Promise]]`.
8. If *value* is present, then
  - a. Let *result* be `Completion(Call(return, syncIterator, « value »))`.
9. Else,
  - a. Let *result* be `Completion(Call(return, syncIterator))`.
10. `IfAbruptRejectPromise(result, promiseCapability)`.
11. If *result* is not an Object, then
  - a. Perform ! `Call(promiseCapability.[[Reject]], undefined, « a newly created TypeError object »)`.
  - b. Return `promiseCapability.[[Promise]]`.
12. Return `AsyncFromSyncIteratorContinuation(result, promiseCapability)`.

#### 27.1.4.2.3 %AsyncFromSyncIteratorPrototype%.throw ( [ *value* ] )

**NOTE** In this specification, *value* is always provided, but is left optional for consistency with `%AsyncFromSyncIteratorPrototype%.return ( [ value ] )`.

1. Let *O* be the **this** value.
2. **Assert**: *O* is an Object that has a `[[SyncIteratorRecord]]` internal slot.
3. Let *promiseCapability* be ! `NewPromiseCapability(%Promise%)`.
4. Let *syncIterator* be *O*.`[[SyncIteratorRecord]].[[Iterator]]`.
5. Let *throw* be `Completion(GetMethod(syncIterator, "throw"))`.
6. `IfAbruptRejectPromise(throw, promiseCapability)`.
7. If *throw* is **undefined**, then
  - a. Perform ! `Call(promiseCapability.[[Reject]], undefined, « value »)`.
  - b. Return `promiseCapability.[[Promise]]`.
8. If *value* is present, then
  - a. Let *result* be `Completion(Call(throw, syncIterator, « value »))`.
9. Else,
  - a. Let *result* be `Completion(Call(throw, syncIterator))`.
10. `IfAbruptRejectPromise(result, promiseCapability)`.
11. If *result* is not an Object, then
  - a. Perform ! `Call(promiseCapability.[[Reject]], undefined, « a newly created TypeError object »)`.
  - b. Return `promiseCapability.[[Promise]]`.
12. Return `AsyncFromSyncIteratorContinuation(result, promiseCapability)`.



### 27.1.4.3 Properties of Async-from-Sync Iterator Instances

Async-from-Sync Iterator instances are [ordinary objects](#) that inherit properties from the [%AsyncFromSyncIteratorPrototype%](#) intrinsic object. Async-from-Sync Iterator instances are initially created with the internal slots listed in [Table 78](#). Async-from-Sync Iterator instances are not directly observable from ECMAScript code.

Table 78: Internal Slots of Async-from-Sync Iterator Instances

Internal Slot	Type	Description
[[SyncIteratorRecord]]	an <a href="#">Iterator Record</a>	Represents the original synchronous iterator which is being adapted.

### 27.1.4.4 AsyncFromSyncIteratorContinuation ( *result*, *promiseCapability* )

The abstract operation AsyncFromSyncIteratorContinuation takes arguments *result* (an Object) and *promiseCapability* (a [PromiseCapability Record](#) for an intrinsic [%Promise%](#)) and returns a Promise. It performs the following steps when called:

1. NOTE: Because *promiseCapability* is derived from the intrinsic [%Promise%](#), the calls to [promiseCapability.\[\[Reject\]\]](#) entailed by the use [IfAbruptRejectPromise](#) below are guaranteed not to throw.
2. Let *done* be [Completion\(IteratorComplete\(result\)\)](#).
3. [IfAbruptRejectPromise\(done, promiseCapability\)](#).
4. Let *value* be [Completion\(IteratorValue\(result\)\)](#).
5. [IfAbruptRejectPromise\(value, promiseCapability\)](#).
6. Let *valueWrapper* be [Completion\(PromiseResolve\(%Promise%, value\)\)](#).
7. [IfAbruptRejectPromise\(valueWrapper, promiseCapability\)](#).
8. Let *unwrap* be a new [Abstract Closure](#) with parameters (*v*) that captures *done* and performs the following steps when called:
  - a. Return [CreateIterResultObject\(v, done\)](#).
9. Let *onFulfilled* be [CreateBuiltinFunction\(unwrap, 1, "", « »\)](#).
10. NOTE: *onFulfilled* is used when processing the "value" property of an [IteratorResult](#) object in order to wait for its value if it is a promise and re-package the result in a new "unwrapped" [IteratorResult](#) object.
11. Perform [PerformPromiseThen\(valueWrapper, onFulfilled, undefined, promiseCapability\)](#).
12. Return [promiseCapability.\[\[Promise\]\]](#).

## 27.2 Promise Objects

A Promise is an object that is used as a placeholder for the eventual results of a deferred (and possibly asynchronous) computation.

Any Promise is in one of three mutually exclusive states: *fulfilled*, *rejected*, and *pending*:

- A promise *p* is fulfilled if *p.then(f, r)* will immediately enqueue a [Job](#) to call the function *f*.
- A promise *p* is rejected if *p.then(f, r)* will immediately enqueue a [Job](#) to call the function *r*.
- A promise is pending if it is neither fulfilled nor rejected.

A promise is said to be *settled* if it is not pending, i.e. if it is either fulfilled or rejected.

A promise is *resolved* if it is settled or if it has been “locked in” to match the state of another promise. Attempting to resolve or reject a resolved promise has no effect. A promise is *unresolved* if it is not resolved. An unresolved promise is always in the pending state. A resolved promise may be pending, fulfilled or rejected.

## 27.2.1 Promise Abstract Operations

### 27.2.1.1 PromiseCapability Records

A *PromiseCapability Record* is a [Record](#) value used to encapsulate a Promise or promise-like object along with the functions that are capable of resolving or rejecting that promise. PromiseCapability Records are produced by the [NewPromiseCapability](#) abstract operation.

PromiseCapability Records have the fields listed in [Table 79](#).

**Table 79: PromiseCapability Record Fields**

Field Name	Value	Meaning
[[Promise]]	an Object	An object that is usable as a promise.
[[Resolve]]	a <a href="#">function object</a>	The function that is used to resolve the given promise.
[[Reject]]	a <a href="#">function object</a>	The function that is used to reject the given promise.

#### 27.2.1.1.1 IfAbruptRejectPromise ( *value*, *capability* )

IfAbruptRejectPromise is a shorthand for a sequence of algorithm steps that use a [PromiseCapability Record](#). An algorithm step of the form:

1. IfAbruptRejectPromise(*value*, *capability*).

means the same thing as:

1. Assert: *value* is a [Completion Record](#).
2. If *value* is an [abrupt completion](#), then
  - a. Perform ? Call(*capability*.[[Reject]], **undefined**, « *value*.[[Value]] »).
  - b. Return *capability*.[[Promise]].
3. Else, set *value* to *value*.[[Value]].

#### 27.2.1.2 PromiseReaction Records

The PromiseReaction is a [Record](#) value used to store information about how a promise should react when it becomes resolved or rejected with a given value. PromiseReaction records are created by the [PerformPromiseThen](#) abstract operation, and are used by the [Abstract Closure](#) returned by [NewPromiseReactionJob](#).

PromiseReaction records have the fields listed in [Table 80](#).

Table 80: PromiseReaction **Record** Fields

Field Name	Value	Meaning
[[Capability]]	a <a href="#">PromiseCapability Record</a> or <b>undefined</b>	The capabilities of the promise for which this record provides a reaction handler.
[[Type]]	Fulfill or Reject	The [[Type]] is used when [[Handler]] is empty to allow for behaviour specific to the settlement type.
[[Handler]]	a <a href="#">JobCallback Record</a> or empty	The function that should be applied to the incoming value, and whose return value will govern what happens to the derived promise. If [[Handler]] is empty, a function that depends on the value of [[Type]] will be used instead.

### 27.2.1.3 CreateResolvingFunctions ( *promise* )

The abstract operation CreateResolvingFunctions takes argument *promise* (a Promise) and returns a [Record](#) with fields [[Resolve]] (a [function object](#)) and [[Reject]] (a [function object](#)). It performs the following steps when called:

1. Let *alreadyResolved* be the [Record](#) { [[Value]]: **false** }.
2. Let *stepsResolve* be the algorithm steps defined in [Promise Resolve Functions](#).
3. Let *lengthResolve* be the number of non-optional parameters of the function definition in [Promise Resolve Functions](#).
4. Let *resolve* be [CreateBuiltinFunction](#)(*stepsResolve*, *lengthResolve*, "", « [[Promise]], [[AlreadyResolved]] »).
5. Set *resolve*.[[Promise]] to *promise*.
6. Set *resolve*.[[AlreadyResolved]] to *alreadyResolved*.
7. Let *stepsReject* be the algorithm steps defined in [Promise Reject Functions](#).
8. Let *lengthReject* be the number of non-optional parameters of the function definition in [Promise Reject Functions](#).
9. Let *reject* be [CreateBuiltinFunction](#)(*stepsReject*, *lengthReject*, "", « [[Promise]], [[AlreadyResolved]] »).
10. Set *reject*.[[Promise]] to *promise*.
11. Set *reject*.[[AlreadyResolved]] to *alreadyResolved*.
12. Return the [Record](#) { [[Resolve]]: *resolve*, [[Reject]]: *reject* }.

#### 27.2.1.3.1 Promise Reject Functions

A promise reject function is an anonymous built-in function that has [[Promise]] and [[AlreadyResolved]] internal slots.

When a promise reject function is called with argument *reason*, the following steps are taken:

1. Let *F* be the [active function object](#).
2. **Assert:** *F* has a [[Promise]] internal slot whose value is an [Object](#).
3. Let *promise* be *F*.[[Promise]].
4. Let *alreadyResolved* be *F*.[[AlreadyResolved]].
5. If *alreadyResolved*.[[Value]] is **true**, return **undefined**.
6. Set *alreadyResolved*.[[Value]] to **true**.
7. Perform [RejectPromise](#)(*promise*, *reason*).
8. Return **undefined**.

The "length" property of a promise reject function is 1<sub>F</sub>.

### 27.2.1.3.2 Promise Resolve Functions

A promise resolve function is an anonymous built-in function that has `[[Promise]]` and `[[AlreadyResolved]]` internal slots.

When a promise resolve function is called with argument *resolution*, the following steps are taken:

1. Let *F* be the [active function object](#).
2. **Assert:** *F* has a `[[Promise]]` internal slot whose value is an [Object](#).
3. Let *promise* be *F*.`[[Promise]]`.
4. Let *alreadyResolved* be *F*.`[[AlreadyResolved]]`.
5. If *alreadyResolved*.`[[Value]]` is **true**, return **undefined**.
6. Set *alreadyResolved*.`[[Value]]` to **true**.
7. If `SameValue(resolution, promise)` is **true**, then
  - a. Let *selfResolutionError* be a newly created **TypeError** object.
  - b. Perform `RejectPromise(promise, selfResolutionError)`.
  - c. Return **undefined**.
8. If *resolution* is not an [Object](#), then
  - a. Perform `FulfillPromise(promise, resolution)`.
  - b. Return **undefined**.
9. Let *then* be `Completion(Get(resolution, "then"))`.
10. If *then* is an [abrupt completion](#), then
  - a. Perform `RejectPromise(promise, then. [[Value]])`.
  - b. Return **undefined**.
11. Let *thenAction* be *then*.`[[Value]]`.
12. If `IsCallable(thenAction)` is **false**, then
  - a. Perform `FulfillPromise(promise, resolution)`.
  - b. Return **undefined**.
13. Let *thenJobCallback* be `HostMakeJobCallback(thenAction)`.
14. Let *job* be `NewPromiseResolveThenableJob(promise, resolution, thenJobCallback)`.
15. Perform `HostEnqueuePromiseJob(job. [[Job]], job. [[Realm]])`.
16. Return **undefined**.

The "length" property of a promise resolve function is 1<sub>F</sub>.

### 27.2.1.4 FulfillPromise ( *promise*, *value* )

The abstract operation `FulfillPromise` takes arguments *promise* (a [Promise](#)) and *value* (an [ECMAScript language value](#)) and returns `unused`. It performs the following steps when called:

1. **Assert:** The value of *promise*.`[[PromiseState]]` is `pending`.
2. Let *reactions* be *promise*.`[[PromiseFulfillReactions]]`.
3. Set *promise*.`[[PromiseResult]]` to *value*.
4. Set *promise*.`[[PromiseFulfillReactions]]` to **undefined**.
5. Set *promise*.`[[PromiseRejectReactions]]` to **undefined**.
6. Set *promise*.`[[PromiseState]]` to `fulfilled`.
7. Perform `TriggerPromiseReactions(reactions, value)`.
8. Return `unused`.

### 27.2.1.5 NewPromiseCapability ( C )

The abstract operation NewPromiseCapability takes argument *C* (an [ECMAScript language value](#)) and returns either a [normal completion containing a PromiseCapability Record](#) or a [throw completion](#). It attempts to use *C* as a [constructor](#) in the fashion of the built-in Promise [constructor](#) to create a promise and extract its **resolve** and **reject** functions. The promise plus the **resolve** and **reject** functions are used to initialize a new [PromiseCapability Record](#). It performs the following steps when called:

1. If [IsConstructor](#)(*C*) is **false**, throw a **TypeError** exception.
2. NOTE: *C* is assumed to be a [constructor](#) function that supports the parameter conventions of the Promise [constructor](#) (see 27.2.3.1).
3. Let *resolvingFunctions* be the [Record](#) { [\[\[Resolve\]\]](#): **undefined**, [\[\[Reject\]\]](#): **undefined** }.
4. Let *executorClosure* be a new [Abstract Closure](#) with parameters (*resolve*, *reject*) that captures *resolvingFunctions* and performs the following steps when called:
  - a. If *resolvingFunctions*.[\[\[Resolve\]\]](#) is not **undefined**, throw a **TypeError** exception.
  - b. If *resolvingFunctions*.[\[\[Reject\]\]](#) is not **undefined**, throw a **TypeError** exception.
  - c. Set *resolvingFunctions*.[\[\[Resolve\]\]](#) to *resolve*.
  - d. Set *resolvingFunctions*.[\[\[Reject\]\]](#) to *reject*.
  - e. Return **undefined**.
5. Let *executor* be [CreateBuiltinFunction](#)(*executorClosure*, 2, "", « »).
6. Let *promise* be ? [Construct](#)(*C*, « *executor* »).
7. If [IsCallable](#)(*resolvingFunctions*.[\[\[Resolve\]\]](#)) is **false**, throw a **TypeError** exception.
8. If [IsCallable](#)(*resolvingFunctions*.[\[\[Reject\]\]](#)) is **false**, throw a **TypeError** exception.
9. Return the [PromiseCapability Record](#) { [\[\[Promise\]\]](#): *promise*, [\[\[Resolve\]\]](#): *resolvingFunctions*.[\[\[Resolve\]\]](#), [\[\[Reject\]\]](#): *resolvingFunctions*.[\[\[Reject\]\]](#) }.

**NOTE** This abstract operation supports Promise subclassing, as it is generic on any [constructor](#) that calls a passed executor function argument in the same way as the Promise [constructor](#). It is used to generalize static methods of the Promise [constructor](#) to any subclass.

### 27.2.1.6 IsPromise ( x )

The abstract operation IsPromise takes argument *x* (an [ECMAScript language value](#)) and returns a Boolean. It checks for the promise brand on an object. It performs the following steps when called:

1. If *x* is not an [Object](#), return **false**.
2. If *x* does not have a [\[\[PromiseState\]\]](#) internal slot, return **false**.
3. Return **true**.

### 27.2.1.7 RejectPromise ( *promise*, *reason* )

The abstract operation RejectPromise takes arguments *promise* (a Promise) and *reason* (an [ECMAScript language value](#)) and returns unused. It performs the following steps when called:

1. [Assert](#): The value of *promise*.[\[\[PromiseState\]\]](#) is pending.
2. Let *reactions* be *promise*.[\[\[PromiseRejectReactions\]\]](#).
3. Set *promise*.[\[\[PromiseResult\]\]](#) to *reason*.
4. Set *promise*.[\[\[PromiseFulfillReactions\]\]](#) to **undefined**.
5. Set *promise*.[\[\[PromiseRejectReactions\]\]](#) to **undefined**.
6. Set *promise*.[\[\[PromiseState\]\]](#) to rejected.
7. If *promise*.[\[\[PromiseIsHandled\]\]](#) is **false**, perform [HostPromiseRejectionTracker](#)(*promise*, "reject").
8. Perform [TriggerPromiseReactions](#)(*reactions*, *reason*).
9. Return unused.

### 27.2.1.8 TriggerPromiseReactions ( *reactions*, *argument* )

The abstract operation `TriggerPromiseReactions` takes arguments *reactions* (a List of `PromiseReaction Records`) and *argument* (an ECMAScript language value) and returns `unused`. It enqueues a new `Job` for each record in *reactions*. Each such `Job` processes the `[[Type]]` and `[[Handler]]` of the `PromiseReaction Record`, and if the `[[Handler]]` is not empty, calls it passing the given argument. If the `[[Handler]]` is empty, the behaviour is determined by the `[[Type]]`. It performs the following steps when called:

1. For each element *reaction* of *reactions*, do
  - a. Let *job* be `NewPromiseReactionJob(reaction, argument)`.
  - b. Perform `HostEnqueuePromiseJob(job.[[Job]], job.[[Realm]])`.
2. Return `unused`.

### 27.2.1.9 HostPromiseRejectionTracker ( *promise*, *operation* )

The *host-defined* abstract operation `HostPromiseRejectionTracker` takes arguments *promise* (a `Promise`) and *operation* ("`reject`" or "`handle`") and returns `unused`. It allows *host environments* to track promise rejections.

An implementation of `HostPromiseRejectionTracker` must conform to the following requirements:

- It must complete normally (i.e. not return an *abrupt completion*).

The default implementation of `HostPromiseRejectionTracker` is to return `unused`.

NOTE 1 `HostPromiseRejectionTracker` is called in two scenarios:

- When a promise is rejected without any handlers, it is called with its *operation* argument set to "`reject`".
- When a handler is added to a rejected promise for the first time, it is called with its *operation* argument set to "`handle`".

A typical implementation of `HostPromiseRejectionTracker` might try to notify developers of unhandled rejections, while also being careful to notify them if such previous notifications are later invalidated by new handlers being attached.

NOTE 2 If *operation* is "`handle`", an implementation should not hold a reference to *promise* in a way that would interfere with garbage collection. An implementation may hold a reference to *promise* if *operation* is "`reject`", since it is expected that rejections will be rare and not on hot code paths.

## 27.2.2 Promise Jobs

### 27.2.2.1 NewPromiseReactionJob ( *reaction*, *argument* )

The abstract operation `NewPromiseReactionJob` takes arguments *reaction* (a `PromiseReaction Record`) and *argument* (an ECMAScript language value) and returns a `Record` with fields `[[Job]]` (a `Job Abstract Closure`) and `[[Realm]]` (a `Realm Record` or `null`). It returns a new `Job Abstract Closure` that applies the appropriate handler to the incoming value, and uses the handler's return value to resolve or reject the derived promise associated with that handler. It performs the following steps when called:

1. Let *job* be a new `Job Abstract Closure` with no parameters that captures *reaction* and *argument* and performs the following steps when called:

- a. Let *promiseCapability* be *reaction*.[[Capability]].
  - b. Let *type* be *reaction*.[[Type]].
  - c. Let *handler* be *reaction*.[[Handler]].
  - d. If *handler* is empty, then
    - i. If *type* is Fulfill, let *handlerResult* be *NormalCompletion*(*argument*).
    - ii. Else,
      1. Assert: *type* is Reject.
      2. Let *handlerResult* be *ThrowCompletion*(*argument*).
  - e. Else, let *handlerResult* be *Completion*(*HostCallJobCallback*(*handler*, **undefined**, « *argument* »)).
  - f. If *promiseCapability* is **undefined**, then
    - i. Assert: *handlerResult* is not an abrupt completion.
    - ii. Return empty.
  - g. Assert: *promiseCapability* is a *PromiseCapability Record*.
  - h. If *handlerResult* is an abrupt completion, then
    - i. Return ? *Call*(*promiseCapability*.[[Reject]], **undefined**, « *handlerResult*.[[Value]] »).
  - i. Else,
    - i. Return ? *Call*(*promiseCapability*.[[Resolve]], **undefined**, « *handlerResult*.[[Value]] »).
2. Let *handlerRealm* be **null**.
  3. If *reaction*.[[Handler]] is not empty, then
    - a. Let *getHandlerRealmResult* be *Completion*(*GetFunctionRealm*(*reaction*.[[Handler]].[[Callback]])).
    - b. If *getHandlerRealmResult* is a normal completion, set *handlerRealm* to *getHandlerRealmResult*.[[Value]].
    - c. Else, set *handlerRealm* to the current *Realm Record*.
    - d. NOTE: *handlerRealm* is never **null** unless the handler is **undefined**. When the handler is a revoked Proxy and no ECMAScript code runs, *handlerRealm* is used to create error objects.
  4. Return the *Record* { [[Job]]: *job*, [[Realm]]: *handlerRealm* }.

### 27.2.2.2 NewPromiseResolveThenableJob ( *promiseToResolve*, *thenable*, *then* )

The abstract operation *NewPromiseResolveThenableJob* takes arguments *promiseToResolve* (a Promise), *thenable* (an Object), and *then* (a *JobCallback Record*) and returns a *Record* with fields [[Job]] (a *Job Abstract Closure*) and [[Realm]] (a *Realm Record*). It performs the following steps when called:

1. Let *job* be a new *Job Abstract Closure* with no parameters that captures *promiseToResolve*, *thenable*, and *then* and performs the following steps when called:
  - a. Let *resolvingFunctions* be *CreateResolvingFunctions*(*promiseToResolve*).
  - b. Let *thenCallResult* be *Completion*(*HostCallJobCallback*(*then*, *thenable*, « *resolvingFunctions*.[[Resolve]], *resolvingFunctions*.[[Reject]] »)).
  - c. If *thenCallResult* is an abrupt completion, then
    - i. Return ? *Call*(*resolvingFunctions*.[[Reject]], **undefined**, « *thenCallResult*.[[Value]] »).
  - d. Return ? *thenCallResult*.
2. Let *getThenRealmResult* be *Completion*(*GetFunctionRealm*(*then*.[[Callback]])).
3. If *getThenRealmResult* is a normal completion, let *thenRealm* be *getThenRealmResult*.[[Value]].
4. Else, let *thenRealm* be the current *Realm Record*.
5. NOTE: *thenRealm* is never **null**. When *then*.[[Callback]] is a revoked Proxy and no code runs, *thenRealm* is used to create error objects.
6. Return the *Record* { [[Job]]: *job*, [[Realm]]: *thenRealm* }.

**NOTE** This *Job* uses the supplied *thenable* and its **then** method to resolve the given promise. This process must take place as a *Job* to ensure that the evaluation of the **then** method occurs

## 27.2.3 The Promise Constructor

The Promise [constructor](#):

- is `%Promise%`.
- is the initial value of the **"Promise"** property of the [global object](#).
- creates and initializes a new Promise when called as a [constructor](#).
- is not intended to be called as a function and will throw an exception when called in that manner.
- may be used as the value in an **extends** clause of a class definition. Subclass [constructors](#) that intend to inherit the specified Promise behaviour must include a **super** call to the Promise [constructor](#) to create and initialize the subclass instance with the internal state necessary to support the **Promise** and **Promise.prototype** built-in methods.

### 27.2.3.1 Promise ( [executor](#) )

This function performs the following steps when called:

1. If `NewTarget` is **undefined**, throw a **TypeError** exception.
2. If `IsCallable(executor)` is **false**, throw a **TypeError** exception.
3. Let `promise` be ? [OrdinaryCreateFromConstructor](#)(`NewTarget`, **"%Promise.prototype%"**, « `[[PromiseState]]`, `[[PromiseResult]]`, `[[PromiseFulfillReactions]]`, `[[PromiseRejectReactions]]`, `[[PromiselsHandled]]` »).
4. Set `promise`.`[[PromiseState]]` to **pending**.
5. Set `promise`.`[[PromiseFulfillReactions]]` to a new empty [List](#).
6. Set `promise`.`[[PromiseRejectReactions]]` to a new empty [List](#).
7. Set `promise`.`[[PromiselsHandled]]` to **false**.
8. Let `resolvingFunctions` be [CreateResolvingFunctions](#)(`promise`).
9. Let `completion` be [Completion](#)(`Call`(`executor`, **undefined**, « `resolvingFunctions`.`[[Resolve]]`, `resolvingFunctions`.`[[Reject]]` »)).
10. If `completion` is an [abrupt completion](#), then
  - a. Perform ? `Call`(`resolvingFunctions`.`[[Reject]]`, **undefined**, « `completion`.`[[Value]]` »).
11. Return `promise`.

**NOTE** The [executor](#) argument must be a [function object](#). It is called for initiating and reporting completion of the possibly deferred action represented by this Promise. The executor is called with two arguments: [resolve](#) and [reject](#). These are functions that may be used by the [executor](#) function to report eventual completion or failure of the deferred computation. Returning from the executor function does not mean that the deferred action has been completed but only that the request to eventually perform the deferred action has been accepted.

The [resolve](#) function that is passed to an [executor](#) function accepts a single argument. The [executor](#) code may eventually call the [resolve](#) function to indicate that it wishes to resolve the associated Promise. The argument passed to the [resolve](#) function represents the eventual value of the deferred action and can be either the actual fulfillment value or another promise which will provide the value if it is fulfilled.

The [reject](#) function that is passed to an [executor](#) function accepts a single argument. The [executor](#) code may eventually call the [reject](#) function to indicate that the associated Promise is rejected and will never be fulfilled. The argument passed to the [reject](#) function is used as the rejection value of the promise. Typically it will be an Error object.

The [resolve](#) and [reject](#) functions passed to an [executor](#) function by the Promise [constructor](#) have the capability to actually resolve and reject the associated promise. Subclasses may have different [constructor](#) behaviour that passes in customized values for [resolve](#) and [reject](#).



## 27.2.4 Properties of the Promise Constructor

The Promise [constructor](#):

- has a `[[Prototype]]` internal slot whose value is `%Function.prototype%`.
- has the following properties:

### 27.2.4.1 Promise.all ( *iterable* )

This function returns a new promise which is fulfilled with an array of fulfillment values for the passed promises, or rejects with the reason of the first passed promise that rejects. It resolves all elements of the passed iterable to promises as it runs this algorithm.

1. Let *C* be the **this** value.
2. Let *promiseCapability* be ? [NewPromiseCapability](#)(*C*).
3. Let *promiseResolve* be [Completion](#)([GetPromiseResolve](#)(*C*)).
4. [IfAbruptRejectPromise](#)(*promiseResolve*, *promiseCapability*).
5. Let *iteratorRecord* be [Completion](#)([GetIterator](#)(*iterable*, sync)).
6. [IfAbruptRejectPromise](#)(*iteratorRecord*, *promiseCapability*).
7. Let *result* be [Completion](#)([PerformPromiseAll](#)(*iteratorRecord*, *C*, *promiseCapability*, *promiseResolve*)).
8. If *result* is an abrupt completion, then
  - a. If *iteratorRecord*.`[[Done]]` is **false**, set *result* to [Completion](#)([IteratorClose](#)(*iteratorRecord*, *result*)).
  - b. [IfAbruptRejectPromise](#)(*result*, *promiseCapability*).
9. Return ? *result*.

**NOTE** This function requires its **this** value to be a [constructor](#) function that supports the parameter conventions of the [Promise constructor](#).

#### 27.2.4.1.1 GetPromiseResolve ( *promiseConstructor* )

The abstract operation [GetPromiseResolve](#) takes argument *promiseConstructor* (a [constructor](#)) and returns either a [normal completion](#) containing a function object or a [throw completion](#). It performs the following steps when called:

1. Let *promiseResolve* be ? [Get](#)(*promiseConstructor*, "resolve").
2. If [IsCallable](#)(*promiseResolve*) is **false**, throw a **TypeError** exception.
3. Return *promiseResolve*.

#### 27.2.4.1.2 PerformPromiseAll ( *iteratorRecord*, *constructor*, *resultCapability*, *promiseResolve* )

The abstract operation [PerformPromiseAll](#) takes arguments *iteratorRecord* (an [Iterator Record](#)), *constructor* (a [constructor](#)), *resultCapability* (a [PromiseCapability Record](#)), and *promiseResolve* (a function object) and returns either a [normal completion](#) containing an ECMAScript language value or a [throw completion](#). It performs the following steps when called:

1. Let *values* be a new empty [List](#).
2. Let *remainingElementsCount* be the [Record](#) { `[[Value]]`: 1 }.
3. Let *index* be 0.
4. Repeat,
  - a. Let *next* be [Completion](#)([IteratorStep](#)(*iteratorRecord*)).
  - b. If *next* is an abrupt completion, set *iteratorRecord*.`[[Done]]` to **true**.

- c. ReturnIfAbrupt(*next*).
- d. If *next* is **false**, then
  - i. Set *iteratorRecord*.[[Done]] to **true**.
  - ii. Set *remainingElementsCount*.[[Value]] to *remainingElementsCount*.[[Value]] - 1.
  - iii. If *remainingElementsCount*.[[Value]] = 0, then
    - 1. Let *valuesArray* be *CreateArrayFromList*(*values*).
    - 2. Perform ? *Call*(*resultCapability*.[[Resolve]], **undefined**, « *valuesArray* »).
  - iv. Return *resultCapability*.[[Promise]].
- e. Let *nextValue* be *Completion*(*IteratorValue*(*next*)).
- f. If *nextValue* is an abrupt completion, set *iteratorRecord*.[[Done]] to **true**.
- g. ReturnIfAbrupt(*nextValue*).
- h. Append **undefined** to *values*.
- i. Let *nextPromise* be ? *Call*(*promiseResolve*, *constructor*, « *nextValue* »).
- j. Let *steps* be the algorithm steps defined in **Promise.all** Resolve Element Functions.
- k. Let *length* be the number of non-optional parameters of the function definition in **Promise.all** Resolve Element Functions.
- l. Let *onFulfilled* be *CreateBuiltinFunction*(*steps*, *length*, "", « [[AlreadyCalled]], [[Index]], [[Values]], [[Capability]], [[RemainingElements]] »).
- m. Set *onFulfilled*.[[AlreadyCalled]] to **false**.
- n. Set *onFulfilled*.[[Index]] to *index*.
- o. Set *onFulfilled*.[[Values]] to *values*.
- p. Set *onFulfilled*.[[Capability]] to *resultCapability*.
- q. Set *onFulfilled*.[[RemainingElements]] to *remainingElementsCount*.
- r. Set *remainingElementsCount*.[[Value]] to *remainingElementsCount*.[[Value]] + 1.
- s. Perform ? *Invoke*(*nextPromise*, "then", « *onFulfilled*, *resultCapability*.[[Reject]] »).
- t. Set *index* to *index* + 1.

### 27.2.4.1.3 Promise.all Resolve Element Functions

A **Promise.all** resolve element function is an anonymous built-in function that is used to resolve a specific **Promise.all** element. Each **Promise.all** resolve element function has [[Index]], [[Values]], [[Capability]], [[RemainingElements]], and [[AlreadyCalled]] internal slots.

When a **Promise.all** resolve element function is called with argument *x*, the following steps are taken:

1. Let *F* be the active function object.
2. If *F*.[[AlreadyCalled]] is **true**, return **undefined**.
3. Set *F*.[[AlreadyCalled]] to **true**.
4. Let *index* be *F*.[[Index]].
5. Let *values* be *F*.[[Values]].
6. Let *promiseCapability* be *F*.[[Capability]].
7. Let *remainingElementsCount* be *F*.[[RemainingElements]].
8. Set *values*[*index*] to *x*.
9. Set *remainingElementsCount*.[[Value]] to *remainingElementsCount*.[[Value]] - 1.
10. If *remainingElementsCount*.[[Value]] = 0, then
  - a. Let *valuesArray* be *CreateArrayFromList*(*values*).
  - b. Return ? *Call*(*promiseCapability*.[[Resolve]], **undefined**, « *valuesArray* »).
11. Return **undefined**.

The "length" property of a **Promise.all** resolve element function is 1<sub>F</sub>.

### 27.2.4.2 Promise.allSettled ( *iterable* )

This function returns a promise that is fulfilled with an array of promise state snapshots, but only after all the original promises have settled, i.e. become either fulfilled or rejected. It resolves all elements of the passed iterable to promises as it runs this algorithm.

1. Let *C* be the **this** value.
2. Let *promiseCapability* be ? `NewPromiseCapability(C)`.
3. Let *promiseResolve* be `Completion(GetPromiseResolve(C))`.
4. `IfAbruptRejectPromise(promiseResolve, promiseCapability)`.
5. Let *iteratorRecord* be `Completion(GetIterator(iterable, sync))`.
6. `IfAbruptRejectPromise(iteratorRecord, promiseCapability)`.
7. Let *result* be `Completion(PerformPromiseAllSettled(iteratorRecord, C, promiseCapability, promiseResolve))`.
8. If *result* is an abrupt completion, then
  - a. If *iteratorRecord*.[[Done]] is **false**, set *result* to `Completion(IteratorClose(iteratorRecord, result))`.
  - b. `IfAbruptRejectPromise(result, promiseCapability)`.
9. Return ? *result*.

**NOTE** This function requires its **this** value to be a `constructor` function that supports the parameter conventions of the `Promise constructor`.

#### 27.2.4.2.1 PerformPromiseAllSettled ( *iteratorRecord*, *constructor*, *resultCapability*, *promiseResolve* )

The abstract operation `PerformPromiseAllSettled` takes arguments *iteratorRecord* (an `Iterator Record`), *constructor* (a `constructor`), *resultCapability* (a `PromiseCapability Record`), and *promiseResolve* (a function object) and returns either a normal completion containing an ECMAScript language value or a throw completion. It performs the following steps when called:

1. Let *values* be a new empty `List`.
2. Let *remainingElementsCount* be the `Record` { [[Value]]: 1 }.
3. Let *index* be 0.
4. Repeat,
  - a. Let *next* be `Completion(IteratorStep(iteratorRecord))`.
  - b. If *next* is an abrupt completion, set *iteratorRecord*.[[Done]] to **true**.
  - c. `ReturnIfAbrupt(next)`.
  - d. If *next* is **false**, then
    - i. Set *iteratorRecord*.[[Done]] to **true**.
    - ii. Set *remainingElementsCount*.[[Value]] to *remainingElementsCount*.[[Value]] - 1.
    - iii. If *remainingElementsCount*.[[Value]] = 0, then
      1. Let *valuesArray* be `CreateArrayFromList(values)`.
      2. Perform ? `Call(resultCapability.[[Resolve]], undefined, « valuesArray »)`.
    - iv. Return *resultCapability*.[[Promise]].
  - e. Let *nextValue* be `Completion(IteratorValue(next))`.
  - f. If *nextValue* is an abrupt completion, set *iteratorRecord*.[[Done]] to **true**.
  - g. `ReturnIfAbrupt(nextValue)`.
  - h. Append **undefined** to *values*.
  - i. Let *nextPromise* be ? `Call(promiseResolve, constructor, « nextValue »)`.
  - j. Let *stepsFulfilled* be the algorithm steps defined in `Promise.allSettled Resolve Element Functions`.

- k. Let *lengthFulfilled* be the number of non-optional parameters of the function definition in **Promise.allSettled** Resolve Element Functions.
- l. Let *onFulfilled* be `CreateBuiltinFunction(stepsFulfilled, lengthFulfilled, "", « [[AlreadyCalled]], [[Index]], [[Values]], [[Capability]], [[RemainingElements]] »)`.
- m. Let *alreadyCalled* be the `Record` { `[[Value]]: false` }.
- n. Set *onFulfilled*.`[[AlreadyCalled]]` to *alreadyCalled*.
- o. Set *onFulfilled*.`[[Index]]` to *index*.
- p. Set *onFulfilled*.`[[Values]]` to *values*.
- q. Set *onFulfilled*.`[[Capability]]` to *resultCapability*.
- r. Set *onFulfilled*.`[[RemainingElements]]` to *remainingElementsCount*.
- s. Let *stepsRejected* be the algorithm steps defined in **Promise.allSettled** Reject Element Functions.
- t. Let *lengthRejected* be the number of non-optional parameters of the function definition in **Promise.allSettled** Reject Element Functions.
- u. Let *onRejected* be `CreateBuiltinFunction(stepsRejected, lengthRejected, "", « [[AlreadyCalled]], [[Index]], [[Values]], [[Capability]], [[RemainingElements]] »)`.
- v. Set *onRejected*.`[[AlreadyCalled]]` to *alreadyCalled*.
- w. Set *onRejected*.`[[Index]]` to *index*.
- x. Set *onRejected*.`[[Values]]` to *values*.
- y. Set *onRejected*.`[[Capability]]` to *resultCapability*.
- z. Set *onRejected*.`[[RemainingElements]]` to *remainingElementsCount*.
- aa. Set *remainingElementsCount*.`[[Value]]` to *remainingElementsCount*.`[[Value]]` + 1.
- ab. Perform ? `Invoke(nextPromise, "then", « onFulfilled, onRejected »)`.
- ac. Set *index* to *index* + 1.

#### 27.2.4.2.2 Promise.allSettled Resolve Element Functions

A **Promise.allSettled** resolve element function is an anonymous built-in function that is used to resolve a specific **Promise.allSettled** element. Each **Promise.allSettled** resolve element function has `[[Index]]`, `[[Values]]`, `[[Capability]]`, `[[RemainingElements]]`, and `[[AlreadyCalled]]` internal slots.

When a **Promise.allSettled** resolve element function is called with argument *x*, the following steps are taken:

1. Let *F* be the active function object.
2. Let *alreadyCalled* be *F*.`[[AlreadyCalled]]`.
3. If *alreadyCalled*.`[[Value]]` is **true**, return **undefined**.
4. Set *alreadyCalled*.`[[Value]]` to **true**.
5. Let *index* be *F*.`[[Index]]`.
6. Let *values* be *F*.`[[Values]]`.
7. Let *promiseCapability* be *F*.`[[Capability]]`.
8. Let *remainingElementsCount* be *F*.`[[RemainingElements]]`.
9. Let *obj* be `OrdinaryObjectCreate(%Object.prototype%)`.
10. Perform ! `CreateDataPropertyOrThrow(obj, "status", "fulfilled")`.
11. Perform ! `CreateDataPropertyOrThrow(obj, "value", x)`.
12. Set *values*[*index*] to *obj*.
13. Set *remainingElementsCount*.`[[Value]]` to *remainingElementsCount*.`[[Value]]` - 1.
14. If *remainingElementsCount*.`[[Value]]` = 0, then
  - a. Let *valuesArray* be `CreateArrayFromList(values)`.
  - b. Return ? `Call(promiseCapability.[[Resolve]], undefined, « valuesArray »)`.
15. Return **undefined**.

The "length" property of a **Promise.allSettled** resolve element function is 1<sub>F</sub>.

### 27.2.4.2.3 Promise.allSettled Reject Element Functions

A **Promise.allSettled** reject element function is an anonymous built-in function that is used to reject a specific **Promise.allSettled** element. Each **Promise.allSettled** reject element function has `[[Index]]`, `[[Values]]`, `[[Capability]]`, `[[RemainingElements]]`, and `[[AlreadyCalled]]` internal slots.

When a **Promise.allSettled** reject element function is called with argument *x*, the following steps are taken:

1. Let *F* be the *active function object*.
2. Let *alreadyCalled* be *F*.`[[AlreadyCalled]]`.
3. If *alreadyCalled*.`[[Value]]` is **true**, return **undefined**.
4. Set *alreadyCalled*.`[[Value]]` to **true**.
5. Let *index* be *F*.`[[Index]]`.
6. Let *values* be *F*.`[[Values]]`.
7. Let *promiseCapability* be *F*.`[[Capability]]`.
8. Let *remainingElementsCount* be *F*.`[[RemainingElements]]`.
9. Let *obj* be `OrdinaryObjectCreate(%Object.prototype%)`.
10. Perform ! `CreateDataPropertyOrThrow(obj, "status", "rejected")`.
11. Perform ! `CreateDataPropertyOrThrow(obj, "reason", x)`.
12. Set *values*[*index*] to *obj*.
13. Set *remainingElementsCount*.`[[Value]]` to *remainingElementsCount*.`[[Value]]` - 1.
14. If *remainingElementsCount*.`[[Value]]` = 0, then
  - a. Let *valuesArray* be `CreateArrayFromList(values)`.
  - b. Return ? `Call(promiseCapability. [[Resolve]], undefined, « valuesArray »)`.
15. Return **undefined**.

The "length" property of a **Promise.allSettled** reject element function is 1<sub>F</sub>.

### 27.2.4.3 Promise.any ( *iterable* )

This function returns a promise that is fulfilled by the first given promise to be fulfilled, or rejected with an **AggregateError** holding the rejection reasons if all of the given promises are rejected. It resolves all elements of the passed iterable to promises as it runs this algorithm.

1. Let *C* be the **this** value.
2. Let *promiseCapability* be ? `NewPromiseCapability(C)`.
3. Let *promiseResolve* be `Completion(GetPromiseResolve(C))`.
4. `IfAbruptRejectPromise(promiseResolve, promiseCapability)`.
5. Let *iteratorRecord* be `Completion(GetIterator(iterable, sync))`.
6. `IfAbruptRejectPromise(iteratorRecord, promiseCapability)`.
7. Let *result* be `Completion(PerformPromiseAny(iteratorRecord, C, promiseCapability, promiseResolve))`.
8. If *result* is an **abrupt completion**, then
  - a. If *iteratorRecord*.`[[Done]]` is **false**, set *result* to `Completion(IteratorClose(iteratorRecord, result))`.
  - b. `IfAbruptRejectPromise(result, promiseCapability)`.
9. Return ? *result*.

NOTE This function requires its **this** value to be a **constructor** function that supports the parameter conventions of the **Promise constructor**.

#### 27.2.4.3.1 PerformPromiseAny ( *iteratorRecord*, *constructor*, *resultCapability*, *promiseResolve* )

The abstract operation PerformPromiseAny takes arguments *iteratorRecord* (an Iterator Record), *constructor* (a **constructor**), *resultCapability* (a **PromiseCapability Record**), and *promiseResolve* (a function object) and returns either a **normal completion** containing an ECMAScript language value or a **throw completion**. It performs the following steps when called:

1. Let *errors* be a new empty **List**.
2. Let *remainingElementsCount* be the **Record** { **[[Value]]**: 1 }.
3. Let *index* be 0.
4. Repeat,
  - a. Let *next* be **Completion**(**IteratorStep**(*iteratorRecord*)).
  - b. If *next* is an **abrupt completion**, set *iteratorRecord*.**[[Done]]** to **true**.
  - c. **ReturnIfAbrupt**(*next*).
  - d. If *next* is **false**, then
    - i. Set *iteratorRecord*.**[[Done]]** to **true**.
    - ii. Set *remainingElementsCount*.**[[Value]]** to *remainingElementsCount*.**[[Value]]** - 1.
    - iii. If *remainingElementsCount*.**[[Value]]** = 0, then
      1. Let *error* be a newly created **AggregateError** object.
      2. Perform ! **DefinePropertyOrThrow**(*error*, **"errors"**, **PropertyDescriptor** { **[[Configurable]]**: **true**, **[[Enumerable]]**: **false**, **[[Writable]]**: **true**, **[[Value]]**: **CreateArrayFromList**(*errors*) }).
      3. Return **ThrowCompletion**(*error*).
    - iv. Return *resultCapability*.**[[Promise]]**.
  - e. Let *nextValue* be **Completion**(**IteratorValue**(*next*)).
  - f. If *nextValue* is an **abrupt completion**, set *iteratorRecord*.**[[Done]]** to **true**.
  - g. **ReturnIfAbrupt**(*nextValue*).
  - h. Append **undefined** to *errors*.
  - i. Let *nextPromise* be ? **Call**(*promiseResolve*, *constructor*, « *nextValue* »).
  - j. Let *stepsRejected* be the algorithm steps defined in **Promise.any Reject Element Functions**.
  - k. Let *lengthRejected* be the number of non-optional parameters of the function definition in **Promise.any Reject Element Functions**.
  - l. Let *onRejected* be **CreateBuiltinFunction**(*stepsRejected*, *lengthRejected*, **""**, « **[[AlreadyCalled]]**, **[[Index]]**, **[[Errors]]**, **[[Capability]]**, **[[RemainingElements]]** »).
  - m. Set *onRejected*.**[[AlreadyCalled]]** to **false**.
  - n. Set *onRejected*.**[[Index]]** to *index*.
  - o. Set *onRejected*.**[[Errors]]** to *errors*.
  - p. Set *onRejected*.**[[Capability]]** to *resultCapability*.
  - q. Set *onRejected*.**[[RemainingElements]]** to *remainingElementsCount*.
  - r. Set *remainingElementsCount*.**[[Value]]** to *remainingElementsCount*.**[[Value]]** + 1.
  - s. Perform ? **Invoke**(*nextPromise*, **"then"**, « *resultCapability*.**[[Resolve]]**, *onRejected* »).
  - t. Set *index* to *index* + 1.

#### 27.2.4.3.2 Promise.any Reject Element Functions

A **Promise.any** reject element function is an anonymous built-in function that is used to reject a specific **Promise.any** element. Each **Promise.any** reject element function has **[[Index]]**, **[[Errors]]**, **[[Capability]]**, **[[RemainingElements]]**, and **[[AlreadyCalled]]** internal slots.

When a **Promise.any** reject element function is called with argument *x*, the following steps are taken:

1. Let *F* be the [active function object](#).
2. If *F*.[[AlreadyCalled]] is **true**, return **undefined**.
3. Set *F*.[[AlreadyCalled]] to **true**.
4. Let *index* be *F*.[[Index]].
5. Let *errors* be *F*.[[Errors]].
6. Let *promiseCapability* be *F*.[[Capability]].
7. Let *remainingElementsCount* be *F*.[[RemainingElements]].
8. Set *errors*[*index*] to *x*.
9. Set *remainingElementsCount*.[[Value]] to *remainingElementsCount*.[[Value]] - 1.
10. If *remainingElementsCount*.[[Value]] = 0, then
  - a. Let *error* be a newly created **AggregateError** object.
  - b. Perform ! [DefinePropertyOrThrow](#)(*error*, "errors", PropertyDescriptor { [[Configurable]]: **true**, [[Enumerable]]: **false**, [[Writable]]: **true**, [[Value]]: [CreateArrayFromList](#)(*errors*) }).
  - c. Return ? [Call](#)(*promiseCapability*.[[Reject]], **undefined**, « *error* »).
11. Return **undefined**.

The "length" property of a **Promise.any** reject element function is 1<sub>F</sub>.

#### 27.2.4.4 Promise.prototype

The initial value of **Promise.prototype** is the [Promise prototype object](#).

This property has the attributes { [[Writable]]: **false**, [[Enumerable]]: **false**, [[Configurable]]: **false** }.

#### 27.2.4.5 Promise.race ( *iterable* )

This function returns a new promise which is settled in the same way as the first passed promise to settle. It resolves all elements of the passed *iterable* to promises as it runs this algorithm.

1. Let *C* be the **this** value.
2. Let *promiseCapability* be ? [NewPromiseCapability](#)(*C*).
3. Let *promiseResolve* be [Completion](#)([GetPromiseResolve](#)(*C*)).
4. [IfAbruptRejectPromise](#)(*promiseResolve*, *promiseCapability*).
5. Let *iteratorRecord* be [Completion](#)([GetIterator](#)(*iterable*, sync)).
6. [IfAbruptRejectPromise](#)(*iteratorRecord*, *promiseCapability*).
7. Let *result* be [Completion](#)([PerformPromiseRace](#)(*iteratorRecord*, *C*, *promiseCapability*, *promiseResolve*)).
8. If *result* is an [abrupt completion](#), then
  - a. If *iteratorRecord*.[[Done]] is **false**, set *result* to [Completion](#)([IteratorClose](#)(*iteratorRecord*, *result*)).
  - b. [IfAbruptRejectPromise](#)(*result*, *promiseCapability*).
9. Return ? *result*.

NOTE 1 If the *iterable* argument yields no values or if none of the promises yielded by *iterable* ever settle, then the pending promise returned by this method will never be settled.

NOTE 2 This function expects its **this** value to be a [constructor](#) function that supports the parameter conventions of the [Promise constructor](#). It also expects that its **this** value provides a **resolve** method.

#### 27.2.4.5.1 PerformPromiseRace ( *iteratorRecord*, *constructor*, *resultCapability*, *promiseResolve* )

The abstract operation PerformPromiseRace takes arguments *iteratorRecord* (an Iterator Record), *constructor* (a constructor), *resultCapability* (a PromiseCapability Record), and *promiseResolve* (a function object) and returns either a normal completion containing an ECMAScript language value or a throw completion. It performs the following steps when called:

1. Repeat,
  - a. Let *next* be Completion(IteratorStep(*iteratorRecord*)).
  - b. If *next* is an abrupt completion, set *iteratorRecord*.[[Done]] to **true**.
  - c. ReturnIfAbrupt(*next*).
  - d. If *next* is **false**, then
    - i. Set *iteratorRecord*.[[Done]] to **true**.
    - ii. Return *resultCapability*.[[Promise]].
  - e. Let *nextValue* be Completion(IteratorValue(*next*)).
  - f. If *nextValue* is an abrupt completion, set *iteratorRecord*.[[Done]] to **true**.
  - g. ReturnIfAbrupt(*nextValue*).
  - h. Let *nextPromise* be ? Call(*promiseResolve*, *constructor*, « *nextValue* »).
  - i. Perform ? Invoke(*nextPromise*, "then", « *resultCapability*.[[Resolve]], *resultCapability*.[[Reject]] »).

#### 27.2.4.6 Promise.reject ( *r* )

This function returns a new promise rejected with the passed argument.

1. Let *C* be the **this** value.
2. Let *promiseCapability* be ? NewPromiseCapability(*C*).
3. Perform ? Call(*promiseCapability*.[[Reject]], **undefined**, « *r* »).
4. Return *promiseCapability*.[[Promise]].

**NOTE** This function expects its **this** value to be a constructor function that supports the parameter conventions of the Promise constructor.

#### 27.2.4.7 Promise.resolve ( *x* )

This function returns either a new promise resolved with the passed argument, or the argument itself if the argument is a promise produced by this constructor.

1. Let *C* be the **this** value.
2. If *C* is not an Object, throw a **TypeError** exception.
3. Return ? PromiseResolve(*C*, *x*).

**NOTE** This function expects its **this** value to be a constructor function that supports the parameter conventions of the Promise constructor.

##### 27.2.4.7.1 PromiseResolve ( *C*, *x* )

The abstract operation PromiseResolve takes arguments *C* (a constructor) and *x* (an ECMAScript language value) and returns either a normal completion containing an ECMAScript language value or a throw completion. It returns a new promise resolved with *x*. It performs the following steps when called:



1. If `IsPromise(x)` is **true**, then
  - a. Let `xConstructor` be ? `Get(x, "constructor")`.
  - b. If `SameValue(xConstructor, C)` is **true**, return `x`.
2. Let `promiseCapability` be ? `NewPromiseCapability(C)`.
3. Perform ? `Call(promiseCapability.[[Resolve]], undefined, « x »)`.
4. Return `promiseCapability.[[Promise]]`.

#### 27.2.4.8 get Promise [ @@species ]

`Promise[@@species]` is an [accessor property](#) whose set accessor function is **undefined**. Its get accessor function performs the following steps when called:

1. Return the **this** value.

The value of the "name" property of this function is "get [Symbol.species]".

**NOTE** Promise prototype methods normally use their **this** value's [constructor](#) to create a derived object. However, a subclass [constructor](#) may over-ride that default behaviour by redefining its [@@species](#) property.

#### 27.2.5 Properties of the Promise Prototype Object

The *Promise prototype object*:

- is `%Promise.prototype%`.
- has a `[[Prototype]]` internal slot whose value is `%Object.prototype%`.
- is an [ordinary object](#).
- does not have a `[[PromiseState]]` internal slot or any of the other internal slots of Promise instances.

##### 27.2.5.1 Promise.prototype.catch ( *onRejected* )

This method performs the following steps when called:

1. Let `promise` be the **this** value.
2. Return ? `Invoke(promise, "then", « undefined, onRejected »)`.

##### 27.2.5.2 Promise.prototype.constructor

The initial value of `Promise.prototype.constructor` is `%Promise%`.

##### 27.2.5.3 Promise.prototype.finally ( *onFinally* )

This method performs the following steps when called:

1. Let `promise` be the **this** value.
2. If `promise` is not an [Object](#), throw a **TypeError** exception.
3. Let `C` be ? `SpeciesConstructor(promise, %Promise%)`.
4. **Assert**: `IsConstructor(C)` is **true**.
5. If `IsCallable(onFinally)` is **false**, then
  - a. Let `thenFinally` be `onFinally`.
  - b. Let `catchFinally` be `onFinally`.

6. Else,
  - a. Let *thenFinallyClosure* be a new **Abstract Closure** with parameters (*value*) that captures *onFinally* and *C* and performs the following steps when called:
    - i. Let *result* be ? **Call**(*onFinally*, **undefined**).
    - ii. Let *p* be ? **PromiseResolve**(*C*, *result*).
    - iii. Let *returnValue* be a new **Abstract Closure** with no parameters that captures *value* and performs the following steps when called:
      1. Return *value*.
    - iv. Let *valueThunk* be **CreateBuiltinFunction**(*returnValue*, 0, "", « »).
    - v. Return ? **Invoke**(*p*, "then", « *valueThunk* »).
  - b. Let *thenFinally* be **CreateBuiltinFunction**(*thenFinallyClosure*, 1, "", « »).
  - c. Let *catchFinallyClosure* be a new **Abstract Closure** with parameters (*reason*) that captures *onFinally* and *C* and performs the following steps when called:
    - i. Let *result* be ? **Call**(*onFinally*, **undefined**).
    - ii. Let *p* be ? **PromiseResolve**(*C*, *result*).
    - iii. Let *throwReason* be a new **Abstract Closure** with no parameters that captures *reason* and performs the following steps when called:
      1. Return **ThrowCompletion**(*reason*).
    - iv. Let *thrower* be **CreateBuiltinFunction**(*throwReason*, 0, "", « »).
    - v. Return ? **Invoke**(*p*, "then", « *thrower* »).
  - d. Let *catchFinally* be **CreateBuiltinFunction**(*catchFinallyClosure*, 1, "", « »).
7. Return ? **Invoke**(*promise*, "then", « *thenFinally*, *catchFinally* »).

#### 27.2.5.4 Promise.prototype.then ( *onFulfilled*, *onRejected* )

This method performs the following steps when called:

1. Let *promise* be the **this** value.
2. If **IsPromise**(*promise*) is **false**, throw a **TypeError** exception.
3. Let *C* be ? **SpeciesConstructor**(*promise*, %Promise%).
4. Let *resultCapability* be ? **NewPromiseCapability**(*C*).
5. Return **PerformPromiseThen**(*promise*, *onFulfilled*, *onRejected*, *resultCapability*).

##### 27.2.5.4.1 PerformPromiseThen ( *promise*, *onFulfilled*, *onRejected* [ , *resultCapability* ] )

The abstract operation **PerformPromiseThen** takes arguments *promise* (a Promise), *onFulfilled* (an ECMAScript language value), and *onRejected* (an ECMAScript language value) and optional argument *resultCapability* (a PromiseCapability Record) and returns an ECMAScript language value. It performs the “then” operation on *promise* using *onFulfilled* and *onRejected* as its settlement actions. If *resultCapability* is passed, the result is stored by updating *resultCapability*’s promise. If it is not passed, then **PerformPromiseThen** is being called by a specification-internal operation where the result does not matter. It performs the following steps when called:

1. **Assert**: **IsPromise**(*promise*) is **true**.
2. If *resultCapability* is not present, then
  - a. Set *resultCapability* to **undefined**.
3. If **IsCallable**(*onFulfilled*) is **false**, then
  - a. Let *onFulfilledJobCallback* be empty.
4. Else,
  - a. Let *onFulfilledJobCallback* be **HostMakeJobCallback**(*onFulfilled*).
5. If **IsCallable**(*onRejected*) is **false**, then
  - a. Let *onRejectedJobCallback* be empty.
6. Else,

- a. Let *onRejectedJobCallback* be `HostMakeJobCallback(onRejected)`.
7. Let *fulfillReaction* be the PromiseReaction { `[[Capability]]`: *resultCapability*, `[[Type]]`: Fulfill, `[[Handler]]`: *onFulfilledJobCallback* }.
8. Let *rejectReaction* be the PromiseReaction { `[[Capability]]`: *resultCapability*, `[[Type]]`: Reject, `[[Handler]]`: *onRejectedJobCallback* }.
9. If *promise*.`[[PromiseState]]` is pending, then
  - a. Append *fulfillReaction* to *promise*.`[[PromiseFulfillReactions]]`.
  - b. Append *rejectReaction* to *promise*.`[[PromiseRejectReactions]]`.
10. Else if *promise*.`[[PromiseState]]` is fulfilled, then
  - a. Let *value* be *promise*.`[[PromiseResult]]`.
  - b. Let *fulfillJob* be `NewPromiseReactionJob(fulfillReaction, value)`.
  - c. Perform `HostEnqueuePromiseJob(fulfillJob.[[Job]], fulfillJob.[[Realm]])`.
11. Else,
  - a. **Assert**: The value of *promise*.`[[PromiseState]]` is rejected.
  - b. Let *reason* be *promise*.`[[PromiseResult]]`.
  - c. If *promise*.`[[PromiselsHandled]]` is **false**, perform `HostPromiseRejectionTracker(promise, "handle")`.
  - d. Let *rejectJob* be `NewPromiseReactionJob(rejectReaction, reason)`.
  - e. Perform `HostEnqueuePromiseJob(rejectJob.[[Job]], rejectJob.[[Realm]])`.
12. Set *promise*.`[[PromiselsHandled]]` to **true**.
13. If *resultCapability* is **undefined**, then
  - a. Return **undefined**.
14. Else,
  - a. Return *resultCapability*.`[[Promise]]`.

### 27.2.5.5 Promise.prototype [ @@toStringTag ]

The initial value of the `@@toStringTag` property is the String value **"Promise"**.

This property has the attributes { `[[Writable]]`: **false**, `[[Enumerable]]`: **false**, `[[Configurable]]`: **true** }.

### 27.2.6 Properties of Promise Instances

Promise instances are **ordinary objects** that inherit properties from the **Promise prototype object** (the intrinsic, `%Promise.prototype%`). Promise instances are initially created with the internal slots described in [Table 81](#).

**Table 81: Internal Slots of Promise Instances**

Internal Slot	Type	Description
<code>[[PromiseState]]</code>	pending, fulfilled, or rejected	Governs how a promise will react to incoming calls to its <b>then</b> method.
<code>[[PromiseResult]]</code>	an <b>ECMAScript language value</b>	The value with which the promise has been fulfilled or rejected, if any. Only meaningful if <code>[[PromiseState]]</code> is not pending.
<code>[[PromiseFulfillReactions]]</code>	a <b>List</b> of <b>PromiseReaction Records</b>	<b>Records</b> to be processed when/if the promise transitions from the pending state to the fulfilled state.
<code>[[PromiseRejectReactions]]</code>	a <b>List</b> of <b>PromiseReaction Records</b>	<b>Records</b> to be processed when/if the promise transitions from the pending state to the rejected state.

Table 81 (continued)

Internal Slot	Type	Description
[[PromisesHandled]]	a Boolean	Indicates whether the promise has ever had a fulfillment or rejection handler; used in unhandled rejection tracking.

## 27.3 GeneratorFunction Objects

GeneratorFunctions are functions that are usually created by evaluating *GeneratorDeclarations*, *GeneratorExpressions*, and *GeneratorMethods*. They may also be created by calling the `%GeneratorFunction%` intrinsic.

Figure 6 (Informative): Generator Objects Relationships

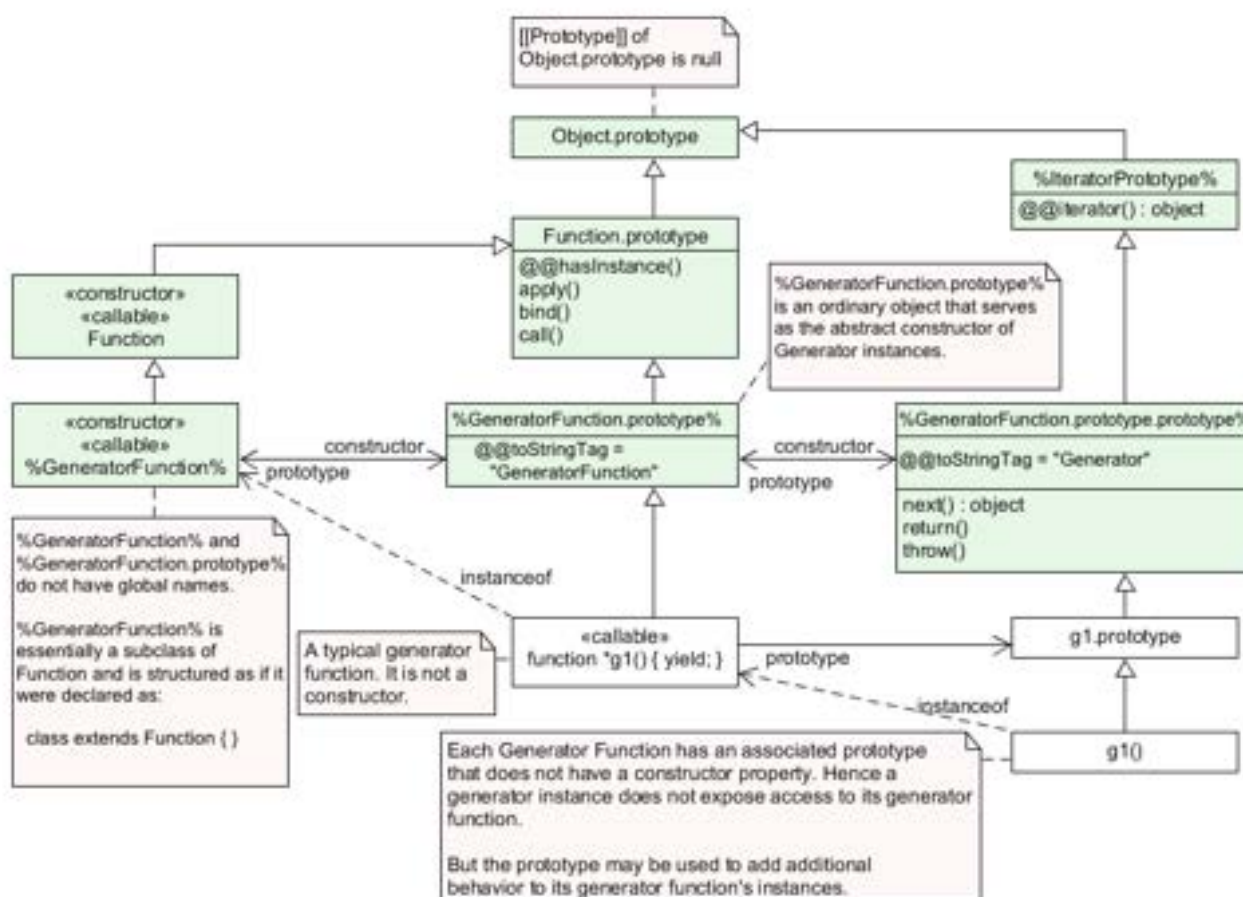

### 27.3.1 The GeneratorFunction Constructor

The `GeneratorFunction` constructor:

- is `%GeneratorFunction%`.
- is a subclass of `Function`.
- creates and initializes a new `GeneratorFunction` when called as a function rather than as a `constructor`. Thus the function call `GeneratorFunction (...)` is equivalent to the object creation expression `new GeneratorFunction (...)` with the same arguments.
- may be used as the value of an `extends` clause of a class definition. Subclass `constructors` that intend to inherit the specified `GeneratorFunction` behaviour must include a `super` call to the `GeneratorFunction constructor` to create and initialize subclass instances with the internal slots necessary for built-in

GeneratorFunction behaviour. All ECMAScript syntactic forms for defining generator [function objects](#) create direct instances of GeneratorFunction. There is no syntactic means to create instances of GeneratorFunction subclasses.

### 27.3.1.1 GeneratorFunction ( ...*parameterArgs*, *bodyArg* )

The last argument (if any) specifies the body (executable code) of a generator function; any preceding arguments specify formal parameters.

This function performs the following steps when called:

1. Let *C* be the [active function object](#).
2. If *bodyArg* is not present, set *bodyArg* to the empty String.
3. Return ? [CreateDynamicFunction](#)(*C*, NewTarget, generator, *parameterArgs*, *bodyArg*).

NOTE See NOTE for [20.2.1.1](#).

## 27.3.2 Properties of the GeneratorFunction Constructor

The GeneratorFunction [constructor](#):

- is a standard built-in [function object](#) that inherits from the Function [constructor](#).
- has a [\[\[Prototype\]\]](#) internal slot whose value is [%Function%](#).
- has a "name" property whose value is "GeneratorFunction".
- has the following properties:

### 27.3.2.1 GeneratorFunction.length

This is a [data property](#) with a value of 1. This property has the attributes { [\[\[Writable\]\]](#): **false**, [\[\[Enumerable\]\]](#): **false**, [\[\[Configurable\]\]](#): **true** }.

### 27.3.2.2 GeneratorFunction.prototype

The initial value of [GeneratorFunction.prototype](#) is the [GeneratorFunction prototype object](#).

This property has the attributes { [\[\[Writable\]\]](#): **false**, [\[\[Enumerable\]\]](#): **false**, [\[\[Configurable\]\]](#): **false** }.

## 27.3.3 Properties of the GeneratorFunction Prototype Object

The *GeneratorFunction prototype object*:

- is [%GeneratorFunction.prototype%](#) (see [Figure 6](#)).
- is an [ordinary object](#).
- is not a [function object](#) and does not have an [\[\[ECMAScriptCode\]\]](#) internal slot or any other of the internal slots listed in [Table 30](#) or [Table 82](#).
- has a [\[\[Prototype\]\]](#) internal slot whose value is [%Function.prototype%](#).

### 27.3.3.1 GeneratorFunction.prototype.constructor

The initial value of [GeneratorFunction.prototype.constructor](#) is [%GeneratorFunction%](#).

This property has the attributes { [\[\[Writable\]\]](#): **false**, [\[\[Enumerable\]\]](#): **false**, [\[\[Configurable\]\]](#): **true** }.

### 27.3.3.2 GeneratorFunction.prototype.prototype

The initial value of `GeneratorFunction.prototype.prototype` is the [Generator prototype object](#).

This property has the attributes { `[[Writable]]`: **false**, `[[Enumerable]]`: **false**, `[[Configurable]]`: **true** }.

### 27.3.3.3 GeneratorFunction.prototype [ @@toStringTag ]

The initial value of the `@@toStringTag` property is the String value **"GeneratorFunction"**.

This property has the attributes { `[[Writable]]`: **false**, `[[Enumerable]]`: **false**, `[[Configurable]]`: **true** }.

## 27.3.4 GeneratorFunction Instances

Every `GeneratorFunction` instance is an ECMAScript [function object](#) and has the internal slots listed in [Table 30](#). The value of the `[[IsClassConstructor]]` internal slot for all such instances is **false**.

Each `GeneratorFunction` instance has the following own properties:

### 27.3.4.1 length

The specification for the **"length"** property of `Function` instances given in [20.2.4.1](#) also applies to `GeneratorFunction` instances.

### 27.3.4.2 name

The specification for the **"name"** property of `Function` instances given in [20.2.4.2](#) also applies to `GeneratorFunction` instances.

### 27.3.4.3 prototype

Whenever a `GeneratorFunction` instance is created another [ordinary object](#) is also created and is the initial value of the generator function's **"prototype"** property. The value of the `prototype` property is used to initialize the `[[Prototype]]` internal slot of a newly created `Generator` when the generator [function object](#) is invoked using `[[Call]]`.

This property has the attributes { `[[Writable]]`: **true**, `[[Enumerable]]`: **false**, `[[Configurable]]`: **false** }.

**NOTE** Unlike `Function` instances, the object that is the value of a `GeneratorFunction`'s **"prototype"** property does not have a **"constructor"** property whose value is the `GeneratorFunction` instance.

## 27.4 AsyncGeneratorFunction Objects

`AsyncGeneratorFunctions` are functions that are usually created by evaluating *AsyncGeneratorDeclaration*, *AsyncGeneratorExpression*, and *AsyncGeneratorMethod* syntactic productions. They may also be created by calling the `%AsyncGeneratorFunction%` intrinsic.

## 27.4.1 The AsyncGeneratorFunction Constructor

The AsyncGeneratorFunction [constructor](#):

- is `%AsyncGeneratorFunction%`.
- is a subclass of `Function`.
- creates and initializes a new AsyncGeneratorFunction when called as a function rather than as a [constructor](#). Thus the function call `AsyncGeneratorFunction (...)` is equivalent to the object creation expression `new AsyncGeneratorFunction (...)` with the same arguments.
- may be used as the value of an `extends` clause of a class definition. Subclass [constructors](#) that intend to inherit the specified AsyncGeneratorFunction behaviour must include a `super` call to the AsyncGeneratorFunction [constructor](#) to create and initialize subclass instances with the internal slots necessary for built-in AsyncGeneratorFunction behaviour. All ECMAScript syntactic forms for defining async generator [function objects](#) create direct instances of AsyncGeneratorFunction. There is no syntactic means to create instances of AsyncGeneratorFunction subclasses.

### 27.4.1.1 AsyncGeneratorFunction ( ...*parameterArgs*, *bodyArg* )

The last argument (if any) specifies the body (executable code) of an async generator function; any preceding arguments specify formal parameters.

This function performs the following steps when called:

1. Let *C* be the [active function object](#).
2. If *bodyArg* is not present, set *bodyArg* to the empty String.
3. Return ? [CreateDynamicFunction](#)(*C*, NewTarget, `asyncGenerator`, *parameterArgs*, *bodyArg*).

NOTE See NOTE for [20.2.1.1](#).

## 27.4.2 Properties of the AsyncGeneratorFunction Constructor

The AsyncGeneratorFunction [constructor](#):

- is a standard built-in [function object](#) that inherits from the `Function` [constructor](#).
- has a `[[Prototype]]` internal slot whose value is `%Function%`.
- has a `"name"` property whose value is `"AsyncGeneratorFunction"`.
- has the following properties:

### 27.4.2.1 AsyncGeneratorFunction.length

This is a [data property](#) with a value of 1. This property has the attributes { `[[Writable]]`: `false`, `[[Enumerable]]`: `false`, `[[Configurable]]`: `true` }.

### 27.4.2.2 AsyncGeneratorFunction.prototype

The initial value of `AsyncGeneratorFunction.prototype` is the [AsyncGeneratorFunction prototype object](#).

This property has the attributes { `[[Writable]]`: `false`, `[[Enumerable]]`: `false`, `[[Configurable]]`: `false` }.

## 27.4.3 Properties of the AsyncGeneratorFunction Prototype Object

The *AsyncGeneratorFunction prototype object*:

- is `%AsyncGeneratorFunction.prototype%`.
- is an [ordinary object](#).
- is not a [function object](#) and does not have an `[[ECMAScriptCode]]` internal slot or any other of the internal slots listed in [Table 30](#) or [Table 83](#).
- has a `[[Prototype]]` internal slot whose value is `%Function.prototype%`.

### 27.4.3.1 `AsyncGeneratorFunction.prototype.constructor`

The initial value of `AsyncGeneratorFunction.prototype.constructor` is `%AsyncGeneratorFunction%`.

This property has the attributes { `[[Writable]]`: **false**, `[[Enumerable]]`: **false**, `[[Configurable]]`: **true** }.

### 27.4.3.2 `AsyncGeneratorFunction.prototype.prototype`

The initial value of `AsyncGeneratorFunction.prototype.prototype` is the [AsyncGenerator prototype object](#).

This property has the attributes { `[[Writable]]`: **false**, `[[Enumerable]]`: **false**, `[[Configurable]]`: **true** }.

### 27.4.3.3 `AsyncGeneratorFunction.prototype [ @@toStringTag ]`

The initial value of the `@@toStringTag` property is the String value `"AsyncGeneratorFunction"`.

This property has the attributes { `[[Writable]]`: **false**, `[[Enumerable]]`: **false**, `[[Configurable]]`: **true** }.

## 27.4.4 `AsyncGeneratorFunction` Instances

Every `AsyncGeneratorFunction` instance is an ECMAScript [function object](#) and has the internal slots listed in [Table 30](#). The value of the `[[IsClassConstructor]]` internal slot for all such instances is **false**.

Each `AsyncGeneratorFunction` instance has the following own properties:

### 27.4.4.1 `length`

The value of the `"length"` property is an [integral Number](#) that indicates the typical number of arguments expected by the `AsyncGeneratorFunction`. However, the language permits the function to be invoked with some other number of arguments. The behaviour of an `AsyncGeneratorFunction` when invoked on a number of arguments other than the number specified by its `"length"` property depends on the function.

This property has the attributes { `[[Writable]]`: **false**, `[[Enumerable]]`: **false**, `[[Configurable]]`: **true** }.

### 27.4.4.2 `name`

The specification for the `"name"` property of Function instances given in [20.2.4.2](#) also applies to `AsyncGeneratorFunction` instances.

### 27.4.4.3 `prototype`

Whenever an `AsyncGeneratorFunction` instance is created, another [ordinary object](#) is also created and is the initial value of the async generator function's `"prototype"` property. The value of the prototype property is used to initialize the `[[Prototype]]` internal slot of a newly created `AsyncGenerator` when the generator [function object](#) is invoked using `[[Call]]`.



This property has the attributes { `[[Writable]]`: **true**, `[[Enumerable]]`: **false**, `[[Configurable]]`: **false** }.

**NOTE** Unlike function instances, the object that is the value of an AsyncGeneratorFunction's **"prototype"** property does not have a **"constructor"** property whose value is the AsyncGeneratorFunction instance.

## 27.5 Generator Objects

A Generator is an instance of a generator function and conforms to both the *Iterator* and *Iterable* interfaces.

Generator instances directly inherit properties from the object that is the initial value of the **"prototype"** property of the Generator function that created the instance. Generator instances indirectly inherit properties from the Generator Prototype intrinsic, `%GeneratorFunction.prototype.prototype%`.

### 27.5.1 Properties of the Generator Prototype Object

The *Generator prototype object*:

- is `%GeneratorFunction.prototype.prototype%`.
- is an [ordinary object](#).
- is not a Generator instance and does not have a `[[GeneratorState]]` internal slot.
- has a `[[Prototype]]` internal slot whose value is `%IteratorPrototype%`.
- has properties that are indirectly inherited by all Generator instances.

#### 27.5.1.1 Generator.prototype.constructor

The initial value of `Generator.prototype.constructor` is `%GeneratorFunction.prototype%`.

This property has the attributes { `[[Writable]]`: **false**, `[[Enumerable]]`: **false**, `[[Configurable]]`: **true** }.

#### 27.5.1.2 Generator.prototype.next ( *value* )

1. Return ? `GeneratorResume`(**this** value, *value*, empty).

#### 27.5.1.3 Generator.prototype.return ( *value* )

This method performs the following steps when called:

1. Let *g* be the **this** value.
2. Let *C* be `Completion Record` { `[[Type]]`: `return`, `[[Value]]`: *value*, `[[Target]]`: empty }.
3. Return ? `GeneratorResumeAbrupt`(*g*, *C*, empty).

#### 27.5.1.4 Generator.prototype.throw ( *exception* )

This method performs the following steps when called:

1. Let *g* be the **this** value.
2. Let *C* be `ThrowCompletion`(*exception*).
3. Return ? `GeneratorResumeAbrupt`(*g*, *C*, empty).

### 27.5.1.5 Generator.prototype [ @@toStringTag ]

The initial value of the @@toStringTag property is the String value "Generator".

This property has the attributes { [[Writable]]: false, [[Enumerable]]: false, [[Configurable]]: true }.

### 27.5.2 Properties of Generator Instances

Generator instances are initially created with the internal slots described in Table 82.

Table 82: Internal Slots of Generator Instances

Internal Slot	Type	Description
[[GeneratorState]]	undefined, suspendedStart, suspendedYield, executing, or completed	The current execution state of the generator.
[[GeneratorContext]]	an execution context	The execution context that is used when executing the code of this generator.
[[GeneratorBrand]]	a String or empty	A brand used to distinguish different kinds of generators. The [[GeneratorBrand]] of generators declared by ECMAScript source text is always empty.

### 27.5.3 Generator Abstract Operations

#### 27.5.3.1 GeneratorStart ( generator, generatorBody )

The abstract operation GeneratorStart takes arguments generator (a Generator) and generatorBody (a FunctionBody Parse Node or an Abstract Closure with no parameters) and returns unused. It performs the following steps when called:

1. **Assert**: The value of generator.[[GeneratorState]] is **undefined**.
2. Let genContext be the running execution context.
3. Set the Generator component of genContext to generator.
4. Let closure be a new Abstract Closure with no parameters that captures generatorBody and performs the following steps when called:
  - a. Let acGenContext be the running execution context.
  - b. Let acGenerator be the Generator component of acGenContext.
  - c. If generatorBody is a Parse Node, then
    - i. Let result be Completion(Evaluation of generatorBody).
  - d. Else,
    - i. **Assert**: generatorBody is an Abstract Closure with no parameters.
    - ii. Let result be generatorBody().
- e. **Assert**: If we return here, the generator either threw an exception or performed either an implicit or explicit return.
- f. Remove acGenContext from the execution context stack and restore the execution context that is at the top of the execution context stack as the running execution context.
- g. Set acGenerator.[[GeneratorState]] to completed.
- h. **NOTE**: Once a generator enters the completed state it never leaves it and its associated execution context is never resumed. Any execution state associated with acGenerator can be

- discarded at this point.
- i. If *result*.[[Type]] is normal, let *resultValue* be **undefined**.
  - j. Else if *result*.[[Type]] is return, let *resultValue* be *result*.[[Value]].
  - k. Else,
    - i. **Assert**: *result*.[[Type]] is throw.
    - ii. Return ? *result*.
  - l. Return *CreateIterResultObject*(*resultValue*, **true**).
5. Set the code evaluation state of *genContext* such that when evaluation is resumed for that *execution context*, *closure* will be called with no arguments.
  6. Set *generator*.[[GeneratorContext]] to *genContext*.
  7. Set *generator*.[[GeneratorState]] to *suspendedStart*.
  8. Return unused.

### 27.5.3.2 GeneratorValidate ( *generator*, *generatorBrand* )

The abstract operation *GeneratorValidate* takes arguments *generator* (an ECMAScript language value) and *generatorBrand* (a String or empty) and returns either a *normal completion* containing one of *suspendedStart*, *suspendedYield*, or *completed*, or a *throw completion*. It performs the following steps when called:

1. Perform ? *RequireInternalSlot*(*generator*, [[GeneratorState]]).
2. Perform ? *RequireInternalSlot*(*generator*, [[GeneratorBrand]]).
3. If *generator*.[[GeneratorBrand]] is not *generatorBrand*, throw a **TypeError** exception.
4. **Assert**: *generator* also has a [[GeneratorContext]] internal slot.
5. Let *state* be *generator*.[[GeneratorState]].
6. If *state* is executing, throw a **TypeError** exception.
7. Return *state*.

### 27.5.3.3 GeneratorResume ( *generator*, *value*, *generatorBrand* )

The abstract operation *GeneratorResume* takes arguments *generator* (an ECMAScript language value), *value* (an ECMAScript language value or empty), and *generatorBrand* (a String or empty) and returns either a *normal completion* containing an ECMAScript language value or a *throw completion*. It performs the following steps when called:

1. Let *state* be ? *GeneratorValidate*(*generator*, *generatorBrand*).
2. If *state* is completed, return *CreateIterResultObject*(**undefined**, **true**).
3. **Assert**: *state* is either *suspendedStart* or *suspendedYield*.
4. Let *genContext* be *generator*.[[GeneratorContext]].
5. Let *methodContext* be the *running execution context*.
6. Suspend *methodContext*.
7. Set *generator*.[[GeneratorState]] to *executing*.
8. Push *genContext* onto the *execution context stack*; *genContext* is now the *running execution context*.
9. Resume the suspended evaluation of *genContext* using *NormalCompletion*(*value*) as the result of the operation that suspended it. Let *result* be the value returned by the resumed computation.
10. **Assert**: When we return here, *genContext* has already been removed from the *execution context stack* and *methodContext* is the currently *running execution context*.
11. Return ? *result*.

#### 27.5.3.4 GeneratorResumeAbrupt ( *generator*, *abruptCompletion*, *generatorBrand* )

The abstract operation GeneratorResumeAbrupt takes arguments *generator* (an ECMAScript language value), *abruptCompletion* (a return completion or a throw completion), and *generatorBrand* (a String or empty) and returns either a normal completion containing an ECMAScript language value or a throw completion. It performs the following steps when called:

1. Let *state* be ? [GeneratorValidate\(generator, generatorBrand\)](#).
2. If *state* is suspendedStart, then
  - a. Set *generator*.[[GeneratorState]] to completed.
  - b. NOTE: Once a generator enters the completed state it never leaves it and its associated execution context is never resumed. Any execution state associated with *generator* can be discarded at this point.
  - c. Set *state* to completed.
3. If *state* is completed, then
  - a. If *abruptCompletion*.[[Type]] is return, then
    - i. Return [CreateIterResultObject\(abruptCompletion.\[\[Value\]\], true\)](#).
  - b. Return ? *abruptCompletion*.
4. **Assert:** *state* is suspendedYield.
5. Let *genContext* be *generator*.[[GeneratorContext]].
6. Let *methodContext* be the running execution context.
7. Suspend *methodContext*.
8. Set *generator*.[[GeneratorState]] to executing.
9. Push *genContext* onto the execution context stack; *genContext* is now the running execution context.
10. Resume the suspended evaluation of *genContext* using *abruptCompletion* as the result of the operation that suspended it. Let *result* be the Completion Record returned by the resumed computation.
11. **Assert:** When we return here, *genContext* has already been removed from the execution context stack and *methodContext* is the currently running execution context.
12. Return ? *result*.

#### 27.5.3.5 GetGeneratorKind ( )

The abstract operation GetGeneratorKind takes no arguments and returns non-generator, sync, or async. It performs the following steps when called:

1. Let *genContext* be the running execution context.
2. If *genContext* does not have a Generator component, return non-generator.
3. Let *generator* be the Generator component of *genContext*.
4. If *generator* has an [[AsyncGeneratorState]] internal slot, return async.
5. Else, return sync.

#### 27.5.3.6 GeneratorYield ( *iterNextObj* )

The abstract operation GeneratorYield takes argument *iterNextObj* (an Object that conforms to the *IteratorResult* interface) and returns either a normal completion containing an ECMAScript language value or an abrupt completion. It performs the following steps when called:

1. Let *genContext* be the running execution context.
2. **Assert:** *genContext* is the execution context of a generator.
3. Let *generator* be the value of the Generator component of *genContext*.
4. **Assert:** [GetGeneratorKind\(\)](#) is sync.

5. Set *generator*.[[GeneratorState]] to suspendedYield.
6. Remove *genContext* from the *execution context stack* and restore the *execution context* that is at the top of the *execution context stack* as the *running execution context*.
7. Let *callerContext* be the *running execution context*.
8. Resume *callerContext* passing *NormalCompletion(iterNextObj)*. If *genContext* is ever resumed again, let *resumptionValue* be the *Completion Record* with which it is resumed.
9. **Assert**: If control reaches here, then *genContext* is the *running execution context* again.
10. Return *resumptionValue*.

### 27.5.3.7 Yield ( *value* )

The abstract operation Yield takes argument *value* (an ECMAScript language value) and returns either a *normal completion containing* an ECMAScript language value or an *abrupt completion*. It performs the following steps when called:

1. Let *generatorKind* be *GetGeneratorKind()*.
2. If *generatorKind* is *async*, return ? *AsyncGeneratorYield(? Await(value))*.
3. Otherwise, return ? *GeneratorYield(CreateIterResultObject(value, false))*.

### 27.5.3.8 CreateIteratorFromClosure ( *closure*, *generatorBrand*, *generatorPrototype* )

The abstract operation CreateIteratorFromClosure takes arguments *closure* (an *Abstract Closure* with no parameters), *generatorBrand* (a String or empty), and *generatorPrototype* (an Object) and returns a Generator. It performs the following steps when called:

1. NOTE: *closure* can contain uses of the *Yield* operation to yield an *IteratorResult* object.
2. Let *internalSlotsList* be « [[GeneratorState]], [[GeneratorContext]], [[GeneratorBrand]] ».
3. Let *generator* be *OrdinaryObjectCreate(generatorPrototype, internalSlotsList)*.
4. Set *generator*.[[GeneratorBrand]] to *generatorBrand*.
5. Set *generator*.[[GeneratorState]] to **undefined**.
6. Let *callerContext* be the *running execution context*.
7. Let *calleeContext* be a new *execution context*.
8. Set the Function of *calleeContext* to **null**.
9. Set the *Realm* of *calleeContext* to the *current Realm Record*.
10. Set the *ScriptOrModule* of *calleeContext* to *callerContext*'s *ScriptOrModule*.
11. If *callerContext* is not already suspended, suspend *callerContext*.
12. Push *calleeContext* onto the *execution context stack*; *calleeContext* is now the *running execution context*.
13. Perform *GeneratorStart(generator, closure)*.
14. Remove *calleeContext* from the *execution context stack* and restore *callerContext* as the *running execution context*.
15. Return *generator*.

## 27.6 AsyncGenerator Objects

An AsyncGenerator is an instance of an async generator function and conforms to both the AsyncIterator and AsyncIterable interfaces.

AsyncGenerator instances directly inherit properties from the object that is the initial value of the **"prototype"** property of the AsyncGenerator function that created the instance. AsyncGenerator instances indirectly inherit properties from the AsyncGenerator Prototype intrinsic, `%AsyncGeneratorFunction.prototype.prototype%`.

## 27.6.1 Properties of the AsyncGenerator Prototype Object

The *AsyncGenerator* prototype object:

- is *%AsyncGeneratorFunction.prototype.prototype%*.
- is an *ordinary object*.
- is not an AsyncGenerator instance and does not have an *[[AsyncGeneratorState]]* internal slot.
- has a *[[Prototype]]* internal slot whose value is *%AsyncIteratorPrototype%*.
- has properties that are indirectly inherited by all AsyncGenerator instances.

### 27.6.1.1 AsyncGenerator.prototype.constructor

The initial value of *AsyncGenerator.prototype.constructor* is *%AsyncGeneratorFunction.prototype%*.

This property has the attributes { *[[Writable]]*: **false**, *[[Enumerable]]*: **false**, *[[Configurable]]*: **true** }.

### 27.6.1.2 AsyncGenerator.prototype.next ( *value* )

1. Let *generator* be the **this** value.
2. Let *promiseCapability* be ! *NewPromiseCapability*(*%Promise%*).
3. Let *result* be *Completion*(*AsyncGeneratorValidate*(*generator*, empty)).
4. *IfAbruptRejectPromise*(*result*, *promiseCapability*).
5. Let *state* be *generator*.*[[AsyncGeneratorState]]*.
6. If *state* is completed, then
  - a. Let *iteratorResult* be *CreateIterResultObject*(**undefined**, **true**).
  - b. Perform ! *Call*(*promiseCapability*.*[[Resolve]]*, **undefined**, « *iteratorResult* »).
  - c. Return *promiseCapability*.*[[Promise]]*.
7. Let *completion* be *NormalCompletion*(*value*).
8. Perform *AsyncGeneratorEnqueue*(*generator*, *completion*, *promiseCapability*).
9. If *state* is either *suspendedStart* or *suspendedYield*, then
  - a. Perform *AsyncGeneratorResume*(*generator*, *completion*).
10. Else,
  - a. **Assert**: *state* is either *executing* or *awaiting-return*.
11. Return *promiseCapability*.*[[Promise]]*.

### 27.6.1.3 AsyncGenerator.prototype.return ( *value* )

1. Let *generator* be the **this** value.
2. Let *promiseCapability* be ! *NewPromiseCapability*(*%Promise%*).
3. Let *result* be *Completion*(*AsyncGeneratorValidate*(*generator*, empty)).
4. *IfAbruptRejectPromise*(*result*, *promiseCapability*).
5. Let *completion* be *Completion Record* { *[[Type]]*: **return**, *[[Value]]*: *value*, *[[Target]]*: empty }.
6. Perform *AsyncGeneratorEnqueue*(*generator*, *completion*, *promiseCapability*).
7. Let *state* be *generator*.*[[AsyncGeneratorState]]*.
8. If *state* is either *suspendedStart* or *completed*, then
  - a. Set *generator*.*[[AsyncGeneratorState]]* to *awaiting-return*.
  - b. Perform ! *AsyncGeneratorAwaitReturn*(*generator*).
9. Else if *state* is *suspendedYield*, then
  - a. Perform *AsyncGeneratorResume*(*generator*, *completion*).
10. Else,

- a. **Assert:** *state* is either executing or awaiting-return.
- 11. Return *promiseCapability*.[[Promise]].

#### 27.6.1.4 AsyncGenerator.prototype.throw ( *exception* )

1. Let *generator* be the **this** value.
2. Let *promiseCapability* be ! **NewPromiseCapability**(%Promise%).
3. Let *result* be **Completion**(**AsyncGeneratorValidate**(*generator*, empty)).
4. **IfAbruptRejectPromise**(*result*, *promiseCapability*).
5. Let *state* be *generator*.[[AsyncGeneratorState]].
6. If *state* is suspendedStart, then
  - a. Set *generator*.[[AsyncGeneratorState]] to completed.
  - b. Set *state* to completed.
7. If *state* is completed, then
  - a. Perform ! **Call**(*promiseCapability*.[[Reject]], **undefined**, « *exception* »).
  - b. Return *promiseCapability*.[[Promise]].
8. Let *completion* be **ThrowCompletion**(*exception*).
9. Perform **AsyncGeneratorEnqueue**(*generator*, *completion*, *promiseCapability*).
10. If *state* is suspendedYield, then
  - a. Perform **AsyncGeneratorResume**(*generator*, *completion*).
11. Else,
  - a. **Assert:** *state* is either executing or awaiting-return.
12. Return *promiseCapability*.[[Promise]].

#### 27.6.1.5 AsyncGenerator.prototype [ @@toStringTag ]

The initial value of the @@toStringTag property is the String value "AsyncGenerator".

This property has the attributes { [[Writable]]: **false**, [[Enumerable]]: **false**, [[Configurable]]: **true** }.

### 27.6.2 Properties of AsyncGenerator Instances

AsyncGenerator instances are initially created with the internal slots described below:

**Table 83: Internal Slots of AsyncGenerator Instances**

Internal Slot	Type	Description
[[AsyncGeneratorState]]	<b>undefined</b> , suspendedStart, suspendedYield, executing, awaiting-return, or completed	The current execution state of the async generator.
[[AsyncGeneratorContext]]	an <b>execution context</b>	The <b>execution context</b> that is used when executing the code of this async generator.
[[AsyncGeneratorQueue]]	a <b>List of AsyncGeneratorRequest Records</b>	<b>Records</b> which represent requests to resume the async generator. Except during state transitions, it is non-empty if and only if [[AsyncGeneratorState]] is either executing or awaiting-return.
[[GeneratorBrand]]	a String or empty	A brand used to distinguish different kinds of async generators. The [[GeneratorBrand]] of async generators declared by <b>ECMAScript source text</b> is always empty.

## 27.6.3 AsyncGenerator Abstract Operations

### 27.6.3.1 AsyncGeneratorRequest Records

An *AsyncGeneratorRequest* is a **Record** value used to store information about how an async generator should be resumed and contains capabilities for fulfilling or rejecting the corresponding promise.

They have the following fields:

Table 84: AsyncGeneratorRequest **Record** Fields

Field Name	Value	Meaning
[[Completion]]	a <b>Completion Record</b>	The <b>Completion Record</b> which should be used to resume the async generator.
[[Capability]]	a <b>PromiseCapability Record</b>	The promise capabilities associated with this request.

### 27.6.3.2 AsyncGeneratorStart ( *generator*, *generatorBody* )

The abstract operation *AsyncGeneratorStart* takes arguments *generator* (an *AsyncGenerator*) and *generatorBody* (a *FunctionBody Parse Node* or an *Abstract Closure* with no parameters) and returns unused. It performs the following steps when called:

1. **Assert:** *generator*.[[AsyncGeneratorState]] is **undefined**.
2. Let *genContext* be the **running execution context**.
3. Set the Generator component of *genContext* to *generator*.
4. Let *closure* be a new **Abstract Closure** with no parameters that captures *generatorBody* and performs the following steps when called:
  - a. Let *acGenContext* be the **running execution context**.
  - b. Let *acGenerator* be the Generator component of *acGenContext*.
  - c. If *generatorBody* is a **Parse Node**, then
    - i. Let *result* be **Completion**(Evaluation of *generatorBody*).
  - d. Else,
    - i. **Assert:** *generatorBody* is an **Abstract Closure** with no parameters.
    - ii. Let *result* be **Completion**(*generatorBody*()).
  - e. **Assert:** If we return here, the async generator either threw an exception or performed either an implicit or explicit return.
  - f. Remove *acGenContext* from the **execution context stack** and restore the **execution context** that is at the top of the **execution context stack** as the **running execution context**.
  - g. Set *acGenerator*.[[AsyncGeneratorState]] to **completed**.
  - h. If *result*.[[Type]] is **normal**, set *result* to **NormalCompletion**(**undefined**).
  - i. If *result*.[[Type]] is **return**, set *result* to **NormalCompletion**(*result*.[[Value]]).
  - j. Perform **AsyncGeneratorCompleteStep**(*acGenerator*, *result*, **true**).
  - k. Perform **AsyncGeneratorDrainQueue**(*acGenerator*).
  - l. Return **undefined**.
5. Set the code evaluation state of *genContext* such that when evaluation is resumed for that **execution context**, *closure* will be called with no arguments.
6. Set *generator*.[[AsyncGeneratorContext]] to *genContext*.
7. Set *generator*.[[AsyncGeneratorState]] to **suspendedStart**.



8. Set *generator*.[[AsyncGeneratorQueue]] to a new empty List.
9. Return unused.

### 27.6.3.3 AsyncGeneratorValidate ( *generator*, *generatorBrand* )

The abstract operation AsyncGeneratorValidate takes arguments *generator* (an ECMAScript language value) and *generatorBrand* (a String or empty) and returns either a normal completion containing unused or a throw completion. It performs the following steps when called:

1. Perform ? RequireInternalSlot(*generator*, [[AsyncGeneratorContext]]).
2. Perform ? RequireInternalSlot(*generator*, [[AsyncGeneratorState]]).
3. Perform ? RequireInternalSlot(*generator*, [[AsyncGeneratorQueue]]).
4. If *generator*.[[GeneratorBrand]] is not *generatorBrand*, throw a **TypeError** exception.
5. Return unused.

### 27.6.3.4 AsyncGeneratorEnqueue ( *generator*, *completion*, *promiseCapability* )

The abstract operation AsyncGeneratorEnqueue takes arguments *generator* (an AsyncGenerator), *completion* (a Completion Record), and *promiseCapability* (a PromiseCapability Record) and returns unused. It performs the following steps when called:

1. Let *request* be AsyncGeneratorRequest { [[Completion]]: *completion*, [[Capability]]: *promiseCapability* }.
2. Append *request* to *generator*.[[AsyncGeneratorQueue]].
3. Return unused.

### 27.6.3.5 AsyncGeneratorCompleteStep ( *generator*, *completion*, *done* [ , *realm* ] )

The abstract operation AsyncGeneratorCompleteStep takes arguments *generator* (an AsyncGenerator), *completion* (a Completion Record), and *done* (a Boolean) and optional argument *realm* (a Realm Record) and returns unused. It performs the following steps when called:

1. Assert: *generator*.[[AsyncGeneratorQueue]] is not empty.
2. Let *next* be the first element of *generator*.[[AsyncGeneratorQueue]].
3. Remove the first element from *generator*.[[AsyncGeneratorQueue]].
4. Let *promiseCapability* be *next*.[[Capability]].
5. Let *value* be *completion*.[[Value]].
6. If *completion*.[[Type]] is throw, then
  - a. Perform ! Call(*promiseCapability*.[[Reject]], **undefined**, « *value* »).
7. Else,
  - a. Assert: *completion*.[[Type]] is normal.
  - b. If *realm* is present, then
    - i. Let *oldRealm* be the running execution context's Realm.
    - ii. Set the running execution context's Realm to *realm*.
    - iii. Let *iteratorResult* be CreateIterResultObject(*value*, *done*).
    - iv. Set the running execution context's Realm to *oldRealm*.
  - c. Else,
    - i. Let *iteratorResult* be CreateIterResultObject(*value*, *done*).
  - d. Perform ! Call(*promiseCapability*.[[Resolve]], **undefined**, « *iteratorResult* »).
8. Return unused.

### 27.6.3.6 AsyncGeneratorResume ( *generator*, *completion* )

The abstract operation AsyncGeneratorResume takes arguments *generator* (an AsyncGenerator) and *completion* (a Completion Record) and returns unused. It performs the following steps when called:

1. **Assert:** *generator*.[[AsyncGeneratorState]] is either suspendedStart or suspendedYield.
2. Let *genContext* be *generator*.[[AsyncGeneratorContext]].
3. Let *callerContext* be the running execution context.
4. Suspend *callerContext*.
5. Set *generator*.[[AsyncGeneratorState]] to executing.
6. Push *genContext* onto the execution context stack; *genContext* is now the running execution context.
7. Resume the suspended evaluation of *genContext* using *completion* as the result of the operation that suspended it. Let *result* be the Completion Record returned by the resumed computation.
8. **Assert:** *result* is never an abrupt completion.
9. **Assert:** When we return here, *genContext* has already been removed from the execution context stack and *callerContext* is the currently running execution context.
10. Return unused.

### 27.6.3.7 AsyncGeneratorUnwrapYieldResumption ( *resumptionValue* )

The abstract operation AsyncGeneratorUnwrapYieldResumption takes argument *resumptionValue* (a Completion Record) and returns either a normal completion containing an ECMAScript language value or an abrupt completion. It performs the following steps when called:

1. If *resumptionValue*.[[Type]] is not return, return ? *resumptionValue*.
2. Let *awaited* be Completion(Await(*resumptionValue*.[[Value]])).
3. If *awaited*.[[Type]] is throw, return ? *awaited*.
4. **Assert:** *awaited*.[[Type]] is normal.
5. Return Completion Record { [[Type]]: return, [[Value]]: *awaited*.[[Value]], [[Target]]: empty }.

### 27.6.3.8 AsyncGeneratorYield ( *value* )

The abstract operation AsyncGeneratorYield takes argument *value* (an ECMAScript language value) and returns either a normal completion containing an ECMAScript language value or an abrupt completion. It performs the following steps when called:

1. Let *genContext* be the running execution context.
2. **Assert:** *genContext* is the execution context of a generator.
3. Let *generator* be the value of the Generator component of *genContext*.
4. **Assert:** GetGeneratorKind() is async.
5. Let *completion* be NormalCompletion(*value*).
6. **Assert:** The execution context stack has at least two elements.
7. Let *previousContext* be the second to top element of the execution context stack.
8. Let *previousRealm* be *previousContext*'s Realm.
9. Perform AsyncGeneratorCompleteStep(*generator*, *completion*, false, *previousRealm*).
10. Let *queue* be *generator*.[[AsyncGeneratorQueue]].
11. If *queue* is not empty, then
  - a. NOTE: Execution continues without suspending the generator.
  - b. Let *toYield* be the first element of *queue*.
  - c. Let *resumptionValue* be Completion(*toYield*.[[Completion]]).
  - d. Return ? AsyncGeneratorUnwrapYieldResumption(*resumptionValue*).
12. Else,

- a. Set *generator*.[[AsyncGeneratorState]] to suspendedYield.
- b. Remove *genContext* from the *execution context stack* and restore the *execution context* that is at the top of the *execution context stack* as the *running execution context*.
- c. Let *callerContext* be the *running execution context*.
- d. Resume *callerContext* passing **undefined**. If *genContext* is ever resumed again, let *resumptionValue* be the *Completion Record* with which it is resumed.
- e. **Assert**: If control reaches here, then *genContext* is the *running execution context* again.
- f. Return ? *AsyncGeneratorUnwrapYieldResumption*(*resumptionValue*).

### 27.6.3.9 AsyncGeneratorAwaitReturn ( *generator* )

The abstract operation AsyncGeneratorAwaitReturn takes argument *generator* (an AsyncGenerator) and returns either a *normal completion containing unused* or a *throw completion*. It performs the following steps when called:

1. Let *queue* be *generator*.[[AsyncGeneratorQueue]].
2. **Assert**: *queue* is not empty.
3. Let *next* be the first element of *queue*.
4. Let *completion* be *Completion*(*next*.[[Completion]]).
5. **Assert**: *completion*.[[Type]] is return.
6. Let *promise* be ? *PromiseResolve*(%Promise%, *completion*.[[Value]]).
7. Let *fulfilledClosure* be a new *Abstract Closure* with parameters (*value*) that captures *generator* and performs the following steps when called:
  - a. Set *generator*.[[AsyncGeneratorState]] to completed.
  - b. Let *result* be *NormalCompletion*(*value*).
  - c. Perform *AsyncGeneratorCompleteStep*(*generator*, *result*, **true**).
  - d. Perform *AsyncGeneratorDrainQueue*(*generator*).
  - e. Return **undefined**.
8. Let *onFulfilled* be *CreateBuiltinFunction*(*fulfilledClosure*, 1, "", « »).
9. Let *rejectedClosure* be a new *Abstract Closure* with parameters (*reason*) that captures *generator* and performs the following steps when called:
  - a. Set *generator*.[[AsyncGeneratorState]] to completed.
  - b. Let *result* be *ThrowCompletion*(*reason*).
  - c. Perform *AsyncGeneratorCompleteStep*(*generator*, *result*, **true**).
  - d. Perform *AsyncGeneratorDrainQueue*(*generator*).
  - e. Return **undefined**.
10. Let *onRejected* be *CreateBuiltinFunction*(*rejectedClosure*, 1, "", « »).
11. Perform *PerformPromiseThen*(*promise*, *onFulfilled*, *onRejected*).
12. Return unused.

### 27.6.3.10 AsyncGeneratorDrainQueue ( *generator* )

The abstract operation AsyncGeneratorDrainQueue takes argument *generator* (an AsyncGenerator) and returns unused. It drains the generator's AsyncGeneratorQueue until it encounters an *AsyncGeneratorRequest* which holds a *return completion*. It performs the following steps when called:

1. **Assert**: *generator*.[[AsyncGeneratorState]] is completed.
2. Let *queue* be *generator*.[[AsyncGeneratorQueue]].
3. If *queue* is empty, return unused.
4. Let *done* be **false**.
5. Repeat, while *done* is **false**,
  - a. Let *next* be the first element of *queue*.

- b. Let *completion* be `Completion(next.[[Completion]])`.
  - c. If *completion*.`[[Type]]` is `return`, then
    - i. Set *generator*.`[[AsyncGeneratorState]]` to `awaiting-return`.
    - ii. Perform ! `AsyncGeneratorAwaitReturn(generator)`.
    - iii. Set *done* to `true`.
  - d. Else,
    - i. If *completion*.`[[Type]]` is `normal`, then
      1. Set *completion* to `NormalCompletion(undefined)`.
    - ii. Perform `AsyncGeneratorCompleteStep(generator, completion, true)`.
    - iii. If *queue* is empty, set *done* to `true`.
6. Return unused.

### 27.6.3.11 CreateAsyncIteratorFromClosure ( *closure*, *generatorBrand*, *generatorPrototype* )

The abstract operation `CreateAsyncIteratorFromClosure` takes arguments *closure* (an `Abstract Closure` with no parameters), *generatorBrand* (a String or empty), and *generatorPrototype* (an Object) and returns an `AsyncGenerator`. It performs the following steps when called:

1. NOTE: *closure* can contain uses of the `Await` operation and uses of the `Yield` operation to yield an `IteratorResult` object.
2. Let *internalSlotsList* be « `[[AsyncGeneratorState]]`, `[[AsyncGeneratorContext]]`, `[[AsyncGeneratorQueue]]`, `[[GeneratorBrand]]` ».
3. Let *generator* be `OrdinaryObjectCreate(generatorPrototype, internalSlotsList)`.
4. Set *generator*.`[[GeneratorBrand]]` to *generatorBrand*.
5. Set *generator*.`[[AsyncGeneratorState]]` to `undefined`.
6. Let *callerContext* be the `running execution context`.
7. Let *calleeContext* be a new `execution context`.
8. Set the Function of *calleeContext* to `null`.
9. Set the `Realm` of *calleeContext* to the `current Realm Record`.
10. Set the `ScriptOrModule` of *calleeContext* to *callerContext*'s `ScriptOrModule`.
11. If *callerContext* is not already suspended, suspend *callerContext*.
12. Push *calleeContext* onto the `execution context stack`; *calleeContext* is now the `running execution context`.
13. Perform `AsyncGeneratorStart(generator, closure)`.
14. Remove *calleeContext* from the `execution context stack` and restore *callerContext* as the `running execution context`.
15. Return *generator*.

## 27.7 AsyncFunction Objects

`AsyncFunctions` are functions that are usually created by evaluating `AsyncFunctionDeclarations`, `AsyncFunctionExpressions`, `AsyncMethods`, and `AsyncArrowFunctions`. They may also be created by calling the `%AsyncFunction%` intrinsic.

### 27.7.1 The AsyncFunction Constructor

The `AsyncFunction` constructor:

- is `%AsyncFunction%`.
- is a subclass of `Function`.

- creates and initializes a new AsyncFunction when called as a function rather than as a [constructor](#). Thus the function call `AsyncFunction(...)` is equivalent to the object creation expression `new AsyncFunction(...)` with the same arguments.
- may be used as the value of an **extends** clause of a class definition. Subclass [constructors](#) that intend to inherit the specified AsyncFunction behaviour must include a **super** call to the AsyncFunction [constructor](#) to create and initialize a subclass instance with the internal slots necessary for built-in async function behaviour. All ECMAScript syntactic forms for defining async [function objects](#) create direct instances of AsyncFunction. There is no syntactic means to create instances of AsyncFunction subclasses.

### 27.7.1.1 AsyncFunction ( ...*parameterArgs*, *bodyArg* )

The last argument (if any) specifies the body (executable code) of an async function. Any preceding arguments specify formal parameters.

This function performs the following steps when called:

1. Let *C* be the [active function object](#).
2. If *bodyArg* is not present, set *bodyArg* to the empty String.
3. Return ? [CreateDynamicFunction](#)(*C*, NewTarget, async, *parameterArgs*, *bodyArg*).

NOTE See NOTE for [20.2.1.1](#).

## 27.7.2 Properties of the AsyncFunction Constructor

The AsyncFunction [constructor](#):

- is a standard built-in [function object](#) that inherits from the Function [constructor](#).
- has a `[[Prototype]]` internal slot whose value is `%Function%`.
- has a **"name"** property whose value is **"AsyncFunction"**.
- has the following properties:

### 27.7.2.1 AsyncFunction.length

This is a [data property](#) with a value of 1. This property has the attributes { `[[Writable]]`: **false**, `[[Enumerable]]`: **false**, `[[Configurable]]`: **true** }.

### 27.7.2.2 AsyncFunction.prototype

The initial value of `AsyncFunction.prototype` is the [AsyncFunction prototype object](#).

This property has the attributes { `[[Writable]]`: **false**, `[[Enumerable]]`: **false**, `[[Configurable]]`: **false** }.

## 27.7.3 Properties of the AsyncFunction Prototype Object

The *AsyncFunction prototype object*:

- is `%AsyncFunction.prototype%`.
- is an [ordinary object](#).
- is not a [function object](#) and does not have an `[[ECMAScriptCode]]` internal slot or any other of the internal slots listed in [Table 30](#).
- has a `[[Prototype]]` internal slot whose value is `%Function.prototype%`.

### 27.7.3.1 AsyncFunction.prototype.constructor

The initial value of `AsyncFunction.prototype.constructor` is `%AsyncFunction%`.

This property has the attributes { `[[Writable]]`: **false**, `[[Enumerable]]`: **false**, `[[Configurable]]`: **true** }.

### 27.7.3.2 AsyncFunction.prototype [ @@toStringTag ]

The initial value of the `@@toStringTag` property is the String value **"AsyncFunction"**.

This property has the attributes { `[[Writable]]`: **false**, `[[Enumerable]]`: **false**, `[[Configurable]]`: **true** }.

## 27.7.4 AsyncFunction Instances

Every AsyncFunction instance is an ECMAScript [function object](#) and has the internal slots listed in [Table 30](#). The value of the `[[IsClassConstructor]]` internal slot for all such instances is **false**. AsyncFunction instances are not [constructors](#) and do not have a `[[Construct]]` internal method. AsyncFunction instances do not have a `prototype` property as they are not constructible.

Each AsyncFunction instance has the following own properties:

### 27.7.4.1 length

The specification for the **"length"** property of Function instances given in [20.2.4.1](#) also applies to AsyncFunction instances.

### 27.7.4.2 name

The specification for the **"name"** property of Function instances given in [20.2.4.2](#) also applies to AsyncFunction instances.

## 27.7.5 Async Functions Abstract Operations

### 27.7.5.1 AsyncFunctionStart ( *promiseCapability*, *asyncFunctionBody* )

The abstract operation AsyncFunctionStart takes arguments *promiseCapability* (a [PromiseCapability Record](#)) and *asyncFunctionBody* (a [FunctionBody Parse Node](#) or an [ExpressionBody Parse Node](#)) and returns unused. It performs the following steps when called:

1. Let *runningContext* be the [running execution context](#).
2. Let *asyncContext* be a copy of *runningContext*.
3. NOTE: Copying the execution state is required for [AsyncBlockStart](#) to resume its execution. It is ill-defined to resume a currently executing context.
4. Perform [AsyncBlockStart](#)(*promiseCapability*, *asyncFunctionBody*, *asyncContext*).
5. Return unused.

### 27.7.5.2 AsyncBlockStart ( *promiseCapability*, *asyncBody*, *asyncContext* )

The abstract operation AsyncBlockStart takes arguments *promiseCapability* (a [PromiseCapability Record](#)), *asyncBody* (a [Parse Node](#)), and *asyncContext* (an [execution context](#)) and returns unused. It performs the following steps when called:

1. **Assert:** *promiseCapability* is a **PromiseCapability Record**.
2. Let *runningContext* be the **running execution context**.
3. Let *closure* be a new **Abstract Closure** with no parameters that captures *promiseCapability* and *asyncBody* and performs the following steps when called:
  - a. Let *acAsyncContext* be the **running execution context**.
  - b. Let *result* be **Completion(Evaluation of *asyncBody*)**.
  - c. **Assert:** If we return here, the async function either threw an exception or performed an implicit or explicit return; all awaiting is done.
  - d. Remove *acAsyncContext* from the **execution context stack** and restore the **execution context** that is at the top of the **execution context stack** as the **running execution context**.
  - e. If *result*.[[Type]] is normal, then
    - i. Perform ! **Call**(*promiseCapability*.[[Resolve]], **undefined**, « **undefined** »).
  - f. Else if *result*.[[Type]] is return, then
    - i. Perform ! **Call**(*promiseCapability*.[[Resolve]], **undefined**, « *result*.[[Value]] »).
  - g. Else,
    - i. **Assert:** *result*.[[Type]] is throw.
    - ii. Perform ! **Call**(*promiseCapability*.[[Reject]], **undefined**, « *result*.[[Value]] »).
  - h. Return unused.
4. Set the code evaluation state of *asyncContext* such that when evaluation is resumed for that **execution context**, *closure* will be called with no arguments.
5. Push *asyncContext* onto the **execution context stack**; *asyncContext* is now the **running execution context**.
6. Resume the suspended evaluation of *asyncContext*. Let *result* be the value returned by the resumed computation.
7. **Assert:** When we return here, *asyncContext* has already been removed from the **execution context stack** and *runningContext* is the currently **running execution context**.
8. **Assert:** *result* is a **normal completion** with a value of unused. The possible sources of this value are **Await** or, if the async function doesn't await anything, step 3.h above.
9. Return unused.

### 27.7.5.3 Await ( *value* )

The abstract operation **Await** takes argument *value* (an **ECMAScript language value**) and returns either a **normal completion containing** either an **ECMAScript language value** or empty, or a **throw completion**. It performs the following steps when called:

1. Let *asyncContext* be the **running execution context**.
2. Let *promise* be ? **PromiseResolve**(%**Promise**%, *value*).
3. Let *fulfilledClosure* be a new **Abstract Closure** with parameters (*v*) that captures *asyncContext* and performs the following steps when called:
  - a. Let *prevContext* be the **running execution context**.
  - b. Suspend *prevContext*.
  - c. Push *asyncContext* onto the **execution context stack**; *asyncContext* is now the **running execution context**.
  - d. Resume the suspended evaluation of *asyncContext* using **NormalCompletion**(*v*) as the result of the operation that suspended it.
  - e. **Assert:** When we reach this step, *asyncContext* has already been removed from the **execution context stack** and *prevContext* is the currently **running execution context**.
  - f. Return **undefined**.
4. Let *onFulfilled* be **CreateBuiltinFunction**(*fulfilledClosure*, 1, "", « »).

5. Let *rejectedClosure* be a new **Abstract Closure** with parameters (*reason*) that captures *asyncContext* and performs the following steps when called:
  - a. Let *prevContext* be the **running execution context**.
  - b. Suspend *prevContext*.
  - c. Push *asyncContext* onto the **execution context stack**; *asyncContext* is now the **running execution context**.
  - d. Resume the suspended evaluation of *asyncContext* using **ThrowCompletion**(*reason*) as the result of the operation that suspended it.
  - e. **Assert**: When we reach this step, *asyncContext* has already been removed from the **execution context stack** and *prevContext* is the currently **running execution context**.
  - f. Return **undefined**.
6. Let *onRejected* be **CreateBuiltinFunction**(*rejectedClosure*, 1, "", « »).
7. Perform **PerformPromiseThen**(*promise*, *onFulfilled*, *onRejected*).
8. Remove *asyncContext* from the **execution context stack** and restore the **execution context** that is at the top of the **execution context stack** as the **running execution context**.
9. Let *callerContext* be the **running execution context**.
10. Resume *callerContext* passing empty. If *asyncContext* is ever resumed again, let *completion* be the **Completion Record** with which it is resumed.
11. **Assert**: If control reaches here, then *asyncContext* is the **running execution context** again.
12. Return *completion*.

## 28 Reflection

### 28.1 The Reflect Object

The Reflect object:

- is **%Reflect%**.
- is the initial value of the **"Reflect"** property of the **global object**.
- is an **ordinary object**.
- has a **[[Prototype]]** internal slot whose value is **%Object.prototype%**.
- is not a **function object**.
- does not have a **[[Construct]]** internal method; it cannot be used as a **constructor** with the **new** operator.
- does not have a **[[Call]]** internal method; it cannot be invoked as a function.

#### 28.1.1 Reflect.apply ( *target*, *thisArgument*, *argumentsList* )

This function performs the following steps when called:

1. If **IsCallable**(*target*) is **false**, throw a **TypeError** exception.
2. Let *args* be ? **CreateListFromArrayLike**(*argumentsList*).
3. Perform **PrepareForTailCall**().
4. Return ? **Call**(*target*, *thisArgument*, *args*).

#### 28.1.2 Reflect.construct ( *target*, *argumentsList* [ , *newTarget* ] )

This function performs the following steps when called:

1. If **IsConstructor**(*target*) is **false**, throw a **TypeError** exception.
2. If *newTarget* is not present, set *newTarget* to *target*.



3. Else if `IsConstructor(newTarget)` is **false**, throw a **TypeError** exception.
4. Let `args` be ? `CreateListFromArrayLike(argumentsList)`.
5. Return ? `Construct(target, args, newTarget)`.

### 28.1.3 Reflect.defineProperty ( *target*, *propertyKey*, *attributes* )

This function performs the following steps when called:

1. If *target* is not an Object, throw a **TypeError** exception.
2. Let *key* be ? `ToPropertyKey(propertyKey)`.
3. Let *desc* be ? `ToPropertyDescriptor(attributes)`.
4. Return ? `target.[[DefineOwnProperty]](key, desc)`.

### 28.1.4 Reflect.deleteProperty ( *target*, *propertyKey* )

This function performs the following steps when called:

1. If *target* is not an Object, throw a **TypeError** exception.
2. Let *key* be ? `ToPropertyKey(propertyKey)`.
3. Return ? `target.[[Delete]](key)`.

### 28.1.5 Reflect.get ( *target*, *propertyKey* [ , *receiver* ] )

This function performs the following steps when called:

1. If *target* is not an Object, throw a **TypeError** exception.
2. Let *key* be ? `ToPropertyKey(propertyKey)`.
3. If *receiver* is not present, then
  - a. Set *receiver* to *target*.
4. Return ? `target.[[Get]](key, receiver)`.

### 28.1.6 Reflect.getOwnPropertyDescriptor ( *target*, *propertyKey* )

This function performs the following steps when called:

1. If *target* is not an Object, throw a **TypeError** exception.
2. Let *key* be ? `ToPropertyKey(propertyKey)`.
3. Let *desc* be ? `target.[[GetOwnProperty]](key)`.
4. Return `FromPropertyDescriptor(desc)`.

### 28.1.7 Reflect.getPrototypeOf ( *target* )

This function performs the following steps when called:

1. If *target* is not an Object, throw a **TypeError** exception.
2. Return ? `target.[[GetPrototypeOf]]()`.

### 28.1.8 Reflect.has ( *target*, *propertyKey* )

This function performs the following steps when called:

1. If *target* is not an Object, throw a **TypeError** exception.
2. Let *key* be ? `ToPropertyKey(propertyKey)`.
3. Return ? `target.[[HasProperty]](key)`.

### 28.1.9 Reflect.isExtensible ( *target* )

This function performs the following steps when called:

1. If *target* is not an Object, throw a **TypeError** exception.
2. Return ? `target.[[IsExtensible]]()`.

### 28.1.10 Reflect.ownKeys ( *target* )

This function performs the following steps when called:

1. If *target* is not an Object, throw a **TypeError** exception.
2. Let *keys* be ? `target.[[OwnPropertyKeys]]()`.
3. Return `CreateArrayFromList(keys)`.

### 28.1.11 Reflect.preventExtensions ( *target* )

This function performs the following steps when called:

1. If *target* is not an Object, throw a **TypeError** exception.
2. Return ? `target.[[PreventExtensions]]()`.

### 28.1.12 Reflect.set ( *target*, *propertyKey*, *V* [ , *receiver* ] )

This function performs the following steps when called:

1. If *target* is not an Object, throw a **TypeError** exception.
2. Let *key* be ? `ToPropertyKey(propertyKey)`.
3. If *receiver* is not present, then
  - a. Set *receiver* to *target*.
4. Return ? `target.[[Set]](key, V, receiver)`.

### 28.1.13 Reflect.setPrototypeOf ( *target*, *proto* )

This function performs the following steps when called:

1. If *target* is not an Object, throw a **TypeError** exception.
2. If *proto* is not an Object and *proto* is not **null**, throw a **TypeError** exception.
3. Return ? `target.[[SetPrototypeOf]](proto)`.

### 28.1.14 Reflect [ @@toStringTag ]

The initial value of the `@@toStringTag` property is the String value **"Reflect"**.

This property has the attributes { `[[Writable]]: false`, `[[Enumerable]]: false`, `[[Configurable]]: true` }.

## 28.2 Proxy Objects

### 28.2.1 The Proxy Constructor

The Proxy [constructor](#):

- is `%Proxy%`.
- is the initial value of the **"Proxy"** property of the [global object](#).
- creates and initializes a new Proxy object when called as a [constructor](#).
- is not intended to be called as a function and will throw an exception when called in that manner.

#### 28.2.1.1 Proxy ( *target*, *handler* )

This function performs the following steps when called:

1. If `NewTarget` is **undefined**, throw a **TypeError** exception.
2. Return ? [ProxyCreate](#)(*target*, *handler*).

### 28.2.2 Properties of the Proxy Constructor

The Proxy [constructor](#):

- has a `[[Prototype]]` internal slot whose value is `%Function.prototype%`.
- does not have a **"prototype"** property because Proxy objects do not have a `[[Prototype]]` internal slot that requires initialization.
- has the following properties:

#### 28.2.2.1 Proxy.revocable ( *target*, *handler* )

This function creates a revocable Proxy object.

It performs the following steps when called:

1. Let *proxy* be ? [ProxyCreate](#)(*target*, *handler*).
2. Let *revokerClosure* be a new [Abstract Closure](#) with no parameters that captures nothing and performs the following steps when called:
  - a. Let *F* be the [active function object](#).
  - b. Let *p* be *F*.`[[RevocableProxy]]`.
  - c. If *p* is **null**, return **undefined**.
  - d. Set *F*.`[[RevocableProxy]]` to **null**.
  - e. **Assert**: *p* is a Proxy object.
  - f. Set *p*.`[[ProxyTarget]]` to **null**.
  - g. Set *p*.`[[ProxyHandler]]` to **null**.
  - h. Return **undefined**.
3. Let *revoker* be [CreateBuiltinFunction](#)(*revokerClosure*, 0, "", « `[[RevocableProxy]]` »).
4. Set *revoker*.`[[RevocableProxy]]` to *proxy*.
5. Let *result* be [OrdinaryObjectCreate](#)(`%Object.prototype%`).
6. Perform ! [CreateDataPropertyOrThrow](#)(*result*, **"proxy"**, *proxy*).
7. Perform ! [CreateDataPropertyOrThrow](#)(*result*, **"revoke"**, *revoker*).
8. Return *result*.

## 28.3 Module Namespace Objects

A Module Namespace Object is a [module namespace exotic object](#) that provides runtime property-based access to a module's exported bindings. There is no [constructor](#) function for Module Namespace Objects. Instead, such an object is created for each module that is imported by an *ImportDeclaration* that contains a *NameSpaceImport*.

In addition to the properties specified in [10.4.6](#) each Module Namespace Object has the following own property:

### 28.3.1 @@toStringTag

The initial value of the [@@toStringTag](#) property is the String value **"Module"**.

This property has the attributes { [\[\[Writable\]\]](#): **false**, [\[\[Enumerable\]\]](#): **false**, [\[\[Configurable\]\]](#): **false** }.

## 29 Memory Model

The memory consistency model, or *memory model*, specifies the possible orderings of [Shared Data Block events](#), arising via accessing TypedArray instances backed by a SharedArrayBuffer and via methods on the Atomics object. When the program has no data races (defined below), the ordering of events appears as sequentially consistent, i.e., as an interleaving of actions from each [agent](#). When the program has data races, shared memory operations may appear sequentially inconsistent. For example, programs may exhibit causality-violating behaviour and other astonishments. These astonishments arise from compiler transforms and the design of CPUs (e.g., out-of-order execution and speculation). The memory model defines both the precise conditions under which a program exhibits sequentially consistent behaviour as well as the possible values read from data races. To wit, there is no undefined behaviour.

The memory model is defined as relational constraints on events introduced by [abstract operations](#) on SharedArrayBuffer or by methods on the Atomics object during an evaluation.

**NOTE** This section provides an axiomatic model on events introduced by the [abstract operations](#) on SharedArrayBuffers. It bears stressing that the model is not expressible algorithmically, unlike the rest of this specification. The nondeterministic introduction of events by [abstract operations](#) is the interface between the operational semantics of ECMAScript evaluation and the axiomatic semantics of the memory model. The semantics of these events is defined by considering graphs of all events in an evaluation. These are neither Static Semantics nor Runtime Semantics. There is no demonstrated algorithmic implementation, but instead a set of constraints that determine if a particular event graph is allowed or disallowed.

### 29.1 Memory Model Fundamentals

Shared memory accesses (reads and writes) are divided into two groups, atomic accesses and data accesses, defined below. Atomic accesses are sequentially consistent, i.e., there is a strict total ordering of events agreed upon by all [agents](#) in an [agent cluster](#). Non-atomic accesses do not have a strict total ordering agreed upon by all [agents](#), i.e., unordered.

**NOTE 1** No orderings weaker than sequentially consistent and stronger than unordered, such as release-acquire, are supported.

A *Shared Data Block event* is either a *ReadSharedMemory*, *WriteSharedMemory*, or *ReadModifyWriteSharedMemory Record*.

Table 85: **ReadSharedMemory** Event Fields

Field Name	Value	Meaning
[[Order]]	SeqCst or Unordered	The weakest ordering guaranteed by the <a href="#">memory model</a> for the event.
[[NoTear]]	a Boolean	Whether this event is allowed to read from multiple write events with equal range as this event.
[[Block]]	a <a href="#">Shared Data Block</a>	The block the event operates on.
[[ByteIndex]]	a non-negative <a href="#">integer</a>	The byte address of the read in [[Block]].
[[ElementSize]]	a non-negative <a href="#">integer</a>	The size of the read.

Table 86: **WriteSharedMemory** Event Fields

Field Name	Value	Meaning
[[Order]]	SeqCst, Unordered, or Init	The weakest ordering guaranteed by the <a href="#">memory model</a> for the event.
[[NoTear]]	a Boolean	Whether this event is allowed to be read from multiple read events with equal range as this event.
[[Block]]	a <a href="#">Shared Data Block</a>	The block the event operates on.
[[ByteIndex]]	a non-negative <a href="#">integer</a>	The byte address of the write in [[Block]].
[[ElementSize]]	a non-negative <a href="#">integer</a>	The size of the write.
[[Payload]]	a <a href="#">List of byte values</a>	The <a href="#">List of byte values</a> to be read by other events.

Table 87: **ReadModifyWriteSharedMemory** Event Fields

Field Name	Value	Meaning
[[Order]]	SeqCst	Read-modify-write events are always sequentially consistent.
[[NoTear]]	<b>true</b>	Read-modify-write events cannot tear.
[[Block]]	a <a href="#">Shared Data Block</a>	The block the event operates on.
[[ByteIndex]]	a non-negative <a href="#">integer</a>	The byte address of the read-modify-write in [[Block]].
[[ElementSize]]	a non-negative <a href="#">integer</a>	The size of the read-modify-write.
[[Payload]]	a <a href="#">List of byte values</a>	The <a href="#">List of byte values</a> to be passed to [[ModifyOp]].
[[ModifyOp]]	a <a href="#">read-modify-write modification function</a>	An abstract closure that returns a modified <a href="#">List of byte values</a> from a read <a href="#">List of byte values</a> and [[Payload]].

These events are introduced by [abstract operations](#) or by methods on the `Atomics` object.

Some operations may also introduce *Synchronize* events. A *Synchronize event* has no fields, and exists purely to directly constrain the permitted orderings of other events.

In addition to [Shared Data Block](#) and Synchronize events, there are *host-specific* events.

Let the range of a ReadSharedMemory, WriteSharedMemory, or ReadModifyWriteSharedMemory event be the Set of contiguous *integers* from its `[[ByteIndex]]` to `[[ByteIndex]] + [[ElementSize]] - 1`. Two events' ranges are equal when the events have the same `[[Block]]`, and the ranges are element-wise equal. Two events' ranges are overlapping when the events have the same `[[Block]]`, the ranges are not equal and their intersection is non-empty. Two events' ranges are disjoint when the events do not have the same `[[Block]]` or their ranges are neither equal nor overlapping.

**NOTE 2** Examples of *host-specific* synchronizing events that should be accounted for are: sending a SharedArrayBuffer from one *agent* to another (e.g., by `postMessage` in a browser), starting and stopping *agents*, and communicating within the *agent cluster* via channels other than shared memory. It is assumed those events are appended to *agent-order* during evaluation like the other SharedArrayBuffer events.

Events are ordered within *candidate executions* by the relations defined below.

## 29.2 Agent Events Records

An *Agent Events Record* is a [Record](#) with the following fields.

**Table 88: Agent Events Record Fields**

Field Name	Value	Meaning
<code>[[AgentSignifier]]</code>	an <i>agent signifier</i>	The <i>agent</i> whose evaluation resulted in this ordering.
<code>[[EventList]]</code>	a <i>List</i> of events	Events are appended to the list during evaluation.
<code>[[AgentSynchronizesWith]]</code>	a <i>List</i> of pairs of <i>Synchronize events</i>	<i>Synchronize</i> relationships introduced by the operational semantics.

## 29.3 Chosen Value Records

A *Chosen Value Record* is a [Record](#) with the following fields.

**Table 89: Chosen Value Record Fields**

Field Name	Value	Meaning
<code>[[Event]]</code>	a <i>Shared Data Block event</i>	The <i>ReadSharedMemory</i> or <i>ReadModifyWriteSharedMemory</i> event that was introduced for this chosen value.
<code>[[ChosenValue]]</code>	a <i>List</i> of <i>byte values</i>	The bytes that were nondeterministically chosen during evaluation.

## 29.4 Candidate Executions

A *candidate execution* of the evaluation of an *agent cluster* is a [Record](#) with the following fields.

Table 90: Candidate Execution Record Fields

Field Name	Value	Meaning
[[EventsRecords]]	a List of Agent Events Records	Maps an agent to Lists of events appended during the evaluation.
[[ChosenValues]]	a List of Chosen Value Records	Maps ReadSharedMemory or ReadModifyWriteSharedMemory events to the List of byte values chosen during the evaluation.
[[AgentOrder]]	an agent-order Relation	Defined below.
[[ReadsBytesFrom]]	a reads-bytes-from mathematical function	Defined below.
[[ReadsFrom]]	a reads-from Relation	Defined below.
[[HostSynchronizesWith]]	a host-synchronizes-with Relation	Defined below.
[[SynchronizesWith]]	a synchronizes-with Relation	Defined below.
[[HappensBefore]]	a happens-before Relation	Defined below.

An *empty candidate execution* is a candidate execution Record whose fields are empty Lists and Relations.

## 29.5 Abstract Operations for the Memory Model

### 29.5.1 EventSet ( *execution* )

The abstract operation EventSet takes argument *execution* (a candidate execution) and returns a Set of events. It performs the following steps when called:

1. Let *events* be an empty Set.
2. For each Agent Events Record *aer* of *execution*.[[EventsRecords]], do
  - a. For each event *E* of *aer*.[[EventList]], do
    - i. Add *E* to *events*.
3. Return *events*.

### 29.5.2 SharedDataBlockEventSet ( *execution* )

The abstract operation SharedDataBlockEventSet takes argument *execution* (a candidate execution) and returns a Set of events. It performs the following steps when called:

1. Let *events* be an empty Set.
2. For each event *E* of EventSet(*execution*), do
  - a. If *E* is a ReadSharedMemory, WriteSharedMemory, or ReadModifyWriteSharedMemory event, add *E* to *events*.
3. Return *events*.

### 29.5.3 HostEventSet ( *execution* )

The abstract operation HostEventSet takes argument *execution* (a candidate execution) and returns a Set of events. It performs the following steps when called:

1. Let *events* be an empty Set.
2. For each event *E* of EventSet(*execution*), do
  - a. If *E* is not in SharedDataBlockEventSet(*execution*), add *E* to *events*.
3. Return *events*.

### 29.5.4 ComposeWriteEventBytes ( *execution*, *byteIndex*, *Ws* )

The abstract operation ComposeWriteEventBytes takes arguments *execution* (a candidate execution), *byteIndex* (a non-negative integer), and *Ws* (a List of either WriteSharedMemory or ReadModifyWriteSharedMemory events) and returns a List of byte values. It performs the following steps when called:

1. Let *byteLocation* be *byteIndex*.
2. Let *bytesRead* be a new empty List.
3. For each element *W* of *Ws*, do
  - a. Assert: *W* has *byteLocation* in its range.
  - b. Let *payloadIndex* be *byteLocation* - *W*.[[ByteIndex]].
  - c. If *W* is a WriteSharedMemory event, then
    - i. Let *byte* be *W*.[[Payload]][*payloadIndex*].
  - d. Else,
    - i. Assert: *W* is a ReadModifyWriteSharedMemory event.
    - ii. Let *bytes* be ValueOfReadEvent(*execution*, *W*).
    - iii. Let *bytesModified* be *W*.[[ModifyOp]](*bytes*, *W*.[[Payload]]).
    - iv. Let *byte* be *bytesModified*[*payloadIndex*].
  - e. Append *byte* to *bytesRead*.
  - f. Set *byteLocation* to *byteLocation* + 1.
4. Return *bytesRead*.

NOTE 1 The read-modify-write modification [[ModifyOp]] is given by the function properties on the Atomics object that introduce ReadModifyWriteSharedMemory events.

NOTE 2 This abstract operation composes a List of write events into a List of byte values. It is used in the event semantics of ReadSharedMemory and ReadModifyWriteSharedMemory events.

### 29.5.5 ValueOfReadEvent ( *execution*, *R* )

The abstract operation ValueOfReadEvent takes arguments *execution* (a candidate execution) and *R* (a ReadSharedMemory or ReadModifyWriteSharedMemory event) and returns a List of byte values. It performs the following steps when called:

1. Let *Ws* be *execution*.[[ReadsBytesFrom]](*R*).
2. Assert: *Ws* is a List of WriteSharedMemory or ReadModifyWriteSharedMemory events with length equal to *R*.[[ElementSize]].
3. Return ComposeWriteEventBytes(*execution*, *R*.[[ByteIndex]], *Ws*).



## 29.6 Relations of Candidate Executions

### 29.6.1 agent-order

For a candidate execution *execution*, *execution*.[[AgentOrder]] is a Relation on events that satisfies the following.

- For each pair (*E*, *D*) in *EventSet*(*execution*), *execution*.[[AgentOrder]] contains (*E*, *D*) if there is some Agent Events Record *aer* in *execution*.[[EventsRecords]] such that *E* and *D* are in *aer*.[[EventList]] and *E* is before *D* in List order of *aer*.[[EventList]].

NOTE Each agent introduces events in a per-agent strict total order during the evaluation. This is the union of those strict total orders.

### 29.6.2 reads-bytes-from

For a candidate execution *execution*, *execution*.[[ReadsBytesFrom]] is a mathematical function mapping events in *SharedDataBlockEventSet*(*execution*) to Lists of events in *SharedDataBlockEventSet*(*execution*) that satisfies the following conditions.

- For each *ReadSharedMemory* or *ReadModifyWriteSharedMemory* event *R* in *SharedDataBlockEventSet*(*execution*), *execution*.[[ReadsBytesFrom]](*R*) is a List of length *R*.[[ElementSize]] whose elements are *WriteSharedMemory* or *ReadModifyWriteSharedMemory* events *Ws* such that all of the following are true.
  - Each event *W* with index *i* in *Ws* has *R*.[[ByteIndex]] + *i* in its range.
  - *R* is not in *Ws*.

### 29.6.3 reads-from

For a candidate execution *execution*, *execution*.[[ReadsFrom]] is the least Relation on events that satisfies the following.

- For each pair (*R*, *W*) in *SharedDataBlockEventSet*(*execution*), *execution*.[[ReadsFrom]] contains (*R*, *W*) if *execution*.[[ReadsBytesFrom]](*R*) contains *W*.

### 29.6.4 host-synchronizes-with

For a candidate execution *execution*, *execution*.[[HostSynchronizesWith]] is a host-provided strict partial order on host-specific events that satisfies at least the following.

- If *execution*.[[HostSynchronizesWith]] contains (*E*, *D*), *E* and *D* are in *HostEventSet*(*execution*).
- There is no cycle in the union of *execution*.[[HostSynchronizesWith]] and *execution*.[[AgentOrder]].

NOTE 1 For two host-specific events *E* and *D*, *E* host-synchronizes-with *D* implies *E* happens-before *D*.

NOTE 2 The host-synchronizes-with relation allows the host to provide additional synchronization mechanisms, such as **postMessage** between HTML workers.

### 29.6.5 synchronizes-with

For a [candidate execution](#) *execution*, *execution*.[[SynchronizesWith]] is the least [Relation](#) on events that satisfies the following.

- For each pair (*R*, *W*) in *execution*.[[ReadsFrom]], *execution*.[[SynchronizesWith]] contains (*W*, *R*) if *R*.[[Order]] is SeqCst, *W*.[[Order]] is SeqCst, and *R* and *W* have equal ranges.
- For each element *eventsRecord* of *execution*.[[EventsRecords]], the following is true.
  - For each pair (*S*, *Sw*) in *eventsRecord*.[[AgentSynchronizesWith]], *execution*.[[SynchronizesWith]] contains (*S*, *Sw*).
- For each pair (*E*, *D*) in *execution*.[[HostSynchronizesWith]], *execution*.[[SynchronizesWith]] contains (*E*, *D*).

NOTE 1 Owing to convention, write events synchronizes-with read events, instead of read events synchronizes-with write events.

NOTE 2 Init events do not participate in synchronizes-with, and are instead constrained directly by [happens-before](#).

NOTE 3 Not all SeqCst events related by [reads-from](#) are related by synchronizes-with. Only events that also have equal ranges are related by synchronizes-with.

NOTE 4 For [Shared Data Block](#) events *R* and *W* such that *W* synchronizes-with *R*, *R* may [reads-from](#) other writes than *W*.

### 29.6.6 happens-before

For a [candidate execution](#) *execution*, *execution*.[[HappensBefore]] is the least [Relation](#) on events that satisfies the following.

- For each pair (*E*, *D*) in *execution*.[[AgentOrder]], *execution*.[[HappensBefore]] contains (*E*, *D*).
- For each pair (*E*, *D*) in *execution*.[[SynchronizesWith]], *execution*.[[HappensBefore]] contains (*E*, *D*).
- For each pair (*E*, *D*) in [SharedDataBlockEventSet](#)(*execution*), *execution*.[[HappensBefore]] contains (*E*, *D*) if *E*.[[Order]] is Init and *E* and *D* have overlapping ranges.
- For each pair (*E*, *D*) in [EventSet](#)(*execution*), *execution*.[[HappensBefore]] contains (*E*, *D*) if there is an event *F* such that the pairs (*E*, *F*) and (*F*, *D*) are in *execution*.[[HappensBefore]].

NOTE Because happens-before is a superset of [agent-order](#), [candidate executions](#) are consistent with the single-thread evaluation semantics of ECMAScript.

## 29.7 Properties of Valid Executions

### 29.7.1 Valid Chosen Reads

A [candidate execution](#) *execution* has valid chosen reads if the following algorithm returns **true**.

1. For each [ReadSharedMemory](#) or [ReadModifyWriteSharedMemory](#) event *R* of [SharedDataBlockEventSet](#)(*execution*), do

- a. Let *chosenValueRecord* be the element of *execution*.[[ChosenValues]] whose [[Event]] field is *R*.
  - b. Let *chosenValue* be *chosenValueRecord*.[[ChosenValue]].
  - c. Let *readValue* be *ValueOfReadEvent*(*execution*, *R*).
  - d. Let *chosenLen* be the number of elements in *chosenValue*.
  - e. Let *readLen* be the number of elements in *readValue*.
  - f. If *chosenLen* ≠ *readLen*, then
    - i. Return **false**.
  - g. If *chosenValue*[*i*] ≠ *readValue*[*i*] for some integer *i* in the interval from 0 (inclusive) to *chosenLen* (exclusive), then
    - i. Return **false**.
2. Return **true**.

### 29.7.2 Coherent Reads

A candidate execution *execution* has coherent reads if the following algorithm returns **true**.

1. For each *ReadSharedMemory* or *ReadModifyWriteSharedMemory* event *R* of *SharedDataBlockEventSet*(*execution*), do
  - a. Let *Ws* be *execution*.[[ReadsBytesFrom]](*R*).
  - b. Let *byteLocation* be *R*.[[ByteIndex]].
  - c. For each element *W* of *Ws*, do
    - i. If *execution*.[[HappensBefore]] contains (*R*, *W*), then
      1. Return **false**.
    - ii. If there exists a *WriteSharedMemory* or *ReadModifyWriteSharedMemory* event *V* that has *byteLocation* in its range such that the pairs (*W*, *V*) and (*V*, *R*) are in *execution*.[[HappensBefore]], then
      1. Return **false**.
    - iii. Set *byteLocation* to *byteLocation* + 1.
2. Return **true**.

### 29.7.3 Tear Free Reads

A candidate execution *execution* has tear free reads if the following algorithm returns **true**.

1. For each *ReadSharedMemory* or *ReadModifyWriteSharedMemory* event *R* of *SharedDataBlockEventSet*(*execution*), do
  - a. If *R*.[[NoTear]] is **true**, then
    - i. **Assert**: The remainder of dividing *R*.[[ByteIndex]] by *R*.[[ElementSize]] is 0.
    - ii. For each event *W* such that *execution*.[[ReadsFrom]] contains (*R*, *W*) and *W*.[[NoTear]] is **true**, do
      1. If *R* and *W* have equal ranges and there exists an event *V* such that *V* and *W* have equal ranges, *V*.[[NoTear]] is **true**, *W* is not *V*, and *execution*.[[ReadsFrom]] contains (*R*, *V*), then
        - a. Return **false**.
2. Return **true**.

NOTE An event's `[[NoTear]]` field is **true** when that event was introduced via accessing an `integer` TypedArray, and **false** when introduced via accessing a floating point TypedArray or DataView.

Intuitively, this requirement says when a memory range is accessed in an aligned fashion via an `integer` TypedArray, a single write event on that range must "win" when in a data race with other write events with equal ranges. More precisely, this requirement says an aligned read event cannot read a value composed of bytes from multiple, different write events all with equal ranges. It is possible, however, for an aligned read event to read from multiple write events with overlapping ranges.

### 29.7.4 Sequentially Consistent Atomics

For a `candidate execution` *execution*, memory-order is a `strict total order` of all events in `EventSet(execution)` that satisfies the following.

- For each pair  $(E, D)$  in *execution*.`[[HappensBefore]]`,  $(E, D)$  is in memory-order.
- For each pair  $(R, W)$  in *execution*.`[[ReadsFrom]]`, there is no `WriteSharedMemory` or `ReadModifyWriteSharedMemory` event  $V$  in `SharedDataBlockEventSet(execution)` such that  $V$ .`[[Order]]` is `SeqCst`, the pairs  $(W, V)$  and  $(V, R)$  are in memory-order, and any of the following conditions are true.
  - *execution*.`[[SynchronizesWith]]` contains the pair  $(W, R)$ , and  $V$  and  $R$  have equal ranges.
  - The pairs  $(W, R)$  and  $(V, R)$  are in *execution*.`[[HappensBefore]]`,  $W$ .`[[Order]]` is `SeqCst`, and  $W$  and  $V$  have equal ranges.
  - The pairs  $(W, R)$  and  $(W, V)$  are in *execution*.`[[HappensBefore]]`,  $R$ .`[[Order]]` is `SeqCst`, and  $V$  and  $R$  have equal ranges.

NOTE 1 This clause additionally constrains `SeqCst` events on equal ranges.

- For each `WriteSharedMemory` or `ReadModifyWriteSharedMemory` event  $W$  in `SharedDataBlockEventSet(execution)`, if  $W$ .`[[Order]]` is `SeqCst`, then it is not the case that there is an infinite number of `ReadSharedMemory` or `ReadModifyWriteSharedMemory` events in `SharedDataBlockEventSet(execution)` with equal range that is memory-order before  $W$ .

NOTE 2 This clause together with the forward progress guarantee on `agents` ensure the liveness condition that `SeqCst` writes become visible to `SeqCst` reads with equal range in `finite` time.

A `candidate execution` has sequentially consistent atomics if a memory-order exists.

NOTE 3 While memory-order includes all events in `EventSet(execution)`, those that are not constrained by `happens-before` or `synchronizes-with` are allowed to occur anywhere in the order.

### 29.7.5 Valid Executions

A `candidate execution` *execution* is a valid execution (or simply an execution) if all of the following are true.

- The `host` provides a `host-synchronizes-with Relation` for *execution*.`[[HostSynchronizesWith]]`.
- *execution*.`[[HappensBefore]]` is a `strict partial order`.
- *execution* has valid chosen reads.
- *execution* has coherent reads.
- *execution* has tear free reads.

- *execution* has sequentially consistent atomics.

All programs have at least one valid execution.

## 29.8 Races

For an execution *execution*, two events *E* and *D* in `SharedDataBlockEventSet(execution)` are in a race if the following algorithm returns **true**.

1. If *E* is not *D*, then
  - a. If the pairs (*E*, *D*) and (*D*, *E*) are not in *execution*.`[[HappensBefore]]`, then
    - i. If *E* and *D* are both `WriteSharedMemory` or `ReadModifyWriteSharedMemory` events and *E* and *D* do not have disjoint ranges, then
      1. Return **true**.
    - ii. If *execution*.`[[ReadsFrom]]` contains either (*E*, *D*) or (*D*, *E*), then
      1. Return **true**.
2. Return **false**.

## 29.9 Data Races

For an execution *execution*, two events *E* and *D* in `SharedDataBlockEventSet(execution)` are in a data race if the following algorithm returns **true**.

1. If *E* and *D* are in a race in *execution*, then
  - a. If *E*.`[[Order]]` is not `SeqCst` or *D*.`[[Order]]` is not `SeqCst`, then
    - i. Return **true**.
  - b. If *E* and *D* have overlapping ranges, then
    - i. Return **true**.
2. Return **false**.

## 29.10 Data Race Freedom

An execution *execution* is data race free if there are no two events in `SharedDataBlockEventSet(execution)` that are in a data race.

A program is data race free if all its executions are data race free.

The `memory model` guarantees sequential consistency of all events for data race free programs.

## 29.11 Shared Memory Guidelines

NOTE 1 The following are guidelines for ECMAScript programmers working with shared memory.

We recommend programs be kept data race free, i.e., make it so that it is impossible for there to be concurrent non-atomic operations on the same memory location. Data race free programs have interleaving semantics where each step in the evaluation semantics of each `agent` are interleaved with each other. For data race free programs, it is not necessary to understand the details of the `memory model`. The details are unlikely to build intuition that will help one to better write ECMAScript.

More generally, even if a program is not data race free it may have predictable behaviour, so long as atomic operations are not involved in any data races and the operations that race all have the same access size. The simplest way to arrange for atomics not to be involved in races is to ensure that different memory cells are used by atomic and non-atomic operations and that atomic accesses of different sizes are not used to access the same cells at the same time. Effectively, the program should treat shared memory as strongly typed as much as possible. One still cannot depend on the ordering and timing of non-atomic accesses that race, but if memory is treated as strongly typed the racing accesses will not "tear" (bits of their values will not be mixed).

NOTE 2 The following are guidelines for ECMAScript implementers writing compiler transformations for programs using shared memory.

It is desirable to allow most program transformations that are valid in a single-agent setting in a multi-agent setting, to ensure that the performance of each agent in a multi-agent program is as good as it would be in a single-agent setting. Frequently these transformations are hard to judge. We outline some rules about program transformations that are intended to be taken as normative (in that they are implied by the memory model or stronger than what the memory model implies) but which are likely not exhaustive. These rules are intended to apply to program transformations that precede the introductions of the events that make up the agent-order.

Let an *agent-order slice* be the subset of the agent-order pertaining to a single agent.

Let *possible read values* of a read event be the set of all values of `ValueOfReadEvent` for that event across all valid executions.

Any transformation of an agent-order slice that is valid in the absence of shared memory is valid in the presence of shared memory, with the following exceptions.

- *Atomics are carved in stone*: Program transformations must not cause the SeqCst events in an agent-order slice to be reordered with its Unordered operations, nor its SeqCst operations to be reordered with each other, nor may a program transformation remove a SeqCst operation from the agent-order.

(In practice, the prohibition on reorderings forces a compiler to assume that every SeqCst operation is a synchronization and included in the final memory-order, which it would usually have to assume anyway in the absence of inter-agent program analysis. It also forces the compiler to assume that every call where the callee's effects on the memory-order are unknown may contain SeqCst operations.)

- *Reads must be stable*: Any given shared memory read must only observe a single value in an execution.

(For example, if what is semantically a single read in the program is executed multiple times then the program is subsequently allowed to observe only one of the values read. A transformation known as rematerialization can violate this rule.)

- *Writes must be stable*: All observable writes to shared memory must follow from program semantics in an execution.

(For example, a transformation may not introduce certain observable writes, such as by using read-modify-write operations on a larger location to write a smaller datum, writing a value to memory that the program could not have written, or writing a just-read value back to the location it was read from, if that location could have been overwritten by another agent after the read.)

- *Possible read values must be non-empty*: Program transformations cannot cause the possible read values of a shared memory read to become empty.

(Counterintuitively, this rule in effect restricts transformations on writes, because writes have force in [memory model](#) insofar as to be read by read events. For example, writes may be moved and coalesced and sometimes reordered between two SeqCst operations, but the transformation may not remove every write that updates a location; some write must be preserved.)

Examples of transformations that remain valid are: merging multiple non-atomic reads from the same location, reordering non-atomic reads, introducing speculative non-atomic reads, merging multiple non-atomic writes to the same location, reordering non-atomic writes to different locations, and hoisting non-atomic reads out of loops even if that affects termination. Note in general that aliased TypedArrays make it hard to prove that locations are different.

NOTE 3 The following are guidelines for ECMAScript implementers generating machine code for shared memory accesses.

For architectures with memory models no weaker than those of ARM or Power, non-atomic stores and loads may be compiled to bare stores and loads on the target architecture. Atomic stores and loads may be compiled down to instructions that guarantee sequential consistency. If no such instructions exist, memory barriers are to be employed, such as placing barriers on both sides of a bare store or load. Read-modify-write operations may be compiled to read-modify-write instructions on the target architecture, such as **LOCK**-prefixed instructions on x86, load-exclusive/store-exclusive instructions on ARM, and load-link/store-conditional instructions on Power.

Specifically, the [memory model](#) is intended to allow code generation as follows.

- Every atomic operation in the program is assumed to be necessary.
- Atomic operations are never rearranged with each other or with non-atomic operations.
- Functions are always assumed to perform atomic operations.
- Atomic operations are never implemented as read-modify-write operations on larger data, but as non-lock-free atomics if the platform does not have atomic operations of the appropriate size. (We already assume that every platform has normal memory access operations of every interesting size.)

Naive code generation uses these patterns:

- Regular loads and stores compile to single load and store instructions.
- Lock-free atomic loads and stores compile to a full (sequentially consistent) fence, a regular load or store, and a full fence.
- Lock-free atomic read-modify-write accesses compile to a full fence, an atomic read-modify-write instruction sequence, and a full fence.
- Non-lock-free atomics compile to a spinlock acquire, a full fence, a series of non-atomic load and store instructions, a full fence, and a spinlock release.

That mapping is correct so long as an atomic operation on an address range does not race with a non-atomic write or with an atomic operation of different size. However, that is all we need: the [memory model](#) effectively demotes the atomic operations involved in a race to non-atomic status. On the other hand, the naive mapping is quite strong: it allows atomic operations to be used as sequentially consistent fences, which the [memory model](#) does not actually guarantee.

Local improvements to those basic patterns are also allowed, subject to the constraints of the [memory model](#). For example:

- There are obvious platform-dependent improvements that remove redundant fences. For example, on x86 the fences around lock-free atomic loads and stores can always be omitted except for the fence following a store, and no fence is needed for lock-free read-modify-write instructions, as these all use **LOCK**-prefixed instructions. On many platforms there are fences of several strengths, and weaker fences can be used in certain contexts without destroying sequential consistency.
- Most modern platforms support lock-free atomics for all the data sizes required by ECMAScript atomics. Should non-lock-free atomics be needed, the fences surrounding the body of the atomic operation can usually be folded into the lock and unlock steps. The simplest solution for non-lock-free atomics is to have a single lock word per SharedArrayBuffer.
- There are also more complicated platform-dependent local improvements, requiring some code analysis. For example, two back-to-back fences often have the same effect as a single fence, so if code is generated for two atomic operations in sequence, only a single fence need separate them. On x86, even a single fence separating atomic stores can be omitted, as the fence following a store is only needed to separate the store from a subsequent load.



## Annex A

(informative)

### Grammar Summary

#### A.1 Lexical Grammar

*SourceCharacter* ::  
    any Unicode code point

*InputElementDiv* ::  
    *WhiteSpace*  
    *LineTerminator*  
    *Comment*  
    *CommonToken*  
    *DivPunctuator*  
    *RightBracePunctuator*

*InputElementRegExp* ::  
    *WhiteSpace*  
    *LineTerminator*  
    *Comment*  
    *CommonToken*  
    *RightBracePunctuator*  
    *RegularExpressionLiteral*

*InputElementRegExpOrTemplateTail* ::  
    *WhiteSpace*  
    *LineTerminator*  
    *Comment*  
    *CommonToken*  
    *RegularExpressionLiteral*  
    *TemplateSubstitutionTail*

*InputElementTemplateTail* ::  
    *WhiteSpace*  
    *LineTerminator*  
    *Comment*  
    *CommonToken*  
    *DivPunctuator*  
    *TemplateSubstitutionTail*

*InputElementHashbangOrRegExp* ::  
    *WhiteSpace*  
    *LineTerminator*  
    *Comment*  
    *CommonToken*  
    *HashbangComment*  
    *RegularExpressionLiteral*

*WhiteSpace* ::  
    <TAB>  
    <VT>

```

    <FF>
    <ZWNBSP>
    <USP>
LineTerminator ::
    <LF>
    <CR>
    <LS>
    <PS>
LineTerminatorSequence ::
    <LF>
    <CR> [lookahead ≠ <LF>]
    <LS>
    <PS>
    <CR> <LF>
Comment ::
    MultiLineComment
    SingleLineComment
MultiLineComment ::
    /* MultiLineCommentCharsopt */
MultiLineCommentChars ::
    MultiLineNotAsteriskChar MultiLineCommentCharsopt
    * PostAsteriskCommentCharsopt
PostAsteriskCommentChars ::
    MultiLineNotForwardSlashOrAsteriskChar MultiLineCommentCharsopt
    * PostAsteriskCommentCharsopt
MultiLineNotAsteriskChar ::
    SourceCharacter but not *
MultiLineNotForwardSlashOrAsteriskChar ::
    SourceCharacter but not one of / or *
SingleLineComment ::
    // SingleLineCommentCharsopt
SingleLineCommentChars ::
    SingleLineCommentChar SingleLineCommentCharsopt
SingleLineCommentChar ::
    SourceCharacter but not LineTerminator
HashbangComment ::
    #! SingleLineCommentCharsopt
CommonToken ::
    IdentifierName
    PrivateIdentifier
    Punctuator
    NumericLiteral
    StringLiteral
    Template
PrivateIdentifier ::
    # IdentifierName
IdentifierName ::
    IdentifierStart
    IdentifierName IdentifierPart
IdentifierStart ::
    IdentifierStartChar
    \ UnicodeEscapeSequence
IdentifierPart ::
    IdentifierPartChar
    \ UnicodeEscapeSequence

```

```

IdentifierStartChar ::
    UnicodeIDStart
    $

IdentifierPartChar ::
    UnicodeIDContinue
    $
    <ZWJ>
    <ZWJ>

AsciiLetter :: one of
    a b c d e f g h i j k l m n o p q r s t u v w x y z A B C D E F G H I J K L M N
    O P Q R S T U V W X Y Z

UnicodeIDStart ::
    any Unicode code point with the Unicode property "ID_Start"

UnicodeIDContinue ::
    any Unicode code point with the Unicode property "ID_Continue"

ReservedWord :: one of
    await break case catch class const continue debugger default delete do else
    enum export extends false finally for function if import in instanceof
    new null return super switch this throw true try typeof var void while
    with yield

Punctuator ::
    OptionalChainingPunctuator
    OtherPunctuator

OptionalChainingPunctuator ::
    ?. [lookahead ∉ DecimalDigit]

OtherPunctuator :: one of
    { ( ) [ ] . . . ; , < > <= >= == != === !== + - * % ** ++ -- << >> >>> & | ^ !
    ~ && || ?? ? : = += -= *= %= **= <<= >>= >>>= &= |= ^= &&= || = ??= =>

DivPunctuator ::
    /
    /=

RightBracePunctuator ::
    }

NullLiteral ::
    null

BooleanLiteral ::
    true
    false

NumericLiteralSeparator ::

NumericLiteral ::
    DecimalLiteral
    DecimalBigIntegerLiteral
    NonDecimalIntegerLiteral [+Sep]
    NonDecimalIntegerLiteral [+Sep] BigIntLiteralSuffix
    LegacyOctalIntegerLiteral

DecimalBigIntegerLiteral ::
    0 BigIntLiteralSuffix
    NonZeroDigit DecimalDigits [+Sep] opt BigIntLiteralSuffix
    NonZeroDigit NumericLiteralSeparator DecimalDigits [+Sep] BigIntLiteralSuffix

NonDecimalIntegerLiteral [+Sep] ::
    BinaryIntegerLiteral [+Sep]
    OctalIntegerLiteral [+Sep]
    HexIntegerLiteral [+Sep]

```

*BigIntLiteralSuffix* ::  
**n**

*DecimalLiteral* ::  
*DecimalIntegerLiteral* . *DecimalDigits*<sub>[+Sep] opt</sub> *ExponentPart*<sub>[+Sep] opt</sub>  
. *DecimalDigits*<sub>[+Sep]</sub> *ExponentPart*<sub>[+Sep] opt</sub>  
*DecimalIntegerLiteral* *ExponentPart*<sub>[+Sep] opt</sub>

*DecimalIntegerLiteral* ::  
**0**  
*NonZeroDigit*  
*NonZeroDigit* *NumericLiteralSeparator*<sub>opt</sub> *DecimalDigits*<sub>[+Sep]</sub>  
*NonOctalDecimalIntegerLiteral*

*DecimalDigits*<sub>[Sep]</sub> ::  
*DecimalDigit*  
*DecimalDigits*<sub>[?Sep]</sub> *DecimalDigit*  
<sub>[+Sep]</sub> *DecimalDigits*<sub>[+Sep]</sub> *NumericLiteralSeparator* *DecimalDigit*

*DecimalDigit* :: **one of**  
**0 1 2 3 4 5 6 7 8 9**

*NonZeroDigit* :: **one of**  
**1 2 3 4 5 6 7 8 9**

*ExponentPart*<sub>[Sep]</sub> ::  
*ExponentIndicator* *SignedInteger*<sub>[?Sep]</sub>

*ExponentIndicator* :: **one of**  
**e E**

*SignedInteger*<sub>[Sep]</sub> ::  
*DecimalDigits*<sub>[?Sep]</sub>  
+ *DecimalDigits*<sub>[?Sep]</sub>  
- *DecimalDigits*<sub>[?Sep]</sub>

*BinaryIntegerLiteral*<sub>[Sep]</sub> ::  
**0b** *BinaryDigits*<sub>[?Sep]</sub>  
**0B** *BinaryDigits*<sub>[?Sep]</sub>

*BinaryDigits*<sub>[Sep]</sub> ::  
*BinaryDigit*  
*BinaryDigits*<sub>[?Sep]</sub> *BinaryDigit*  
<sub>[+Sep]</sub> *BinaryDigits*<sub>[+Sep]</sub> *NumericLiteralSeparator* *BinaryDigit*

*BinaryDigit* :: **one of**  
**0 1**

*OctalIntegerLiteral*<sub>[Sep]</sub> ::  
**0o** *OctalDigits*<sub>[?Sep]</sub>  
**0O** *OctalDigits*<sub>[?Sep]</sub>

*OctalDigits*<sub>[Sep]</sub> ::  
*OctalDigit*  
*OctalDigits*<sub>[?Sep]</sub> *OctalDigit*  
<sub>[+Sep]</sub> *OctalDigits*<sub>[+Sep]</sub> *NumericLiteralSeparator* *OctalDigit*

*LegacyOctalIntegerLiteral* ::  
**0** *OctalDigit*  
*LegacyOctalIntegerLiteral* *OctalDigit*

*NonOctalDecimalIntegerLiteral* ::  
**0** *NonOctalDigit*  
*LegacyOctalLikeDecimalIntegerLiteral* *NonOctalDigit*  
*NonOctalDecimalIntegerLiteral* *DecimalDigit*

*LegacyOctalLikeDecimalIntegerLiteral* ::  
     **0** *OctalDigit*  
     *LegacyOctalLikeDecimalIntegerLiteral* *OctalDigit*  
*OctalDigit* :: **one of**  
     **0 1 2 3 4 5 6 7**  
*NonOctalDigit* :: **one of**  
     **8 9**  
*HexIntegerLiteral*<sub>[Sep]</sub> ::  
     **0x** *HexDigits*<sub>[?Sep]</sub>  
     **0X** *HexDigits*<sub>[?Sep]</sub>  
*HexDigits*<sub>[Sep]</sub> ::  
     *HexDigit*  
     *HexDigits*<sub>[?Sep]</sub> *HexDigit*  
     [+Sep] *HexDigits*<sub>[+Sep]</sub> *NumericLiteralSeparator* *HexDigit*  
*HexDigit* :: **one of**  
     **0 1 2 3 4 5 6 7 8 9 a b c d e f A B C D E F**  
*StringLiteral* ::  
     " *DoubleStringCharacters*<sub>opt</sub> "  
     ' *SingleStringCharacters*<sub>opt</sub> '  
*DoubleStringCharacters* ::  
     *DoubleStringCharacter* *DoubleStringCharacters*<sub>opt</sub>  
*SingleStringCharacters* ::  
     *SingleStringCharacter* *SingleStringCharacters*<sub>opt</sub>  
*DoubleStringCharacter* ::  
     *SourceCharacter* but not one of " or \ or *LineTerminator*  
     <LS>  
     <PS>  
     \ *EscapeSequence*  
     *LineContinuation*  
*SingleStringCharacter* ::  
     *SourceCharacter* but not one of ' or \ or *LineTerminator*  
     <LS>  
     <PS>  
     \ *EscapeSequence*  
     *LineContinuation*  
*LineContinuation* ::  
     \ *LineTerminatorSequence*  
*EscapeSequence* ::  
     *CharacterEscapeSequence*  
     **0** [lookahead ≠ *DecimalDigit*]  
     *LegacyOctalEscapeSequence*  
     *NonOctalDecimalEscapeSequence*  
     *HexEscapeSequence*  
     *UnicodeEscapeSequence*  
*CharacterEscapeSequence* ::  
     *SingleEscapeCharacter*  
     *NonEscapeCharacter*  
*SingleEscapeCharacter* :: **one of**  
     ' " \ **b f n r t v**  
*NonEscapeCharacter* ::  
     *SourceCharacter* but not one of *EscapeCharacter* or *LineTerminator*  
*EscapeCharacter* ::  
     *SingleEscapeCharacter*  
     *DecimalDigit*  
     **x**

**u**

*LegacyOctalEscapeSequence* ::  
**0** [lookahead ∈ { **8** , **9** }]  
*NonZeroOctalDigit* [lookahead ∉ *OctalDigit*]  
*ZeroToThree OctalDigit* [lookahead ∉ *OctalDigit*]  
*FourToSeven OctalDigit*  
*ZeroToThree OctalDigit OctalDigit*

*NonZeroOctalDigit* ::  
*OctalDigit* but not **0**

*ZeroToThree* :: **one of**  
**0 1 2 3**

*FourToSeven* :: **one of**  
**4 5 6 7**

*NonOctalDecimalEscapeSequence* :: **one of**  
**8 9**

*HexEscapeSequence* ::  
**x** *HexDigit HexDigit*

*UnicodeEscapeSequence* ::  
**u** *Hex4Digits*  
**u**{ *CodePoint* }

*Hex4Digits* ::  
*HexDigit HexDigit HexDigit HexDigit*

*RegularExpressionLiteral* ::  
/ *RegularExpressionBody* / *RegularExpressionFlags*

*RegularExpressionBody* ::  
*RegularExpressionFirstChar RegularExpressionChars*

*RegularExpressionChars* ::  
[empty]  
*RegularExpressionChars RegularExpressionChar*

*RegularExpressionFirstChar* ::  
*RegularExpressionNonTerminator* but not one of \* or \ or / or [  
*RegularExpressionBackslashSequence*  
*RegularExpressionClass*

*RegularExpressionChar* ::  
*RegularExpressionNonTerminator* but not one of \ or / or [  
*RegularExpressionBackslashSequence*  
*RegularExpressionClass*

*RegularExpressionBackslashSequence* ::  
\  
*RegularExpressionNonTerminator*

*RegularExpressionNonTerminator* ::  
*SourceCharacter* but not *LineTerminator*

*RegularExpressionClass* ::  
[ *RegularExpressionClassChars* ]

*RegularExpressionClassChars* ::  
[empty]  
*RegularExpressionClassChars RegularExpressionClassChar*

*RegularExpressionClassChar* ::  
*RegularExpressionNonTerminator* but not one of ] or \  
*RegularExpressionBackslashSequence*

*RegularExpressionFlags* ::  
[empty]  
*RegularExpressionFlags IdentifierPartChar*

*Template* ::  
*NoSubstitutionTemplate*  
*TemplateHead*

*NoSubstitutionTemplate* ::  
`~` *TemplateCharacters*<sub>opt</sub> `~`

```

TemplateHead ::
  ~ TemplateCharactersopt ${
TemplateSubstitutionTail ::
  TemplateMiddle
  TemplateTail
TemplateMiddle ::
  } TemplateCharactersopt ${
TemplateTail ::
  } TemplateCharactersopt ~
TemplateCharacters ::
  TemplateCharacter TemplateCharactersopt
TemplateCharacter ::
  $ [lookahead ≠ {]
  \ TemplateEscapeSequence
  \ NotEscapeSequence
  LineContinuation
  LineTerminatorSequence
  SourceCharacter but not one of ~ or \ or $ or LineTerminator
TemplateEscapeSequence ::
  CharacterEscapeSequence
  0 [lookahead ≠ DecimalDigit]
  HexEscapeSequence
  UnicodeEscapeSequence
NotEscapeSequence ::
  0 DecimalDigit
  DecimalDigit but not 0
  x [lookahead ≠ HexDigit]
  x HexDigit [lookahead ≠ HexDigit]
  u [lookahead ≠ HexDigit] [lookahead ≠ {]
  u HexDigit [lookahead ≠ HexDigit]
  u HexDigit HexDigit [lookahead ≠ HexDigit]
  u HexDigit HexDigit HexDigit [lookahead ≠ HexDigit]
  u { [lookahead ≠ HexDigit]
  u { NotCodePoint [lookahead ≠ HexDigit]
  u { CodePoint [lookahead ≠ HexDigit] [lookahead ≠ }]}
NotCodePoint ::
  HexDigits [~Sep] but only if MV of HexDigits > 0x10FFFF
CodePoint ::
  HexDigits [~Sep] but only if MV of HexDigits ≤ 0x10FFFF

```

## A.2 Expressions

```

IdentifierReference [Yield, Await] :
  Identifier
  [~Yield] yield
  [~Await] await
BindingIdentifier [Yield, Await] :
  Identifier
  yield
  await
LabelIdentifier [Yield, Await] :
  Identifier
  [~Yield] yield

```

[~Await] **await**

Identifier :

IdentifierName but not ReservedWord

PrimaryExpression<sub>[Yield, Await]</sub> :

**this**

IdentifierReference<sub>[?Yield, ?Await]</sub>

Literal

ArrayLiteral<sub>[?Yield, ?Await]</sub>

ObjectLiteral<sub>[?Yield, ?Await]</sub>

FunctionExpression

ClassExpression<sub>[?Yield, ?Await]</sub>

GeneratorExpression

AsyncFunctionExpression

AsyncGeneratorExpression

RegularExpressionLiteral

TemplateLiteral<sub>[?Yield, ?Await, ~Tagged]</sub>

CoverParenthesizedExpressionAndArrowParameterList<sub>[?Yield, ?Await]</sub>

CoverParenthesizedExpressionAndArrowParameterList<sub>[Yield, Await]</sub> :

( Expression<sub>[+In, ?Yield, ?Await]</sub> )

( Expression<sub>[+In, ?Yield, ?Await]</sub> , )

( )

( ... BindingIdentifier<sub>[?Yield, ?Await]</sub> )

( ... BindingPattern<sub>[?Yield, ?Await]</sub> )

( Expression<sub>[+In, ?Yield, ?Await]</sub> , ... BindingIdentifier<sub>[?Yield, ?Await]</sub> )

( Expression<sub>[+In, ?Yield, ?Await]</sub> , ... BindingPattern<sub>[?Yield, ?Await]</sub> )

When processing an instance of the production

PrimaryExpression<sub>[Yield, Await]</sub> :

CoverParenthesizedExpressionAndArrowParameterList<sub>[?Yield, ?Await]</sub>

the interpretation of *CoverParenthesizedExpressionAndArrowParameterList* is refined using the following grammar:

ParenthesizedExpression<sub>[Yield, Await]</sub> :

( Expression<sub>[+In, ?Yield, ?Await]</sub> )

Literal :

NullLiteral

BooleanLiteral

NumericLiteral

StringLiteral

ArrayLiteral<sub>[Yield, Await]</sub> :

[ Elision<sub>opt</sub> ]

[ ElementList<sub>[?Yield, ?Await]</sub> ]

[ ElementList<sub>[?Yield, ?Await]</sub> , Elision<sub>opt</sub> ]

ElementList<sub>[Yield, Await]</sub> :

Elision<sub>opt</sub> AssignmentExpression<sub>[+In, ?Yield, ?Await]</sub>

Elision<sub>opt</sub> SpreadElement<sub>[?Yield, ?Await]</sub>

ElementList<sub>[?Yield, ?Await]</sub> , Elision<sub>opt</sub> AssignmentExpression<sub>[+In, ?Yield, ?Await]</sub>

ElementList<sub>[?Yield, ?Await]</sub> , Elision<sub>opt</sub> SpreadElement<sub>[?Yield, ?Await]</sub>



Elision :

```

    ,
    Elision ,
SpreadElement[Yield, Await] :
    ... AssignmentExpression[+In, ?Yield, ?Await]
ObjectLiteral[Yield, Await] :
    { }
    { PropertyDefinitionList[?Yield, ?Await] }
    { PropertyDefinitionList[?Yield, ?Await] , }
PropertyDefinitionList[Yield, Await] :
    PropertyDefinition[?Yield, ?Await]
    PropertyDefinitionList[?Yield, ?Await] , PropertyDefinition[?Yield, ?Await]
PropertyDefinition[Yield, Await] :
    IdentifierReference[?Yield, ?Await]
    CoverInitializedName[?Yield, ?Await]
    PropertyName[?Yield, ?Await] : AssignmentExpression[+In, ?Yield, ?Await]
    MethodDefinition[?Yield, ?Await]
    ... AssignmentExpression[+In, ?Yield, ?Await]
PropertyName[Yield, Await] :
    LiteralPropertyName
    ComputedPropertyName[?Yield, ?Await]
LiteralPropertyName :
    IdentifierName
    StringLiteral
    NumericLiteral
ComputedPropertyName[Yield, Await] :
    [ AssignmentExpression[+In, ?Yield, ?Await] ]
CoverInitializedName[Yield, Await] :
    IdentifierReference[?Yield, ?Await] Initializer[+In, ?Yield, ?Await]
Initializer[In, Yield, Await] :
    = AssignmentExpression[?In, ?Yield, ?Await]
TemplateLiteral[Yield, Await, Tagged] :
    NoSubstitutionTemplate
    SubstitutionTemplate[?Yield, ?Await, ?Tagged]
SubstitutionTemplate[Yield, Await, Tagged] :
    TemplateHead Expression[+In, ?Yield, ?Await] TemplateSpans[?Yield, ?Await, ?Tagged]
TemplateSpans[Yield, Await, Tagged] :
    TemplateTail
    TemplateMiddleList[?Yield, ?Await, ?Tagged] TemplateTail
TemplateMiddleList[Yield, Await, Tagged] :
    TemplateMiddle Expression[+In, ?Yield, ?Await]
    TemplateMiddleList[?Yield, ?Await, ?Tagged] TemplateMiddle
    Expression[+In, ?Yield, ?Await]
MemberExpression[Yield, Await] :
    PrimaryExpression[?Yield, ?Await]
    MemberExpression[?Yield, ?Await] [ Expression[+In, ?Yield, ?Await] ]
    MemberExpression[?Yield, ?Await] . IdentifierName

```

```

MemberExpression[?Yield, ?Await] TemplateLiteral[?Yield, ?Await, +Tagged]
SuperProperty[?Yield, ?Await]
MetaProperty
new MemberExpression[?Yield, ?Await] Arguments[?Yield, ?Await]
MemberExpression[?Yield, ?Await] . PrivateIdentifier
SuperProperty[Yield, Await] :
  super [ Expression[+In, ?Yield, ?Await] ]
  super . IdentifierName
MetaProperty :
  NewTarget
  ImportMeta
NewTarget :
  new . target
ImportMeta :
  import . meta
NewExpression[Yield, Await] :
  MemberExpression[?Yield, ?Await]
  new NewExpression[?Yield, ?Await]
CallExpression[Yield, Await] :
  CoverCallExpressionAndAsyncArrowHead[?Yield, ?Await]
  SuperCall[?Yield, ?Await]
  ImportCall[?Yield, ?Await]
  CallExpression[?Yield, ?Await] Arguments[?Yield, ?Await]
  CallExpression[?Yield, ?Await] [ Expression[+In, ?Yield, ?Await] ]
  CallExpression[?Yield, ?Await] . IdentifierName
  CallExpression[?Yield, ?Await] TemplateLiteral[?Yield, ?Await, +Tagged]
  CallExpression[?Yield, ?Await] . PrivateIdentifier

```

When processing an instance of the production

`CallExpression[Yield, Await] : CoverCallExpressionAndAsyncArrowHead[?Yield, ?Await]`  
the interpretation of `CoverCallExpressionAndAsyncArrowHead` is refined using the following grammar:

```

CallMemberExpression[Yield, Await] :
  MemberExpression[?Yield, ?Await] Arguments[?Yield, ?Await]
SuperCall[Yield, Await] :
  super Arguments[?Yield, ?Await]
ImportCall[Yield, Await] :
  import ( AssignmentExpression[+In, ?Yield, ?Await] )
Arguments[Yield, Await] :
  ( )
  ( ArgumentList[?Yield, ?Await] )
  ( ArgumentList[?Yield, ?Await] , )
ArgumentList[Yield, Await] :
  AssignmentExpression[+In, ?Yield, ?Await]
  ... AssignmentExpression[+In, ?Yield, ?Await]
  ArgumentList[?Yield, ?Await] , AssignmentExpression[+In, ?Yield, ?Await]
  ArgumentList[?Yield, ?Await] , ... AssignmentExpression[+In, ?Yield, ?Await]

```

*OptionalExpression*<sub>[Yield, Await]</sub> :  
*MemberExpression*<sub>[?Yield, ?Await]</sub> *OptionalChain*<sub>[?Yield, ?Await]</sub>  
*CallExpression*<sub>[?Yield, ?Await]</sub> *OptionalChain*<sub>[?Yield, ?Await]</sub>  
*OptionalExpression*<sub>[?Yield, ?Await]</sub> *OptionalChain*<sub>[?Yield, ?Await]</sub>

*OptionalChain*<sub>[Yield, Await]</sub> :  
 ?. *Arguments*<sub>[?Yield, ?Await]</sub>  
 ?. [ *Expression*<sub>[+In, ?Yield, ?Await]</sub> ]  
 ?. *IdentifierName*  
 ?. *TemplateLiteral*<sub>[?Yield, ?Await, +Tagged]</sub>  
 ?. *PrivateIdentifier*  
*OptionalChain*<sub>[?Yield, ?Await]</sub> *Arguments*<sub>[?Yield, ?Await]</sub>  
*OptionalChain*<sub>[?Yield, ?Await]</sub> [ *Expression*<sub>[+In, ?Yield, ?Await]</sub> ]  
*OptionalChain*<sub>[?Yield, ?Await]</sub> . *IdentifierName*  
*OptionalChain*<sub>[?Yield, ?Await]</sub> *TemplateLiteral*<sub>[?Yield, ?Await, +Tagged]</sub>  
*OptionalChain*<sub>[?Yield, ?Await]</sub> . *PrivateIdentifier*

*LeftHandSideExpression*<sub>[Yield, Await]</sub> :  
*NewExpression*<sub>[?Yield, ?Await]</sub>  
*CallExpression*<sub>[?Yield, ?Await]</sub>  
*OptionalExpression*<sub>[?Yield, ?Await]</sub>

*UpdateExpression*<sub>[Yield, Await]</sub> :  
*LeftHandSideExpression*<sub>[?Yield, ?Await]</sub>  
*LeftHandSideExpression*<sub>[?Yield, ?Await]</sub> [no *Line Terminator* here] ++  
*LeftHandSideExpression*<sub>[?Yield, ?Await]</sub> [no *Line Terminator* here] --  
 ++ *UnaryExpression*<sub>[?Yield, ?Await]</sub>  
 -- *UnaryExpression*<sub>[?Yield, ?Await]</sub>

*UnaryExpression*<sub>[Yield, Await]</sub> :  
*UpdateExpression*<sub>[?Yield, ?Await]</sub>  
**delete** *UnaryExpression*<sub>[?Yield, ?Await]</sub>  
**void** *UnaryExpression*<sub>[?Yield, ?Await]</sub>  
**typeof** *UnaryExpression*<sub>[?Yield, ?Await]</sub>  
 + *UnaryExpression*<sub>[?Yield, ?Await]</sub>  
 - *UnaryExpression*<sub>[?Yield, ?Await]</sub>  
 ~ *UnaryExpression*<sub>[?Yield, ?Await]</sub>  
 ! *UnaryExpression*<sub>[?Yield, ?Await]</sub>  
 [+Await] *AwaitExpression*<sub>[?Yield]</sub>

*ExponentiationExpression*<sub>[Yield, Await]</sub> :  
*UnaryExpression*<sub>[?Yield, ?Await]</sub>  
*UpdateExpression*<sub>[?Yield, ?Await]</sub> \*\* *ExponentiationExpression*<sub>[?Yield, ?Await]</sub>

*MultiplicativeExpression*<sub>[Yield, Await]</sub> :  
*ExponentiationExpression*<sub>[?Yield, ?Await]</sub>  
*MultiplicativeExpression*<sub>[?Yield, ?Await]</sub> *MultiplicativeOperator*  
*ExponentiationExpression*<sub>[?Yield, ?Await]</sub>

*MultiplicativeOperator* : **one of**  
 \* / %

```

AdditiveExpression[Yield, Await] :
    MultiplicativeExpression[?Yield, ?Await]
    AdditiveExpression[?Yield, ?Await] + MultiplicativeExpression[?Yield, ?Await]
    AdditiveExpression[?Yield, ?Await] - MultiplicativeExpression[?Yield, ?Await]
ShiftExpression[Yield, Await] :
    AdditiveExpression[?Yield, ?Await]
    ShiftExpression[?Yield, ?Await] << AdditiveExpression[?Yield, ?Await]
    ShiftExpression[?Yield, ?Await] >> AdditiveExpression[?Yield, ?Await]
    ShiftExpression[?Yield, ?Await] >>> AdditiveExpression[?Yield, ?Await]
RelationalExpression[In, Yield, Await] :
    ShiftExpression[?Yield, ?Await]
    RelationalExpression[?In, ?Yield, ?Await] < ShiftExpression[?Yield, ?Await]
    RelationalExpression[?In, ?Yield, ?Await] > ShiftExpression[?Yield, ?Await]
    RelationalExpression[?In, ?Yield, ?Await] <= ShiftExpression[?Yield, ?Await]
    RelationalExpression[?In, ?Yield, ?Await] >= ShiftExpression[?Yield, ?Await]
    RelationalExpression[?In, ?Yield, ?Await] instanceof ShiftExpression[?Yield, ?Await]
    [+In] RelationalExpression[+In, ?Yield, ?Await] in ShiftExpression[?Yield, ?Await]
    [+In] PrivateIdentifier in ShiftExpression[?Yield, ?Await]
EqualityExpression[In, Yield, Await] :
    RelationalExpression[?In, ?Yield, ?Await]
    EqualityExpression[?In, ?Yield, ?Await] == RelationalExpression[?In, ?Yield, ?Await]
    EqualityExpression[?In, ?Yield, ?Await] != RelationalExpression[?In, ?Yield, ?Await]
    EqualityExpression[?In, ?Yield, ?Await] === RelationalExpression[?In, ?Yield, ?Await]
    EqualityExpression[?In, ?Yield, ?Await] !== RelationalExpression[?In, ?Yield, ?Await]
BitwiseANDExpression[In, Yield, Await] :
    EqualityExpression[?In, ?Yield, ?Await]
    BitwiseANDExpression[?In, ?Yield, ?Await] & EqualityExpression[?In, ?Yield, ?Await]
BitwiseXORExpression[In, Yield, Await] :
    BitwiseANDExpression[?In, ?Yield, ?Await]
    BitwiseXORExpression[?In, ?Yield, ?Await] ^
        BitwiseANDExpression[?In, ?Yield, ?Await]
BitwiseORExpression[In, Yield, Await] :
    BitwiseXORExpression[?In, ?Yield, ?Await]
    BitwiseORExpression[?In, ?Yield, ?Await] | BitwiseXORExpression[?In, ?Yield, ?Await]
LogicalANDExpression[In, Yield, Await] :
    BitwiseORExpression[?In, ?Yield, ?Await]
    LogicalANDExpression[?In, ?Yield, ?Await] &&
        BitwiseORExpression[?In, ?Yield, ?Await]
LogicalORExpression[In, Yield, Await] :
    LogicalANDExpression[?In, ?Yield, ?Await]
    LogicalORExpression[?In, ?Yield, ?Await] ||
        LogicalANDExpression[?In, ?Yield, ?Await]
CoalesceExpression[In, Yield, Await] :
    CoalesceExpressionHead[?In, ?Yield, ?Await] ??
        BitwiseORExpression[?In, ?Yield, ?Await]

```

```

CoalesceExpressionHead[In, Yield, Await] :
    CoalesceExpression[?In, ?Yield, ?Await]
    BitwiseORExpression[?In, ?Yield, ?Await]
ShortCircuitExpression[In, Yield, Await] :
    LogicalORExpression[?In, ?Yield, ?Await]
    CoalesceExpression[?In, ?Yield, ?Await]
ConditionalExpression[In, Yield, Await] :
    ShortCircuitExpression[?In, ?Yield, ?Await]
    ShortCircuitExpression[?In, ?Yield, ?Await] ?
        AssignmentExpression[+In, ?Yield, ?Await] :
        AssignmentExpression[?In, ?Yield, ?Await]
AssignmentExpression[In, Yield, Await] :
    ConditionalExpression[?In, ?Yield, ?Await]
    [+Yield] YieldExpression[?In, ?Await]
    ArrowFunction[?In, ?Yield, ?Await]
    AsyncArrowFunction[?In, ?Yield, ?Await]
    LeftHandSideExpression[?Yield, ?Await] = AssignmentExpression[?In, ?Yield, ?Await]
    LeftHandSideExpression[?Yield, ?Await] AssignmentOperator
        AssignmentExpression[?In, ?Yield, ?Await]
    LeftHandSideExpression[?Yield, ?Await] &&= AssignmentExpression[?In, ?Yield, ?Await]
    LeftHandSideExpression[?Yield, ?Await] ||= AssignmentExpression[?In, ?Yield, ?Await]
    LeftHandSideExpression[?Yield, ?Await] ??= AssignmentExpression[?In, ?Yield, ?Await]
AssignmentOperator : one of
    *= /= %= += -= <<= >>= >>>= &= ^= |= **=

```

In certain circumstances when processing an instance of the production

```

AssignmentExpression[In, Yield, Await] :
    LeftHandSideExpression[?Yield, ?Await] = AssignmentExpression[?In, ?Yield, ?Await]

```

the interpretation of *LeftHandSideExpression* is refined using the following grammar:

```

AssignmentPattern[Yield, Await] :
    ObjectAssignmentPattern[?Yield, ?Await]
    ArrayAssignmentPattern[?Yield, ?Await]
ObjectAssignmentPattern[Yield, Await] :
    { }
    { AssignmentRestProperty[?Yield, ?Await] }
    { AssignmentPropertyList[?Yield, ?Await] }
    { AssignmentPropertyList[?Yield, ?Await] , AssignmentRestProperty[?Yield, ?Await] opt }
ArrayAssignmentPattern[Yield, Await] :
    [ Elisionopt AssignmentRestElement[?Yield, ?Await] opt ]
    [ AssignmentElementList[?Yield, ?Await] ]
    [ AssignmentElementList[?Yield, ?Await] , Elisionopt
        AssignmentRestElement[?Yield, ?Await] opt ]
AssignmentRestProperty[Yield, Await] :
    ... DestructuringAssignmentTarget[?Yield, ?Await]

```

*AssignmentPropertyList*<sub>[Yield, Await]</sub> :  
     *AssignmentProperty*<sub>[?Yield, ?Await]</sub>  
     *AssignmentPropertyList*<sub>[?Yield, ?Await]</sub> , *AssignmentProperty*<sub>[?Yield, ?Await]</sub>  
*AssignmentElementList*<sub>[Yield, Await]</sub> :  
     *AssignmentElisionElement*<sub>[?Yield, ?Await]</sub>  
     *AssignmentElementList*<sub>[?Yield, ?Await]</sub> , *AssignmentElisionElement*<sub>[?Yield, ?Await]</sub>  
*AssignmentElisionElement*<sub>[Yield, Await]</sub> :  
     *Elision*<sub>opt</sub> *AssignmentElement*<sub>[?Yield, ?Await]</sub>  
*AssignmentProperty*<sub>[Yield, Await]</sub> :  
     *IdentifierReference*<sub>[?Yield, ?Await]</sub> *Initializer*<sub>[+In, ?Yield, ?Await]</sub> *opt*  
     *PropertyName*<sub>[?Yield, ?Await]</sub> : *AssignmentElement*<sub>[?Yield, ?Await]</sub>  
*AssignmentElement*<sub>[Yield, Await]</sub> :  
     *DestructuringAssignmentTarget*<sub>[?Yield, ?Await]</sub> *Initializer*<sub>[+In, ?Yield, ?Await]</sub> *opt*  
*AssignmentRestElement*<sub>[Yield, Await]</sub> :  
     ... *DestructuringAssignmentTarget*<sub>[?Yield, ?Await]</sub>  
*DestructuringAssignmentTarget*<sub>[Yield, Await]</sub> :  
     *LeftHandSideExpression*<sub>[?Yield, ?Await]</sub>  
*Expression*<sub>[In, Yield, Await]</sub> :  
     *AssignmentExpression*<sub>[?In, ?Yield, ?Await]</sub>  
     *Expression*<sub>[?In, ?Yield, ?Await]</sub> , *AssignmentExpression*<sub>[?In, ?Yield, ?Await]</sub>

### A.3 Statements

*Statement*<sub>[Yield, Await, Return]</sub> :  
     *BlockStatement*<sub>[?Yield, ?Await, ?Return]</sub>  
     *VariableStatement*<sub>[?Yield, ?Await]</sub>  
     *EmptyStatement*  
     *ExpressionStatement*<sub>[?Yield, ?Await]</sub>  
     *IfStatement*<sub>[?Yield, ?Await, ?Return]</sub>  
     *BreakableStatement*<sub>[?Yield, ?Await, ?Return]</sub>  
     *ContinueStatement*<sub>[?Yield, ?Await]</sub>  
     *BreakStatement*<sub>[?Yield, ?Await]</sub>  
     [+Return] *ReturnStatement*<sub>[?Yield, ?Await]</sub>  
     *WithStatement*<sub>[?Yield, ?Await, ?Return]</sub>  
     *LabelledStatement*<sub>[?Yield, ?Await, ?Return]</sub>  
     *ThrowStatement*<sub>[?Yield, ?Await]</sub>  
     *TryStatement*<sub>[?Yield, ?Await, ?Return]</sub>  
     *DebuggerStatement*  
*Declaration*<sub>[Yield, Await]</sub> :  
     *HoistableDeclaration*<sub>[?Yield, ?Await, ~Default]</sub>  
     *ClassDeclaration*<sub>[?Yield, ?Await, ~Default]</sub>  
     *LexicalDeclaration*<sub>[+In, ?Yield, ?Await]</sub>  
*HoistableDeclaration*<sub>[Yield, Await, Default]</sub> :  
     *FunctionDeclaration*<sub>[?Yield, ?Await, ?Default]</sub>  
     *GeneratorDeclaration*<sub>[?Yield, ?Await, ?Default]</sub>

```

    AsyncFunctionDeclaration[?Yield, ?Await, ?Default]
    AsyncGeneratorDeclaration[?Yield, ?Await, ?Default]
BreakableStatement[Yield, Await, Return] :
    IterationStatement[?Yield, ?Await, ?Return]
    SwitchStatement[?Yield, ?Await, ?Return]
BlockStatement[Yield, Await, Return] :
    Block[?Yield, ?Await, ?Return]
Block[Yield, Await, Return] :
    { StatementList[?Yield, ?Await, ?Return] opt }
StatementList[Yield, Await, Return] :
    StatementListItem[?Yield, ?Await, ?Return]
    StatementList[?Yield, ?Await, ?Return] StatementListItem[?Yield, ?Await, ?Return]
StatementListItem[Yield, Await, Return] :
    Statement[?Yield, ?Await, ?Return]
    Declaration[?Yield, ?Await]
LexicalDeclaration[In, Yield, Await] :
    LetOrConst BindingList[?In, ?Yield, ?Await] ;
LetOrConst :
    let
    const
BindingList[In, Yield, Await] :
    LexicalBinding[?In, ?Yield, ?Await]
    BindingList[?In, ?Yield, ?Await] , LexicalBinding[?In, ?Yield, ?Await]
LexicalBinding[In, Yield, Await] :
    BindingIdentifier[?Yield, ?Await] Initializer[?In, ?Yield, ?Await] opt
    BindingPattern[?Yield, ?Await] Initializer[?In, ?Yield, ?Await]
VariableStatement[Yield, Await] :
    var VariableDeclarationList[+In, ?Yield, ?Await] ;
VariableDeclarationList[In, Yield, Await] :
    VariableDeclaration[?In, ?Yield, ?Await]
    VariableDeclarationList[?In, ?Yield, ?Await] , VariableDeclaration[?In, ?Yield, ?Await]
VariableDeclaration[In, Yield, Await] :
    BindingIdentifier[?Yield, ?Await] Initializer[?In, ?Yield, ?Await] opt
    BindingPattern[?Yield, ?Await] Initializer[?In, ?Yield, ?Await]
BindingPattern[Yield, Await] :
    ObjectBindingPattern[?Yield, ?Await]
    ArrayBindingPattern[?Yield, ?Await]
ObjectBindingPattern[Yield, Await] :
    { }
    { BindingRestProperty[?Yield, ?Await] }
    { BindingPropertyList[?Yield, ?Await] }
    { BindingPropertyList[?Yield, ?Await] , BindingRestProperty[?Yield, ?Await] opt }
ArrayBindingPattern[Yield, Await] :
    [ Elisionopt BindingRestElement[?Yield, ?Await] opt ]
    [ BindingElementList[?Yield, ?Await] ]

```

```

    [ BindingElementList[?Yield, ?Await] , Elisionopt
      BindingRestElement[?Yield, ?Await] opt ]
BindingRestProperty[Yield, Await] :
  ... BindingIdentifier[?Yield, ?Await]
BindingPropertyList[Yield, Await] :
  BindingProperty[?Yield, ?Await]
  BindingPropertyList[?Yield, ?Await] , BindingProperty[?Yield, ?Await]
BindingElementList[Yield, Await] :
  BindingElisionElement[?Yield, ?Await]
  BindingElementList[?Yield, ?Await] , BindingElisionElement[?Yield, ?Await]
BindingElisionElement[Yield, Await] :
  Elisionopt BindingElement[?Yield, ?Await]
BindingProperty[Yield, Await] :
  SingleNameBinding[?Yield, ?Await]
  PropertyName[?Yield, ?Await] : BindingElement[?Yield, ?Await]
BindingElement[Yield, Await] :
  SingleNameBinding[?Yield, ?Await]
  BindingPattern[?Yield, ?Await] Initializer[+In, ?Yield, ?Await] opt
SingleNameBinding[Yield, Await] :
  BindingIdentifier[?Yield, ?Await] Initializer[+In, ?Yield, ?Await] opt
BindingRestElement[Yield, Await] :
  ... BindingIdentifier[?Yield, ?Await]
  ... BindingPattern[?Yield, ?Await]
EmptyStatement :
  ;
ExpressionStatement[Yield, Await] :
  [lookahead ∉ { , function , async [no LineTerminator here] function , class , let [ ] ]
  Expression[+In, ?Yield, ?Await] ;
IfStatement[Yield, Await, Return] :
  if ( Expression[+In, ?Yield, ?Await] ) Statement[?Yield, ?Await, ?Return] else
  Statement[?Yield, ?Await, ?Return]
  if ( Expression[+In, ?Yield, ?Await] ) Statement[?Yield, ?Await, ?Return] [lookahead
  ≠ else]
IterationStatement[Yield, Await, Return] :
  DoWhileStatement[?Yield, ?Await, ?Return]
  WhileStatement[?Yield, ?Await, ?Return]
  ForStatement[?Yield, ?Await, ?Return]
  ForInOfStatement[?Yield, ?Await, ?Return]
DoWhileStatement[Yield, Await, Return] :
  do Statement[?Yield, ?Await, ?Return] while ( Expression[+In, ?Yield, ?Await] ) ;
WhileStatement[Yield, Await, Return] :
  while ( Expression[+In, ?Yield, ?Await] ) Statement[?Yield, ?Await, ?Return]
ForStatement[Yield, Await, Return] :
  for ( [lookahead ≠ let [ ] Expression[~In, ?Yield, ?Await] opt ;
  Expression[+In, ?Yield, ?Await] opt ; Expression[+In, ?Yield, ?Await] opt )
  Statement[?Yield, ?Await, ?Return]

```



```

for ( var VariableDeclarationList[~In, ?Yield, ?Await] ;
      Expression[+In, ?Yield, ?Await] opt ; Expression[+In, ?Yield, ?Await] opt )
  Statement[?Yield, ?Await, ?Return]
for ( LexicalDeclaration[~In, ?Yield, ?Await] Expression[+In, ?Yield, ?Await] opt ;
      Expression[+In, ?Yield, ?Await] opt ) Statement[?Yield, ?Await, ?Return]
ForInOfStatement[Yield, Await, Return] :
  for ( [lookahead ≠ let] LeftHandSideExpression[?Yield, ?Await] in
        Expression[+In, ?Yield, ?Await] ) Statement[?Yield, ?Await, ?Return]
  for ( var ForBinding[?Yield, ?Await] in Expression[+In, ?Yield, ?Await] )
        Statement[?Yield, ?Await, ?Return]
  for ( ForDeclaration[?Yield, ?Await] in Expression[+In, ?Yield, ?Await] )
        Statement[?Yield, ?Await, ?Return]
  for ( [lookahead ∉ { let, async of } ] LeftHandSideExpression[?Yield, ?Await] of
        AssignmentExpression[+In, ?Yield, ?Await] ) Statement[?Yield, ?Await, ?Return]
  for ( var ForBinding[?Yield, ?Await] of AssignmentExpression[+In, ?Yield, ?Await] )
        Statement[?Yield, ?Await, ?Return]
  for ( ForDeclaration[?Yield, ?Await] of AssignmentExpression[+In, ?Yield, ?Await] )
        Statement[?Yield, ?Await, ?Return]
  [+Await] for await ( [lookahead ≠ let] LeftHandSideExpression[?Yield, ?Await] of
        AssignmentExpression[+In, ?Yield, ?Await] ) Statement[?Yield, ?Await, ?Return]
  [+Await] for await ( var ForBinding[?Yield, ?Await] of
        AssignmentExpression[+In, ?Yield, ?Await] ) Statement[?Yield, ?Await, ?Return]
  [+Await] for await ( ForDeclaration[?Yield, ?Await] of
        AssignmentExpression[+In, ?Yield, ?Await] ) Statement[?Yield, ?Await, ?Return]
ForDeclaration[Yield, Await] :
  LetOrConst ForBinding[?Yield, ?Await]
ForBinding[Yield, Await] :
  BindingIdentifier[?Yield, ?Await]
  BindingPattern[?Yield, ?Await]
ContinueStatement[Yield, Await] :
  continue ;
  continue [no LineTerminator here] LabelIdentifier[?Yield, ?Await] ;
BreakStatement[Yield, Await] :
  break ;
  break [no LineTerminator here] LabelIdentifier[?Yield, ?Await] ;
ReturnStatement[Yield, Await] :
  return ;
  return [no LineTerminator here] Expression[+In, ?Yield, ?Await] ;
WithStatement[Yield, Await, Return] :
  with ( Expression[+In, ?Yield, ?Await] ) Statement[?Yield, ?Await, ?Return]
SwitchStatement[Yield, Await, Return] :
  switch ( Expression[+In, ?Yield, ?Await] ) CaseBlock[?Yield, ?Await, ?Return]
CaseBlock[Yield, Await, Return] :
  { CaseClauses[?Yield, ?Await, ?Return] opt }
  { CaseClauses[?Yield, ?Await, ?Return] opt DefaultClause[?Yield, ?Await, ?Return]
    CaseClauses[?Yield, ?Await, ?Return] opt }

```

```

CaseClauses[Yield, Await, Return] :
    CaseClause[?Yield, ?Await, ?Return]
    CaseClauses[?Yield, ?Await, ?Return] CaseClause[?Yield, ?Await, ?Return]
CaseClause[Yield, Await, Return] :
    case Expression[+In, ?Yield, ?Await] : StatementList[?Yield, ?Await, ?Return] opt
DefaultClause[Yield, Await, Return] :
    default : StatementList[?Yield, ?Await, ?Return] opt
LabelledStatement[Yield, Await, Return] :
    LabelIdentifier[?Yield, ?Await] : LabelledItem[?Yield, ?Await, ?Return]
LabelledItem[Yield, Await, Return] :
    Statement[?Yield, ?Await, ?Return]
    FunctionDeclaration[?Yield, ?Await, ~Default]
ThrowStatement[Yield, Await] :
    throw [no LineTerminator here] Expression[+In, ?Yield, ?Await] ;
TryStatement[Yield, Await, Return] :
    try Block[?Yield, ?Await, ?Return] Catch[?Yield, ?Await, ?Return]
    try Block[?Yield, ?Await, ?Return] Finally[?Yield, ?Await, ?Return]
    try Block[?Yield, ?Await, ?Return] Catch[?Yield, ?Await, ?Return]
    Finally[?Yield, ?Await, ?Return]
Catch[Yield, Await, Return] :
    catch ( CatchParameter[?Yield, ?Await] ) Block[?Yield, ?Await, ?Return]
    catch Block[?Yield, ?Await, ?Return]
Finally[Yield, Await, Return] :
    finally Block[?Yield, ?Await, ?Return]
CatchParameter[Yield, Await] :
    BindingIdentifier[?Yield, ?Await]
    BindingPattern[?Yield, ?Await]
DebuggerStatement :
    debugger ;

```

## A.4 Functions and Classes

```

UniqueFormalParameters[Yield, Await] :
    FormalParameters[?Yield, ?Await]
FormalParameters[Yield, Await] :
    [empty]
    FunctionRestParameter[?Yield, ?Await]
    FormalParameterList[?Yield, ?Await]
    FormalParameterList[?Yield, ?Await] ,
    FormalParameterList[?Yield, ?Await] , FunctionRestParameter[?Yield, ?Await]
FormalParameterList[Yield, Await] :
    FormalParameter[?Yield, ?Await]
    FormalParameterList[?Yield, ?Await] , FormalParameter[?Yield, ?Await]
FunctionRestParameter[Yield, Await] :
    BindingRestElement[?Yield, ?Await]

```

```

FormalParameter[Yield, Await] :
    BindingElement[?Yield, ?Await]
FunctionDeclaration[Yield, Await, Default] :
    function BindingIdentifier[?Yield, ?Await] ( FormalParameters[~Yield, ~Await] ) {
        FunctionBody[~Yield, ~Await] }
    [+Default] function ( FormalParameters[~Yield, ~Await] ) {
        FunctionBody[~Yield, ~Await] }
FunctionExpression :
    function BindingIdentifier[~Yield, ~Await] opt ( FormalParameters[~Yield, ~Await] ) {
        FunctionBody[~Yield, ~Await] }
FunctionBody[Yield, Await] :
    FunctionStatementList[?Yield, ?Await]
FunctionStatementList[Yield, Await] :
    StatementList[?Yield, ?Await, +Return] opt
ArrowFunction[In, Yield, Await] :
    ArrowParameters[?Yield, ?Await] [no LineTerminator here] => ConciseBody[?In]
ArrowParameters[Yield, Await] :
    BindingIdentifier[?Yield, ?Await]
    CoverParenthesizedExpressionAndArrowParameterList[?Yield, ?Await]
ConciseBody[In] :
    [lookahead ≠ {] ExpressionBody[?In, ~Await]
    { FunctionBody[~Yield, ~Await] }
ExpressionBody[In, Await] :
    AssignmentExpression[?In, ~Yield, ?Await]

```

When processing an instance of the production

```

ArrowParameters[Yield, Await] :
    CoverParenthesizedExpressionAndArrowParameterList[?Yield, ?Await]

```

the interpretation of *CoverParenthesizedExpressionAndArrowParameterList* is refined using the following grammar:

```

ArrowFormalParameters[Yield, Await] :
    ( UniqueFormalParameters[?Yield, ?Await] )
AsyncArrowFunction[In, Yield, Await] :
    async [no LineTerminator here] AsyncArrowBindingIdentifier[?Yield] [no LineTerminator here]
    => AsyncConciseBody[?In]
    CoverCallExpressionAndAsyncArrowHead[?Yield, ?Await] [no LineTerminator here] =>
        AsyncConciseBody[?In]
AsyncConciseBody[In] :
    [lookahead ≠ {] ExpressionBody[?In, +Await]
    { AsyncFunctionBody }
AsyncArrowBindingIdentifier[Yield] :
    BindingIdentifier[?Yield, +Await]
CoverCallExpressionAndAsyncArrowHead[Yield, Await] :
    MemberExpression[?Yield, ?Await] Arguments[?Yield, ?Await]

```

When processing an instance of the production

```
AsyncArrowFunction[In, Yield, Await] :
  CoverCallExpressionAndAsyncArrowHead[?Yield, ?Await] [no LineTerminator here] =>
  AsyncConciseBody[?In]
```

the interpretation of *CoverCallExpressionAndAsyncArrowHead* is refined using the following grammar:

*AsyncArrowHead* :

```
  async [no LineTerminator here] ArrowFormalParameters[~Yield, +Await]
```

*MethodDefinition*<sub>[Yield, Await]</sub> :

```
  ClassElementName[?Yield, ?Await] ( UniqueFormalParameters[~Yield, ~Await] ) {
    FunctionBody[~Yield, ~Await] }
  GeneratorMethod[?Yield, ?Await]
  AsyncMethod[?Yield, ?Await]
  AsyncGeneratorMethod[?Yield, ?Await]
  get ClassElementName[?Yield, ?Await] ( ) { FunctionBody[~Yield, ~Await] }
  set ClassElementName[?Yield, ?Await] ( PropertySetParameterList ) {
    FunctionBody[~Yield, ~Await] }
```

*PropertySetParameterList* :

```
  FormalParameter[~Yield, ~Await]
```

*GeneratorDeclaration*<sub>[Yield, Await, Default]</sub> :

```
  function * BindingIdentifier[?Yield, ?Await] ( FormalParameters[+Yield, ~Await] ) {
    GeneratorBody }
  [+Default] function * ( FormalParameters[+Yield, ~Await] ) { GeneratorBody }
```

*GeneratorExpression* :

```
  function * BindingIdentifier[+Yield, ~Await] opt ( FormalParameters[+Yield, ~Await] )
  { GeneratorBody }
```

*GeneratorMethod*<sub>[Yield, Await]</sub> :

```
  * ClassElementName[?Yield, ?Await] ( UniqueFormalParameters[+Yield, ~Await] ) {
    GeneratorBody }
```

*GeneratorBody* :

```
  FunctionBody[+Yield, ~Await]
```

*YieldExpression*<sub>[In, Await]</sub> :

```
  yield
  yield [no LineTerminator here] AssignmentExpression[?In, +Yield, ?Await]
  yield [no LineTerminator here] * AssignmentExpression[?In, +Yield, ?Await]
```

*AsyncGeneratorDeclaration*<sub>[Yield, Await, Default]</sub> :

```
  async [no LineTerminator here] function * BindingIdentifier[?Yield, ?Await] (
    FormalParameters[+Yield, +Await] ) { AsyncGeneratorBody }
  [+Default] async [no LineTerminator here] function * ( FormalParameters[+Yield, +Await]
  ) { AsyncGeneratorBody }
```

*AsyncGeneratorExpression* :

```
  async [no LineTerminator here] function * BindingIdentifier[+Yield, +Await] opt (
    FormalParameters[+Yield, +Await] ) { AsyncGeneratorBody }
```

*AsyncGeneratorMethod*<sub>[Yield, Await]</sub> :

```
  async [no LineTerminator here] * ClassElementName[?Yield, ?Await] (
    UniqueFormalParameters[+Yield, +Await] ) { AsyncGeneratorBody }
```

*AsyncGeneratorBody* :

```
  FunctionBody[+Yield, +Await]
```

```

AsyncFunctionDeclaration[Yield, Await, Default] :
    async [no LineTerminator here] function BindingIdentifier[?Yield, ?Await] (
        FormalParameters[~Yield, +Await] ) { AsyncFunctionBody }
    [+Default] async [no LineTerminator here] function ( FormalParameters[~Yield, +Await] )
        { AsyncFunctionBody }
AsyncFunctionExpression :
    async [no LineTerminator here] function BindingIdentifier[~Yield, +Await] opt (
        FormalParameters[~Yield, +Await] ) { AsyncFunctionBody }
AsyncMethod[Yield, Await] :
    async [no LineTerminator here] ClassElementName[?Yield, ?Await] (
        UniqueFormalParameters[~Yield, +Await] ) { AsyncFunctionBody }
AsyncFunctionBody :
    FunctionBody[~Yield, +Await]
AwaitExpression[Yield] :
    await UnaryExpression[?Yield, +Await]
ClassDeclaration[Yield, Await, Default] :
    class BindingIdentifier[?Yield, ?Await] ClassTail[?Yield, ?Await]
    [+Default] class ClassTail[?Yield, ?Await]
ClassExpression[Yield, Await] :
    class BindingIdentifier[?Yield, ?Await] opt ClassTail[?Yield, ?Await]
ClassTail[Yield, Await] :
    ClassHeritage[?Yield, ?Await] opt { ClassBody[?Yield, ?Await] opt }
ClassHeritage[Yield, Await] :
    extends LeftHandSideExpression[?Yield, ?Await]
ClassBody[Yield, Await] :
    ClassElementList[?Yield, ?Await]
ClassElementList[Yield, Await] :
    ClassElement[?Yield, ?Await]
    ClassElementList[?Yield, ?Await] ClassElement[?Yield, ?Await]
ClassElement[Yield, Await] :
    MethodDefinition[?Yield, ?Await]
    static MethodDefinition[?Yield, ?Await]
    FieldDefinition[?Yield, ?Await] ;
    static FieldDefinition[?Yield, ?Await] ;
    ClassStaticBlock
    ;
FieldDefinition[Yield, Await] :
    ClassElementName[?Yield, ?Await] Initializer[+In, ?Yield, ?Await] opt
ClassElementName[Yield, Await] :
    PropertyName[?Yield, ?Await]
    PrivateIdentifier
ClassStaticBlock :
    static { ClassStaticBlockBody }
ClassStaticBlockBody :
    ClassStaticBlockStatementList
ClassStaticBlockStatementList :
    StatementList[~Yield, +Await, ~Return] opt

```

## A.5 Scripts and Modules

```

Script :
    ScriptBodyopt
ScriptBody :
    StatementList[~Yield, ~Await, ~Return]
Module :
    ModuleBodyopt
ModuleBody :
    ModuleItemList
ModuleItemList :
    ModuleItem
    ModuleItemList ModuleItem
ModuleItem :
    ImportDeclaration
    ExportDeclaration
    StatementListItem[~Yield, +Await, ~Return]
ModuleExportName :
    IdentifierName
    StringLiteral
ImportDeclaration :
    import ImportClause FromClause ;
    import ModuleSpecifier ;
ImportClause :
    ImportedDefaultBinding
    NameSpaceImport
    NamedImports
    ImportedDefaultBinding , NameSpaceImport
    ImportedDefaultBinding , NamedImports
ImportedDefaultBinding :
    ImportedBinding
NameSpaceImport :
    * as ImportedBinding
NamedImports :
    { }
    { ImportsList }
    { ImportsList , }
FromClause :
    from ModuleSpecifier
ImportsList :
    ImportSpecifier
    ImportsList , ImportSpecifier
ImportSpecifier :
    ImportedBinding
    ModuleExportName as ImportedBinding
ModuleSpecifier :
    StringLiteral
ImportedBinding :
    BindingIdentifier[~Yield, +Await]
ExportDeclaration :
    export ExportFromClause FromClause ;
    export NamedExports ;
    export VariableStatement[~Yield, +Await]
    export Declaration[~Yield, +Await]

```

```

export default HoistableDeclaration[~Yield, +Await, +Default]
export default ClassDeclaration[~Yield, +Await, +Default]
export default [lookahead ∉ { function , async [no LineTerminator here] function ,
  class }] AssignmentExpression[+In, ~Yield, +Await] ;

```

*ExportFromClause* :

```

*
* as ModuleExportName
  NamedExports

```

*NamedExports* :

```

{ }
{ ExportsList }
{ ExportsList , }

```

*ExportsList* :

```

ExportSpecifier
ExportsList , ExportSpecifier

```

*ExportSpecifier* :

```

ModuleExportName
ModuleExportName as ModuleExportName

```

## A.6 Number Conversions

*StringNumericLiteral* :::

```

  StrWhiteSpaceopt
  StrWhiteSpaceopt StrNumericLiteral StrWhiteSpaceopt

```

*StrWhiteSpace* :::

```

  StrWhiteSpaceChar StrWhiteSpaceopt

```

*StrWhiteSpaceChar* :::

```

  WhiteSpace
  LineTerminator

```

*StrNumericLiteral* :::

```

  StrDecimalLiteral
  NonDecimalIntegerLiteral[~Sep]

```

*StrDecimalLiteral* :::

```

  StrUnsignedDecimalLiteral
  + StrUnsignedDecimalLiteral
  - StrUnsignedDecimalLiteral

```

*StrUnsignedDecimalLiteral* :::

```

Infinity
  DecimalDigits[~Sep] . DecimalDigits[~Sep]opt ExponentPart[~Sep]opt
  . DecimalDigits[~Sep] ExponentPart[~Sep]opt
  DecimalDigits[~Sep] ExponentPart[~Sep]opt

```

All grammar symbols not explicitly defined by the *StringNumericLiteral* grammar have the definitions used in the [Lexical Grammar for numeric literals](#).

*StringIntegerLiteral* :::

```

  StrWhiteSpaceopt
  StrWhiteSpaceopt StrIntegerLiteral StrWhiteSpaceopt

```

*StrIntegerLiteral* :::

```

  SignedInteger[~Sep]
  NonDecimalIntegerLiteral[~Sep]

```

## A.7 Time Zone Offset String Format

*UTCOffset* :::  
*TemporalSign* *Hour*  
*TemporalSign* *Hour* *HourSubcomponents*<sub>[+Extended]</sub>  
*TemporalSign* *Hour* *HourSubcomponents*<sub>[-Extended]</sub>

*TemporalSign* :::  
*ASCIISign*  
 <MINUS>

*ASCIISign* ::: **one of**  
 + -

*Hour* :::  
 0 *DecimalDigit*  
 1 *DecimalDigit*  
 20  
 21  
 22  
 23

*HourSubcomponents*<sub>[Extended]</sub> :::  
*TimeSeparator*<sub>[?Extended]</sub> *MinuteSecond*  
*TimeSeparator*<sub>[?Extended]</sub> *MinuteSecond* *TimeSeparator*<sub>[?Extended]</sub> *MinuteSecond*  
*TemporalDecimalFraction*<sub>opt</sub>

*TimeSeparator*<sub>[Extended]</sub> :::  
<sub>[+Extended]</sub> :  
<sub>[-Extended]</sub> [empty]

*MinuteSecond* :::  
 0 *DecimalDigit*  
 1 *DecimalDigit*  
 2 *DecimalDigit*  
 3 *DecimalDigit*  
 4 *DecimalDigit*  
 5 *DecimalDigit*

*TemporalDecimalFraction* :::  
*TemporalDecimalSeparator* *DecimalDigit*  
*TemporalDecimalSeparator* *DecimalDigit* *DecimalDigit*  
*TemporalDecimalSeparator* *DecimalDigit* *DecimalDigit* *DecimalDigit*  
*TemporalDecimalSeparator* *DecimalDigit* *DecimalDigit* *DecimalDigit* *DecimalDigit*  
*TemporalDecimalSeparator* *DecimalDigit* *DecimalDigit* *DecimalDigit* *DecimalDigit* *DecimalDigit*  
*TemporalDecimalSeparator* *DecimalDigit* *DecimalDigit* *DecimalDigit* *DecimalDigit* *DecimalDigit* *DecimalDigit*  
*TemporalDecimalSeparator* *DecimalDigit* *DecimalDigit* *DecimalDigit* *DecimalDigit* *DecimalDigit* *DecimalDigit* *DecimalDigit*  
*TemporalDecimalSeparator* *DecimalDigit* *DecimalDigit* *DecimalDigit* *DecimalDigit* *DecimalDigit* *DecimalDigit* *DecimalDigit* *DecimalDigit*  
*TemporalDecimalSeparator* *DecimalDigit* *DecimalDigit* *DecimalDigit* *DecimalDigit* *DecimalDigit* *DecimalDigit* *DecimalDigit* *DecimalDigit* *DecimalDigit*  
*TemporalDecimalSeparator* *DecimalDigit* *DecimalDigit* *DecimalDigit* *DecimalDigit* *DecimalDigit* *DecimalDigit* *DecimalDigit* *DecimalDigit* *DecimalDigit* *DecimalDigit*

*TemporalDecimalSeparator* ::: **one of**  
 . ,

## A.8 Regular Expressions

*Pattern*<sub>[UnicodeMode, N]</sub> :::  
*Disjunction*<sub>[?UnicodeMode, ?N]</sub>



```

Disjunction[UnicodeMode, N] ::
    Alternative[?UnicodeMode, ?N]
    Alternative[?UnicodeMode, ?N] | Disjunction[?UnicodeMode, ?N]
Alternative[UnicodeMode, N] ::
    [empty]
    Alternative[?UnicodeMode, ?N] Term[?UnicodeMode, ?N]
Term[UnicodeMode, N] ::
    Assertion[?UnicodeMode, ?N]
    Atom[?UnicodeMode, ?N]
    Atom[?UnicodeMode, ?N] Quantifier
Assertion[UnicodeMode, N] ::
    ^
    $
    \b
    \B
    (?= Disjunction[?UnicodeMode, ?N] )
    (?! Disjunction[?UnicodeMode, ?N] )
    (?<= Disjunction[?UnicodeMode, ?N] )
    (?<! Disjunction[?UnicodeMode, ?N] )
Quantifier ::
    QuantifierPrefix
    QuantifierPrefix ?
QuantifierPrefix ::
    *
    +
    ?
    { DecimalDigits[~Sep] }
    { DecimalDigits[~Sep] , }
    { DecimalDigits[~Sep] , DecimalDigits[~Sep] }
Atom[UnicodeMode, N] ::
    PatternCharacter
    .
    \ AtomEscape[?UnicodeMode, ?N]
    CharacterClass[?UnicodeMode]
    ( GroupSpecifier[?UnicodeMode] opt Disjunction[?UnicodeMode, ?N] )
    (? : Disjunction[?UnicodeMode, ?N] )
SyntaxCharacter :: one of
    ^ $ \ . * + ? ( ) [ ] { } |
PatternCharacter ::
    SourceCharacter but not SyntaxCharacter
AtomEscape[UnicodeMode, N] ::
    DecimalEscape
    CharacterClassEscape[?UnicodeMode]
    CharacterEscape[?UnicodeMode]
    [+N] k GroupName[?UnicodeMode]
CharacterEscape[UnicodeMode] ::
    ControlEscape
    c AsciiLetter

```

```

    0 [lookahead ∉ DecimalDigit]
    HexEscapeSequence
    RegExpUnicodeEscapeSequence [?UnicodeMode]
    IdentityEscape [?UnicodeMode]
ControlEscape :: one of
    f n r t v
GroupSpecifier [UnicodeMode] ::
    ? GroupName [?UnicodeMode]
GroupName [UnicodeMode] ::
    < RegExpIdentifierName [?UnicodeMode] >
RegExpIdentifierName [UnicodeMode] ::
    RegExpIdentifierStart [?UnicodeMode]
    RegExpIdentifierName [?UnicodeMode] RegExpIdentifierPart [?UnicodeMode]
RegExpIdentifierStart [UnicodeMode] ::
    IdentifierStartChar
    \ RegExpUnicodeEscapeSequence [+UnicodeMode]
    [~UnicodeMode] UnicodeLeadSurrogate UnicodeTrailSurrogate
RegExpIdentifierPart [UnicodeMode] ::
    IdentifierPartChar
    \ RegExpUnicodeEscapeSequence [+UnicodeMode]
    [~UnicodeMode] UnicodeLeadSurrogate UnicodeTrailSurrogate
RegExpUnicodeEscapeSequence [UnicodeMode] ::
    [+UnicodeMode] u HexLeadSurrogate \u HexTrailSurrogate
    [+UnicodeMode] u HexLeadSurrogate
    [+UnicodeMode] u HexTrailSurrogate
    [+UnicodeMode] u HexNonSurrogate
    [~UnicodeMode] u Hex4Digits
    [+UnicodeMode] u{ CodePoint }
UnicodeLeadSurrogate ::
    any Unicode code point in the inclusive interval from U+D800 to U+DBFF
UnicodeTrailSurrogate ::
    any Unicode code point in the inclusive interval from U+DC00 to U+DFFF

```

Each `\u HexTrailSurrogate` for which the choice of associated `u HexLeadSurrogate` is ambiguous shall be associated with the nearest possible `u HexLeadSurrogate` that would otherwise have no corresponding `\u HexTrailSurrogate`.

```

HexLeadSurrogate ::
    Hex4Digits but only if the MV of Hex4Digits is in the inclusive interval from 0xD800 to 0xDBFF
HexTrailSurrogate ::
    Hex4Digits but only if the MV of Hex4Digits is in the inclusive interval from 0xDC00 to 0xDFFF
HexNonSurrogate ::
    Hex4Digits but only if the MV of Hex4Digits is not in the inclusive interval from 0xD800 to 0xDFFF
IdentityEscape [UnicodeMode] ::
    [+UnicodeMode] SyntaxCharacter
    [+UnicodeMode] /
    [~UnicodeMode] SourceCharacter but not UnicodeIDContinue
DecimalEscape ::
    NonZeroDigit DecimalDigits [~Sep] opt [lookahead ∉ DecimalDigit]

```

```

CharacterClassEscape[UnicodeMode] ::
    d
    D
    s
    S
    w
    W
    [+UnicodeMode] P{ UnicodePropertyValueExpression }
    [+UnicodeMode] P{ UnicodePropertyValueExpression }
UnicodePropertyValueExpression ::
    UnicodePropertyName = UnicodePropertyValue
    LoneUnicodePropertyNameOrValue
UnicodePropertyName ::
    UnicodePropertyNameCharacters
UnicodePropertyNameCharacters ::
    UnicodePropertyNameCharacter UnicodePropertyNameCharactersopt
UnicodePropertyValue ::
    UnicodePropertyValueCharacters
LoneUnicodePropertyNameOrValue ::
    UnicodePropertyValueCharacters
UnicodePropertyValueCharacters ::
    UnicodePropertyValueCharacter UnicodePropertyValueCharactersopt
UnicodePropertyValueCharacter ::
    UnicodePropertyNameCharacter
    DecimalDigit
UnicodePropertyNameCharacter ::
    AsciiLetter

-
CharacterClass[UnicodeMode] ::
    [ [lookahead ≠ ^] ClassRanges[?UnicodeMode] ]
    [ ^ ClassRanges[?UnicodeMode] ]
ClassRanges[UnicodeMode] ::
    [empty]
    NonemptyClassRanges[?UnicodeMode]
NonemptyClassRanges[UnicodeMode] ::
    ClassAtom[?UnicodeMode]
    ClassAtom[?UnicodeMode] NonemptyClassRangesNoDash[?UnicodeMode]
    ClassAtom[?UnicodeMode] - ClassAtom[?UnicodeMode] ClassRanges[?UnicodeMode]
NonemptyClassRangesNoDash[UnicodeMode] ::
    ClassAtom[?UnicodeMode]
    ClassAtomNoDash[?UnicodeMode] NonemptyClassRangesNoDash[?UnicodeMode]
    ClassAtomNoDash[?UnicodeMode] - ClassAtom[?UnicodeMode] ClassRanges[?UnicodeMode]
ClassAtom[UnicodeMode] ::
    -
    ClassAtomNoDash[?UnicodeMode]
ClassAtomNoDash[UnicodeMode] ::
    SourceCharacter but not one of \ or ] or -
    \ ClassEscape[?UnicodeMode]
ClassEscape[UnicodeMode] ::
    b

```

[+UnicodeMode] -

*CharacterClassEscape* [ ?UnicodeMode ]

*CharacterEscape* [ ?UnicodeMode ]

## Annex B

(normative)

### Additional ECMAScript Features for Web Browsers

The ECMAScript language syntax and semantics defined in this annex are required when the ECMAScript [host](#) is a web browser. The content of this annex is normative but optional if the ECMAScript [host](#) is not a web browser.

**NOTE** This annex describes various legacy features and other characteristics of web browser ECMAScript [hosts](#). All of the language features and behaviours specified in this annex have one or more undesirable characteristics and in the absence of legacy usage would be removed from this specification. However, the usage of these features by large numbers of existing web pages means that web browsers must continue to support them. The specifications in this annex define the requirements for interoperable implementations of these legacy features.

These features are not considered part of the core ECMAScript language. Programmers should not use or assume the existence of these features and behaviours when writing new ECMAScript code. ECMAScript implementations are discouraged from implementing these features unless the implementation is part of a web browser or is required to run the same legacy ECMAScript code that web browsers encounter.

#### B.1 Additional Syntax

##### B.1.1 HTML-like Comments

The syntax and semantics of [12.4](#) is extended as follows except that this extension is not allowed when parsing source text using the [goal symbol Module](#):

##### Syntax

*Comment* ::

*MultiLineComment*  
*SingleLineComment*  
*SingleLineHTMLOpenComment*  
*SingleLineHTMLCloseComment*  
*SingleLineDelimitedComment*

*MultiLineComment* ::

*/\* FirstCommentLine*<sub>opt</sub> *LineTerminator MultiLineCommentChars*<sub>opt</sub> *\*/*  
*HTMLCloseComment*<sub>opt</sub>

```

FirstCommentLine ::
    SingleLineDelimitedCommentChars

SingleLineHTMLOpenComment ::
    <!-- SingleLineCommentCharsopt

SingleLineHTMLCloseComment ::
    LineTerminatorSequence HTMLCloseComment

SingleLineDelimitedComment ::
    /* SingleLineDelimitedCommentCharsopt */

HTMLCloseComment ::
    WhiteSpaceSequenceopt SingleLineDelimitedCommentSequenceopt -->
    SingleLineCommentCharsopt

SingleLineDelimitedCommentChars ::
    SingleLineNotAsteriskChar SingleLineDelimitedCommentCharsopt
    * SingleLinePostAsteriskCommentCharsopt

SingleLineNotAsteriskChar ::
    SourceCharacter but not one of * or LineTerminator

SingleLinePostAsteriskCommentChars ::
    SingleLineNotForwardSlashOrAsteriskChar SingleLineDelimitedCommentCharsopt
    * SingleLinePostAsteriskCommentCharsopt

SingleLineNotForwardSlashOrAsteriskChar ::
    SourceCharacter but not one of / or * or LineTerminator

WhiteSpaceSequence ::
    WhiteSpace WhiteSpaceSequenceopt

SingleLineDelimitedCommentSequence ::
    SingleLineDelimitedComment WhiteSpaceSequenceopt
    SingleLineDelimitedCommentSequenceopt

```

Similar to a *MultiLineComment* that contains a line terminator code point, a *SingleLineHTMLCloseComment* is considered to be a *LineTerminator* for purposes of parsing by the syntactic grammar.

## B.1.2 Regular Expressions Patterns

The syntax of 22.2.1 is modified and extended as follows. These changes introduce ambiguities that are broken by the ordering of grammar productions and by contextual information. When parsing using the following grammar, each alternative is considered only if previous production alternatives do not match.

This alternative pattern grammar and semantics only changes the syntax and semantics of BMP patterns. The following grammar extensions include productions parameterized with the [UnicodeMode] parameter. However, none of these extensions change the syntax of Unicode patterns recognized when parsing with the [UnicodeMode] parameter present on the [goal symbol](#).

### Syntax

```

Term[UnicodeMode, N] ::
    [+UnicodeMode] Assertion[+UnicodeMode, ?N]
    [+UnicodeMode] Atom[+UnicodeMode, ?N] Quantifier

```

```

[+UnicodeMode] Atom[+UnicodeMode, ?N]
[~UnicodeMode] QuantifiableAssertion[?N] Quantifier
[~UnicodeMode] Assertion[~UnicodeMode, ?N]
[~UnicodeMode] ExtendedAtom[?N] Quantifier
[~UnicodeMode] ExtendedAtom[?N]

```

```

Assertion[UnicodeMode, N] ::
^
$
\b
\B
[+UnicodeMode] (?= Disjunction[+UnicodeMode, ?N] )
[+UnicodeMode] (?! Disjunction[+UnicodeMode, ?N] )
[~UnicodeMode] QuantifiableAssertion[?N]
(?<= Disjunction[?UnicodeMode, ?N] )
(?<! Disjunction[?UnicodeMode, ?N] )

```

```

QuantifiableAssertion[N] ::
(?= Disjunction[~UnicodeMode, ?N] )
(?! Disjunction[~UnicodeMode, ?N] )

```

```

ExtendedAtom[N] ::
.
\ AtomEscape[~UnicodeMode, ?N]
\ [lookahead = c]
CharacterClass[~UnicodeMode]
( GroupSpecifier[~UnicodeMode] opt Disjunction[~UnicodeMode, ?N] )
(?: Disjunction[~UnicodeMode, ?N] )
InvalidBracedQuantifier
ExtendedPatternCharacter

```

```

InvalidBracedQuantifier ::
{ DecimalDigits[~Sep] }
{ DecimalDigits[~Sep] , }
{ DecimalDigits[~Sep] , DecimalDigits[~Sep] }

```

```

ExtendedPatternCharacter ::
SourceCharacter but not one of ^ $ \ . * + ? ( ) [ |

```

```

AtomEscape[UnicodeMode, N] ::
[+UnicodeMode] DecimalEscape
[~UnicodeMode] DecimalEscape but only if the CapturingGroupNumber of DecimalEscape is ≤
CountLeftCapturingParensWithin(the Pattern containing DecimalEscape )
CharacterClassEscape[?UnicodeMode]
CharacterEscape[?UnicodeMode, ?N]
[+N] k GroupName[?UnicodeMode]

```

```

CharacterEscape[UnicodeMode, N] ::
ControlEscape
c AsciiLetter
o [lookahead ≠ DecimalDigit]

```

*HexEscapeSequence*  
*RegExpUnicodeEscapeSequence*<sub>[?UnicodeMode]</sub>  
<sub>[~UnicodeMode]</sub> *LegacyOctalEscapeSequence*  
*IdentityEscape*<sub>[?UnicodeMode, ?N]</sub>

*IdentityEscape*<sub>[UnicodeMode, N]</sub> ::  
<sub>[+UnicodeMode]</sub> *SyntaxCharacter*  
<sub>[+UnicodeMode]</sub> /  
<sub>[~UnicodeMode]</sub> *SourceCharacterIdentityEscape*<sub>[?N]</sub>

*SourceCharacterIdentityEscape*<sub>[N]</sub> ::  
<sub>[~N]</sub> *SourceCharacter* but not **c**  
<sub>[+N]</sub> *SourceCharacter* but not one of **c** or **k**

*ClassAtomNoDash*<sub>[UnicodeMode, N]</sub> ::  
*SourceCharacter* but not one of \ or ] or -  
\ *ClassEscape*<sub>[?UnicodeMode, ?N]</sub>  
\ [lookahead = **c**]

*ClassEscape*<sub>[UnicodeMode, N]</sub> ::  
**b**  
<sub>[+UnicodeMode]</sub> -  
<sub>[~UnicodeMode]</sub> **c** *ClassControlLetter*  
*CharacterClassEscape*<sub>[?UnicodeMode]</sub>  
*CharacterEscape*<sub>[?UnicodeMode, ?N]</sub>

*ClassControlLetter* ::  
*DecimalDigit*  
-

NOTE When the same left-hand sides occurs with both [+UnicodeMode] and [~UnicodeMode] guards it is to control the disambiguation priority.

### B.1.2.1 Static Semantics: Early Errors

The semantics of 22.2.1.1 is extended as follows:

*ExtendedAtom* :: *InvalidBracedQuantifier*

- It is a Syntax Error if any source text is matched by this production.

Additionally, the rules for the following productions are modified with the addition of the highlighted text:

*NonemptyClassRanges* :: *ClassAtom* - *ClassAtom* *ClassRanges*

- It is a Syntax Error if *IsCharacterClass* of the first *ClassAtom* is **true** or *IsCharacterClass* of the second *ClassAtom* is **true** and this production has a [UnicodeMode] parameter.
- It is a Syntax Error if *IsCharacterClass* of the first *ClassAtom* is **false**, *IsCharacterClass* of the second *ClassAtom* is **false**, and the *CharacterValue* of the first *ClassAtom* is strictly greater than the *CharacterValue* of the second *ClassAtom*.

*NonemptyClassRangesNoDash* :: *ClassAtomNoDash* - *ClassAtom* *ClassRanges*

- It is a Syntax Error if *IsCharacterClass* of *ClassAtomNoDash* is **true** or *IsCharacterClass* of *ClassAtom* is **true** and this production has a [UnicodeMode] parameter.



- It is a Syntax Error if `IsCharacterClass` of `ClassAtomNoDash` is **false**, `IsCharacterClass` of `ClassAtom` is **false**, and the `CharacterValue` of `ClassAtomNoDash` is strictly greater than the `CharacterValue` of `ClassAtom`.

### B.1.2.2 Static Semantics: `CountLeftCapturingParensWithin` and `CountLeftCapturingParensBefore`

In the definitions of `CountLeftCapturingParensWithin` and `CountLeftCapturingParensBefore`, references to “`Atom :: ( GroupSpecifieropt Disjunction )`” are to be interpreted as meaning “`Atom :: ( GroupSpecifieropt Disjunction )`” or “`ExtendedAtom :: ( GroupSpecifieropt Disjunction )`”.

### B.1.2.3 Static Semantics: `IsCharacterClass`

The semantics of 22.2.1.5 is extended as follows:

`ClassAtomNoDash` :: \ [lookahead = **c**]

1. Return **false**.

### B.1.2.4 Static Semantics: `CharacterValue`

The semantics of 22.2.1.6 is extended as follows:

`ClassAtomNoDash` :: \ [lookahead = **c**]

1. Return the numeric value of U+005C (REVERSE SOLIDUS).

`ClassEscape` :: **c** `ClassControlLetter`

1. Let `ch` be the code point matched by `ClassControlLetter`.
2. Let `i` be the numeric value of `ch`.
3. Return the remainder of dividing `i` by 32.

`CharacterEscape` :: `LegacyOctalEscapeSequence`

1. Return the MV of `LegacyOctalEscapeSequence` (see 12.9.4.3).

### B.1.2.5 Runtime Semantics: `CompileSubpattern`

The semantics of `CompileSubpattern` is extended as follows:

The rule for `Term :: QuantifiableAssertion Quantifier` is the same as for `Term :: Atom Quantifier` but with `QuantifiableAssertion` substituted for `Atom`.

The rule for `Term :: ExtendedAtom Quantifier` is the same as for `Term :: Atom Quantifier` but with `ExtendedAtom` substituted for `Atom`.

The rule for `Term :: ExtendedAtom` is the same as for `Term :: Atom` but with `ExtendedAtom` substituted for `Atom`.

### B.1.2.6 Runtime Semantics: `CompileAssertion`

`CompileAssertion` rules for the `Assertion :: (?= Disjunction )` and `Assertion :: (?! Disjunction )` productions are also used for the `QuantifiableAssertion` productions, but with `QuantifiableAssertion` substituted for `Assertion`.

### B.1.2.7 Runtime Semantics: CompileAtom

`CompileAtom` rules for the *Atom* productions except for *Atom* :: *PatternCharacter* are also used for the *ExtendedAtom* productions, but with *ExtendedAtom* substituted for *Atom*. The following rules, with parameter *direction*, are also added:

*ExtendedAtom* :: \ [lookahead = **c**]

1. Let *A* be the `CharSet` containing the single character \ U+005C (REVERSE SOLIDUS).
2. Return `CharacterSetMatcher(rer, A, false, direction)`.

*ExtendedAtom* :: *ExtendedPatternCharacter*

1. Let *ch* be the character represented by *ExtendedPatternCharacter*.
2. Let *A* be a one-element `CharSet` containing the character *ch*.
3. Return `CharacterSetMatcher(rer, A, false, direction)`.

### B.1.2.8 Runtime Semantics: CompileToCharSet

The semantics of 22.2.2.9 is extended as follows:

The following two rules replace the corresponding rules of `CompileToCharSet`.

*NonemptyClassRanges* :: *ClassAtom* – *ClassAtom* *ClassRanges*

1. Let *A* be `CompileToCharSet` of the first *ClassAtom* with argument *rer*.
2. Let *B* be `CompileToCharSet` of the second *ClassAtom* with argument *rer*.
3. Let *C* be `CompileToCharSet` of *ClassRanges* with argument *rer*.
4. Let *D* be `CharacterRangeOrUnion(rer, A, B)`.
5. Return the union of *D* and *C*.

*NonemptyClassRangesNoDash* :: *ClassAtomNoDash* – *ClassAtom* *ClassRanges*

1. Let *A* be `CompileToCharSet` of *ClassAtomNoDash* with argument *rer*.
2. Let *B* be `CompileToCharSet` of *ClassAtom* with argument *rer*.
3. Let *C* be `CompileToCharSet` of *ClassRanges* with argument *rer*.
4. Let *D* be `CharacterRangeOrUnion(rer, A, B)`.
5. Return the union of *D* and *C*.

In addition, the following rules are added to `CompileToCharSet`.

*ClassEscape* :: **c** *ClassControlLetter*

1. Let *cv* be the `CharacterValue` of this *ClassEscape*.
2. Let *c* be the character whose character value is *cv*.
3. Return the `CharSet` containing the single character *c*.

*ClassAtomNoDash* :: \ [lookahead = **c**]

1. Return the `CharSet` containing the single character \ U+005C (REVERSE SOLIDUS).

**NOTE** This production can only be reached from the sequence \c within a character class where it is not followed by an acceptable control character.

### B.1.2.8.1 CharacterRangeOrUnion ( *rer*, *A*, *B* )

The abstract operation `CharacterRangeOrUnion` takes arguments *rer* (a `RegExp Record`), *A* (a `CharSet`), and *B* (a `CharSet`) and returns a `CharSet`. It performs the following steps when called:

1. If *rer*.[[Unicode]] is **false**, then
  - a. If *A* does not contain exactly one character or *B* does not contain exactly one character, then
    - i. Let *C* be the `CharSet` containing the single character – U+002D (HYPHEN-MINUS).
    - ii. Return the union of `CharSets` *A*, *B* and *C*.
2. Return `CharacterRange`(*A*, *B*).

### B.1.2.9 Static Semantics: ParsePattern ( *patternText*, *u* )

The semantics of 22.2.3.4 is extended as follows:

The abstract operation `ParsePattern` takes arguments *patternText* (a sequence of Unicode code points) and *u* (a Boolean). It performs the following steps when called:

1. If *u* is **true**, then
  - a. Let *parseResult* be `ParseText`(*patternText*, `Pattern`<sub>[+UnicodeMode, +N]</sub> ).
2. Else,
  - a. Let *parseResult* be `ParseText`(*patternText*, `Pattern`<sub>[-UnicodeMode, ~N]</sub> ).
  - b. If *parseResult* is a `Parse Node` and *parseResult* contains a `GroupName`, then
    - i. Set *parseResult* to `ParseText`(*patternText*, `Pattern`<sub>[-UnicodeMode, +N]</sub> ).
3. Return *parseResult*.

## B.2 Additional Built-in Properties

When the ECMAScript `host` is a web browser the following additional properties of the standard built-in objects are defined.

### B.2.1 Additional Properties of the Global Object

The entries in Table 91 are added to Table 6.

Table 91: Additional Well-known Intrinsic Objects

Intrinsic Name	Global Name	ECMAScript Language Association
<code>%escape%</code>	<code>escape</code>	The <code>escape</code> function (B.2.1.1)
<code>%unescape%</code>	<code>unescape</code>	The <code>unescape</code> function (B.2.1.2)

#### B.2.1.1 `escape` ( *string* )

This function is a property of the `global object`. It computes a new version of a String value in which certain code units have been replaced by a hexadecimal escape sequence.

When replacing a code unit of numeric value less than or equal to 0x00FF, a two-digit escape sequence of the form `%xx` is used. When replacing a code unit of numeric value strictly greater than 0x00FF, a four-digit escape sequence of the form `%uxxxx` is used.

It is the `%escape%` intrinsic object.

It performs the following steps when called:

1. Set *string* to ? `ToString(string)`.
2. Let *len* be the length of *string*.
3. Let *R* be the empty String.
4. Let *unescapedSet* be the string-concatenation of the ASCII word characters and `"@*+-./"`.
5. Let *k* be 0.
6. Repeat, while *k* < *len*,
  - a. Let *C* be the code unit at index *k* within *string*.
  - b. If *unescapedSet* contains *C*, then
    - i. Let *S* be *C*.
  - c. Else,
    - i. Let *n* be the numeric value of *C*.
    - ii. If *n* < 256, then
      1. Let *hex* be the String representation of *n*, formatted as an uppercase hexadecimal number.
      2. Let *S* be the string-concatenation of `"%"` and ! `StringPad(hex, 2F, "0"`, start).
    - iii. Else,
      1. Let *hex* be the String representation of *n*, formatted as an uppercase hexadecimal number.
      2. Let *S* be the string-concatenation of `"%u"` and ! `StringPad(hex, 4F, "0"`, start).
  - d. Set *R* to the string-concatenation of *R* and *S*.
  - e. Set *k* to *k* + 1.
7. Return *R*.

**NOTE** The encoding is partly based on the encoding described in RFC 1738, but the entire encoding specified in this standard is described above without regard to the contents of RFC 1738. This encoding does not reflect changes to RFC 1738 made by RFC 3986.

### B.2.1.2 unescape ( *string* )

This function is a property of the `global object`. It computes a new version of a String value in which each escape sequence of the sort that might be introduced by the `escape` function is replaced with the code unit that it represents.

It is the `%unescape%` intrinsic object.

It performs the following steps when called:

1. Set *string* to ? `ToString(string)`.
2. Let *len* be the length of *string*.
3. Let *R* be the empty String.
4. Let *k* be 0.
5. Repeat, while *k* < *len*,
  - a. Let *C* be the code unit at index *k* within *string*.
  - b. If *C* is the code unit 0x0025 (PERCENT SIGN), then
    - i. Let *hexDigits* be the empty String.
    - ii. Let *optionalAdvance* be 0.
    - iii. If *k* + 5 < *len* and the code unit at index *k* + 1 within *string* is the code unit 0x0075 (LATIN SMALL LETTER U), then

1. Set *hexDigits* to the **substring** of *string* from  $k + 2$  to  $k + 6$ .
  2. Set *optionalAdvance* to 5.
  - iv. Else if  $k + 3 \leq len$ , then
    1. Set *hexDigits* to the **substring** of *string* from  $k + 1$  to  $k + 3$ .
    2. Set *optionalAdvance* to 2.
  - v. Let *parseResult* be **ParseText**(**StringToCodePoints**(*hexDigits*), *HexDigits*<sub>[~sep]</sub> ).
  - vi. If *parseResult* is a **Parse Node**, then
    1. Let *n* be the MV of *parseResult*.
    2. Set *C* to the code unit whose numeric value is *n*.
    3. Set *k* to  $k + \text{optionalAdvance}$ .
  - c. Set *R* to the **string-concatenation** of *R* and *C*.
  - d. Set *k* to  $k + 1$ .
6. Return *R*.

## B.2.2 Additional Properties of the String.prototype Object

### B.2.2.1 String.prototype.substr ( *start*, *length* )

This method returns a substring of the result of converting the **this** value to a String, starting from index *start* and running for *length* code units (or through the end of the String if *length* is **undefined**). If *start* is negative, it is treated as  $sourceLength + start$  where *sourceLength* is the length of the String. The result is a String value, not a String object.

It performs the following steps when called:

1. Let *O* be ? **RequireObjectCoercible**(**this** value).
2. Let *S* be ? **ToString**(*O*).
3. Let *size* be the length of *S*.
4. Let *intStart* be ? **ToIntegerOrInfinity**(*start*).
5. If *intStart* =  $-\infty$ , set *intStart* to 0.
6. Else if *intStart* < 0, set *intStart* to  $\max(\text{size} + \text{intStart}, 0)$ .
7. Else, set *intStart* to  $\min(\text{intStart}, \text{size})$ .
8. If *length* is **undefined**, let *intLength* be *size*; otherwise let *intLength* be ? **ToIntegerOrInfinity**(*length*).
9. Set *intLength* to the result of **clamping** *intLength* between 0 and *size*.
10. Let *intEnd* be  $\min(\text{intStart} + \text{intLength}, \text{size})$ .
11. Return the **substring** of *S* from *intStart* to *intEnd*.

**NOTE** This method is intentionally generic; it does not require that its **this** value be a String object. Therefore it can be transferred to other kinds of objects for use as a method.

### B.2.2.2 String.prototype.anchor ( *name* )

This method performs the following steps when called:

1. Let *S* be the **this** value.
2. Return ? **CreateHTML**(*S*, "a", "name", *name*).

#### B.2.2.2.1 CreateHTML ( *string*, *tag*, *attribute*, *value* )

The abstract operation **CreateHTML** takes arguments *string* (an ECMAScript language value), *tag* (a String), *attribute* (a String), and *value* (an ECMAScript language value) and returns either a normal completion

containing a String or a [throw completion](#). It performs the following steps when called:

1. Let *str* be ? [RequireObjectCoercible](#)(*string*).
2. Let *S* be ? [ToString](#)(*str*).
3. Let *p1* be the [string-concatenation](#) of "<" and *tag*.
4. If *attribute* is not the empty String, then
  - a. Let *V* be ? [ToString](#)(*value*).
  - b. Let *escapedV* be the String value that is the same as *V* except that each occurrence of the code unit 0x0022 (QUOTATION MARK) in *V* has been replaced with the six code unit sequence "&quot;".
  - c. Set *p1* to the [string-concatenation](#) of:
    - *p1*
    - the code unit 0x0020 (SPACE)
    - *attribute*
    - the code unit 0x003D (EQUALS SIGN)
    - the code unit 0x0022 (QUOTATION MARK)
    - *escapedV*
    - the code unit 0x0022 (QUOTATION MARK)
5. Let *p2* be the [string-concatenation](#) of *p1* and ">".
6. Let *p3* be the [string-concatenation](#) of *p2* and *S*.
7. Let *p4* be the [string-concatenation](#) of *p3*, "</", *tag*, and ">".
8. Return *p4*.

### B.2.2.3 String.prototype.big ( )

This method performs the following steps when called:

1. Let *S* be the **this** value.
2. Return ? [CreateHTML](#)(*S*, "big", "", "").

### B.2.2.4 String.prototype.blink ( )

This method performs the following steps when called:

1. Let *S* be the **this** value.
2. Return ? [CreateHTML](#)(*S*, "blink", "", "").

### B.2.2.5 String.prototype.bold ( )

This method performs the following steps when called:

1. Let *S* be the **this** value.
2. Return ? [CreateHTML](#)(*S*, "b", "", "").

### B.2.2.6 String.prototype.fixed ( )

This method performs the following steps when called:

1. Let *S* be the **this** value.
2. Return ? [CreateHTML](#)(*S*, "tt", "", "").

### **B.2.2.7 String.prototype.fontcolor ( *color* )**

This method performs the following steps when called:

1. Let *S* be the **this** value.
2. Return ? [CreateHTML](#)(*S*, "font", "color", *color*).

### **B.2.2.8 String.prototype.fontSize ( *size* )**

This method performs the following steps when called:

1. Let *S* be the **this** value.
2. Return ? [CreateHTML](#)(*S*, "font", "size", *size*).

### **B.2.2.9 String.prototype.italics ( )**

This method performs the following steps when called:

1. Let *S* be the **this** value.
2. Return ? [CreateHTML](#)(*S*, "i", "", "").

### **B.2.2.10 String.prototype.link ( *url* )**

This method performs the following steps when called:

1. Let *S* be the **this** value.
2. Return ? [CreateHTML](#)(*S*, "a", "href", *url*).

### **B.2.2.11 String.prototype.small ( )**

This method performs the following steps when called:

1. Let *S* be the **this** value.
2. Return ? [CreateHTML](#)(*S*, "small", "", "").

### **B.2.2.12 String.prototype.strike ( )**

This method performs the following steps when called:

1. Let *S* be the **this** value.
2. Return ? [CreateHTML](#)(*S*, "strike", "", "").

### **B.2.2.13 String.prototype.sub ( )**

This method performs the following steps when called:

1. Let *S* be the **this** value.
2. Return ? [CreateHTML](#)(*S*, "sub", "", "").

### B.2.2.14 String.prototype.sup ( )

This method performs the following steps when called:

1. Let *S* be the **this** value.
2. Return ? [CreateHTML](#)(*S*, "sup", "", "").

### B.2.2.15 String.prototype.trimLeft ( )

**NOTE** The property **"trimStart"** is preferred. The **"trimLeft"** property is provided principally for compatibility with old code. It is recommended that the **"trimStart"** property be used in new ECMAScript code.

The initial value of the **"trimLeft"** property is %String.prototype.trimStart%, defined in [22.1.3.32](#).

### B.2.2.16 String.prototype.trimRight ( )

**NOTE** The property **"trimEnd"** is preferred. The **"trimRight"** property is provided principally for compatibility with old code. It is recommended that the **"trimEnd"** property be used in new ECMAScript code.

The initial value of the **"trimRight"** property is %String.prototype.trimEnd%, defined in [22.1.3.31](#).

## B.2.3 Additional Properties of the Date.prototype Object

### B.2.3.1 Date.prototype.getYear ( )

**NOTE** The **getFullYear** method is preferred for nearly all purposes, because it avoids the “year 2000 problem.”

This method performs the following steps when called:

1. Let *t* be ? [thisTimeValue](#)(**this** value).
2. If *t* is **NaN**, return **NaN**.
3. Return [YearFromTime](#)([LocalTime](#)(*t*)) - 1900<sub>F</sub>.

### B.2.3.2 Date.prototype.setYear ( *year* )

**NOTE** The **setFullYear** method is preferred for nearly all purposes, because it avoids the “year 2000 problem.”

This method performs the following steps when called:

1. Let *t* be ? [thisTimeValue](#)(**this** value).
2. Let *y* be ? [ToNumber](#)(*year*).
3. If *t* is **NaN**, set *t* to +0<sub>F</sub>; otherwise, set *t* to [LocalTime](#)(*t*).
4. If *y* is **NaN**, then



- a. Set the `[[DateValue]]` internal slot of *this Date object* to **NaN**.
- b. Return **NaN**.
5. Let *yi* be `! ToIntegerOrInfinity(y)`.
6. If  $0 \leq yi \leq 99$ , let *yyyy* be  $1900_F + F(yi)$ .
7. Else, let *yyyy* be *y*.
8. Let *d* be `MakeDay(yyyy, MonthFromTime(t), DateFromTime(t))`.
9. Let *date* be `UTC(MakeDate(d, TimeWithinDay(t)))`.
10. Set the `[[DateValue]]` internal slot of *this Date object* to `TimeClip(date)`.
11. Return the value of the `[[DateValue]]` internal slot of *this Date object*.

### B.2.3.3 Date.prototype.toGMTString ( )

**NOTE** The `toUTCString` method is preferred. This method is provided principally for compatibility with old code.

The initial value of the `"toGMTString"` property is `%Date.prototype.toUTCString%`, defined in 21.4.4.43.

## B.2.4 Additional Properties of the RegExp.prototype Object

### B.2.4.1 RegExp.prototype.compile ( *pattern*, *flags* )

This method performs the following steps when called:

1. Let *O* be the **this** value.
2. Perform `? RequireInternalSlot(O, [[RegExpMatcher]])`.
3. If *pattern* is an Object and *pattern* has a `[[RegExpMatcher]]` internal slot, then
  - a. If *flags* is not **undefined**, throw a **TypeError** exception.
  - b. Let *P* be *pattern*.`[[OriginalSource]]`.
  - c. Let *F* be *pattern*.`[[OriginalFlags]]`.
4. Else,
  - a. Let *P* be *pattern*.
  - b. Let *F* be *flags*.
5. Return `? RegExpInitialize(O, P, F)`.

**NOTE** This method completely reinitializes the **this** value RegExp with a new pattern and flags. An implementation may interpret use of this method as an assertion that the resulting RegExp object will be used multiple times and hence is a candidate for extra optimization.

## B.3 Other Additional Features

### B.3.1 Labelled Function Declarations

Prior to ECMAScript 2015, the specification of *LabelledStatement* did not allow for the association of a statement label with a *FunctionDeclaration*. However, a labelled *FunctionDeclaration* was an allowable extension for *non-strict code* and most browser-hosted ECMAScript implementations supported that extension. In ECMAScript 2015 and later, the grammar production for *LabelledStatement* permits use of *FunctionDeclaration* as a *LabelledItem* but 14.13.1 includes an Early Error rule that produces a Syntax Error if that occurs. That rule is modified with the addition of the highlighted text:

LabelledItem : *FunctionDeclaration*

- It is a Syntax Error if any source text [that is strict mode code](#) is matched by this production.

NOTE The [early error](#) rules for *WithStatement*, *IfStatement*, and *IterationStatement* prevent these statements from containing a labelled *FunctionDeclaration* in [non-strict code](#).

### B.3.2 Block-Level Function Declarations Web Legacy Compatibility Semantics

Prior to ECMAScript 2015, the ECMAScript specification did not define the occurrence of a *FunctionDeclaration* as an element of a *Block* statement's *StatementList*. However, support for that form of *FunctionDeclaration* was an allowable extension and most browser-hosted ECMAScript implementations permitted them. Unfortunately, the semantics of such declarations differ among those implementations. Because of these semantic differences, existing web [ECMAScript source text](#) that uses *Block* level function declarations is only portable among browser implementations if the usage only depends upon the semantic intersection of all of the browser implementations for such declarations. The following are the use cases that fall within that intersection semantics:

1. A function is declared and only referenced within a single block.
  - One or more *FunctionDeclarations* whose *BindingIdentifier* is the name *f* occur within the function code of an enclosing function *g* and that declaration is nested within a *Block*.
  - No other declaration of *f* that is not a **var** declaration occurs within the function code of *g*.
  - All occurrences of *f* as an *IdentifierReference* are within the *StatementList* of the *Block* containing the declaration of *f*.
2. A function is declared and possibly used within a single *Block* but also referenced by an inner function definition that is not contained within that same *Block*.
  - One or more *FunctionDeclarations* whose *BindingIdentifier* is the name *f* occur within the function code of an enclosing function *g* and that declaration is nested within a *Block*.
  - No other declaration of *f* that is not a **var** declaration occurs within the function code of *g*.
  - There may be occurrences of *f* as an *IdentifierReference* within the *StatementList* of the *Block* containing the declaration of *f*.
  - There is at least one occurrence of *f* as an *IdentifierReference* within another function *h* that is nested within *g* and no other declaration of *f* shadows the references to *f* from within *h*.
  - All invocations of *h* occur after the declaration of *f* has been evaluated.
3. A function is declared and possibly used within a single block but also referenced within subsequent blocks.
  - One or more *FunctionDeclaration* whose *BindingIdentifier* is the name *f* occur within the function code of an enclosing function *g* and that declaration is nested within a *Block*.
  - No other declaration of *f* that is not a **var** declaration occurs within the function code of *g*.
  - There may be occurrences of *f* as an *IdentifierReference* within the *StatementList* of the *Block* containing the declaration of *f*.
  - There is at least one occurrence of *f* as an *IdentifierReference* within the function code of *g* that lexically follows the *Block* containing the declaration of *f*.

The first use case is interoperable with the semantics of *Block* level function declarations provided by ECMAScript 2015. Any pre-existing [ECMAScript source text](#) that employs that use case will operate using the *Block* level function declarations semantics defined by clauses 10, 14, and 15.

ECMAScript 2015 interoperability for the second and third use cases requires the following extensions to the clause 10, clause 15, clause 19.2.1 and clause 16.1.7 semantics.

If an ECMAScript implementation has a mechanism for reporting diagnostic warning messages, a warning should be produced when code contains a *FunctionDeclaration* for which these compatibility semantics are applied and introduce observable differences from non-compatibility semantics. For example, if a **var** binding

is not introduced because its introduction would create an **early error**, a warning message should not be produced.

### B.3.2.1 Changes to FunctionDeclarationInstantiation

During **FunctionDeclarationInstantiation** the following steps are performed in place of step 29:

29. If *strict* is **false**, then
  - a. For each *FunctionDeclaration* *f* that is directly contained in the *StatementList* of a *Block*, *CaseClause*, or *DefaultClause*, do
    - i. Let *F* be **StringValue** of the *BindingIdentifier* of *f*.
    - ii. If replacing the *FunctionDeclaration* *f* with a *VariableStatement* that has *F* as a *BindingIdentifier* would not produce any Early Errors for *func* and *parameterNames* does not contain *F*, then
      1. NOTE: A var binding for *F* is only instantiated here if it is neither a *VarDeclaredName*, the name of a formal parameter, or another *FunctionDeclaration*.
      2. If *initializedBindings* does not contain *F* and *F* is not **"arguments"**, then
        - a. Perform ! *varEnv*.CreateMutableBinding(*F*, **false**).
        - b. Perform ! *varEnv*.InitializeBinding(*F*, **undefined**).
        - c. Append *F* to *instantiatedVarNames*.
      3. When the *FunctionDeclaration* *f* is evaluated, perform the following steps in place of the *FunctionDeclaration Evaluation* algorithm provided in 15.2.6:
        - a. Let *fenv* be the *running execution context*'s *VariableEnvironment*.
        - b. Let *benv* be the *running execution context*'s *LexicalEnvironment*.
        - c. Let *fobj* be ! *benv*.GetBindingValue(*F*, **false**).
        - d. Perform ! *fenv*.SetMutableBinding(*F*, *fobj*, **false**).
        - e. Return unused.

### B.3.2.2 Changes to GlobalDeclarationInstantiation

During **GlobalDeclarationInstantiation** the following steps are performed in place of step 12:

12. Perform the following steps:
  - a. Let *strict* be **IsStrict** of *script*.
  - b. If *strict* is **false**, then
    - i. Let *declaredFunctionOrVarNames* be the *list-concatenation* of *declaredFunctionNames* and *declaredVarNames*.
    - ii. For each *FunctionDeclaration* *f* that is directly contained in the *StatementList* of a *Block*, *CaseClause*, or *DefaultClause* Contained within *script*, do
      1. Let *F* be **StringValue** of the *BindingIdentifier* of *f*.
      2. If replacing the *FunctionDeclaration* *f* with a *VariableStatement* that has *F* as a *BindingIdentifier* would not produce any Early Errors for *script*, then
        - a. If *env*.HasLexicalDeclaration(*F*) is **false**, then
          - i. Let *fnDefinable* be ? *env*.CanDeclareGlobalVar(*F*).
          - ii. If *fnDefinable* is **true**, then
            - i. NOTE: A var binding for *F* is only instantiated here if it is neither a *VarDeclaredName* nor the name of another *FunctionDeclaration*.
            - ii. If *declaredFunctionOrVarNames* does not contain *F*, then
              - i. Perform ? *env*.CreateGlobalVarBinding(*F*, **false**).
              - ii. Append *F* to *declaredFunctionOrVarNames*.

- iii. When the *FunctionDeclaration* *f* is evaluated, perform the following steps in place of the *FunctionDeclaration Evaluation* algorithm provided in 15.2.6:
  - i. Let *genv* be the *running execution context*'s *VariableEnvironment*.
  - ii. Let *benv* be the *running execution context*'s *LexicalEnvironment*.
  - iii. Let *fobj* be ! *benv*.GetBindingValue(*F*, **false**).
  - iv. Perform ? *genv*.SetMutableBinding(*F*, *fobj*, **false**).
  - v. Return unused.

### B.3.2.3 Changes to EvalDeclarationInstantiation

During *EvalDeclarationInstantiation* the following steps are performed in place of step 11:

- 11. If *strict* is **false**, then
  - a. Let *declaredFunctionOrVarNames* be the *list-concatenation* of *declaredFunctionNames* and *declaredVarNames*.
  - b. For each *FunctionDeclaration* *f* that is directly contained in the *StatementList* of a *Block*, *CaseClause*, or *DefaultClause* Contained within *body*, do
    - i. Let *F* be *StringValue* of the *BindingIdentifier* of *f*.
    - ii. If replacing the *FunctionDeclaration* *f* with a *VariableStatement* that has *F* as a *BindingIdentifier* would not produce any Early Errors for *body*, then
      - 1. Let *bindingExists* be **false**.
      - 2. Let *thisEnv* be *lexEnv*.
      - 3. **Assert**: The following loop will terminate.
      - 4. Repeat, while *thisEnv* is not *varEnv*,
        - a. If *thisEnv* is not an *Object Environment Record*, then
          - i. If ! *thisEnv*.HasBinding(*F*) is **true**, then
            - i. Let *bindingExists* be **true**.
          - b. Set *thisEnv* to *thisEnv*.[[OuterEnv]].
        - 5. If *bindingExists* is **false** and *varEnv* is a *Global Environment Record*, then
          - a. If *varEnv*.HasLexicalDeclaration(*F*) is **false**, then
            - i. Let *fnDefinable* be ? *varEnv*.CanDeclareGlobalVar(*F*).
          - b. Else,
            - i. Let *fnDefinable* be **false**.
        - 6. Else,
          - a. Let *fnDefinable* be **true**.
        - 7. If *bindingExists* is **false** and *fnDefinable* is **true**, then
          - a. If *declaredFunctionOrVarNames* does not contain *F*, then
            - i. If *varEnv* is a *Global Environment Record*, then
              - i. Perform ? *varEnv*.CreateGlobalVarBinding(*F*, **true**).
            - ii. Else,
              - i. Let *bindingExists* be ! *varEnv*.HasBinding(*F*).
              - ii. If *bindingExists* is **false**, then
                - i. Perform ! *varEnv*.CreateMutableBinding(*F*, **true**).
                - ii. Perform ! *varEnv*.InitializeBinding(*F*, **undefined**).
            - iii. Append *F* to *declaredFunctionOrVarNames*.
- b. When the *FunctionDeclaration* *f* is evaluated, perform the following steps in place of the *FunctionDeclaration Evaluation* algorithm provided in 15.2.6:
  - i. Let *genv* be the *running execution context*'s *VariableEnvironment*.

- ii. Let *benv* be the **running execution context**'s `LexicalEnvironment`.
- iii. Let *fobj* be `! benv.GetBindingValue(F, false)`.
- iv. Perform `? genv.SetMutableBinding(F, fobj, false)`.
- v. Return unused.

### B.3.2.4 Changes to Block Static Semantics: Early Errors

The rules for the following production in 14.2.1 are modified with the addition of the **highlighted** text:

*Block* : { *StatementList* }

- It is a Syntax Error if the `LexicallyDeclaredNames` of *StatementList* contains any duplicate entries, **unless the source text matched by this production is not strict mode code and the duplicate entries are only bound by FunctionDeclarations.**
- It is a Syntax Error if any element of the `LexicallyDeclaredNames` of *StatementList* also occurs in the `VarDeclaredNames` of *StatementList*.

### B.3.2.5 Changes to switch Statement Static Semantics: Early Errors

The rules for the following production in 14.12.1 are modified with the addition of the **highlighted** text:

*SwitchStatement* : **switch** ( *Expression* ) *CaseBlock*

- It is a Syntax Error if the `LexicallyDeclaredNames` of *CaseBlock* contains any duplicate entries, **unless the source text matched by this production is not strict mode code and the duplicate entries are only bound by FunctionDeclarations.**
- It is a Syntax Error if any element of the `LexicallyDeclaredNames` of *CaseBlock* also occurs in the `VarDeclaredNames` of *CaseBlock*.

### B.3.2.6 Changes to BlockDeclarationInstantiation

During `BlockDeclarationInstantiation` the following steps are performed in place of step 3.a.ii.1:

1. If `! env.HasBinding(dn)` is **false**, then
  - a. Perform `! env.CreateMutableBinding(dn, false)`.

During `BlockDeclarationInstantiation` the following steps are performed in place of step 3.b.iii:

- iii. Perform the following steps:
  1. If the binding for *fn* in *env* is an uninitialized binding, then
    - a. Perform `! env.InitializeBinding(fn, fo)`.
  2. Else,
    - a. **Assert:** *d* is a *FunctionDeclaration*.
    - b. Perform `! env.SetMutableBinding(fn, fo, false)`.

### B.3.3 FunctionDeclarations in IfStatement Statement Clauses

The following augments the *IfStatement* production in 14.6:

```
IfStatement[Yield, Await, Return] :
  if ( Expression[+In, ?Yield, ?Await] )
    FunctionDeclaration[?Yield, ?Await, ~Default] else
    Statement[?Yield, ?Await, ?Return]
```

```

if ( Expression[+In, ?Yield, ?Await] ) Statement[?Yield, ?Await, ?Return] else
  FunctionDeclaration[?Yield, ?Await, ~Default]
if ( Expression[+In, ?Yield, ?Await] )
  FunctionDeclaration[?Yield, ?Await, ~Default] else
  FunctionDeclaration[?Yield, ?Await, ~Default]
if ( Expression[+In, ?Yield, ?Await] )
  FunctionDeclaration[?Yield, ?Await, ~Default] [lookahead ≠ else]

```

This production only applies when parsing [non-strict code](#). Source text matched by this production is processed as if each matching occurrence of *FunctionDeclaration*<sub>[?Yield, ?Await, ~Default]</sub> was the sole *StatementListItem* of a *BlockStatement* occupying that position in the source text. The semantics of such a synthetic *BlockStatement* includes the web legacy compatibility semantics specified in [B.3.2](#).

### B.3.4 VariableStatements in Catch Blocks

The content of subclause [14.15.1](#) is replaced with the following:

*Catch* : **catch** ( *CatchParameter* ) *Block*

- It is a Syntax Error if [BoundNames](#) of *CatchParameter* contains any duplicate elements.
- It is a Syntax Error if any element of the [BoundNames](#) of *CatchParameter* also occurs in the [LexicallyDeclaredNames](#) of *Block*.
- It is a Syntax Error if any element of the [BoundNames](#) of *CatchParameter* also occurs in the [VarDeclaredNames](#) of *Block* unless *CatchParameter* is *CatchParameter* : *BindingIdentifier* .

**NOTE** The *Block* of a *Catch* clause may contain **var** declarations that bind a name that is also bound by the *CatchParameter*. At runtime, such bindings are instantiated in the *VariableDeclarationEnvironment*. They do not shadow the same-named bindings introduced by the *CatchParameter* and hence the *Initializer* for such **var** declarations will assign to the corresponding catch parameter rather than the **var** binding.

This modified behaviour also applies to **var** and **function** declarations introduced by [direct eval](#) calls contained within the *Block* of a *Catch* clause. This change is accomplished by modifying the algorithm of [19.2.1.3](#) as follows:

Step [3.d.i.2.a.i](#) is replaced by:

- i. If *thisEnv* is not the [Environment Record](#) for a *Catch* clause, throw a **SyntaxError** exception.

Step [11.b.ii.4.a.i.i](#) is replaced by:

- i. If *thisEnv* is not the [Environment Record](#) for a *Catch* clause, let *bindingExists* be **true**.

### B.3.5 Initializers in ForIn Statement Heads

The following augments the *ForInOfStatement* production in [14.7.5](#):

```

ForInOfStatement[Yield, Await, Return] :
  for ( var BindingIdentifier[?Yield, ?Await] Initializer[~In, ?Yield, ?Await] in
    Expression[+In, ?Yield, ?Await] ) Statement[?Yield, ?Await, ?Return]

```

This production only applies when parsing [non-strict code](#).

The [static semantics](#) of [ContainsDuplicateLabels](#) in [8.3.1](#) are augmented with the following:

*ForInOfStatement* : **for** ( **var** *BindingIdentifier Initializer* **in** *Expression* ) *Statement*

1. Return *ContainsDuplicateLabels* of *Statement* with argument *labelSet*.

The static semantics of *ContainsUndefinedBreakTarget* in 8.3.2 are augmented with the following:

*ForInOfStatement* : **for** ( **var** *BindingIdentifier Initializer* **in** *Expression* ) *Statement*

1. Return *ContainsUndefinedBreakTarget* of *Statement* with argument *labelSet*.

The static semantics of *ContainsUndefinedContinueTarget* in 8.3.3 are augmented with the following:

*ForInOfStatement* : **for** ( **var** *BindingIdentifier Initializer* **in** *Expression* ) *Statement*

1. Return *ContainsUndefinedContinueTarget* of *Statement* with arguments *iterationSet* and « ».

The static semantics of *IsDestructuring* in 14.7.5.2 are augmented with the following:

*BindingIdentifier* :  
*Identifier*  
**yield**  
**await**

1. Return **false**.

The static semantics of *VarDeclaredNames* in 8.2.6 are augmented with the following:

*ForInOfStatement* : **for** ( **var** *BindingIdentifier Initializer* **in** *Expression* ) *Statement*

1. Let *names1* be the *BoundNames* of *BindingIdentifier*.
2. Let *names2* be the *VarDeclaredNames* of *Statement*.
3. Return the list-concatenation of *names1* and *names2*.

The static semantics of *VarScopedDeclarations* in 8.2.7 are augmented with the following:

*ForInOfStatement* : **for** ( **var** *BindingIdentifier Initializer* **in** *Expression* ) *Statement*

1. Let *declarations1* be « *BindingIdentifier* ».
2. Let *declarations2* be the *VarScopedDeclarations* of *Statement*.
3. Return the list-concatenation of *declarations1* and *declarations2*.

The runtime semantics of *ForInOfLoopEvaluation* in 14.7.5.5 are augmented with the following:

*ForInOfStatement* : **for** ( **var** *BindingIdentifier Initializer* **in** *Expression* ) *Statement*

1. Let *bindingId* be *StringValue* of *BindingIdentifier*.
2. Let *lhs* be ? *ResolveBinding*(*bindingId*).
3. If *IsAnonymousFunctionDefinition*(*Initializer*) is **true**, then
  - a. Let *value* be ? *NamedEvaluation* of *Initializer* with argument *bindingId*.
4. Else,
  - a. Let *rhs* be ? *Evaluation* of *Initializer*.
  - b. Let *value* be ? *GetValue*(*rhs*).
5. Perform ? *PutValue*(*lhs*, *value*).
6. Let *keyResult* be ? *ForIn/OfHeadEvaluation*(« », *Expression*, enumerate).
7. Return ? *ForIn/OfBodyEvaluation*(*BindingIdentifier*, *Statement*, *keyResult*, enumerate, *varBinding*, *labelSet*).

### B.3.6 The `[[IsHTMLDDA]]` Internal Slot

An `[[IsHTMLDDA]]` *internal slot* may exist on `host-defined` objects. Objects with an `[[IsHTMLDDA]]` internal slot behave like `undefined` in the `ToBoolean` and `IsLooselyEqual` abstract operations and when used as an operand for the `typeof` operator.

**NOTE** Objects with an `[[IsHTMLDDA]]` internal slot are never created by this specification. However, the `document.all` object in web browsers is a `host-defined exotic object` with this slot that exists for web compatibility purposes. There are no other known examples of this type of object and implementations should not create any with the exception of `document.all`.

#### B.3.6.1 Changes to `ToBoolean`

The following step replaces step 3 of `ToBoolean`:

3. If *argument* is an `Object` and *argument* has an `[[IsHTMLDDA]]` internal slot, return `false`.

#### B.3.6.2 Changes to `IsLooselyEqual`

The following steps replace step 4 of `IsLooselyEqual`:

4. Perform the following steps:
  - a. If *x* is an `Object`, *x* has an `[[IsHTMLDDA]]` internal slot, and *y* is either `null` or `undefined`, return `true`.
  - b. If *x* is either `null` or `undefined`, *y* is an `Object`, and *y* has an `[[IsHTMLDDA]]` internal slot, return `true`.

#### B.3.6.3 Changes to the `typeof` Operator

The following step replaces step 12 of the evaluation semantics for `typeof`:

12. If *val* has an `[[IsHTMLDDA]]` internal slot, return `"undefined"`.

### B.3.7 Non-default behaviour in `HostMakeJobCallback`

The `HostMakeJobCallback` abstract operation allows `hosts` which are web browsers to specify non-default behaviour.

### B.3.8 Non-default behaviour in `HostEnsureCanAddPrivateElement`

The `HostEnsureCanAddPrivateElement` abstract operation allows `hosts` which are web browsers to specify non-default behaviour.



## C The Strict Mode of ECMAScript

### Annex C

(informative)

## The Strict Mode of ECMAScript

### The strict mode restriction and exceptions

- **implements**, **interface**, **let**, **package**, **private**, **protected**, **public**, **static**, and **yield** are **reserved words** within **strict mode code**. (12.7.2).
- A conforming implementation, when processing **strict mode code**, must disallow instances of the productions *NumericLiteral* :: *LegacyOctalIntegerLiteral* and *DecimalIntegerLiteral* :: *NonOctalDecimalIntegerLiteral* .
- A conforming implementation, when processing **strict mode code**, must disallow instances of the productions *EscapeSequence* :: *LegacyOctalEscapeSequence* and *EscapeSequence* :: *NonOctalDecimalEscapeSequence* .
- Assignment to an undeclared identifier or otherwise unresolvable reference does not create a property in the **global object**. When a simple assignment occurs within **strict mode code**, its *LeftHandSideExpression* must not evaluate to an unresolvable Reference. If it does a **ReferenceError** exception is thrown (6.2.5.6). The *LeftHandSideExpression* also may not be a reference to a **data property** with the attribute value { **[[Writable]]**: **false** }, to an **accessor property** with the attribute value { **[[Set]]**: **undefined** }, nor to a non-existent property of an object whose **[[Extensible]]** internal slot is **false**. In these cases a **TypeError** exception is thrown (13.15).
- An *IdentifierReference* with the **StringValue** **"eval"** or **"arguments"** may not appear as the *LeftHandSideExpression* of an Assignment operator (13.15) or of an *UpdateExpression* (13.4) or as the *UnaryExpression* operated upon by a Prefix Increment (13.4.4) or a Prefix Decrement (13.4.5) operator.
- Arguments objects for **strict functions** define a non-configurable **accessor property** **"callee"** which throws a **TypeError** exception on access (10.4.4.6).
- Arguments objects for **strict functions** do not dynamically share their **array-indexed** property values with the corresponding formal parameter bindings of their functions. (10.4.4).
- For **strict functions**, if an arguments object is created the binding of the local identifier **arguments** to the arguments object is immutable and hence may not be the target of an assignment expression. (10.2.11).
- It is a **SyntaxError** if the **StringValue** of a *BindingIdentifier* is either **"eval"** or **"arguments"** within **strict mode code** (13.1.1).
- Strict mode eval code cannot instantiate variables or functions in the variable environment of the caller to eval. Instead, a new variable environment is created and that environment is used for declaration binding instantiation for the eval code (19.2.1).
- If **this** is evaluated within **strict mode code**, then the **this** value is not coerced to an object. A **this** value of either **undefined** or **null** is not converted to the **global object** and primitive values are not converted to wrapper objects. The **this** value passed via a function call (including calls made using **Function.prototype.apply** and **Function.prototype.call**) do not coerce the passed **this** value to an object (10.2.1.2, 20.2.3.1, 20.2.3.3).
- When a **delete** operator occurs within **strict mode code**, a **SyntaxError** is thrown if its *UnaryExpression* is a direct reference to a variable, function argument, or function name (13.5.1.1).
- When a **delete** operator occurs within **strict mode code**, a **TypeError** is thrown if the property to be deleted has the attribute { **[[Configurable]]**: **false** } or otherwise cannot be deleted (13.5.1.2).
- **Strict mode code** may not include a *WithStatement*. The occurrence of a *WithStatement* in such a context is a **SyntaxError** (14.11.1).
- It is a **SyntaxError** if a *CatchParameter* occurs within **strict mode code** and **BoundNames** of *CatchParameter* contains either **eval** or **arguments** (14.15.1).
- It is a **SyntaxError** if the same *BindingIdentifier* appears more than once in the *FormalParameters* of a **strict function**. An attempt to create such a function using a Function, Generator, or AsyncFunction

- `constructor` is a **SyntaxError** (15.2.1, 20.2.1.1.1).
- An implementation may not extend, beyond that defined in this specification, the meanings within `strict functions` of properties named **"caller"** or **"arguments"** of function instances.

## Annex D

(informative)

### Host Layering Points

See 4.2 for the definition of [host](#).

#### D.1 Host Hooks

[HostCallJobCallback\(...\)](#)

[HostEnqueueFinalizationRegistryCleanupJob\(...\)](#)

[HostEnqueuePromiseJob\(...\)](#)

[HostEnsureCanCompileStrings\(...\)](#)

[HostFinalizeImportMeta\(...\)](#)

[HostGetImportMetaProperties\(...\)](#)

[HostHasSourceTextAvailable\(...\)](#)

[HostLoadImportedModule\(...\)](#)

[HostMakeJobCallback\(...\)](#)

[HostPromiseRejectionTracker\(...\)](#)

[InitializeHostDefinedRealm\(...\)](#)

#### D.2 Host-defined Fields

[\[\[HostDefined\]\]](#) on [Realm Records](#): See [Table 24](#).

[\[\[HostDefined\]\]](#) on [Script Records](#): See [Table 39](#).

[\[\[HostDefined\]\]](#) on [Module Records](#): See [Table 40](#).

[\[\[HostDefined\]\]](#) on [JobCallback Records](#): See [Table 28](#).

[\[\[HostSynchronizesWith\]\]](#) on [Candidate Executions](#): See [Table 90](#).

[\[\[IsHTMLDDA\]\]](#): See [B.3.6](#).

### **D.3 Host-defined Objects**

The [global object](#): See clause [19](#).

### **D.4 Running Jobs**

Preparation steps before, and cleanup steps after, invocation of [Job Abstract Closures](#). See [9.5](#).

### **D.5 Internal Methods of Exotic Objects**

Any of the essential internal methods in [Table 4](#) for any [exotic object](#) not specified within this specification.

### **D.6 Built-in Objects and Methods**

Any built-in objects and methods not defined within this specification, except as restricted in [17.1](#).

## Annex E

(informative)

### Corrections and Clarifications in ECMAScript 2015 with Possible Compatibility Impact

9.1.1.4.15-9.1.1.4.18 Edition 5 and 5.1 used a property existence test to determine whether a [global object](#) property corresponding to a new global declaration already existed. ECMAScript 2015 uses an own property existence test. This corresponds to what has been most commonly implemented by web browsers.

10.4.2.1: The 5<sup>th</sup> Edition moved the capture of the current array length prior to the [integer](#) conversion of the [array index](#) or new length value. However, the captured length value could become invalid if the conversion process has the side-effect of changing the array length. ECMAScript 2015 specifies that the current array length must be captured after the possible occurrence of such side-effects.

21.4.1.17: Previous editions permitted the [TimeClip](#) abstract operation to return either  $+0_F$  or  $-0_F$  as the representation of a 0 [time value](#). ECMAScript 2015 specifies that  $+0_F$  always returned. This means that for ECMAScript 2015 the [time value](#) of a Date is never observably  $-0_F$  and methods that return [time values](#) never return  $-0_F$ .

21.4.1.18: If a UTC offset representation is not present, the local time zone is used. Edition 5.1 incorrectly stated that a missing time zone should be interpreted as "z".

21.4.4.36: If the year cannot be represented using the Date Time String Format specified in 21.4.1.18 a RangeError exception is thrown. Previous editions did not specify the behaviour for that case.

21.4.4.41: Previous editions did not specify the value returned by [Date.prototype.toString](#) when [this time value](#) is NaN. ECMAScript 2015 specifies the result to be the String value "Invalid Date".

22.2.4.1, 22.2.6.13.1: Any LineTerminator code points in the value of the "source" property of a RegExp instance must be expressed using an escape sequence. Edition 5.1 only required the escaping of /.

22.2.6.8, 22.2.6.11: In previous editions, the specifications for [String.prototype.match](#) and [String.prototype.replace](#) was incorrect for cases where the pattern argument was a RegExp value whose [global](#) flag is set. The previous specifications stated that for each attempt to match the pattern, if [lastIndex](#) did not change, it should be incremented by 1. The correct behaviour is that [lastIndex](#) should be incremented by 1 only if the pattern matched the empty String.

23.1.3.30: Previous editions did not specify how a NaN value returned by a [comparefn](#) was interpreted by [Array.prototype.sort](#). ECMAScript 2015 specifies that such as value is treated as if  $+0_F$  was returned from the [comparefn](#). ECMAScript 2015 also specifies that [ToNumber](#) is applied to the result returned by a [comparefn](#). In previous editions, the effect of a [comparefn](#) result that is not a Number value was [implementation-defined](#). In practice, implementations call [ToNumber](#).

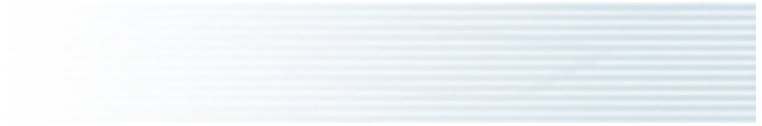

## Annex F

(informative)

### Additions and Changes That Introduce Incompatibilities with Prior Editions

6.2.5: In ECMAScript 2015, Function calls are not allowed to return a [Reference Record](#).

7.1.4.1: In ECMAScript 2015, [ToNumber](#) applied to a String value now recognizes and converts *BinaryIntegerLiteral* and *OctalIntegerLiteral* numeric strings. In previous editions such strings were converted to **NaN**.

9.3: In ECMAScript 2018, Template objects are canonicalized based on [Parse Node](#) (source location), instead of across all occurrences of that template literal or tagged template in a [Realm](#) in previous editions.

12.2: In ECMAScript 2016, Unicode 8.0.0 or higher is mandated, as opposed to ECMAScript 2015 which mandated Unicode 5.1. In particular, this caused U+180E MONGOLIAN VOWEL SEPARATOR, which was in the **Space\_Separator** (**Zs**) category and thus treated as whitespace in ECMAScript 2015, to be moved to the **Format** (**Cf**) category (as of Unicode 6.3.0). This causes whitespace-sensitive methods to behave differently. For example, `"\u180E".trim().length` was **0** in previous editions, but **1** in ECMAScript 2016 and later. Additionally, ECMAScript 2017 mandated always using the latest version of the Unicode Standard.

12.7: In ECMAScript 2015, the valid code points for an *IdentifierName* are specified in terms of the Unicode properties “ID\_Start” and “ID\_Continue”. In previous editions, the valid *IdentifierName* or *Identifier* code points were specified by enumerating various Unicode code point categories.

12.10.1: In ECMAScript 2015, Automatic Semicolon Insertion adds a semicolon at the end of a do-while statement if the semicolon is missing. This change aligns the specification with the actual behaviour of most existing implementations.

13.2.5.1: In ECMAScript 2015, it is no longer an [early error](#) to have duplicate property names in Object Initializers.

13.15.1: In ECMAScript 2015, [strict mode code](#) containing an assignment to an immutable binding such as the function name of a *FunctionExpression* does not produce an [early error](#). Instead it produces a runtime error.

14.2: In ECMAScript 2015, a *StatementList* beginning with the token `let` followed by the input elements *LineTerminator* then *Identifier* is the start of a *LexicalDeclaration*. In previous editions, automatic semicolon insertion would always insert a semicolon before the *Identifier* input element.

14.5: In ECMAScript 2015, a *StatementListItem* beginning with the token `let` followed by the token `[` is the start of a *LexicalDeclaration*. In previous editions such a sequence would be the start of an *ExpressionStatement*.

14.6.2: In ECMAScript 2015, the normal result of an *IfStatement* is never the value empty. If no *Statement* part is evaluated or if the evaluated *Statement* part produces a [normal completion containing](#) empty, the result of the *IfStatement* is **undefined**.

14.7: In ECMAScript 2015, if the `(` token of a for statement is immediately followed by the token sequence `let [` then the `let` is treated as the start of a *LexicalDeclaration*. In previous editions such a token sequence would be the start of an *Expression*.

14.7: In ECMAScript 2015, if the `(` token of a for-in statement is immediately followed by the token sequence **let** `[` then the **let** is treated as the start of a *ForDeclaration*. In previous editions such a token sequence would be the start of an *LeftHandSideExpression*.

14.7: Prior to ECMAScript 2015, an initialization expression could appear as part of the *VariableDeclaration* that precedes the **in** keyword. In ECMAScript 2015, the *ForBinding* in that same position does not allow the occurrence of such an initializer. In ECMAScript 2017, such an initializer is permitted only in [non-strict code](#).

14.7: In ECMAScript 2015, the result of evaluating an *IterationStatement* is never a [normal completion](#) whose `[[Value]]` is empty. If the *Statement* part of an *IterationStatement* is not evaluated or if the final evaluation of the *Statement* part produces a [normal completion](#) whose `[[Value]]` is empty, the result of evaluating the *IterationStatement* is a [normal completion](#) whose `[[Value]]` is **undefined**.

14.11.2: In ECMAScript 2015, the result of evaluating a *WithStatement* is never a [normal completion](#) whose `[[Value]]` is empty. If evaluation of the *Statement* part of a *WithStatement* produces a [normal completion](#) whose `[[Value]]` is empty, the result of evaluating the *WithStatement* is a [normal completion](#) whose `[[Value]]` is **undefined**.

14.12.4: In ECMAScript 2015, the result of evaluating a *SwitchStatement* is never a [normal completion](#) whose `[[Value]]` is empty. If evaluation of the *CaseBlock* part of a *SwitchStatement* produces a [normal completion](#) whose `[[Value]]` is empty, the result of evaluating the *SwitchStatement* is a [normal completion](#) whose `[[Value]]` is **undefined**.

14.15: In ECMAScript 2015, it is an [early error](#) for a *Catch* clause to contain a **var** declaration for the same *Identifier* that appears as the *Catch* clause parameter. In previous editions, such a variable declaration would be instantiated in the enclosing variable environment but the declaration's *Initializer* value would be assigned to the *Catch* parameter.

14.15, 19.2.1.3: In ECMAScript 2015, a runtime **SyntaxError** is thrown if a *Catch* clause evaluates a non-strict direct **eval** whose eval code includes a **var** or **FunctionDeclaration** declaration that binds the same *Identifier* that appears as the *Catch* clause parameter.

14.15.3: In ECMAScript 2015, the result of a *TryStatement* is never the value empty. If the *Block* part of a *TryStatement* evaluates to a [normal completion containing](#) empty, the result of the *TryStatement* is **undefined**. If the *Block* part of a *TryStatement* evaluates to a [throw completion](#) and it has a *Catch* part that evaluates to a [normal completion containing](#) empty, the result of the *TryStatement* is **undefined** if there is no *Finally* clause or if its *Finally* clause evaluates to an empty [normal completion](#).

15.4.5 In ECMAScript 2015, the [function objects](#) that are created as the values of the `[[Get]]` or `[[Set]]` attribute of [accessor properties](#) in an *ObjectLiteral* are not [constructor](#) functions and they do not have a **"prototype"** own property. In the previous edition, they were [constructors](#) and had a **"prototype"** property.

20.1.2.6: In ECMAScript 2015, if the argument to **Object.freeze** is not an object it is treated as if it was a non-extensible [ordinary object](#) with no own properties. In the previous edition, a non-object argument always causes a **TypeError** to be thrown.

20.1.2.8: In ECMAScript 2015, if the argument to **Object.getPrototypeOf** is not an object an attempt is made to coerce the argument using [ToObject](#). If the coercion is successful the result is used in place of the original argument value. In the previous edition, a non-object argument always causes a **TypeError** to be thrown.

20.1.2.10: In ECMAScript 2015, if the argument to **Object.getPrototypeOf** is not an object an attempt is made to coerce the argument using [ToObject](#). If the coercion is successful the result is used in place of the original argument value. In the previous edition, a non-object argument always causes a **TypeError** to be thrown.

20.1.2.12: In ECMAScript 2015, if the argument to **Object.getPrototypeOf** is not an object an attempt is made to coerce the argument using [ToObject](#). If the coercion is successful the result is used in place of the original argument value. In the previous edition, a non-object argument always causes a **TypeError** to be thrown.



**20.1.2.15:** In ECMAScript 2015, if the argument to **Object.isExtensible** is not an object it is treated as if it was a non-extensible [ordinary object](#) with no own properties. In the previous edition, a non-object argument always causes a **TypeError** to be thrown.

**20.1.2.16:** In ECMAScript 2015, if the argument to **Object.isFrozen** is not an object it is treated as if it was a non-extensible [ordinary object](#) with no own properties. In the previous edition, a non-object argument always causes a **TypeError** to be thrown.

**20.1.2.17:** In ECMAScript 2015, if the argument to **Object.isSealed** is not an object it is treated as if it was a non-extensible [ordinary object](#) with no own properties. In the previous edition, a non-object argument always causes a **TypeError** to be thrown.

**20.1.2.18:** In ECMAScript 2015, if the argument to **Object.keys** is not an object an attempt is made to coerce the argument using [ToObject](#). If the coercion is successful the result is used in place of the original argument value. In the previous edition, a non-object argument always causes a **TypeError** to be thrown.

**20.1.2.19:** In ECMAScript 2015, if the argument to **Object.preventExtensions** is not an object it is treated as if it was a non-extensible [ordinary object](#) with no own properties. In the previous edition, a non-object argument always causes a **TypeError** to be thrown.

**20.1.2.21:** In ECMAScript 2015, if the argument to **Object.seal** is not an object it is treated as if it was a non-extensible [ordinary object](#) with no own properties. In the previous edition, a non-object argument always causes a **TypeError** to be thrown.

**20.2.3.2:** In ECMAScript 2015, the `[[Prototype]]` internal slot of a bound function is set to the `[[GetPrototypeOf]]` value of its target function. In the previous edition, `[[Prototype]]` was always set to `%Function.prototype%`.

**20.2.4.1:** In ECMAScript 2015, the **"length"** property of function instances is configurable. In previous editions it was non-configurable.

**20.5.6.2:** In ECMAScript 2015, the `[[Prototype]]` internal slot of a [NativeError constructor](#) is the [Error constructor](#). In previous editions it was the [Function prototype object](#).

**21.4.4** In ECMAScript 2015, the [Date prototype object](#) is not a Date instance. In previous editions it was a Date instance whose `TimeValue` was **NaN**.

**22.1.3.11** In ECMAScript 2015, the **String.prototype.localeCompare** function must treat Strings that are canonically equivalent according to the Unicode Standard as being identical. In previous editions implementations were permitted to ignore canonical equivalence and could instead use a bit-wise comparison.

**22.1.3.27** and **22.1.3.29** In ECMAScript 2015, lowercase/upper conversion processing operates on code points. In previous editions such the conversion processing was only applied to individual code units. The only affected code points are those in the Deseret block of Unicode.

**22.1.3.30** In ECMAScript 2015, the **String.prototype.trim** method is defined to recognize white space code points that may exist outside of the Unicode BMP. However, as of Unicode 7 no such code points are defined. In previous editions such code points would not have been recognized as white space.

**22.2.4.1** In ECMAScript 2015, If the [pattern](#) argument is a RegExp instance and the [flags](#) argument is not **undefined**, a new RegExp instance is created just like [pattern](#) except that [pattern](#)'s flags are replaced by the argument [flags](#). In previous editions a **TypeError** exception was thrown when [pattern](#) was a RegExp instance and [flags](#) was not **undefined**.

**22.2.6** In ECMAScript 2015, the [RegExp prototype object](#) is not a RegExp instance. In previous editions it was a RegExp instance whose pattern is the empty String.

**22.2.6** In ECMAScript 2015, **"source"**, **"global"**, **"ignoreCase"**, and **"multiline"** are [accessor properties](#) defined on the [RegExp prototype object](#). In previous editions they were [data properties](#) defined on RegExp instances.

[25.4.13](#): In ECMAScript 2019, **Atomsics.wake** has been renamed to **Atomsics.notify** to prevent confusion with **Atomsics.wait**.

[27.1.4.4](#), [27.6.3.6](#): In ECMAScript 2019, the number of **Jobs** enqueued by **await** was reduced, which could create an observable difference in resolution order between a **then()** call and an **await** expression.

## Bibliography

1. *IEEE 754-2019: IEEE Standard for Floating-Point Arithmetic*. Institute of Electrical and Electronic Engineers, New York (2019)

NOTE There are no normative changes between IEEE 754-2008 and IEEE 754-2019 that affect the ECMA-262 specification.

2. *The Unicode Standard*, available at <<https://unicode.org/versions/latest>>
3. *Unicode Technical Note #5: Canonical Equivalence in Applications*, available at <<https://unicode.org/notes/tn5/>>
4. *Unicode Technical Standard #10: Unicode Collation Algorithm*, available at <<https://unicode.org/reports/tr10/>>
5. *Unicode Standard Annex #15, Unicode Normalization Forms*, available at <<https://unicode.org/reports/tr15/>>
6. *Unicode Standard Annex #18: Unicode Regular Expressions*, available at <<https://unicode.org/reports/tr18/>>
7. *Unicode Standard Annex #24: Unicode **Script** Property*, available at <<https://unicode.org/reports/tr24/>>
8. *Unicode Standard Annex #31, Unicode Identifiers and Pattern Syntax*, available at <<https://unicode.org/reports/tr31/>>
9. *Unicode Standard Annex #44: Unicode Character Database*, available at <<https://unicode.org/reports/tr44/>>
10. *Unicode Technical Standard #51: Unicode Emoji*, available at <<https://unicode.org/reports/tr51/>>
11. *IANA Time Zone Database*, available at <<https://www.iana.org/time-zones>>
12. ISO 8601:2004(E) *Data elements and interchange formats — Information interchange — Representation of dates and times*
13. *RFC 1738 “Uniform Resource Locators (URL)”*, available at <<https://tools.ietf.org/html/rfc1738>>
14. *RFC 2396 “Uniform Resource Identifiers (URI): Generic Syntax”*, available at <<https://tools.ietf.org/html/rfc2396>>
15. *RFC 3629 “UTF-8, a transformation format of ISO 10646”*, available at <<https://tools.ietf.org/html/rfc3629>>
16. *RFC 7231 “Hypertext Transfer Protocol (HTTP/1.1): Semantics and Content”*, available at <<https://tools.ietf.org/html/rfc7231>>

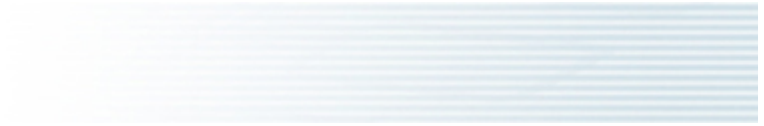

## Software License

All Software contained in this document ("Software") is protected by copyright and is being made available under the "BSD License", included below. This Software may be subject to third party rights (rights from parties other than Ecma International), including patent rights, and no licenses under such third party rights are granted under this license even if the third party concerned is a member of Ecma International. SEE THE ECMA CODE OF CONDUCT IN PATENT MATTERS AVAILABLE AT <https://ecma-international.org/memento/codeofconduct.htm> FOR INFORMATION REGARDING THE LICENSING OF PATENT CLAIMS THAT ARE REQUIRED TO IMPLEMENT ECMA INTERNATIONAL STANDARDS.

Redistribution and use in source and binary forms, with or without modification, are permitted provided that the following conditions are met:

1. Redistributions of source code must retain the above copyright notice, this list of conditions and the following disclaimer.
2. Redistributions in binary form must reproduce the above copyright notice, this list of conditions and the following disclaimer in the documentation and/or other materials provided with the distribution.
3. Neither the name of the authors nor Ecma International may be used to endorse or promote products derived from this software without specific prior written permission.

THIS SOFTWARE IS PROVIDED BY THE ECMA INTERNATIONAL "AS IS" AND ANY EXPRESS OR IMPLIED WARRANTIES, INCLUDING, BUT NOT LIMITED TO, THE IMPLIED WARRANTIES OF MERCHANTABILITY AND FITNESS FOR A PARTICULAR PURPOSE ARE DISCLAIMED. IN NO EVENT SHALL ECMA INTERNATIONAL BE LIABLE FOR ANY DIRECT, INDIRECT, INCIDENTAL, SPECIAL, EXEMPLARY, OR CONSEQUENTIAL DAMAGES (INCLUDING, BUT NOT LIMITED TO, PROCUREMENT OF SUBSTITUTE GOODS OR SERVICES; LOSS OF USE, DATA, OR PROFITS; OR BUSINESS INTERRUPTION) HOWEVER CAUSED AND ON ANY THEORY OF LIABILITY, WHETHER IN CONTRACT, STRICT LIABILITY, OR TORT (INCLUDING NEGLIGENCE OR OTHERWISE) ARISING IN ANY WAY OUT OF THE USE OF THIS SOFTWARE, EVEN IF ADVISED OF THE POSSIBILITY OF SUCH DAMAGE.

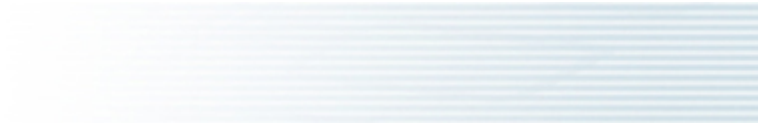

## Colophon

This specification is authored on [GitHub](#) in a plaintext source format called [Eckmarkup](#). Eckmarkup is an HTML and Markdown dialect that provides a framework and toolset for authoring ECMAScript specifications in plaintext and processing the specification into a full-featured HTML rendering that follows the editorial conventions for this document. Eckmarkup builds on and integrates a number of other formats and technologies including [Grammarkdown](#) for defining syntax and [Eckmarkdown](#) for authoring algorithm steps. Beginning with the thirteenth edition, PDF renderings of this specification are produced by augmenting the generated HTML with additional attributes and CSS rules defined by the W3C *CSS Paged Media* and *CSS Generated Content for Paged Media* specifications. The augmented HTML is “printed” as a PDF document using a web browser and the Paged.js JavaScript polyfill library.

Prior editions of this specification were authored using Word—the Eckmarkup source text that formed the basis of this edition was produced by converting the ECMAScript 2015 Word document to Eckmarkup using an automated conversion tool.

